

REV	LOCATIONS	DESCRIPTION	DATE	REVISED	APPD

SPECIFICATIONS

Electrical
 Current Rating: 0.5A AC(rms)/DC
 Voltage Rating: 50V AC(rms)/DC
 Contact Resistance: 20 mΩ Max
 Insulation Resistance: 500 MΩ MIN
 Withstanding Voltage: 500V AC r.m.s
 Operating Temperature: -40°C~+85°C

Material
 Housing: PA6T UL 94V-0
 Actuator: Heat Resistant Polymer UL 94V-0
 Contact: Phosphor Bronze/ Tin or gold plated

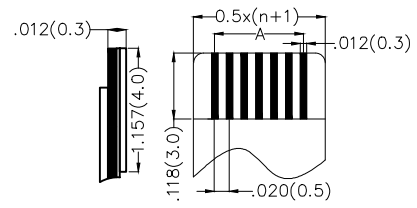
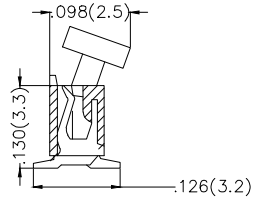
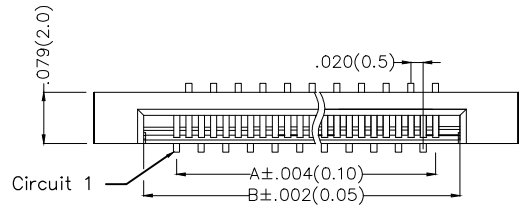

Applicable FFC Recommended Dimension

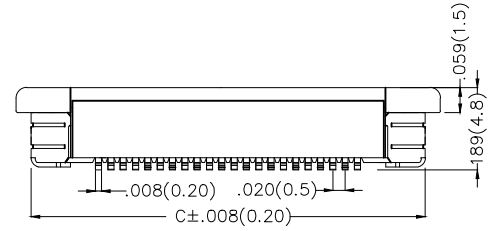

Ordering Information

FFC 050 12 — XX S S A 1 X 4 W5 M
 1 2 3 4 5 6 7 8 9 10 11 12

1 Category FFC-FPC	2 Series Number 050-Pitch0.50mm	3 Distinction No. 12	4 Circuits XX	5 Assemble Layout S-SMT	6 Entry Angle S-180° Vertical
7 Contact Position A-Positive Needle	8 ZIF 1-ZIF	9 Plating 2-Tin Plated 1-Gold Plated	10 Material-Resin 4-PA6T	11 Color-Resin W5-Housing: Natural, Actuator: Black	12 Packaging M-Reel

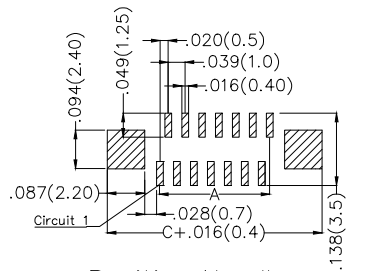

Positive Needle

Recommended P.C.Board Layout

<p>THIRD ANGLE PROJECTION</p>	GENERAL TOLERANCES (UNLESS SPECIFIED)		APPROVE BY FRANK	DATE 18/JUN/13	PART NO. FFC05012-XXSSA1X4W5M	ITEM NO. FFC05012	<p>Leader Of Industry</p>
	DESIGN UNITS Inch (metric)	X.±.012(0.30) X.X±.008(0.20)	X.±5° .X'±2°	CHECKED BY CHERRY	DATE 18/JUN/13	TITLE FPC/FFC connector 0.5mm Positive needle SMT	
SCALE 5:1	SIZE A4	X.XX±.006(0.15) X.XXX±.004(0.10)	.XX±1° .XXX±0.5°	DRAWN BY KEVIN	DATE 18/JUN/13	THIS DRAWING CONTAINS INFORMATION THAT IS PROPRIETARY TO TXGA INDUSTRIAL ELECTRONICS(S.Z)CO.,LTD AND SHOULD NOT BE USED WITHOUT WRITTEN PERMISSION	

1 2 3 4 5 6 7 8

REV	LOCATIONS	DESCRIPTION	DATE	REVSER	APPD

A

A

B

B

C

C

D

D



E

E

F

F

Circuits (n)	Part No.	Dimensions(in/mm)			Circuits (n)	Part No.	Dimensions(in/mm)		
		A	B	C			A	B	C
4	FFC05012-04SSA1X4W5M	.059(1.50)	.102(2.60)	.256(6.50)	20	FFC05012-20SSA1X4W5M	.374(9.50)	.417(10.60)	.571(14.50)
5	FFC05012-05SSA1X4W5M	.079(2.00)	.122(3.10)	.276(7.00)	21	FFC05012-21SSA1X4W5M	.394(10.00)	.437(11.10)	.591(15.00)
6	FFC05012-06SSA1X4W5M	.098(2.50)	.142(3.60)	.295(7.50)	22	FFC05012-22SSA1X4W5M	.413(10.50)	.457(11.60)	.610(15.50)
7	FFC05012-07SSA1X4W5M	.118(3.00)	.161(4.10)	.315(8.00)	24	FFC05012-24SSA1X4W5M	.453(11.50)	.496(12.60)	.650(16.50)
8	FFC05012-08SSA1X4W5M	.138(3.50)	.171(4.60)	.335(8.50)	25	FFC05012-25SSA1X4W5M	.472(12.00)	.516(13.10)	.689(17.00)
9	FFC05012-09SSA1X4W5M	.157(4.00)	.201(5.10)	.354(9.00)	26	FFC05012-26SSA1X4W5M	.492(12.50)	.535(13.60)	.689(17.50)
10	FFC05012-10SSA1X4W5M	.177(4.50)	.221(5.60)	.374(9.50)	27	FFC05012-27SSA1X4W5M	.512(13.00)	.555(14.10)	.709(18.00)
11	FFC05012-11SSA1X4W5M	.197(5.00)	.240(6.10)	.394(10.00)	28	FFC05012-28SSA1X4W5M	.531(13.50)	.575(14.60)	.728(18.50)
12	FFC05012-12SSA1X4W5M	.217(5.50)	.260(6.60)	.413(10.50)	29	FFC05012-29SSA1X4W5M	.551(14.00)	.595(15.10)	.748(19.00)
13	FFC05012-13SSA1X4W5M	.236(6.00)	.280(7.10)	.433(11.00)	30	FFC05012-30SSA1X4W5M	.571(14.50)	.614(15.60)	.768(19.50)
14	FFC05012-14SSA1X4W5M	.256(6.50)	.299(7.60)	.453(11.50)	32	FFC05012-32SSA1X4W5M	.610(15.50)	.654(16.60)	.807(20.50)
15	FFC05012-15SBA1X4W5M	.276(7.00)	.319(8.10)	.472(12.00)	33	FFC05012-33SSA1X4W5M	.630(16.00)	.673(17.10)	.827(21.00)
16	FFC05012-16SSA1X4W5M	.295(7.50)	.339(8.60)	.492(12.50)	34	FFC05001-34SSA1X4W5M	.650(16.50)	.693(17.60)	.846(21.50)
17	FFC05012-17SSA1X4W5M	.315(8.00)	.359(9.10)	.512(13.00)	35	FFC05012-35SSA1X4W5M	.669(17.00)	.713(18.10)	.866(22.00)
18	FFC05012-18SSA1X4W5M	.335(8.50)	.378(9.60)	.531(13.50)	36	FFC05012-36SSA1X4W5M	.689(17.50)	.732(18.60)	.886(22.50)
19	FFC05012-19SSA1X4W5M	.354(9.00)	.398(10.10)	.551(14.00)	40	FFC05012-40SSA1X4W5M	.768(19.50)	.811(20.60)	.965(24.50)

 THIRD ANGLE PROJECTION	GENERAL TOLERANCES (UNLESS SPECIFIED)		APPROVE BY FRANK	DATE 18/JUN/13	PART NO. FFC05012-XXSSA1X4W5M	ITEM NO. FFC05012	 Leader Of Industry	
	X.±.012(0.30)	X.±5'	CHECKED BY CHERRY	DATE 18/JUN/13	TITLE FFC/FFC connector 0.5mm Positive needle SMT	REV 0		SHEET NO. 2/5
	DESIGN UNITS Inch (metric)	X.X±.008(0.20)	.X±2'	DRAWN BY KEVIN	DATE 18/JUN/13	THIS DRAWING CONTAINS INFORMATION THAT IS PROPRIETARY TO TXGA INDUSTRIAL ELECTRONICS(S.Z)CO.,LTD AND SHOULD NOT BE USED WITHOUT WRITTEN PERMISSION		
	SCALE 5:1	SIZE A4	X.XX±.006(0.15)	.XX±1'	X.XXX±.004(0.10)	.XX±0.5'		

1 2 3 4 5 6 7 8

REV	LOCATIONS	DESCRIPTION	DATE	REVISED	APPD

SPECIFICATIONS

Electrical
 Current Rating: 0.5A AC(rms)/DC
 Voltage Rating: 50V AC(rms)/DC
 Contact Resistance: 20 mΩ Max
 Insulation Resistance: 500 MΩ MIN
 Withstanding Voltage: 500V AC r.m.s
 Operating Temperature: -40°C~+85°C

Material
 Housing: PA6T UL 94V-0
 Actuator: Heat Resistant Polymer UL 94V-0
 Contact: Phosphor Bronze/ Tin or gold plated

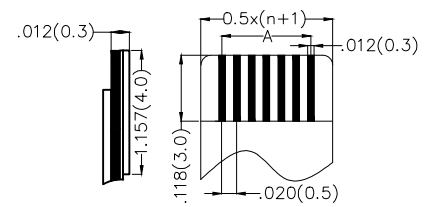
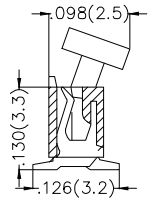
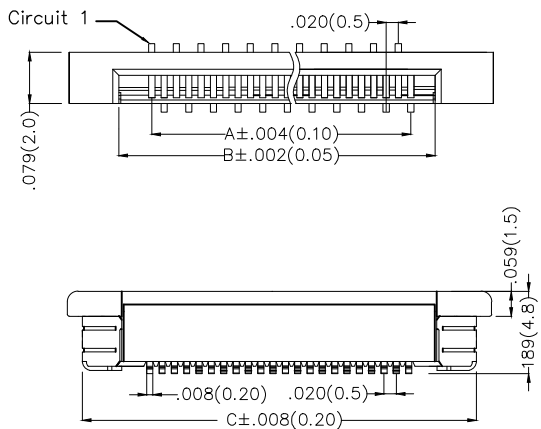

Applicable FFC
Recommended Dimension

Ordering Information

FFC 050 12 — XX S S B 1 X 4 W5 M
 1 2 3 4 5 6 7 8 9 10 11 12

1 Category FFC-FPC	2 Series Number 050-Pitch 0.50mm	3 Distinction No. 12	4 Circuits XX	5 Assemble Layout S-SMT	6 Entry Angle S-180° Vertical
7 Contact Position B-Versa Needle	8 ZIF 1-ZIF	9 Plating 2-Tin Plated 1-Gold Plated	10 Material-Resin 4-PA6T	11 Color-Resin W5-Housing: Natural, Actuator: Black	12 Packaging M-Reel

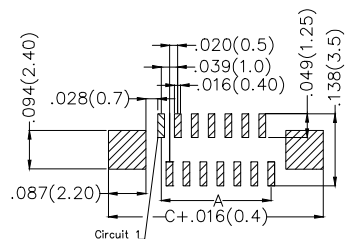

Versa Needle
Recommended P.C.Board Layout

 THIRD ANGLE PROJECTION	GENERAL TOLERANCES (UNLESS SPECIFIED)		APPROVE BY FRANK	DATE 18/JUN/13	PART NO. FFC05012-XXSSB1X4W5M	ITEM NO. FFC05012	 Leader Of Industry	
	DESIGN UNITS Inch (metric)	X.±.012(0.30) X.X±.008(0.20)	X.±5° .X'±2°	CHECKED BY CHERRY	DATE 18/JUN/13	TITLE FPC/FFC connector 0.5mm Versa needle SMT		REV 0
SCALE 5:1	SIZE A4	X.XX±.006(0.15) X.XXX±.004(0.10)	.XX'±1° .XXX'±0.5°	DRAWN BY KEVIN	DATE 18/JUN/13	THIS DRAWING CONTAINS INFORMATION THAT IS PROPRIETARY TO TXGA INDUSTRIAL ELECTRONICS(S.Z)CO.,LTD AND SHOULD NOT BE USED WITHOUT WRITTEN PERMISSION		

1 2 3 4 5 6 7 8

REV	LOCATIONS	DESCRIPTION	DATE	REVISED	APPD

A

A

B

B

C

C

D

D



E

E

F

F

Circuits (n)	Part No.	Dimensions(in/mm)			Circuits (n)	Part No.	Dimensions(in/mm)		
		A	B	C			A	B	C
4	FFC05012-04SSB1X4W5M	.059(1.50)	.102(2.60)	.256(6.50)	20	FFC05012-20SSB1X4W5M	.374(9.50)	.417(10.60)	.571(14.50)
5	FFC05012-05SSB1X4W5M	.079(2.00)	.122(3.10)	.276(7.00)	21	FFC05012-21SSB1X4W5M	.394(10.00)	.437(11.10)	.591(15.00)
6	FFC05012-06SSB1X4W5M	.098(2.50)	.142(3.60)	.295(7.50)	22	FFC05012-22SSB1X4W5M	.413(10.50)	.457(11.60)	.610(15.50)
7	FFC05012-07SSB1X4W5M	.118(3.00)	.161(4.10)	.315(8.00)	24	FFC05012-24SSB1X4W5M	.453(11.50)	.496(12.60)	.650(16.50)
8	FFC05012-08SSB1X4W5M	.138(3.50)	.171(4.60)	.335(8.50)	25	FFC05012-25SSB1X4W5M	.472(12.00)	.516(13.10)	.689(17.00)
9	FFC05012-09SSB1X4W5M	.157(4.00)	.201(5.10)	.354(9.00)	26	FFC05012-26SSB1X4W5M	.492(12.50)	.535(13.60)	.689(17.50)
10	FFC05012-10SSB1X4W5M	.177(4.50)	.221(5.60)	.374(9.50)	27	FFC05012-27SSB1X4W5M	.512(13.00)	.555(14.10)	.709(18.00)
11	FFC05012-11SSB1X4W5M	.197(5.00)	.240(6.10)	.394(10.00)	28	FFC05012-28SSB1X4W5M	.531(13.50)	.575(14.60)	.728(18.50)
12	FFC05012-12SSB1X4W5M	.217(5.50)	.260(6.60)	.413(10.50)	29	FFC05012-29SSB1X4W5M	.551(14.00)	.595(15.10)	.748(19.00)
13	FFC05012-13SSB1X4W5M	.236(6.00)	.280(7.10)	.433(11.00)	30	FFC05012-30SSB1X4W5M	.571(14.50)	.614(15.60)	.768(19.50)
14	FFC05012-14SSB1X4W5M	.256(6.50)	.299(7.60)	.453(11.50)	32	FFC05012-32SSB1X4W5M	.610(15.50)	.654(16.60)	.807(20.50)
15	FFC05012-15SSB1X4W5M	.276(7.00)	.319(8.10)	.472(12.00)	33	FFC05012-33SSB1X4W5M	.630(16.00)	.673(17.10)	.827(21.00)
16	FFC05012-16SSB1X4W5M	.295(7.50)	.339(8.60)	.492(12.50)	34	FFC05001-34SSB1X4W5M	.650(16.50)	.693(17.60)	.846(21.50)
17	FFC05012-17SSB1X4W5M	.315(8.00)	.359(9.10)	.512(13.00)	35	FFC05012-35SSB1X4W5M	.669(17.00)	.713(18.10)	.866(22.00)
18	FFC05012-18SSB1X4W5M	.335(8.50)	.378(9.60)	.531(13.50)	36	FFC05012-36SSB1X4W5M	.689(17.50)	.732(18.60)	.886(22.50)
19	FFC05012-19SSB1X4W5M	.354(9.00)	.398(10.10)	.551(14.00)	40	FFC05012-40SSB1X4W5M	.768(19.50)	.811(20.60)	.965(24.50)

 THIRD ANGLE PROJECTION	GENERAL TOLERANCES (UNLESS SPECIFIED)		APPROVE BY FRANK	DATE 18/JUN/13	PART NO. FFC05012-XXSSB1X4W5M	ITEM NO. FFC05012	 Leader Of Industry
	DESIGN UNITS Inch (metric)	X.±.012(0.30)	X.±5'	CHECKED BY CHERRY	DATE 18/JUN/13	TITLE FFC/FFC connector 0.5mm Versa needle SMT	
SCALE 5:1	SIZE A4	X.XX±.006(0.15)	.XX±1'	DRAWN BY KEVIN	DATE 18/JUN/13	THIS DRAWING CONTAINS INFORMATION THAT IS PROPRIETARY TO TXGA INDUSTRIAL ELECTRONICS(S.Z)CO.,LTD AND SHOULD NOT BE USED WITHOUT WRITTEN PERMISSION	

1 2 3 4 5 6 7 8

REV	LOCATIONS	DESCRIPTION	DATE	REVISER	APPD

A
B
C
D
E
F

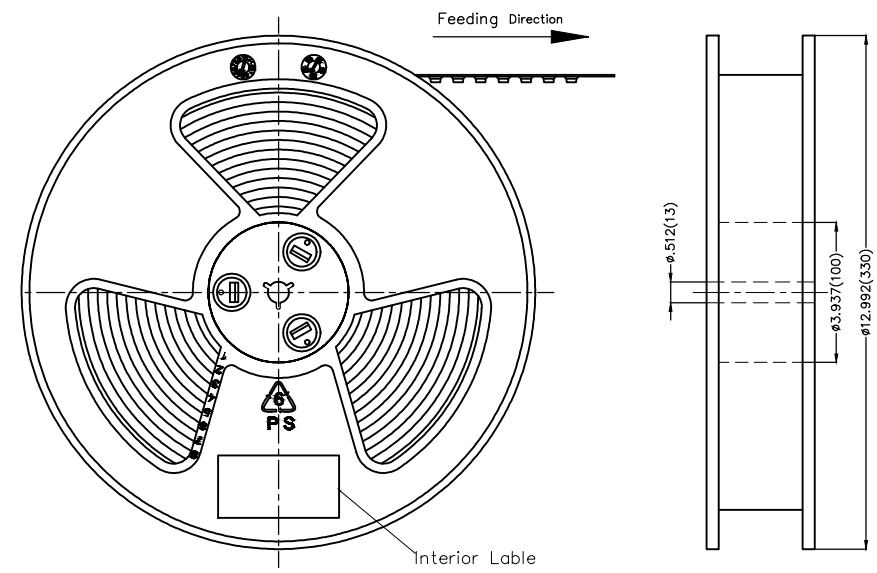

- Note:
1. 10 sprocket hole cumulative tolerance ± 0.2
 2. Carrier camber is within 1.0mm in 250mm
 3. Material: White Conductive polystyrene Alloy 100% recyclable
 4. All dimensions meet EIA-481-3 requirements
 5. Peel off force of cover tape & carrier tape: 20g~130g (0.2N~1.3N)
 6. Component load per 13" reel: 1,000 pcs

Circuits (n)	Dimensions (in/mm)		
	A	B	C
4~16	.945(24.0)	.453(11.50)	—
17~24	1.260(32.0)	.561(14.25)	1.122(28.50)
25~40	1.732(44.0)	.797(20.25)	1.594(40.50)

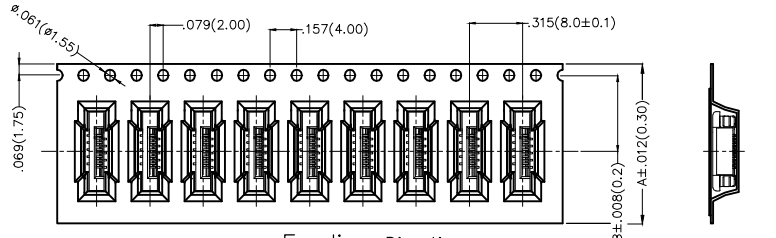

Circuits: 4-16 Feeding Direction

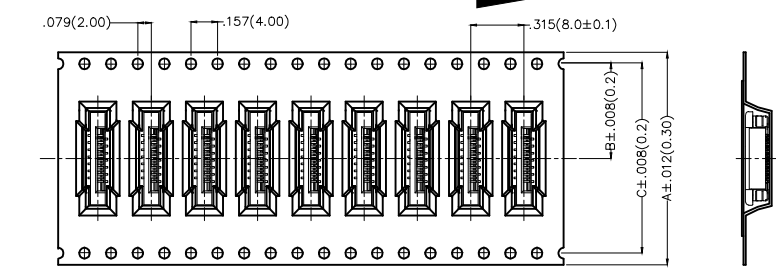

Circuits: 17-40 Feeding Direction

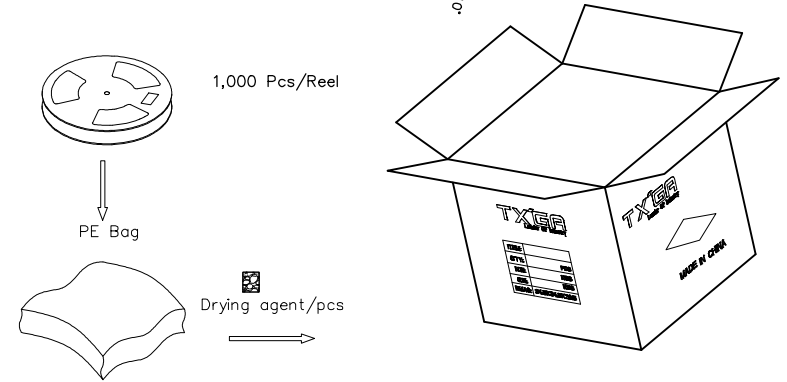
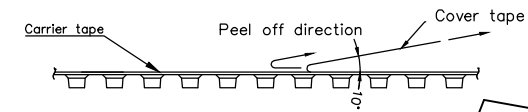
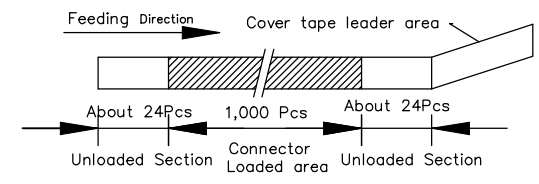

<p>THIRD ANGLE PROJECTION</p>	GENERAL TOLERANCES (UNLESS SPECIFIED)		APPROVE BY	DATE	PART NO.	ITEM NO.	<p>Leader Of Industry</p>
	X. \pm .012(0.30)	X. \pm 5'	FRANK	18/JUN/13	FFC05012-XXSSX1X4W5M	FFC05012	
	X.X \pm .008(0.20)	.X \pm 2'	CHECKED BY	DATE	TITLE		REV 0
	X.XX \pm .006(0.15)	.XX \pm 1'	CHERRY	18/JUN/13	FPC/FFC connector 0.5mm SMT		SHEET NO. 5/5
SCALE	SIZE	X.XXX \pm .004(0.10)	.XXX \pm 0.5'	DRAWN BY	DATE	THIS DRAWING CONTAINS INFORMATION THAT IS PROPRIETARY TO TXGA INDUSTRIAL ELECTRONICS(S.Z)CO.,LTD AND SHOULD NOT BE USED WITHOUT WRITTEN PERMISSION	
5:1	A4	KEVIN	18/JUN/13				

X-ON Electronics

Largest Supplier of Electrical and Electronic Components

Click to view similar products for [FFC & FPC Connectors](#) category:

Click to view products by [TXGA](#) manufacturer:

Other Similar products are found below :

[HFW11R-1STE1H1LF](#) [FH29B-100S-0.2SHW\(99\)](#) [FA5S008HP1](#) [FH29B-120S-0.2SHW\(99\)](#) [FH29B-80S-0.2SHW\(99\)](#) [FHS-16](#) [FPH-2022G](#)
[52610-1075](#) [52610-1275](#) [52610-1934](#) [XF3M\(1\)-1415-1B-R100](#) [501864-3091-TR225](#) [0525594033](#) [086210010340800](#) [086222026001800](#)
[52271-2869-CUT-TAPE](#) [62674-201121DLF](#) [62684-36210E9ALF](#) [52610-1675](#) [52746-1671-TR250](#) [10051922-2810EHLF](#) [6-520415-9](#)
[BD021-09A-A1-0350-0200-0550-LD](#) [SFV6R-1STE9HLF](#) [XF3M-2915-1B-R100](#) [1658549-1](#) [62674-221121ALF](#) [46214008010800](#)
[046298003000883](#) [151660622](#) [842-816-2630-035](#) [AYF530665TA](#) [AYF351525](#) [046296011930846+](#) [AYF352325A](#) [046254020000800+](#)
[FH19C-13S-0.5SH\(99\)](#) [FH39J-51S-0.3SHW\(99\)](#) [AYF355125A](#) [AYF530365TA](#) [FH29B-44S-0.2SHW\(99\)](#) [SFW5R-2STAE9LF](#) [AYF351125A](#)
[AYF350725A](#) [62684-502100AHLF](#) [FH39-61S-0.3SHW\(99\)](#) [AYF414035A](#) [10064555-172520HLF](#) [AYF212335A](#) [504754-2500](#)