

REV	LOCATIONS	DESCRIPTION	DATE	REVISER	APPD
1	△	1. Dimension: Change 2.62 into 3.25mm 2. Part No.: Change FRJ4598 into FRJ45050	01/JUN/18	Vandy	Eric

SPECIFICATIONS

Electrical

Current Rating: 1.5A AC(rms)/DC
Voltage Rating: 125V AC(rms)/DC
Contact Resistance: 40 mΩ Max
Insulation Resistance: 1000 MΩ Min / DC 500V
Withstanding Voltage: 1000V AC r.m.s
Operating Temperature: -20°C~+75°C
Durability: 750 Cycles Min.

Material and Plating

Housing: Thermoplastic UL94V-0, Black
Contact: Phosphor Bronze/ Gold Plated
Shell: Brass/ Nickel Plated

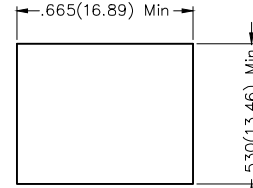
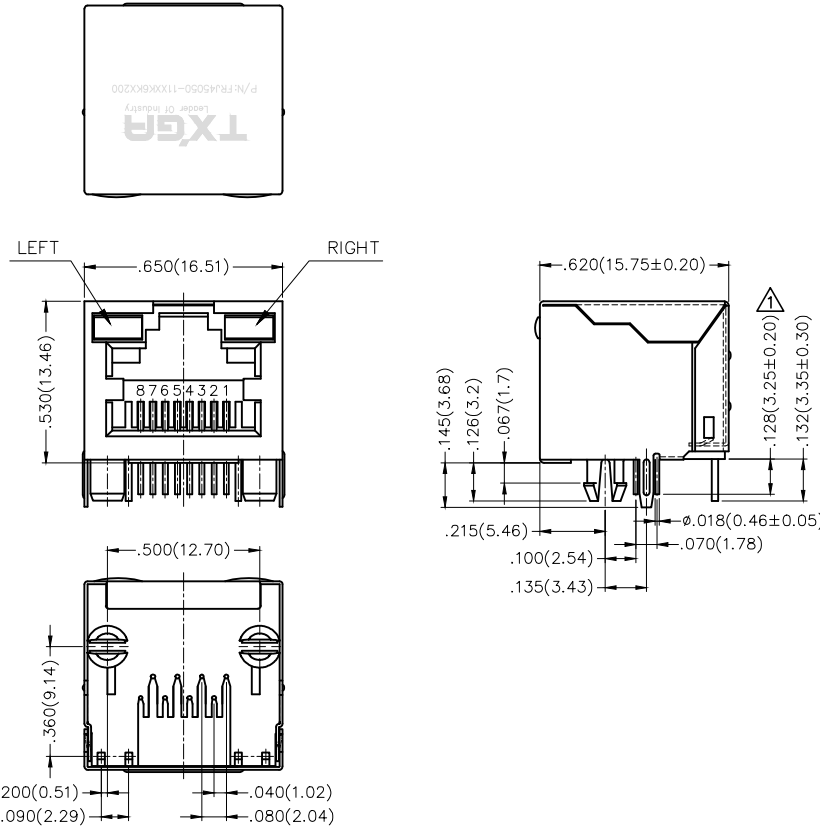

Circuits	Left	Circuits	Right
11	-	9	-
12	+	10	+

Recommended Panel Cutout

Ordering Information

FRJ45 050 - 1 1 XX K6 K X 2 0 0
1 2 3 4 5 6 7 8 9

1 Category FRJ45-RJ45 Connector	2 Distinction No. 050	3 Ports options 1-1 Port	4 Plating 1-Gold Plated	5 Thickness of plating 00-Gold flash 03-3μ" Custom plate available
6 Color-Resin K6-Black	7 Packaging K-Tray	8 LED style 1-L: Yellow R: Green 2-L: Green R: Yellow	9 Contact type 2-Round pin	

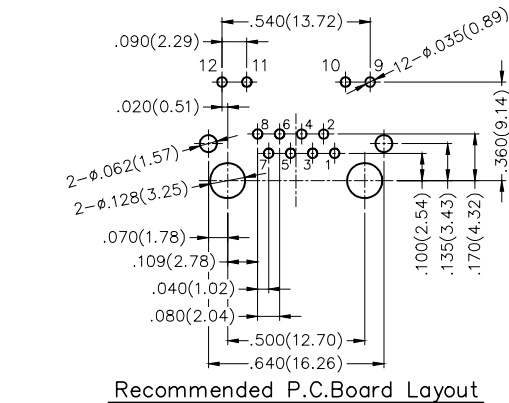

Recommended P.C. Board Layout

THIRD ANGLE PROJECTION	GENERAL TOLERANCES (UNLESS SPECIFIED)		APPROVE BY FRANK	DATE 18/JUN/13	PART NO. △ FRJ45050-11XXK6KX200	ITEM NO. FRJ45050	 Leader Of Industry
	DESIGN UNITS Inch (metric)	X.±.012(0.30) X'.±5'	CHECKED BY CHERRY	DATE 18/JUN/13	TITLE RJ45 Connector 8P8C 90° Angle		
SCALE 5:1	SIZE A4	X.XX±.006(0.15) .XX'±1"	DRAWN BY KATE	DATE 18/JUN/13	THIS DRAWING CONTAINS INFORMATION THAT IS PROPRIETARY TO TXGA INDUSTRIAL ELECTRONICS(S.Z)CO.,LTD AND SHOULD NOT BE USED WITHOUT WRITTEN PERMISSION		

REV	LOCATIONS	DESCRIPTION	DATE	REVISER	APPD
1	△	1. Dimension: Change 2.62 into 2.90mm 2. Part No.: Change FRJ4598 into FRJ45050	01/JUN/18	Vandy	Eric

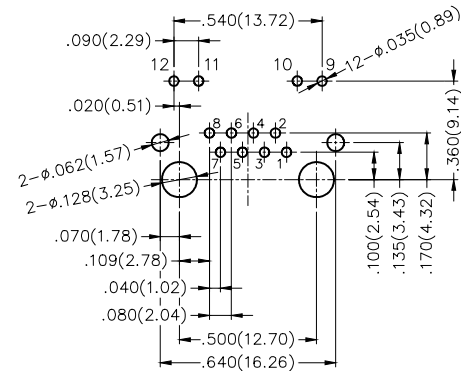
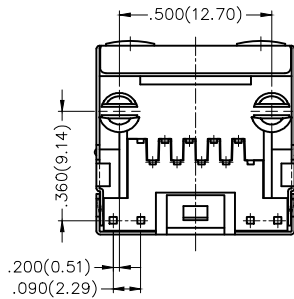
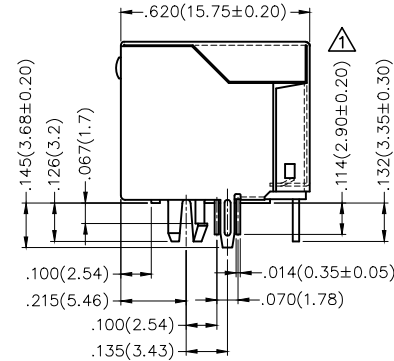
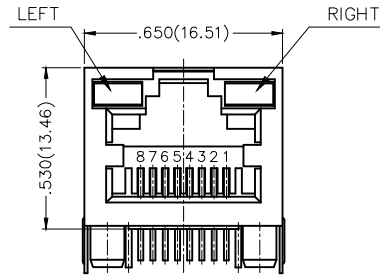
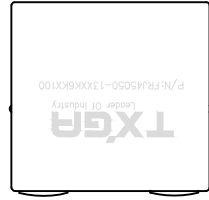

SPECIFICATIONS

Electrical

Current Rating: 1.5A AC(rms)/DC
Voltage Rating: 125V AC(rms)/DC
Contact Resistance: 40 mΩ Max
Insulation Resistance: 1000 MΩ Min / DC 500V
Withstanding Voltage: 1000V AC r.m.s
Operating Temperature: -20°C~+75°C
Durability: 750 Cycles Min.

Material and Plating

Housing: PBT UL94V-0, Black
Contact: Phosphor Bronze/ Selective gold in contact area, tin on tail
Shell: Brass/ Nickel Plated

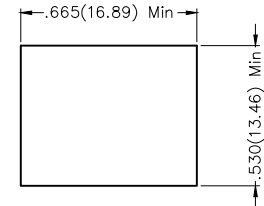

Recommended Panel Cutout

Circuits	Left	Circuits	Right
11	-	9	-
12	+	10	+

Ordering Information

FRJ45 050 - 1 3 XX K6 K X 1 0 0
1 2 3 4 5 6 7 8 9

1 Category FRJ45-RJ45 Connector	2 Distinction No. 050	3 Ports options 1-1 Port	4 Plating 3-Selective gold in contact area, tin on tail	5 Thickness of plating 00-Gold flash 06-6μ" Custom plate available
6 Color-Resin K6-Black	7 Packaging K-Tray	8 LED style 1-L: Yellow R: Green 2-L: Green R: Yellow	9 Contact type 1-Square pin	

Recommended P.C.Board Layout

THIRD ANGLE PROJECTION	GENERAL TOLERANCES (UNLESS SPECIFIED)		APPROVE BY FRANK	DATE 18/JUN/13	PART NO. △ FRJ45050-13XXK6KX100	ITEM NO. FRJ45050	 Leader Of Industry
	DESIGN UNITS Inch (metric)	X.±.012(0.30) X'.±5'	CHECKED BY CHERRY	DATE 18/JUN/13	TITLE RJ45 Connector 8P8C 90° Angle		
SCALE 5:1	SIZE A4	X.XX±.006(0.15) .XX±1"	DRAWN BY KATE	DATE 18/JUN/13	THIS DRAWING CONTAINS INFORMATION THAT IS PROPRIETARY TO TXGA INDUSTRIAL ELECTRONICS(S,Z)CO.,LTD AND SHOULD NOT BE USED WITHOUT WRITTEN PERMISSION		

X-ON Electronics

Largest Supplier of Electrical and Electronic Components

Click to view similar products for [Modular Connectors](#) / [Ethernet Connectors](#) category:

Click to view products by [TXGA](#) manufacturer:

Other Similar products are found below :

[8949-H88/06BLKA/SN](#) [74441-0010/BKN](#) [PHP-6P6C-5](#) [GAX-3-66](#) [GAX-8-62](#) [GDCX-PN-66](#) [GLX-A-44](#) [GLX-N-1010M-BLK](#) [GMX-SMT4-N-88](#) [GSGX-N-2-88](#) [GSGX-N-4-88](#) [GSX-NS2-88-3.05](#) [GSX-NS-88-3.68](#) [PT-108A-8C-UL](#) [PTS-J531-8CS-50UL](#) [A-2014-0-4](#) [GWLX-S9-88-YG](#) [DC-1021-8-WH-6](#) [1300530003](#) [1324640-4](#) [RJ11FTVC2G](#) [RJ11FTVC2N](#) [RJFTVX2SA1G](#) [132764-001](#) [1413235](#) [MPS88RX-5000](#) [E5288-S000K3-L](#) [155302-001](#) [AX101050](#) [AX101063](#) [AX101065](#) [AX101072](#) [AX101307](#) [AX101314](#) [AX101315](#) [AX101318](#) [AX102271](#) [AX102288](#) [AX102651](#) [AX102660](#) [J0012D21NL](#) [J0026D01ENL](#) [PC4D0018P](#) [8949-B88/6](#) [2-6609208-5](#) [937-SP-3088-2PC-A192](#) [303066VFL](#) [303068V](#) [303088LFLSA](#) [303088SBL](#)