

1 2 3 4 5 6 7 8

REV	LOCATIONS	DESCRIPTION	DATE	REVISER	APPD
1		Structural and material changes	15/APR/20	KATE	CHERRY

SPECIFICATIONS

Electrical

Current Rating: 0.5A AC(rms)/DC
 Voltage Rating: 30V AC(rms)/DC
 Contact Resistance: 20 mΩ Max
 Insulation Resistance: 100 MΩ Min
 Withstanding Voltage: 200V AC r.m.s
 Temperature Range—Operating: -40°C~+105°C

Material and Plating

Housing: LCP (UL 94V-0)
 Contact: Phosphor bronze/ Gold flash or Tin plated
 Solder Tab: Brass/ Gold flash or Tin plated

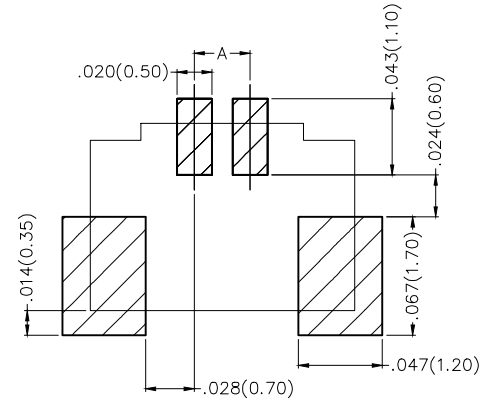
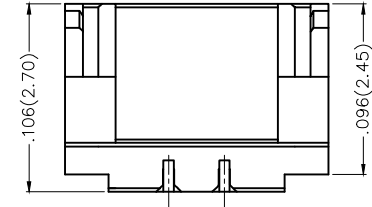
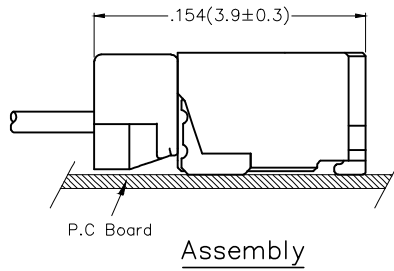
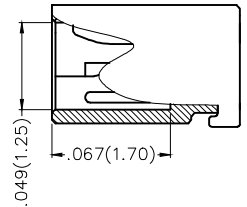
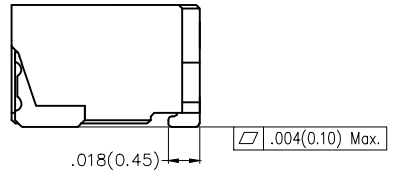
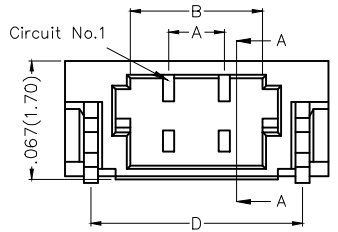
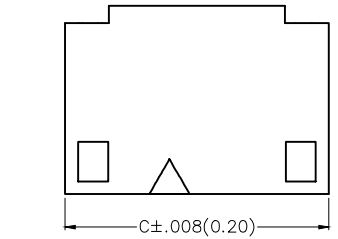

Recommended P.C.Board Layout
 General tolerances: ±.002(0.05)

Ordering Information

FWF 080 02 — S XX B X 3 W5 M
 1 2 3 4 5 6 7 8 9 10

1	Category FWF—Wafer	2	Series Number 080—Pitch0.8mm	3	Distinction No. 02	4	Row Option S—Single Row	5	Circuits XX
6	Entry Angle B—90° Angle	7	Plating 1—Gold Plated 2—Tin Plated	8	Material—Resin 3—LCP	9	Color—Resin W5—Natural	10	Packaging M—Reel

<p>THIRD ANGLE PROJECTION</p>	GENERAL TOLERANCES (UNLESS SPECIFIED)		APPROVE BY FRANK	DATE 28/JUN/13	PART NO. FWF08002—SXXBX3W5M	ITEM NO. FWF08002	<p>Leader Of Industry</p>
	X.±.012(0.30)	X.±5°	CHECKED BY JACOB	DATE 28/JUN/13	TITLE Wire to Board (Wafer) Pitch 0.8mm 90° Angle (SMT)		
DESIGN UNITS Inch (metric)	X.X±.008(0.20)	.X'±2°	DRAWN BY CHERRY	DATE 28/JUN/13	THIS DRAWING CONTAINS INFORMATION THAT IS PROPRIETARY TO TXGA INDUSTRIAL ELECTRONICS(S.Z)CO.,LTD AND SHOULD NOT BE USED WITHOUT WRITTEN PERMISSION		
SCALE 5:1	SIZE A4	X.XX±.006(0.15)					
		X.XXX±.004(0.10)					

1 2 3 4 5 6 7 8

1 2 3 4 5 6 7 8

REV	LOCATIONS	DESCRIPTION	DATE	REVISER	APPD

A

A

B

B

C

C

D

D



E

E

F

F

Circuits (n)	Part No.	Dimensions(in/mm)			
		A	B	C	D
2	FWF08002-S02BX3W5M	.031(0.80)	.075(1.90)	.149(3.78)	.120(3.04)
3	FWF08002-S03BX3W5M	.063(1.60)	.106(2.70)	.180(4.58)	.151(3.84)
4	FWF08002-S04BX3W5M	.094(2.40)	.138(3.50)	.212(5.38)	.183(4.64)
5	FWF08002-S05BX3W5M	.126(3.20)	.169(4.30)	.243(6.18)	.214(5.44)
6	FWF08002-S06BX3W5M	.157(4.00)	.201(5.10)	.275(6.98)	.246(6.24)
7	FWF08002-S07BX3W5M	.189(4.80)	.232(5.90)	.306(7.78)	.277(7.04)
8	FWF08002-S08BX3W5M	.220(5.60)	.264(6.70)	.338(8.58)	.309(7.84)
9	FWF08002-S09BX3W5M	.252(6.40)	.295(7.50)	.369(9.38)	.340(8.64)
10	FWF08002-S10BX3W5M	.283(7.20)	.327(8.30)	.401(10.18)	.372(9.44)
12	FWF08002-S12BX3W5M	.346(8.80)	.390(9.90)	.464(11.78)	.435(11.04)
14	FWF08002-S14BX3W5M	.409(10.40)	.453(11.50)	.527(13.38)	.498(12.64)
16	FWF08002-S16BX3W5M	.472(12.00)	.516(13.10)	.590(14.98)	.561(14.24)
20	FWF08002-S20BX3W5M	.598(15.20)	.642(16.30)	.716(18.18)	.687(17.44)

 THIRD ANGLE PROJECTION	GENERAL TOLERANCES (UNLESS SPECIFIED)		APPROVE BY FRANK	DATE 28/JUN/13	PART NO. FWF08002-SXXBX3W5M	ITEM NO. FWF08002	 Leader Of Industry
	DESIGN UNITS Inch (metric)	X.±.012(0.30) X.X±.008(0.20) X.XX±.006(0.15) X.XXX±.004(0.10)	X.±5° .X°±2° .XX°±1° .XXX±0.5°	CHECKED BY JACOB	DATE 28/JUN/13	TITLE Wire to Board (Wafer) Pitch 0.8mm 90° Angle (SMT)	
SCALE 5:1	SIZE A4	DRAWN BY CHERRY		DATE 28/JUN/13	THIS DRAWING CONTAINS INFORMATION THAT IS PROPRIETARY TO TXGA INDUSTRIAL ELECTRONICS(S.Z)CO.,LTD AND SHOULD NOT BE USED WITHOUT WRITTEN PERMISSION		REV 1 SHEET NO. 2/3

1 2 3 4 5 6 7 8

REV	LOCATIONS	DESCRIPTION	DATE	REVISER	APPD

Note:

- 10 sprocket hole cumulative tolerance ± 0.2
- Carrier camber is within 1.0mm in 250mm
- Material: White Conductive polystyrene Alloy 100% recyclable
- All dimensions meet EIA-481-3 requirements
- Peel off force of cover tape & carrier tape: 20g~130g(0.2N~1.3N)
- Component load per 13" reel: 3,500 pcs

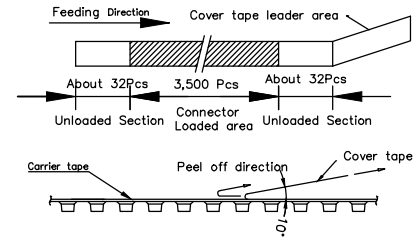
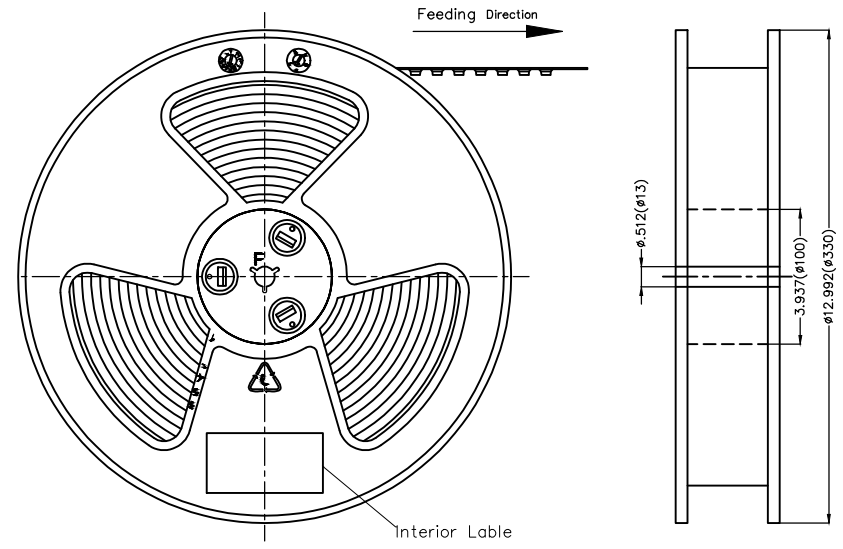

Circuits (n)	Dimensions(in./mm)		Circuits (n)	Dimensions(in./mm)	
	D	W		D	W
2	.295(7.50)	.630(16.00)	9	.295(7.50)	.630(16.00)
3	.295(7.50)	.630(16.00)	10	.453(11.50)	.945(24.00)
4	.295(7.50)	.630(16.00)	12	.453(11.50)	.945(24.00)
5	.295(7.50)	.630(16.00)	14	.453(11.50)	.945(24.00)
6	.295(7.50)	.630(16.00)	16	.453(11.50)	.945(24.00)
7	.295(7.50)	.630(16.00)	20	.453(11.50)	.945(24.00)
8	.295(7.50)	.630(16.00)			

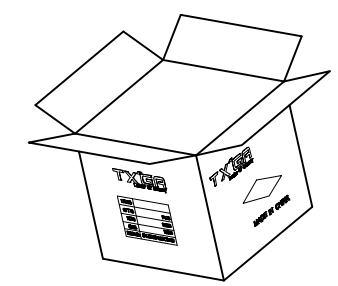
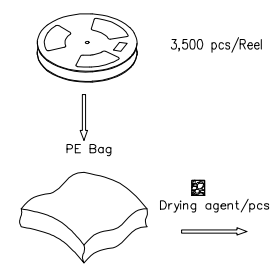
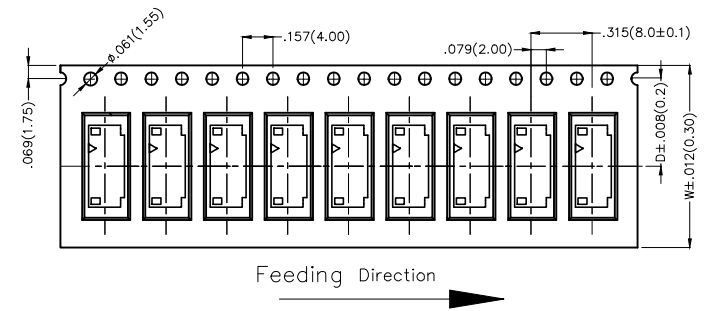

 THIRD ANGLE PROJECTION	GENERAL TOLERANCES (UNLESS SPECIFIED)		APPROVE BY	DATE	PART NO.	ITEM NO.	 Leader Of Industry
	X.±.012(0.30)	X.±5'	FRANK	28/JUN/13	FWF08002-SXXBX3W5M	FWF08002	
DESIGN UNITS Inch (metric)	X.X±.008(0.20)	.X'±2'	CHECKED BY	DATE	TITLE		REV 1 SHEET NO. 3/3
SCALE	X.XX±.006(0.15)	.XX'±1'	JACOB	28/JUN/13	Wire to Board (Wafer) Pitch 0.8mm 90° Angle (SMT)		
SIZE	X.XXX±.004(0.10)	.XXX'±0.5'	DRAWN BY	DATE	THIS DRAWING CONTAINS INFORMATION THAT IS PROPRIETARY TO TXGA INDUSTRIAL ELECTRONICS(S.Z)CO.,LTD AND SHOULD NOT BE USED WITHOUT WRITTEN PERMISSION		
5:1			CHERRY	28/JUN/13			

X-ON Electronics

Largest Supplier of Electrical and Electronic Components

Click to view similar products for [Headers & Wire Housings](#) category:

Click to view products by [TXGA](#) manufacturer:

Other Similar products are found below :

[57102-F02-18ULF](#) [58102-G61-06LF](#) [0009485154](#) [009176003701906](#) [0050291907](#) [02.125.8002.8](#) [609-3404](#) [61062-3](#) [622-0430](#) [622-3653LF](#)
[63453-116](#) [636-1030](#) [636-1427](#) [636-3427](#) [636-4007](#) [641938-9](#) [644827-2](#) [65495-038](#) [65692-001LF](#) [65781-018](#) [65781-047](#) [65817-010LF](#)
[65817-015LF](#) [66207-023LF](#) [67016-026LF](#) [67095-007LF](#) [68631-112](#) [68645-018](#) [68648-049](#) [699319-000](#) [70.362.1628.0](#) [70-4210](#) [70-4226B](#)
[70-4853B](#) [707-5020](#) [707-5028](#) [71.350.2428.0](#) [71961-016LF](#) [733-134](#) [754199-000](#) [760-3052](#) [787-8014-00](#) [FCN-367T-T012/H](#) [80.063.4001.1](#)
[800-90-010-10-002000](#) [801-43-002-10-013000](#) [801-43-006-10-002000](#) [803-41-018-10-001000](#) [803-43-014-20-001000](#) [803-43-024-10-001000](#)