

REV	LOCATIONS	DESCRIPTION	DATE	REVISER	APPD

Electrical
 Current Rating: 1A AC(rms)/DC
 Voltage Rating: 50V AC(rms)/DC
 Contact Resistance: 20 mΩ Max
 Insulation Resistance: 100 MΩ MIN
 Withstanding Voltage: 500V AC r.m.s
 Temperature Range—Operating: -25°C~+85°C
 Material and Plating
 Housing: PA9T (UL 94V-0)
 Contact Pin: Brass/ Tin plated
 Solder Tab: Copper alloy/ Tin plated

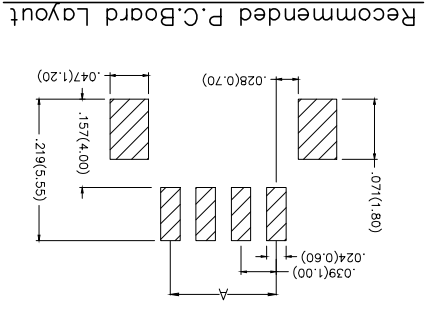
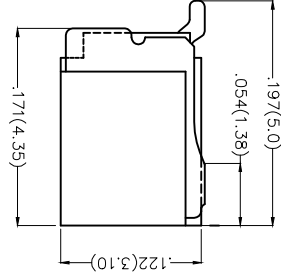
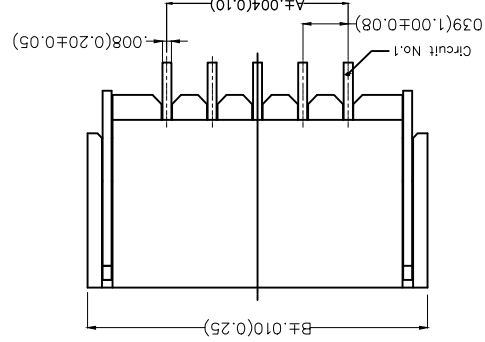
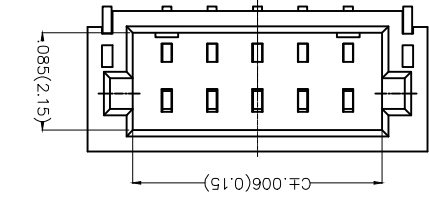

Recommended P.C.Board Layout

1	Category	FWF-Water	2	Series Number	100-Pitch:1.0mm
3	Distinction No.	01	3	Material-Resin	4-PA9T
4	Row Option	Single Row	9	Color-Resin	W5-White
5	Circuits	XX	10	Packaging	M-Reel
6	Entry Angle	B-90° Angle	7	Plating	2-Tin Plated

Ordering Information

1	FWF	100	01	-	S	XX	B	2	4	W5	M
2	100	01	01	01	01	XX	B	2	4	W5	M
3	100	01	01	01	01	XX	B	2	4	W5	M
4	100	01	01	01	01	XX	B	2	4	W5	M
5	100	01	01	01	01	XX	B	2	4	W5	M
6	100	01	01	01	01	XX	B	2	4	W5	M
7	100	01	01	01	01	XX	B	2	4	W5	M
8	100	01	01	01	01	XX	B	2	4	W5	M
9	100	01	01	01	01	XX	B	2	4	W5	M
10	100	01	01	01	01	XX	B	2	4	W5	M

APPROVE BY	FRANK	DATE	28/JUN/13	PART NO.	FWF10001-SXXB24W5M	ITEM NO.	FWF10001
CHECKED BY	JACOB	DATE	28/JUN/13	TITLE	Wire to Board (Water) Pitch 1.0mm 90° Angle (SMT)	REV	0
DRAWN BY	CHERRY	DATE	28/JUN/13	THIS DRAWING CONTAINS INFORMATION THAT IS PROPRIETARY TO TXGA INDUSTRIAL ELECTRONICS(SZ)CO.,LTD AND SHOULD NOT BE USED WITHOUT WRITTEN PERMISSION			
SCALE	5:1	SIZE	A4	GENERAL TOLERANCES (UNLESS SPECIFIED)			
DESIGN UNITS	Inch (metric)	X.XX±.008(0.20)	X.XX±.006(0.15)	X.XX±.004(0.10)	X.XX±.004(0.10)	X.XX±.004(0.10)	X.XX±.004(0.10)
THIRD ANGLE PROJECTION		X.XX±.012(0.30)	X.XX±.01	X.XX±.05	ELECTRONICS(SZ)CO.,LTD AND SHOULD NOT BE USED WITHOUT WRITTEN PERMISSION		



REV	LOCATIONS	DESCRIPTION	DATE	REVISER	APPD

Circuits	Part No.	Dimensions(in/mm)							
		A	B	C					
2	FWF10001-S02B24W5M	.039(1.00)	.177(4.50)	.102(2.60)					
3	FWF10001-S03B24W5M	.078(2.00)	.217(5.50)	.142(3.60)					
4	FWF10001-S04B24W5M	.118(3.00)	.256(6.50)	.181(4.60)					
5	FWF10001-S05B24W5M	.157(4.00)	.295(7.50)	.220(5.60)					
6	FWF10001-S06B24W5M	.197(5.00)	.335(8.50)	.260(6.60)					
7	FWF10001-S07B24W5M	.236(6.00)	.374(9.50)	.299(7.60)					
8	FWF10001-S08B24W5M	.276(7.00)	.413(10.50)	.339(8.60)					
9	FWF10001-S09B24W5M	.315(8.00)	.453(11.50)	.378(9.60)					
10	FWF10001-S10B24W5M	.354(9.00)	.492(12.50)	.417(10.60)					
Circuits	Part No.	A	B	C	(n)	FWF10001-S11B24W5M	.394(10.00)	.531(13.50)	.457(11.60)
						FWF10001-S12B24W5M	.433(11.00)	.571(14.50)	.496(12.60)
						FWF10001-S13B24W5M	.472(12.00)	.610(15.50)	.535(13.60)
						FWF10001-S14B24W5M	.512(13.00)	.650(16.50)	.575(14.60)
						FWF10001-S15B24W5M	.551(14.00)	.689(17.50)	.614(15.60)
						FWF10001-S16B24W5M	.591(15.00)	.728(18.50)	.654(16.60)
						FWF10001-S17B24W5M	.630(16.00)	.768(19.50)	.693(17.60)
						FWF10001-S18B24W5M	.669(17.00)	.807(20.50)	.732(18.60)
						FWF10001-S20B24W5M	.748(19.00)	.886(22.50)	.811(20.60)

 THIRD ANGLE PROJECTION		GENERAL TOLERANCES (UNLESS SPECIFIED) X.±.012(0.30) X.±.5	APPROVE BY FRANK	DATE 28/JUN/13	PART NO. FWF10001-SXXB24W5M ITEM NO. FWF10001	TITLE Wire to Board (Water) Pitch 1.0mm 90° Angle (SMT)	REV 0 SHEET NO. 2/3	THIS DRAWING CONTAINS INFORMATION THAT IS PROPRIETARY TO TXGA INDUSTRIAL ELECTRONICS(SZ)CO.,LTD AND SHOULD NOT BE USED WITHOUT WRITTEN PERMISSION
DESIGN UNITS Inch (metric)	SCALE 5:1 A4	X.X±.008(0.20) X.±.2	CHECKED BY JACOB	DATE 28/JUN/13				
X.X±.006(0.15) X.±.1	DRAWN BY CHERRY	X.X±.004(0.10) .XXX±0.5	DATE 28/JUN/13					

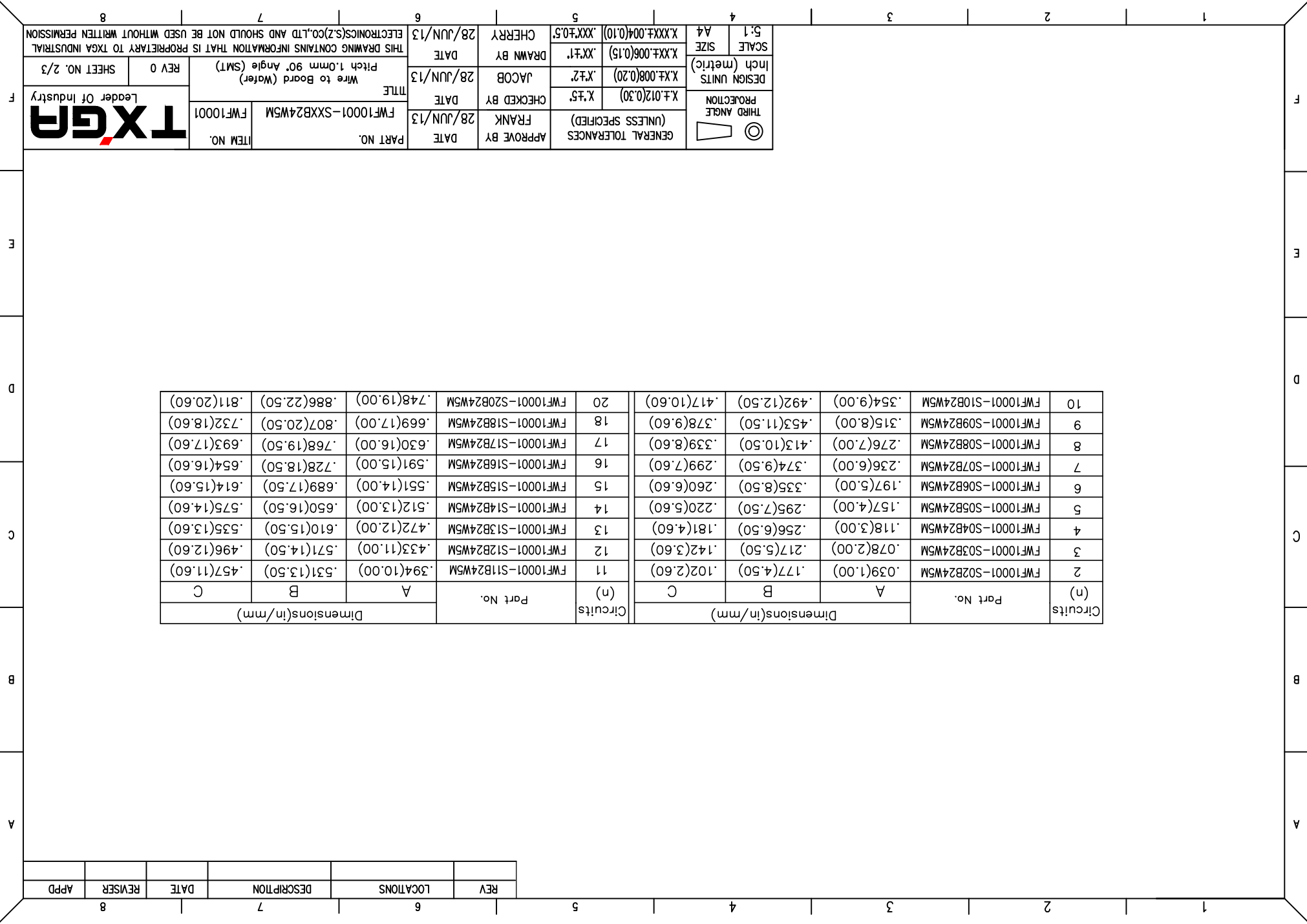

REV	LOCATIONS	DESCRIPTION	DATE	REVISER	APPD

Note:

- 10 sprocket hole cumulative tolerance±0.2
- Carrier camber is within 1.0mm in 250mm
- Material: White Conductive polystyrene Alloy 100% recyclable
- All dimensions meet EIA-481-3 requirements
- Peel off force of cover tape&carrier tape:20g~130g(0.2N~1.3N)
- Component load per 13" reel: 1,500 pcs

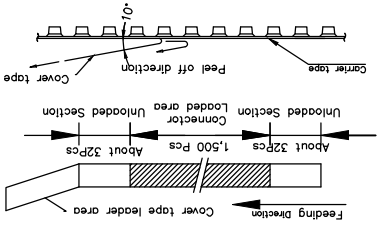

Circuits	Dimensions(in/mm)	
	D	W
(n)	D	W
2	.295(7.50)	.630(16.00)
3	.295(7.50)	.630(16.00)
4	.295(7.50)	.630(16.00)
5	.295(7.50)	.630(16.00)
6	.295(7.50)	.630(16.00)
7	.295(7.50)	.630(16.00)
8	.295(7.50)	.630(16.00)
9	.295(7.50)	.630(16.00)
10	.453(11.50)	.945(24.00)
11	.453(11.50)	.945(24.00)

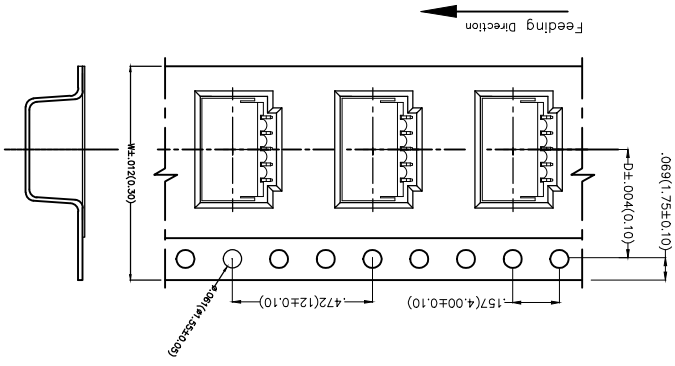
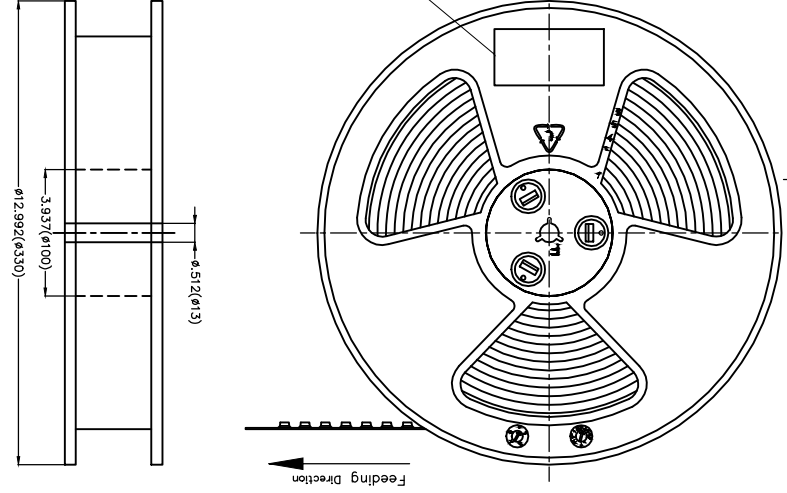
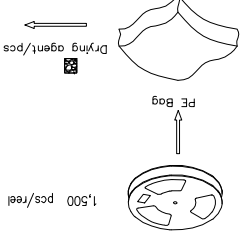
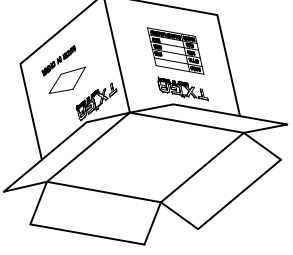

GENERAL TOLERANCES (UNLESS SPECIFIED)	APPROVE BY	DATE	PART NO.	ITEM NO.
X.±.012(0.30)	FRANK	28/JUN/13	FWF10001-SXXB24WSM	FWF10001
X.XX±.008(0.20)	CHECKED BY	DATE	TITLE	Leader Of Industry
X.XX±.006(0.15)	JACOB	28/JUN/13	Wire to Board (Water)	REV 0
X.XX±.004(0.10)	DRAWN BY	DATE	Pitch 1.0mm 90° Angle (SMT)	SHEET NO. 3/3
X.XX±.004(0.10)	CHEERY	28/JUN/13	THIS DRAWING CONTAINS INFORMATION THAT IS PROPRIETARY TO TXGA INDUSTRIAL ELECTRONICS(SZ)CO.,LTD AND SHOULD NOT BE USED WITHOUT WRITTEN PERMISSION	

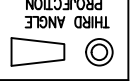

DESIGN UNITS	THIRD ANGLE
Inch (metric)	
SCALE	
A4	
5:1	



A B C D E F

1 2 3 4 5 6 7 8

X-ON Electronics

Largest Supplier of Electrical and Electronic Components

Click to view similar products for [Headers & Wire Housings](#) category:

Click to view products by [TXGA](#) manufacturer:

Other Similar products are found below :

[95000-104TRLF](#) [10135584-644402LF](#) [DF62W-EP2022PCA](#) [95000-106TRLF](#) [DF62W-2022SCA](#) [DF62W-EP2022PC](#) [2203348](#) [DF62W-2022SC](#) [1084018](#) [1029039](#) [1084017](#) [802-10-012-10-002000](#) [1112640](#) [1112639](#) [891-007-9SS-BST1T](#) [000-34000](#) [0008550134](#) [0009482033](#) [0009507031](#) [57102-F02-18ULF](#) [57102-S06-03LF](#) [57202-S52-04LF](#) [PCN6-15S-2.5E](#) [0039019024](#) [58102-G61-06LF](#) [582553-1](#) [0009485154](#) [0009508121](#) [0022285053](#) [0050291907](#) [018731A](#) [LY20-4P-DT1-P1E-BR](#) [02.125.8002.8](#) [60101931](#) [60598-1 \(Cut Strip\)](#) [M1625-3R/100](#) [61062-3](#) [61082-181009](#) [CSU011177004](#) [636-1427](#) [638009-1](#) [641938-9](#) [641991-4](#) [644168-1](#) [644827-2](#) [647662-1](#) [65039-019ELF](#) [65692-001LF](#) [65781-018](#) [65781-047](#)