

REV	LOCATIONS	DESCRIPTION	DATE	REVISER	APPD

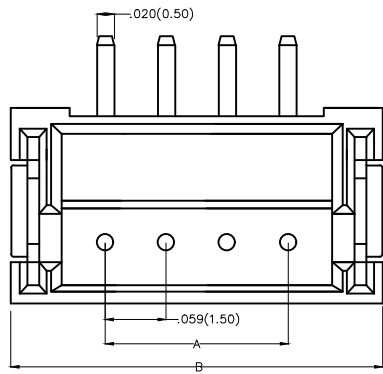

Electrical
 Current Rating: 1.0A AC(rms)/DC
 Voltage Rating: 50V AC(rms)/DC
 Contact Resistance: 20 mΩ Max
 Insulation Resistance: 500 MΩ MIN
 Withstanding Voltage: 500V AC r.m.s
 Temperature Range—Operating: -25°C~+85°C

Material and Plating
 Housing: PA9T(UL 94V-0)
 Contact Pin: Brass
 Plating: Tin Plated

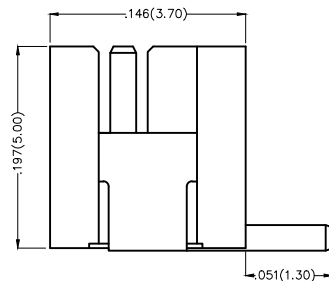
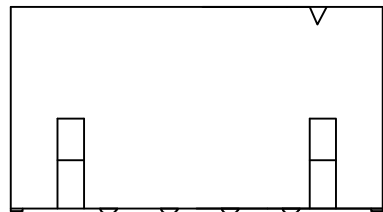

Ordering Information

FWF 150 05 - S XX S 2 4 W5 M
 1 2 3 4 5 6 7 8 9 10

1 Category FWF—Wafer	2 Series Number 150—Pitch1.5mm	3 Distinction No. 05	4 Row Option Single Row	5 Circuits XX	6 Entry Angle S—180° Vertical
7 Plating 2—Tin Plated	8 Material—Resin 4—PA9T	9 Color—Resin W5—White	10 Packaging M—Reel		

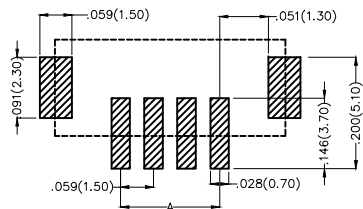



Recommended P.C.Board Layout

THIRD ANGLE PROJECTION	GENERAL TOLERANCES (UNLESS SPECIFIED)		APPROVE BY FRANK	DATE 8/JUL/13	PART NO. FWF15005-SXXS24W5M	ITEM NO. FWF15005	 Leader Of Industry
	DESIGN UNITS Inch (metric)	X.±.012(0.30) X.±5'	CHECKED BY JACOB	DATE 8/JUL/13	TITLE Wire to Board (Wafer) Pitch 1.5mm 180° Vertical (SMT)		
SCALE 5:1	SIZE A4	X.XX±.006(0.15) .XX±1'	DRAWN BY CHERRY	DATE 8/JUL/13	THIS DRAWING CONTAINS INFORMATION THAT IS PROPRIETARY TO TXGA INDUSTRIAL ELECTRONICS(S.Z.)CO.,LTD AND SHOULD NOT BE USED WITHOUT WRITTEN PERMISSION		

REV	LOCATIONS	DESCRIPTION	DATE	REVISER	APPD

Material and Plating : Housing PA9T UL94V-0, Tin Plated.

Circuits (n)	Part No.	Dimensions(in/mm)	
		A	B
2	FWF15005-S02S24W5M	.059(1.50)	.236(6.00)
3	FWF15005-S03S24W5M	.118(3.00)	.295(7.50)
4	FWF15005-S04S24W5M	.177(4.50)	.354(9.00)
5	FWF15005-S05S24W5M	.236(6.00)	.413(10.50)
6	FWF15005-S06S24W5M	.295(7.50)	.472(12.00)
7	FWF15005-S07S24W5M	.354(9.00)	.531(13.50)
8	FWF15005-S08S24W5M	.413(10.50)	.591(15.00)
9	FWF15005-S09S24W5M	.472(12.00)	.650(16.50)
10	FWF15005-S10S24W5M	.531(13.50)	.709(18.00)
11	FWF15005-S11S24W5M	.591(15.00)	.768(19.50)
12	FWF15005-S12S24W5M	.650(16.50)	.827(21.00)

 THIRD ANGLE PROJECTION	GENERAL TOLERANCES (UNLESS SPECIFIED)		APPROVE BY FRANK	DATE 8/JUL/13	PART NO. FWF15005-SXXS24W5M	ITEM NO. FWF15005	 Leader Of Industry	
	DESIGN UNITS Inch (metric)	X. \pm .012(0.30)	X. \pm 5'	CHECKED BY JACOB	DATE 8/JUL/13	TITLE Wire to Board (Wafer) Pitch 1.5mm 180° Vertical (SMT)		REV 0
SCALE 5:1	SIZE A4	X.XX \pm .006(0.15)	X.XX \pm 1'	DRAWN BY CHERRY	DATE 8/JUL/13	THIS DRAWING CONTAINS INFORMATION THAT IS PROPRIETARY TO TXGA INDUSTRIAL ELECTRONICS(S.Z)CO.,LTD AND SHOULD NOT BE USED WITHOUT WRITTEN PERMISSION		

REV	LOCATIONS	DESCRIPTION	DATE	REVISER	APPD

- Note:
1. 10 sprocket hole cumulative tolerance ± 0.2
 2. Carrier camber is within 1.0mm in 100mm
 3. Material: White Conductive polystyrene Alloy 100% recyclable
 4. All dimensions meet EIA-481-3 requirements
 5. Component load per 13" reel: 1,500pcs

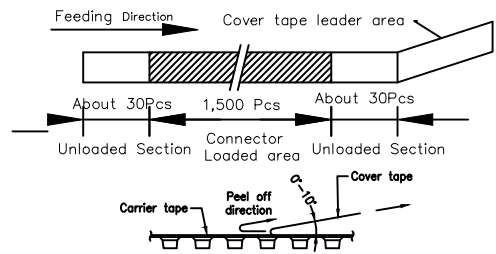
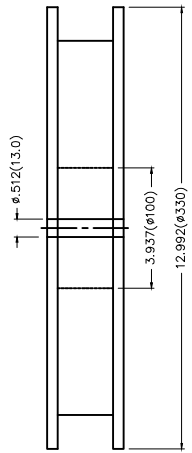
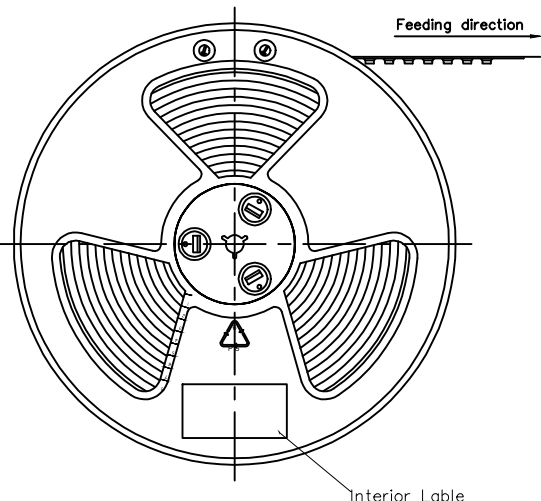

Pins	Dimensions(in./mm)	
	D	W
2	.295(7.50)	.630(16.00)
3	.295(7.50)	.630(16.00)
4	.453(11.50)	.945(24.00)
5	.453(11.50)	.945(24.00)
6	.453(11.50)	.945(24.00)
7	.559(14.20)	1.260(32.00)
8	.559(14.20)	1.260(32.00)
9	.559(14.20)	1.260(32.00)
10	.559(14.20)	1.260(32.00)
11	.559(14.20)	1.260(32.00)
12	.559(14.20)	1.260(32.00)

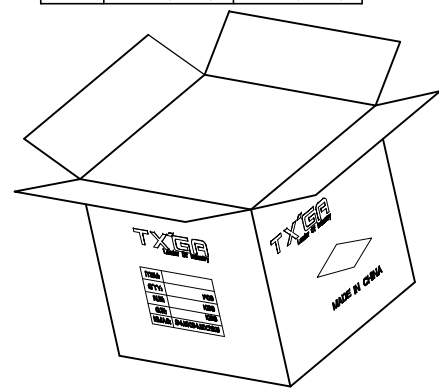
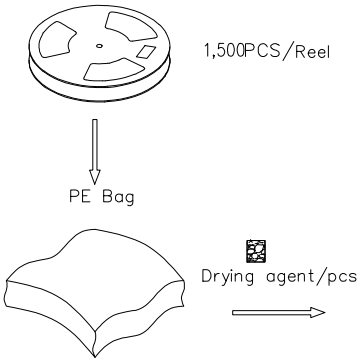
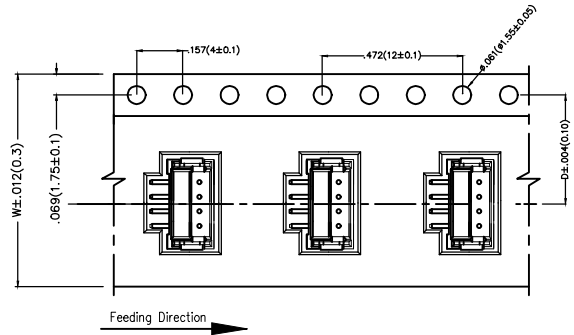

 THIRD ANGLE PROJECTION	GENERAL TOLERANCES (UNLESS SPECIFIED)		APPROVE BY	DATE	PART NO.	ITEM NO.	 Leader Of Industry	
	X.±.012(0.30)	X.±5'	FRANK	8/JUL/13	FWF15005-SXXS24W5M	FWF15005		
	DESIGN UNITS Inch (metric)	X.X±.008(0.20)	X.±2'	CHECKED BY	DATE	TITLE		THIS DRAWING CONTAINS INFORMATION THAT IS PROPRIETARY TO TXGA INDUSTRIAL ELECTRONICS(S.Z.)CO.,LTD AND SHOULD NOT BE USED WITHOUT WRITTEN PERMISSION
	SCALE	X.XX±.006(0.15)	.XX±1'	JACOB	8/JUL/13	Wire to Board (Wafer) Pitch 1.5mm 180° Vertical (SMT)		
SIZE	X.XXX±.004(0.10)	.XXX±0.5'	DRAWN BY	DATE	REV 0	SHEET NO. 2/2		
5:1	A4		CHERRY	8/JUL/13				

X-ON Electronics

Largest Supplier of Electrical and Electronic Components

Click to view similar products for [Headers & Wire Housings](#) category:

Click to view products by [TXGA](#) manufacturer:

Other Similar products are found below :

[0015917161](#) [0022155065](#) [57102-F02-18ULF](#) [58102-G61-06LF](#) [582553-1](#) [01.001.5753.1](#) [0050291907](#) [02.125.8002.8](#) [609-3404](#) [61062-3](#)
[CSU011177004](#) [622-0430](#) [622-3653LF](#) [63453-116](#) [636-1030](#) [636-1427](#) [636-3427](#) [636-4007](#) [641938-9](#) [65495-038](#) [65692-001LF](#) [65781-018](#)
[65781-047](#) [65817-010LF](#) [65817-015LF](#) [67095-007LF](#) [67601157](#) [68631-112](#) [68645-018](#) [699319-000](#) [70.362.1628.0](#) [70-4210](#) [70-4226B](#) [70-](#)
[4853B](#) [71.350.2428.0](#) [733-134](#) [733-162](#) [760-3052](#) [MHR-64-VUAL](#) [80.063.4001.1](#) [800-90-001-10-001000](#) [801-43-002-10-013000](#)
[801-43-006-10-002000](#) [803-43-024-10-001000](#) [803-93-012-10-001000](#) [8-1437020-4](#) [819-22-004-30-001101](#) [820-22-006-30-001101](#)
[820-22-008-30-001101](#) [821-22-002-10-001101](#)