

REV	LOCATIONS	DESCRIPTION	DATE	REVISER	APPD

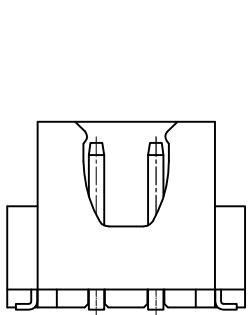

2Circuits

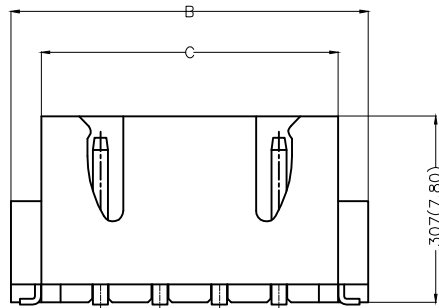

3-12Circuits

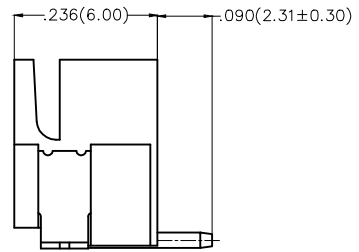

Electrical

Current Rating: 3.0A AC(rms)/DC  
Voltage Rating: 250V AC(rms)/DC  
Contact Resistance: 20 mΩ Max  
Insulation Resistance: 1000 MΩ MIN  
Withstanding Voltage: 1000V AC r.m.s  
Temperature Range—Operating: -25°C~+85°C

Material and Plating

Housing: PA9T( UL 94V-0)  
Contact Pin: Brass  
Plating: Tin Plated

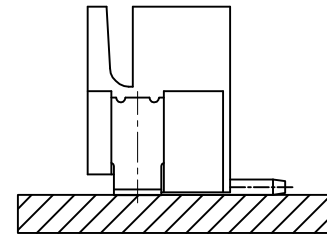

Assembly Layout

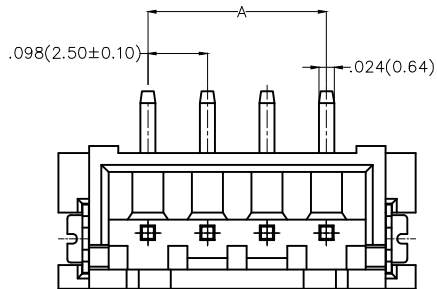

Ordering Information

FWF 250 28 — S XX S 2 4 W5 M  
1 2 3 4 5 6 7 8 9 10

1 Category FWF—Wafer	2 Series Number 250—Pitch 2.5mm	3 Distinction No. 28	4 Row Option Single Row	5 Circuits XX	6 Entry Angle S—180° Vertical
7 Plating 2—Tin Plated	8 Material—Resin 4—PA9T	9 Color—Resin W5—Natural	10 Packaging M—Reel		

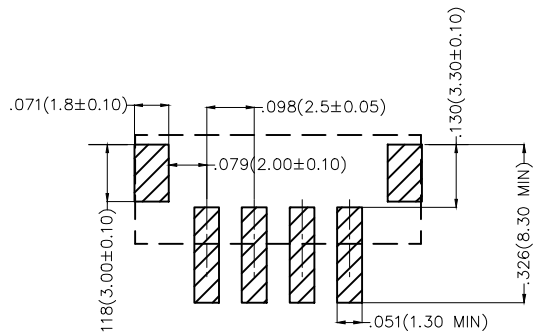



Recommended P.C.Board Layout

 THIRD ANGLE PROJECTION	GENERAL TOLERANCES (UNLESS SPECIFIED)		APPROVE BY FRANK	DATE 01/AUG/13	PART NO. FWF25028—SXXS24W5M	ITEM NO. FWF25028	 Leader Of Industry
	DESIGN UNITS Inch (metric)	X.X±.012(0.30) X'±5"	CHECKED BY CHERRY	DATE 01/AUG/13	TITLE Wire to Board (Wafer) Pitch 2.5mm 180° Vertical (SMT)		
SCALE 5:1	SIZE A4	X.XX±.006(0.15) .XX'±1"	DRAWN BY KEVIN	DATE 01/AUG/13	THIS DRAWING CONTAINS INFORMATION THAT IS PROPRIETARY TO TXGA INDUSTRIAL ELECTRONICS(S.Z)CO.,LTD AND SHOULD NOT BE USED WITHOUT WRITTEN PERMISSION		

REV	LOCATIONS	DESCRIPTION	DATE	REVISER	APPD

Material and Plating : Housing PA9T UL94V-0 , Tin Plated.

Circuits (n)	Part No.	Dimensions(in/mm)		
		A	B	C
2	FWF25028-S02S24W5M	.098(2.50)	.394(10.00)	.293(7.45)
3	FWF25028-S03S24W5M	.197(5.00)	.492(12.50)	.392(9.95)
4	FWF25028-S04S24W5M	.295(7.50)	.591(15.00)	.490(12.45)
5	FWF25028-S05S24W5M	.394(10.00)	.689(17.50)	.589(14.95)
6	FWF25028-S06S24W5M	.492(12.50)	.787(20.00)	.687(17.45)
7	FWF25028-S07S24W5M	.591(15.00)	.886(22.50)	.785(19.95)
8	FWF25028-S08S24W5M	.689(17.50)	.984(25.00)	.884(22.45)
9	FWF25028-S09S24W5M	.787(20.00)	1.083(27.50)	.982(24.95)
10	FWF25028-S10S24W5M	.886(22.50)	1.181(30.00)	1.081(27.45)
11	FWF25028-S11S24W5M	.984(25.00)	1.024(32.50)	1.179(29.95)
12	FWF25028-S12S24W5M	1.083(27.50)	1.378(35.00)	1.278(32.45)

 THIRD ANGLE PROJECTION	GENERAL TOLERANCES (UNLESS SPECIFIED)		APPROVE BY	DATE	PART NO.	ITEM NO.	 Leader Of Industry
	X.±.012(0.30)	X.±5'	FRANK	01/AUG/13	FWF25028-SXXS24W5M	FWF25028	
DESIGN UNITS Inch (metric)	X.XX±.008(0.20)	.X'±2'	CHECKED BY	DATE	TITLE		REV 0
SCALE	X.XX±.006(0.15)	.XX'±1'	CHERRY	01/AUG/13	Wire to Board (Wafer) Pitch 2.5mm 180° Vertical (SMT)		
5:1	X.XXX±.004(0.10)	.XXX'±0.5'	DRAWN BY	DATE	THIS DRAWING CONTAINS INFORMATION THAT IS PROPRIETARY TO TXGA INDUSTRIAL ELECTRONICS(S.Z)CO.,LTD AND SHOULD NOT BE USED WITHOUT WRITTEN PERMISSION		SHEET NO. 1/2
SIZE			KEVIN	01/AUG/13			
A4							

REV	LOCATIONS	DESCRIPTION	DATE	REVISER	APPD

- Note:
- 10 sprocket hole cumulative tolerance  $\pm 0.2$
  - Carrier camber is within 1.0mm in 100mm
  - Material: White Conductive polystyrene Alloy 100% recyclable
  - All dimensions meet EIA-481-3 requirements
  - Component load per 13" reel: 600 pcs

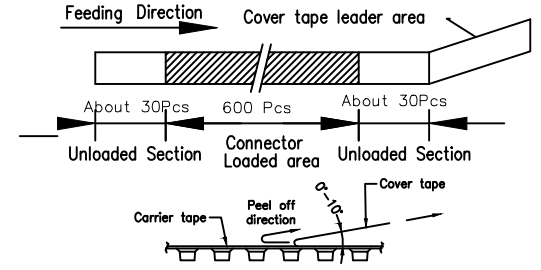
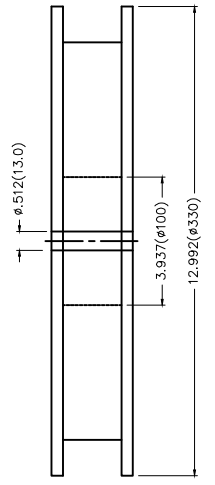
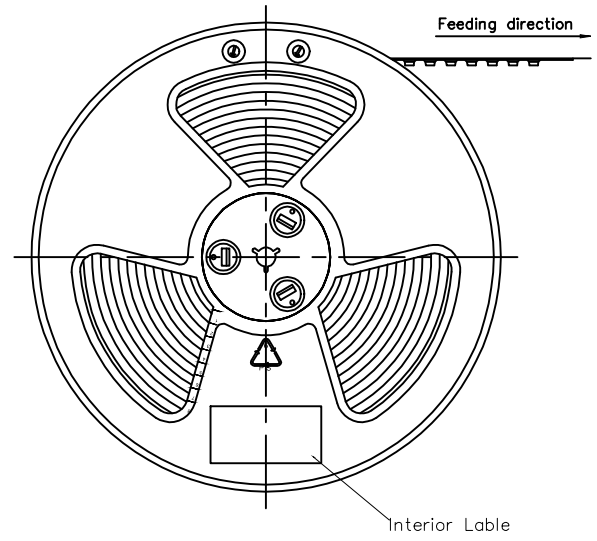

Circuits (n)	Dimensions(in/mm)		Circuits (n)	Dimensions(in/mm)	
	D	W		D	W
2	.295(7.50)	.630(16.00)	8	.559(14.20)	1.260(32.00)
3	.295(7.50)	.630(16.00)	9	.559(14.20)	1.260(32.00)
4	.453(11.50)	.945(24.00)	10	.559(14.20)	1.260(32.00)
5	.453(11.50)	.945(24.00)	11	.795(20.20)	1.732(44.00)
6	.453(11.50)	.945(24.00)	12	.795(20.20)	1.732(44.00)
7	.559(14.20)	1.260(32.00)			

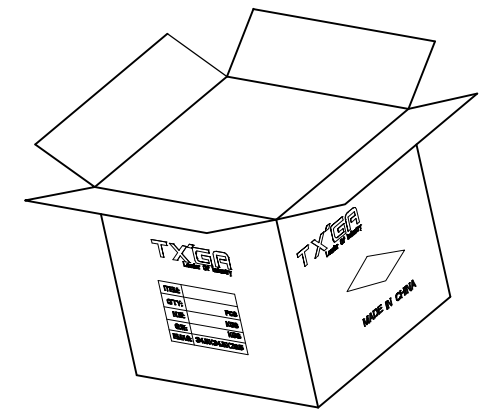
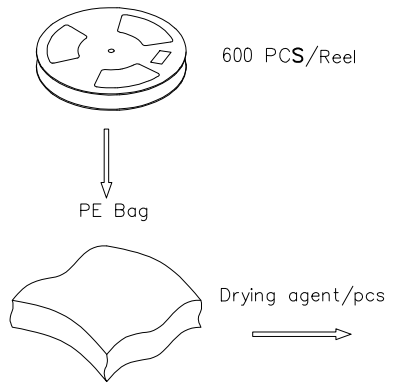
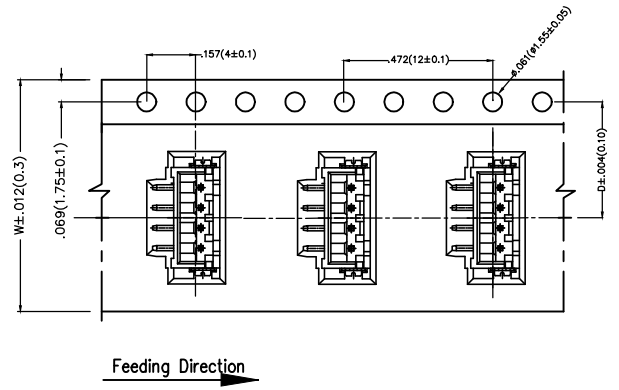

 THIRD ANGLE PROJECTION	GENERAL TOLERANCES (UNLESS SPECIFIED)		APPROVE BY	DATE	PART NO.	ITEM NO.	 Leader Of Industry		
	X.±.012(0.30)	X.±5'	FRANK	01/AUG/13	FWF25028-SXXS24W5M	FWF25028			
	DESIGN UNITS	X.X±.008(0.20)	.X'±2'	CHECKED BY	DATE	TITLE		REV 0	SHEET NO. 3/3
	Inch (metric)	X.XX±.006(0.15)	.XX'±1'	CHERRY	01/AUG/13	Wire to Board (Wafer) Pitch 2.5mm 180° Vertical (SMT)			
SCALE	SIZE	X.XXX±.004(0.10)	.XXX'±0.5'	DRAWN BY	DATE	THIS DRAWING CONTAINS INFORMATION THAT IS PROPRIETARY TO TXGA INDUSTRIAL ELECTRONICS(S.Z)CO.,LTD AND SHOULD NOT BE USED WITHOUT WRITTEN PERMISSION			
5:1	A4			KEVIN	01/AUG/13				

## X-ON Electronics

Largest Supplier of Electrical and Electronic Components

*Click to view similar products for [Headers & Wire Housings](#) category:*

*Click to view products by [TXGA](#) manufacturer:*

Other Similar products are found below :

[0015917161](#) [0022155065](#) [57102-F02-18ULF](#) [58102-G61-06LF](#) [582553-1](#) [01.001.5753.1](#) [0050291907](#) [02.125.8002.8](#) [609-3404](#) [61062-3](#)  
[CSU011177004](#) [622-0430](#) [622-3653LF](#) [63453-116](#) [636-1030](#) [636-1427](#) [636-3427](#) [636-4007](#) [641938-9](#) [65495-038](#) [65692-001LF](#) [65781-018](#)  
[65781-047](#) [65817-010LF](#) [65817-015LF](#) [67095-007LF](#) [67601157](#) [68631-112](#) [68645-018](#) [699319-000](#) [70.362.1628.0](#) [70-4210](#) [70-4226B](#) [70-](#)  
[4853B](#) [71.350.2428.0](#) [733-134](#) [733-162](#) [760-3052](#) [MHR-64-VUAL](#) [80.063.4001.1](#) [800-90-001-10-001000](#) [801-43-002-10-013000](#)  
[801-43-006-10-002000](#) [803-43-024-10-001000](#) [803-93-012-10-001000](#) [8-1437020-4](#) [819-22-004-30-001101](#) [820-22-006-30-001101](#)  
[820-22-008-30-001101](#) [821-22-002-10-001101](#)