

REV	LOCATIONS	DESCRIPTION	DATE	REVISER	APPD
1	△	Change the material and tolerances	13/JUL/20	KATE	CHERRY

Electrical

Current Rating: 5.0A AC(rms)/DC
Voltage Rating: 250V AC(rms)/DC
Contact Resistance: 10 mΩ Max
Insulation Resistance: 1000 MΩ MIN
Withstanding Voltage: 1500V AC r.m.s
Temperature Range—Operating: -40°C ~ +105°C

Material and Plating

△ Housing: PA46(UL 94V-0)
Contact Pin: Brass
Plating: Tin Plated

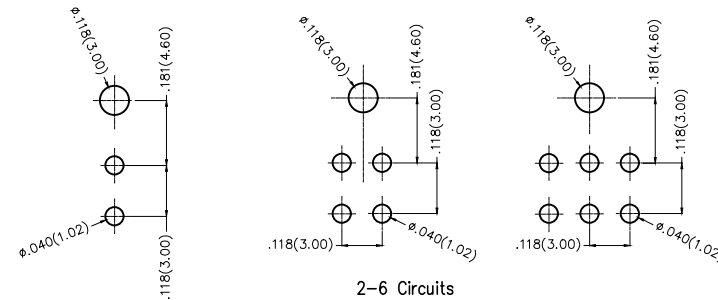
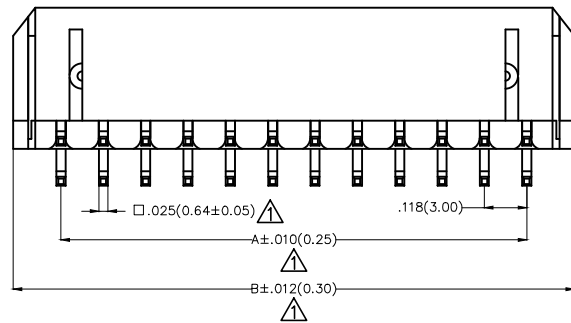
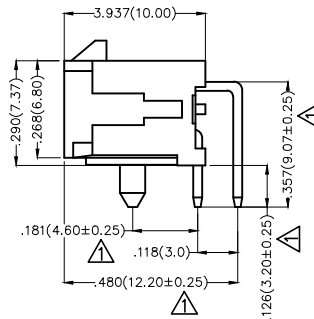
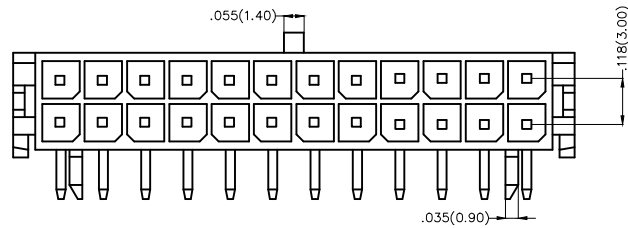

Recommended P.C.Board Layout

Ordering Information

FWF 300 02 — D XX B 2 2 K6 B
1 2 3 4 5 6 7 8 9 10

1 Category FWF—Wafer	2 Series Number 300—Pitch 3.0mm	3 Distinction No. 02	4 Row Option D—Double Row	5 Circuits XX	6 Entry Angle B—90° Angle
7 Plating 2—Tin Plated	8 Material—Resin 2—PA46 △	9 Color—Resin K6—Black	10 Packaging B—PE Bag		

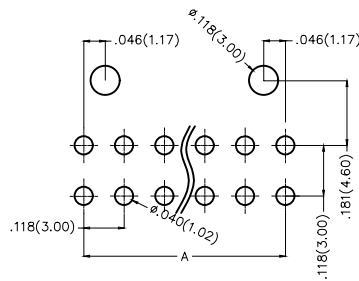

Recommended P.C.Board Layout

THIRD ANGLE PROJECTION	GENERAL TOLERANCES (UNLESS SPECIFIED)		APPROVE BY FRANK	DATE 01/JUL/13	PART NO. FWF30002—DXXB22K6B	ITEM NO. FWF30002	 Leader Of Industry	
	DESIGN UNITS Inch (metric)	X.±.012(0.30) X.X±.008(0.20) X.XX±.006(0.15) X.XXX±.004(0.10)	X'.±5' .X'±2' .XX'±1' .XXX'±0.5'	CHECKED BY CHERRY	DATE 01/JUL/13	TITLE Wire to Board (Wafer) Pitch 3.0mm 90° Angled (DIP)		REV 1
SCALE 5:1	SIZE A4	DRAWN BY JACOB		DATE 01/JUL/13	THIS DRAWING CONTAINS INFORMATION THAT IS PROPRIETARY TO TXGA INDUSTRIAL ELECTRONICS(S.Z)CO.,LTD AND SHOULD NOT BE USED WITHOUT WRITTEN PERMISSION			

1 2 3 4 5 6 7 8

REV	LOCATIONS	DESCRIPTION	DATE	REVISER	APPD

A

A

B

B

C

C

D

D



E

E

F

F

Circuits (n)	Part No.	Dimensions(in/mm)	
		A	B
2	FWF30002-D02B22K6B	—	.264(6.70)
4	FWF30002-D04B22K6B	.118(3.00)	.382(9.70)
6	FWF30002-D06B22K6B	.236(6.00)	.500(12.70)
8	FWF30002-D08B22K6B	.354(9.00)	.618(15.70)
10	FWF30002-D10B22K6B	.472(12.00)	.736(18.70)
12	FWF30002-D12B22K6B	.591(15.00)	.854(21.70)
14	FWF30002-D14B22K6B	.709(18.00)	.969(24.60)
16	FWF30002-D16B22K6B	.827(21.00)	1.091(27.70)
18	FWF30002-D18B22K6B	.945(24.00)	1.209(30.70)
20	FWF30002-D20B22K6B	1.063(27.00)	1.327(33.70)
22	FWF30002-D22B22K6B	1.181(30.00)	1.445(36.70)
24	FWF30002-D24B22K6B	1.299(33.00)	1.563(39.70)

 THIRD ANGLE PROJECTION	GENERAL TOLERANCES (UNLESS SPECIFIED)		APPROVE BY FRANK	DATE 01/JUL/13	PART NO. FWF30002-DXXB22K6B	ITEM NO. FWF30002	 Leader Of Industry	
	DESIGN UNITS Inch (metric)	X.±.012(0.30) X.X±.008(0.20) X.XX±.006(0.15) X.XXX±.004(0.10)	X.±5' .X'±2' .XX'±1' .XXX'±0.5'	CHECKED BY CHERRY	DATE 01/JUL/13	TITLE Wire to Board (Wafer) Pitch 3.0mm 90° Angled (DIP)		REV 1
	SCALE 5:1	SIZE A4	DRAWN BY JACOB	DATE 01/JUL/13	THIS DRAWING CONTAINS INFORMATION THAT IS PROPRIETARY TO TXGA INDUSTRIAL ELECTRONICS(S.Z)CO.,LTD AND SHOULD NOT BE USED WITHOUT WRITTEN PERMISSION			

1 2 3 4 5 6 7 8

X-ON Electronics

Largest Supplier of Electrical and Electronic Components

Click to view similar products for [Headers & Wire Housings](#) category:

Click to view products by [TXGA](#) manufacturer:

Other Similar products are found below :

[0015917161](#) [0022155065](#) [57102-F02-18ULF](#) [58102-G61-06LF](#) [582553-1](#) [01.001.5753.1](#) [0050291907](#) [02.125.8002.8](#) [609-3404](#) [61062-3](#)
[CSU011177004](#) [622-0430](#) [622-3653LF](#) [63453-116](#) [636-1030](#) [636-1427](#) [636-3427](#) [636-4007](#) [641938-9](#) [65495-038](#) [65692-001LF](#) [65781-018](#)
[65781-047](#) [65817-010LF](#) [65817-015LF](#) [67095-007LF](#) [67601157](#) [68631-112](#) [68645-018](#) [699319-000](#) [70.362.1628.0](#) [70-4210](#) [70-4226B](#) [70-](#)
[4853B](#) [71.350.2428.0](#) [733-134](#) [733-162](#) [760-3052](#) [MHR-64-VUAL](#) [80.063.4001.1](#) [800-90-001-10-001000](#) [801-43-002-10-013000](#)
[801-43-006-10-002000](#) [803-43-024-10-001000](#) [803-93-012-10-001000](#) [8-1437020-4](#) [819-22-004-30-001101](#) [820-22-006-30-001101](#)
[820-22-008-30-001101](#) [821-22-002-10-001101](#)