

# 大亞秋田電子科技（深圳）有限公司

碳膜固定電阻器

規格：RD 系列

製造廠商：

大亞秋田電子科技（深圳）  
有限公司

使用廠商：

立創

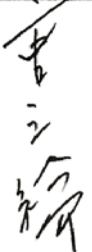
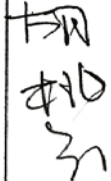
認可	審核	製作
		肖明艷

認可	審核	製作



## 目 錄

## INDEX

序號	內 容	頁 碼
1	適用範圍 Specification	2
2	特性 Feature	2
3	品名 Part Number	2
4	結構圖 Construction	2
5	術語 Glossary	3
6	尺寸 Dimension	4
7	色碼 Explanation of color	4
8	電氣特性 Characteristics	5
9	性能 Performance	5-6
10	成型方式 Forming type	6-8
11	訂貨方式 How To Order	9
12	使用注意事項 Precautions for Use	10

## 1. 適用範圍 Specification

1-1 本承認書僅適用於本公司生產之各種碳膜固定電阻器 (1/8W、1/6W、1/4W、1/2W、1W、2W、3W) 及其小型化之成品規格。

The specification is only suitable for Carbon Film Fixed Resistors(1/8W、1/6W、1/4W、1/2W、1W、2W、3W)and there are small size manufactured by SHI MENG ELECTRONIC CO.,LTD.

1-2 參考標準 Applicable specification

本承認書參考《JIS C5201-2011》和《GB/T 5729-2003/IEC 60115-1:2001》

The specification Applicable specification 《JIS C5201-2011》 and 《GB/T 5729-2003/IEC 60115-1:2001》

1-3 產品符合 RoHS 及 REACH 法規的最新環保要求。

Products meet the latest environmental requirements of RoHS and REACH regulations.

## 2. 特性 Feature

2-1 高品質、低成本 High quality performance、Great economy

2-2 適用自動化插件 Automatically insertable

## 3. 品名 Part Number

依據其種類，分別注明額定功率、容許差、公稱電阻值和形狀。

According to the Resistor type, To mark the Rated power, Tolerance, Resistance value, and forming type.

例(e.g.): RD 1/4W J(±5%) 100Ω T52

種類	額定功率	容許差	阻值	形狀
RD	1/4W	J(±5%)	100Ω	T52

Forming

## 4. 結構圖 Construction

a) 鍍錫銅導線 Tinned copper lead wire (注：可按要求提供 CP 線引腳)

b) 鍍錫鐵帽 Tin-plated steel caps

c) 高穩定性導電膜 High stability Electric conduction film

d) 高熱傳導瓷棒 High heat exchanged ceramic base

e) 環氧樹脂塗料 Epoxy resin coating

f) 色環標示 Color ring Mark

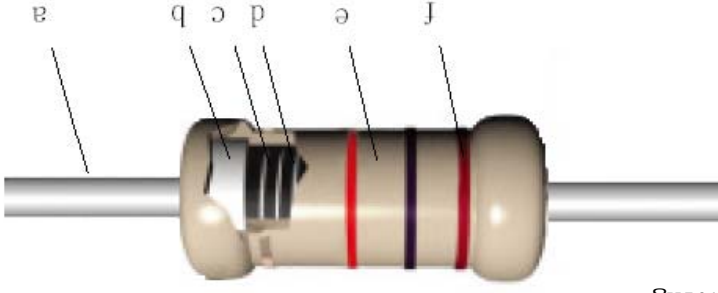

5-1. 標稱阻值：電阻器的設計電阻值，通常標注在電阻器上。

Rated resistance : Designed resistance value usually indicated on the resistor.

5-2. 額定環境溫度：電阻器在額定功率下可持續工作的最高環境溫度。請注意如果電阻器安裝在設備內部，那麼此

處所謂的環境溫度並非設備周圍的溫度，而是設備內部、電阻器周圍的溫度。

Rated Ambient Temperature : Maximum ambient temperature at which the power rating may be applied

continuously. The rated ambient temperature refers to the temperature around the resistor mounted

inside the equipment, not to the air temperature outside the equipment.

5-3. 額定功率：在 70°C 環境溫度下進行耐久性試驗，而且阻值變化不超過該試驗的允許值時所允許的最大功率。

Rated power : At 70 °C ambient temperature durability test, and the change in resistance does not

exceed the value of the test allows the maximum power allowed.

5-4. 降功率曲線：額定功率系適應在周圍溫度 70°C 可以連續負載的最大功率，但額定環境溫度如超過 70°C 時之額定

電力則依圖的降功率曲線實施。

Rated power is maximum power which can be continuously loaded at specified ambient temperature 70

°C, however when Rated Ambient Temperature exceeds 70°C, rated power should be determined from the

derating curve.



5-5. 額定電壓：額定環境溫度或端子部溫度下可連續施加的最大直流電壓或交流電壓（商用頻率實效值），用額定功率和公稱電阻值，按以下公式計算。但額定電壓不可超過最大工作電壓。

Rated Voltage : Maximum allowable D.C. or A.C. voltage(rms), capable to be continuously applied to a resistor or a resistor element under the rated ambient temperature or terminal part temperature.

It shall be calculated from the rated power and nominal resistance using the following formula.

$$U = \sqrt{P \times R} \quad I = \frac{U}{R}$$

U : 電壓  
I : 電流  
P : 功率  
R : 阻值

The rated voltage shall not exceed the max. working voltage.

5-6. 臨界阻值：在不超過最高使用電壓的情況下可施加額定功率的最大公稱電阻值。在臨界電阻值下，額定電壓

等於最大工作電壓。

Critical Resistance : The maximum nominal resistance value at which the rated power can be applied

without exceeding the maximum working voltage. The rated voltage is equal to the max. working voltage at the critical resistance value.

5-7. 最高使用電壓：電阻器或電阻元件上可連續施加的最大直流電壓或交流電壓（商用頻率實效值）。但在臨界電

阻值以下，可以施加的最大電壓為額定電壓。

Maximum Working Voltage : Maximum D.C. or A.C. voltage(rms) that can be continuously applied to the

terminations of a resistor. However, the maximum value of the applicable voltage is the rated voltage at the critical resistance value or lower.

5-8. 過負荷電壓：在短時間過載試驗中可連續施加5秒鐘的電壓，一般為額定電壓的2.5倍，但不可超過最大過載電壓。

Allowable voltage : which is applied in 5 sec. under short time overload test. Overload voltage shall be 2.5 times of rated voltage or max. overload voltage, whichever is lower.

6. 尺寸 Dimension



Unit: mm

Type	Size	L±1	D±1	H±3	d±0.06	Resistance range	Tolerance
±5%	1/6W 1/8W 1/4WS	3.5*	1.7*	27	0.45	0.2Ω & 0.1Ω-15MΩ	±2%
	1/4W 1/2WS	6.5*	2.4*	27	0.50	0.2Ω & 0.1Ω-22MΩ	
	1/2W 1WS	9.2	3.3	26	0.60	0.2Ω & 0.1Ω-22MΩ	
	1W 2WS	11	4.5	28	0.70	0.1Ω-22MΩ	
	2W 3WS	15	5.0	32	0.78	0.1Ω-22MΩ	
	3W 5WS	18	6.0	33	0.78	0.1Ω-22MΩ	

注：①0Ω阻值範圍為<50mΩ；

②“\*” means “±0.5”

③特殊要求如面漆不燃性，色碼耐溶劑清洗等，請訂購時務必向我司提出，可按客戶要求製作。  
④為滿足產品立式使用，引線根部腳漆長度≤1.5mm，臥式使用品不考量此參數；

7. 色碼 Explanation of color



顏色	第一位數	第二位數	倍數	容許差%
Black 黑	0	0	10 <sup>0</sup>	
Brown 棕	1	1	10 <sup>1</sup>	
Red 紅	2	2	10 <sup>2</sup>	G(±2%)
Orange 橙	3	3	10 <sup>3</sup>	
Yellow 黃	4	4	10 <sup>4</sup>	
Green 綠	5	5	10 <sup>5</sup>	
Blue 藍	6	6	10 <sup>6</sup>	
Violet 紫	7	7	10 <sup>7</sup>	
Gray 灰	8	8	10 <sup>8</sup>	
White 白	9	9	10 <sup>9</sup>	J(±5%)
Gold 金			10 <sup>-1</sup>	
Silver 銀			10 <sup>-2</sup>	

注：0Ω用一道黑色表示 Notice: 0Ω mark with one Black color

8. 電氣特性 Characteristics (表一)

Item		Size					
額定功率 Rated power	1/8W 1/6W 1/4WS	1/4W 1/2WS	1/2W 1WS	1W 2WS	1W 2WS	2W 3WS	3W 5WS
最高使用電壓 Max continuous working voltage	200V	250V	350V	500V	500V	500V	500V
最高過負荷電壓 Max overload voltage	400V	500V	700V	700V	700V	1000V	1000V
耐絕緣電壓 Insulation resistance	300V	350V	500V	500V	500V	700V	700V
使用溫度範圍 Operating temp range	-55°C ~ +125°C						

9. 性能 Performance

特性項 Characteristics	規格值 Specifications	測試方法 Test methods
溫度係數 T.C.R	$\leq 10\Omega$ : $\pm 350\text{PPM}/^\circ\text{C}$ ; $11\Omega\sim 99\text{K}\Omega$ : $0\sim -500\text{PPM}/^\circ\text{C}$ ; $100\text{K}\Omega\sim 1\text{M}\Omega$ : $0\sim -800\text{PPM}/^\circ\text{C}$ ; $1.1\text{M}\Omega\sim 10\text{M}\Omega$ : $0\sim -1500\text{PPM}/^\circ\text{C}$ ; $\geq 11\text{M}\Omega$ : $0\sim -2000\text{PPM}/^\circ\text{C}$ ; $+350\text{PPM}/^\circ\text{C}\sim -2000\text{PPM}/^\circ\text{C}$ , 以下阻值段可供參考:	$10^6(\text{PPM})/^\circ\text{C} = \frac{R2-R1}{R1} \times (T2-T1)$ R1: 常溫(T1) 阻抗值. R2: 常溫+100°C(T2) 阻抗值. Resistance value at room temperature (T1). Resistance value at room temperature+100°C.
溫度壽命 Load life	阻抗值變化 $\pm(5\%R+0.05\Omega)$ , 機械特性不可有損傷. Resistance change rate $\pm(5\%R+0.05\Omega)$ MAX. With no evidence of mechanical damage.	溫度 $70\pm 2^\circ\text{C}$ , 恆溫箱中, 加額定電壓或最高使用電壓(取小者), 測試1.5小時停止0.5小時, 連續1000小時. Resistance change after 1000hrs operating at rated voltage or Max continuous working voltage (Whichever is the less.) with duty cycle of 1.5hrs ON 0.5hrs OFF at $70^\circ\text{C}\pm 2^\circ\text{C}$ .
短時間過負荷 Short time over load	$\pm(1\%R+0.05\Omega)$	額定電壓*2.5倍或最高過負荷電壓(取小者), 測試5秒 2.5 times the rated voltage or maximum overload voltage (whichever is less), testing 5 seconds
絕緣阻抗 Insulation resistance	1000M $\Omega$ 以上 1000M $\Omega$ or more	將待測物置於V型槽 V-block

CARBON FILM FIXED RESISTOR

碳膜固定電阻器

<p>耐絕緣電壓 Electric withstanding voltage</p> <p>阻抗值變化 <math>\pm(0.5\%R+0.05\Omega)</math> 塗裝不可燒損, 絕緣不可破壞。 Resistance change <math>\pm(0.5\%R+0.05\Omega)</math>. No evidence of flashover mechanical damage, Arcing or insulation breakdown.</p> <p>電阻兩端導線置於金屬 V 型槽上, 依表一之電壓規定印加 60 秒。 Resistance shall be clamped in the trough of a 90 metallic v-block and shall be test at specified in the above list for 60 seconds.</p>	<p>溫度循環 Temperature cycling</p> <p>阻抗值變化 <math>\pm(1\%R+0.05\Omega)</math> 以內, 機械特性不可有損傷。 Resistance change is <math>\pm(1\%R+0.05\Omega)</math>MAX. With no evidence of mechanical damage.</p> <p>1 -25°C<math>\pm</math>3°C 30 2 Room temp 10-15 3 85°C<math>\pm</math>2°C 30 4 Room temp 10-15</p> <p>將電阻兩端導線浸入錫爐, 浸入深度為距離本體 <math>2^{+0/-0.5}</math>mm; 依下表規定任一項實施</p> <p>Temperature 350°C<math>\pm</math>10°C 260°C<math>\pm</math>5°C</p> <p>Dip time 3<math>\pm</math>0.5 sec 10<math>\pm</math>1 sec</p>	<p>耐熱性 Resistance to soldering heat</p> <p>阻抗值變化 <math>\pm(1\%R+0.05\Omega)</math> 以內, 機械特性不可有損傷。 Resistance change is <math>\pm(1\%R+0.05\Omega)</math>. MAX. With no evidence of mechanical damage.</p>	<p>焊錫性 Solder ability</p> <p>百分之 95 覆蓋於導線上 95% coverage minimum</p>	<p>接頭強度 Join intensity</p> <p>接點不得有脫落情形 No terminal wire loosening and breakage shall occur.</p>	<p>錫爐溫度: 260<math>\pm</math>5°C 浸錫時間: 3<math>\pm</math>0.5 sec Test temperatures of solder: 260<math>\pm</math>5°C Dwell time in solder: 3<math>\pm</math>0.5 sec</p> <p>夾住導線焊接端, 並向外翻轉 90°, 來回兩次。 Bending strength load 90° reciprocation twice</p>
--	---	---	---	--	--

10. 成型方式 Forming type

10-1 Tape packing



STYLE	TYPE	0	L1-L2	P	T	Z	最小包裝數
T-26	1/8W 1/4WS	26 <sup>+1.5</sup> <sub>-0</sub>	1max	5 $\pm$ 0.5	5 $\pm$ 1	5 $\pm$ 1	5000pcs
	1/4W 1/2WS	26 <sup>+1.5</sup> <sub>-0</sub>	1max	5 $\pm$ 0.5	5 $\pm$ 1	5 $\pm$ 1	5000pcs
T-52	1/8W 1/4WS	52 $\pm$ 1	1max	5 $\pm$ 0.2	5 $\pm$ 1	5 $\pm$ 1	5000pcs
	1/4W 1/2WS	52 $\pm$ 1	1max	5 $\pm$ 0.2	5 $\pm$ 1	5 $\pm$ 1	5000pcs
	1/2W 1WS	52 $\pm$ 1	1max	5 $\pm$ 0.2	5 $\pm$ 1	5 $\pm$ 1	2000pcs
T-63	1W 2WS	63 $\pm$ 3	1max	5 $\pm$ 0.5	5 $\pm$ 1	5 $\pm$ 1	1000pcs
	2WS	73 $\pm$ 5	1max	5 $\pm$ 0.5	5 $\pm$ 1	5 $\pm$ 1	1000pcs
T-73	3WS	73 $\pm$ 5	1max	5 $\pm$ 0.5	5 $\pm$ 1	5 $\pm$ 1	1000pcs
	2WS	73 $\pm$ 5	1max	5 $\pm$ 0.5	5 $\pm$ 1	5 $\pm$ 1	1000pcs
	3WS	73 $\pm$ 5	1max	5 $\pm$ 0.5	5 $\pm$ 1	5 $\pm$ 1	5000pcs

10-2 M-Type

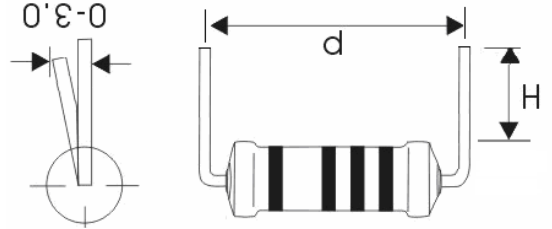

10-3 MK-Type

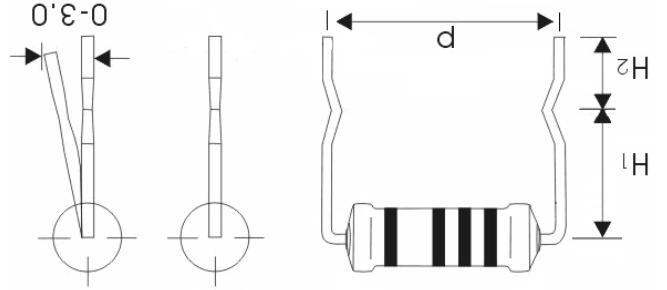

10-4 F-Type

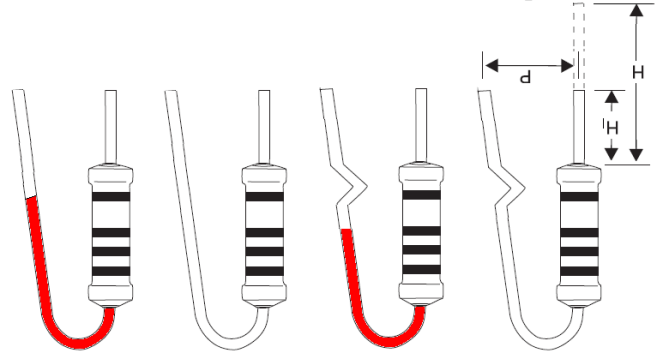

10-5 F-Type 直腳打 KIN (單&雙 KIN)



可依客戶所需求尺寸加工製造

TYPE	P±0.5	H±0.5
1/8W 1/6W 1/4WS	5	3.2~10
1/4W 1/2WS	10	3.2~10
1/2W 1WS	12.5	3.2~10
1W 2WS	15	3.2~10
2W 3WS	20	3.2~10
3W 5WS	25	3.2~10

It can be man fractured according to the dimension that required by customers

TYPE	H1±0.5	H2±1
1/4W 1/2WS	5/8	3.5~6
1/2W 1WS	5/8	3.5~6
1W 2WS	5/8	3.5~6
2W 3WS	5/8	3.5~6
3W 5WS	5/8	3.5~6

注：1/4W 最小腳距為 8mm、1/2W 最小腳距為 12.5mm

1W 最小腳距為 15mm、2W 最小腳距為 20mm

3W 最小腳距為 23mm。

“H” 部份可剪，但長度不得小於 3.2mm

“P” 的尺寸作為參考項，銅質引腳會因加工時的彈性，包裝、儲運、使用等環節的造成彎曲變形，尺寸會有較大誤差。如有爭議，其測

試點以本體以下 3.5±1mm 處為準

TYPE	H1±0.5	H2±1
1/2W 1WS	3.5/6	3.2~10
1W 2WS	3.5/6	3.2~10
2W 3WS	3.5/6	3.2~10
3W 5WS	3.5/6	3.2~10

“H” 部份可剪，但長度不得小於 3.2mm

“P” 的尺寸作為參考項，銅質引腳會因加工時的彈性，包裝、儲運、使用等環節的造成彎曲變形，尺寸會有較大誤差。如有爭議，其測

試點以本體以下 3.5±1mm 處為準



10-6 FT-Avisertv Type 立式編帶 (以下為常規品供參考，可依客戶圖紙要求進行協商加工)

●直腳外彎雙KIN型 (代號 FT-K4)

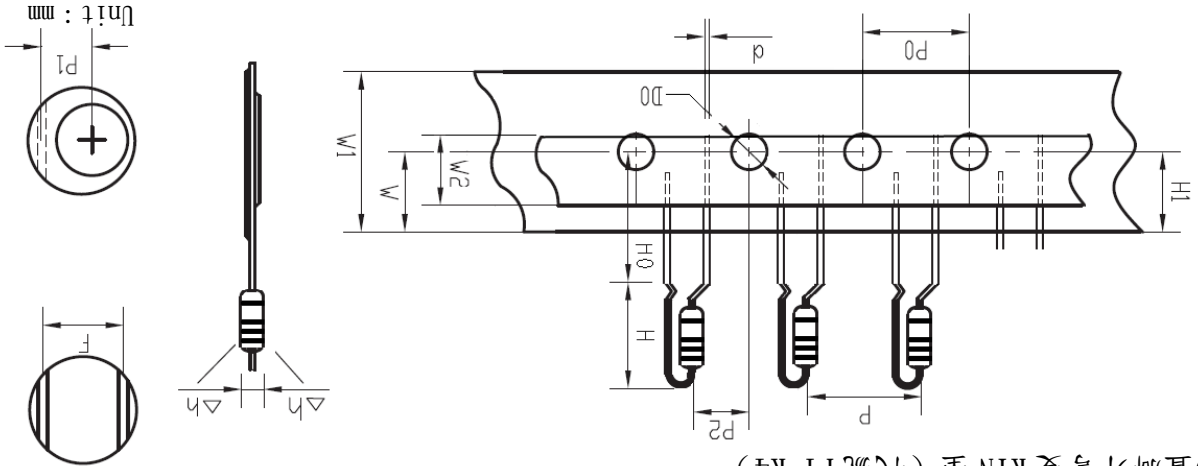

FT-Size	Type	H±1	d	P±1	P0	P1	P2	F±1	Δh	W	W1	W±1	W2	W	W1	W±1	W2	P	P1	P0	d	3WS	2W	1W	1/2W	1/4W	1/2WS	1WS	2WS	3WS			
D0	±0.3	H0	±0.06	P±1	±0.3	±0.7	±1.3	F±1	±0.5	±1	±1	W2	H0	±0.5	±1	±1	±1	±1	±1	±1	±1	11.5	16.5	17.5	15.5	11.5	16.5	17.5	15.5	11.5	16.5	17.5	15.5

Unit : mm

●彎腳打KIN型 (代號 FT-K1)

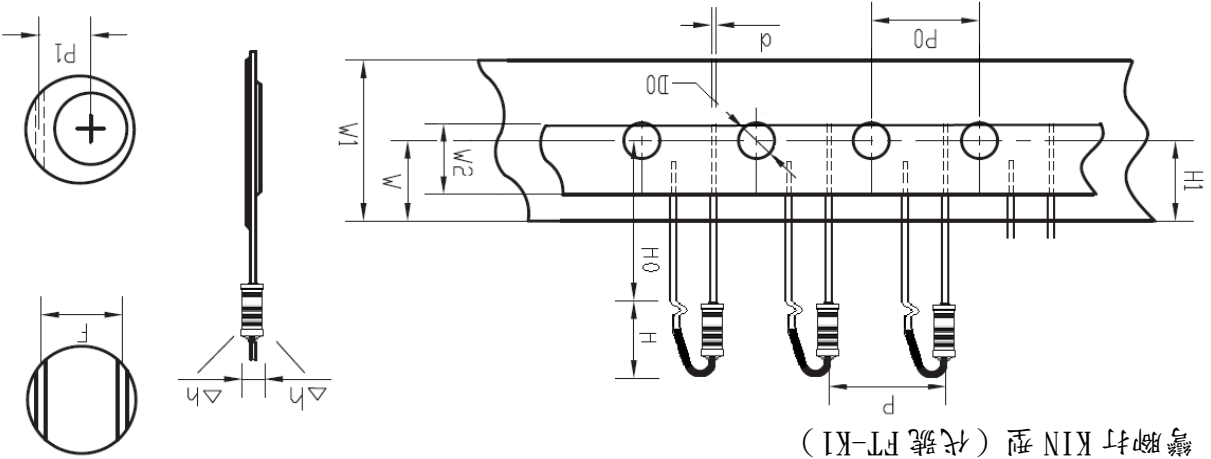

Unit : mm

FT-Size	Type	H±1	d	P±1	P0	P1	P±1	Δh	W	W1	W±1	W2 <th>W</th> <th>W1</th> <th>W±1</th> <th>W2</th> <th>P</th> <th>P1</th> <th>P0</th> <th>d</th> <th>3WS</th> <th>2W</th> <th>1W</th> <th>1/2W</th> <th>1/4W</th> <th>1/2WS</th> <th>1WS</th> <th>2WS</th> <th>3WS</th>	W	W1	W±1	W2	P	P1	P0	d	3WS	2W	1W	1/2W	1/4W	1/2WS	1WS	2WS	3WS										
D0	±0.3	H0	±0.06	P±1	±0.3	±0.7	F±1	±0.5	±1	±1	±1	W2	H0	±0.5	±1	±1	±1	±1	±1	±1	11.5	18	14	11.5	9	18	18	14	18	18	18	18	18	18	18	18	18	18	18

11. 訂貨方式 How To Order

如：碳膜固定電阻器 1/2W T52 ±5% 10Ω  
 Example: CF 1/2W T52 ±5% 10Ω

1 R D 0 0 2 T 5 2 J 0 1 0 0

代碼	1
類別	Product

代碼	Code	瓦特數	Wattage
008	1/8W		
006	1/6W		
004	1/4W		
002	1/2W		
010	1W		
020	2W		
030	3W		
050	5W		

代碼	Code	含義	Meaning
T	Tape / Box		
P	Bulk/ Box		
FT	立式編帶		
Size			
---	Normal size		
s	Small size		
ss	Super small size		
Extent			
26	Tape width 26mm		
52	Tape width 52mm		
63	Tape width 63mm		
73	Tape width 73mm		
尺寸方面不一描述，以此類推			

阻值	Ex.	±2% ±5% 誤差
低阻兩位	0.15Ω	R150
個位Ω	1Ω	0109
十位Ω	10Ω	0100
百位Ω	100Ω	0101
個位K	1K	0102
十位K	10K	0103
百位K	100K	0104
個位M	1M	0105
十位M	10M	0106

代碼	Code	產品類別	Type
RD	碳膜固定電阻器	Carbon film fixed resistors	

代碼	Code	容許差	Tolerance
G	±2%		
J	±5%		

代碼	Code	含義	Meaning

特殊產品預留

## 12. 使用注意事項 Precautions for Use

- 12.1 碳膜電阻的導電層主要成分為碳，阻值越高膜層越薄，當阻值高於幾百 K 歐姆時，膜層厚度可能已經達到納米級，此時產品的可靠性會相對降低，尤其是高濕度的環境下，容易出現偶發性的失效異常。因此，高可靠性要求的產品設計，請勿為了方便而採用超高阻值。
- Carbon film resistor layer of conductive carbon as a main component, the higher resistance film thinner, when high resistance in a few hundred K ohm, film thickness may have reached nanometer level. At this time the reliability of the product will be relatively lower, especially in high humidity environment, prone to occasional abnormal failure. Therefore, the product design of high reliability requirements, do not for convenience using ultra high resistance.

- 12.2 超高阻值部分建議使用我公司的 MG 厚膜玻璃釉電阻（高功率要求適用）或 CHIP 晶片電阻（低功率要求適用），MG 電阻高阻段的耐溫、耐濕、耐壓、耐脈沖、耐腐蝕等方面的可靠性是眾電阻產品之首。
- Ultra high resistance part recommend the use of our MG High voltage surge resistor or chip resistors to replace the precision metal film resistors, Mg resistor of high temperature, humidity, pressure resistance, pulse, corrosion resistance and other aspects of the reliability is the public resistance.

- 12.3 低阻及超低阻的碳膜電阻如線路要求耐電流能力要求高時，請參考我公司的 KN 繞線電阻，其在溫度係數、耐脈沖性能方面有很大的優越性。
- Low resistance and ultra low resistance of the carbon film resistance, such as the line requirements of resistance to high current capacity requirements, please refer to our KN Wire Wound Resistors, which has a great advantage in the temperature coefficient, pulse resistance.

- 12.4 請勿在高阻值碳膜電阻表面使用膠類產品固定或灌封。膠類一方面降低了產品的散熱性能，另一方面整機廠常用的 AB 膠類如酸性未控制好或未完全乾燥的情況下通電使用，會造成電阻導電膜與酸性分子產生電化學反應而出現偶發性的失效，俗稱電阻皮膜被“電蝕”。多年的經驗告訴我們，使用環氧膠類比有機硅膠類出現異常的機率會更大。

Do not use plastic products fixed or potting in the high resistance carbon film resistor surface. Glue on the one hand reduces the radiation performance of the product, on the other hand, the whole plant commonly used AB class such as pH do not control or not completely dry the use of electricity, caused by conductive film and acid and alkali resistance molecular reaction produce electrochemical reaction and occasional failure, commonly known as the electric resistance of coating was electrical erosion. Years of experience tells us that the use of epoxy silicone glue analogy abnormality rate will be greater.

- 12.6 碳膜電阻推出了無腳型產品，可以用 SMT 自動貼片安裝，滿足波峰焊和迴流焊工藝，100%短時間負載測試，可靠性優異。具體請參考我司 MECF-MELF 產品。
- The carbon film resistor is introduced with no foot type products, which can be installed with SMT automatic patch, which can satisfy the process of wave soldering and reflow soldering. The resistance of the non cutting foot type production, does not exist when the cut foot cap appears loose hidden danger, after pickling, electroplating tin and other processes, 100% short time load test, excellent reliability. Specific please refer to our MECF-MELF products.



## X-ON Electronics

Largest Supplier of Electrical and Electronic Components

*Click to view similar products for [Carbon Composition Resistors](#) category:*

*Click to view products by [Tyohm](#) manufacturer:*

Other Similar products are found below :

[IBT1/4102JLF](#) [OE5655](#) [OG5625](#) [OB1025](#) [OE1855](#) [OG2005](#) [IBT1/4100JLF](#) [OF-112JE](#) [OH6205](#) [RC0S2CA270RKE](#) [OF224KE](#)  
[CF18JT910R](#) [RC20GF240J](#) [RC20GF561J](#) [RC07GF361J](#) [RC1/4435JB](#) [RC1/4135JB](#) [RC1/4201JTD](#) [RC1/2331KTD](#) [RC20GF470JTRLF](#)  
[RC1/2155KTD](#) [RC1/4274KTD](#) [RC1/47R5JB](#) [RC1/4565JB](#) [RC1/4160JB](#) [RC1/2475KTB](#) [RC1/2471JTD](#) [RC1/2431JTD](#) [RC1/2334KB](#)  
[RC1/2225KB](#) [RC1/2166KTD](#) [RC1/2103KTD](#) [RC1/2102JTD](#) [RC1/2434JB](#) [RC1/22R4JB](#) [RC1/2165JB](#) [RC07GF510JTR](#) [RCC025 2R7 J B](#)  
[CFR0W4J0242A10](#) [CFR0W4J0391A50](#) [CFR0W4J0303A50](#) [CFR0W4J0433A50](#) [CFR03SJ0753AA0](#) [CFR03SJ0470AA0](#) [CF1/6W-20K±5%](#)  
[T52](#) [CF1/4W-43±5% T52](#) [CFR01SJ0433A10](#) [RD50T5151J](#) [RD 1/8W 33K J T/B A1](#) [RD 2WS 3K6 J T/B A1](#)