



Document No.:S-E17

**TY-OHM ELECTRONIC WORKS CO.,LTD.**

**METAL GLAZE HIGH VOLTAGE RESISTORS  
RESISTOR SPECIFICATION**

**Version : 2019.A**

**APPROVED BY**

<b>APPROVED BY</b>

<b>APPROVED</b>	<b>REVIEWED</b>	<b>PREPARED</b>
<i>Jack Kuo</i> July 18, 2019	<i>Aaron Chen</i> July 19, 2019	<i>Rob Lo</i> July 19, 2019

# METAL GLAZE HIGH VOLTAGE RESISTORS

## 1. Applicable Scope:

This standard specification is for use in consumer electronics, computers, telecommunications, control instruments...etc.

## 2. Part Number:

It is composed by Type, Rated Wattage, Nominal Resistance, Tolerance and Package/Terminal Form. e.g.

RT    1/4W    1M    J    T/B  
Type    Rated Wattage    Nominal Resistance    Tolerance    Package/Terminal Form

### 2.1 Type :

Metal Glaze High Voltage Resistors are called "RT".

### 2.2 Rated Wattage:

Shown by "W", such as 1/4W, 1/2W, 1W, 2W.

### 2.3 Nominal Resistance:

K $\Omega$  , M $\Omega$  are its unit, which be in accordance with JIS-C6409 article 6 (EIA RS-196A) series.

Letter "1M" indicates resistance value 1M $\Omega$ .

### 2.4 Tolerance:

It is measured by Bridge-method at room temperature and expressed by a capital letter.

F= $\pm 1\%$ , J= $\pm 5\%$ .

### 2.5 Package/Terminal Form:

T/R=tape & reel ; T/B=tape in box; Nil= Bulk; MG form; F forms.

T26=26 mm width special tape in box.

T76=76 mm width special tape in box; R76=76 mm width special tape & reel.

Remark : RT Series Resistors are RoHS & Halogen Free Compliant.

## 3. Rated Power:

Rated power is the value of Max load wattage specified at the ambient temperature of 70 $^{\circ}\text{C}$ , and shall meet the functions of electrical and mechanical performance. When the ambient temperature surpasses above mentioned temperature, the value declines as per following DERATING CURVE.

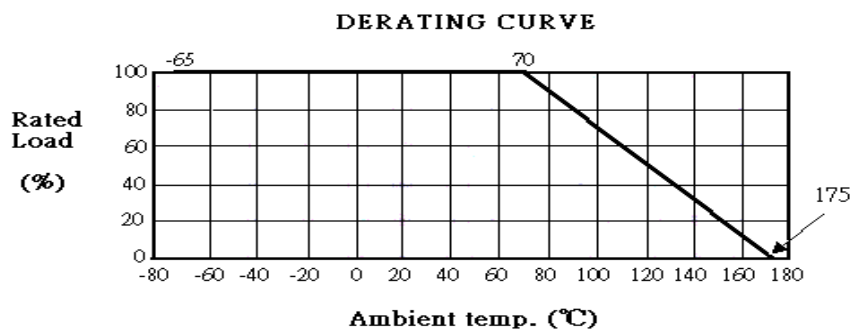

# METAL GLAZE HIGH VOLTAGE RESISTORS

## 3.1 Rated Voltage:

It is calculated through the following formula:

$$E = \sqrt{P * R}$$

where E: rated voltage (V)

P: rated power (W)

R: nominal resistance value ( $\Omega$ )

However, in case the voltage calculated exceeds the maximum load voltage, such the maximum load voltage shall be regarded as its rated voltage, means whichever less.

## 4. Dimension and structure:

### 4.1 Dimension:

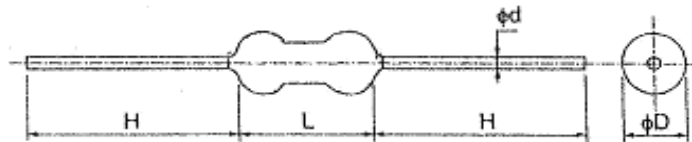

Unit: mm

TYPE	D $\pm$ 1	L $\pm$ 1	H $\pm$ 3	d $\pm$ 0.1	Resistance Range	Max, Permissible Voltage	
						DC	RMS
RT 1/4W	2.4 $\pm$ 0.5	6.4	28	0.6	47K $\Omega$ ~ 33M $\Omega$	1600V	1150V
RT 1/2W	3.5	9	28	0.65	47K $\Omega$ ~ 33M $\Omega$	3500V	2500V
RT 1W	4.5	11	28	0.8	47K $\Omega$ ~ 33M $\Omega$	5000V	3500V
RT 2W	5	15	28	0.8	47K $\Omega$ ~ 33M $\Omega$	10000V	7000V

© Note: 1. Too low or too high ohmic values can be supplied only case by case.

2. RT 1W & RT 2W are coated by flameproof paint.

3. UL 1676 approval : RT 1/2W, RT 1W, RT 2W series (960K $\Omega$  ~12M $\Omega$ )

### 4.2 Structure:

#### 4.2.1 Ceramic Rod:

It is made of Forsterite imported.

#### 4.2.2 Terminal:

Terminal is to be firmly connected with resistors element, both electrically and mechanically, and allow easy soldering.

#### 4.2.3 Coating:

Coating is done by light blue flameproof paint for 1W, 2W type and light green epoxy paint for 1/4W, 1/2W type which is solid enough to be free from looseness, crack and easy breakage. It is also resistant to cleaning and industrial solvents, and the paint shall be limited within 2mm of lead wires from resistor body.

# METAL GLAZE HIGH VOLTAGE RESISTORS

---

## 4.2.4 Marking:

Marking is made on resistors surface, by color coding.

## 5. Operating Temperature Range: -65°C ~ 175°C

## 6. Mechanical Performance:

### 6.1 Terminal tensile:

To fix the resistor body, a static load of 2.5kg.(under 1/2W:1kg.) is to be gradually applied into the terminal for 10 seconds without causing any looseness and fall.

### 6.2 Twist withstand:

To bend the lead wire at the point of about 6mm from resistor body to 90°, then catch the wire at 1.2 ±0.4mm apart from the bent point end and turn it (clockwise) by 360 degrees perpendicular to the resistor axis at speed of 5 seconds per turn, and do the same counterclockwise again which constitute a whole turn. Repeat the turn 2 times without causing any break and looseness.

## 7. Electrical Performance:

### 7.1 Resistance Temperature Coefficient:

It shall be within ±200ppm/°C.

$$T.C \text{ (ppm/°C)} = \left[ \frac{R_2 - R_1}{R_1} \right] \times \left[ \frac{1}{T_2 - T_1} \right] \times 10^6$$

where

R1: resistance value at reference temperature

R2: resistance value at test temp.

T1: reference temp.

T2: test temp.

### 7.2 Temperature Cycle:

Following temp. cycles are to be made 5 times and then put at room temp. for one hour, the resistance value change rate between pre-and-post test shall be within ±0.5%.

Steps	Temperature(°C)	Time (minutes)
1 <sup>st</sup> step	-65 ± 3	30
2 <sup>nd</sup> step	Room temp.	3
3 <sup>rd</sup> step	175 ± 3	30
4 <sup>th</sup> step	Room temp.	3

### 7.3 Short Time Over Load:

When the resistors are applied 2.5 times as much as rated voltage for 5 seconds continuously, it shows no evidence of arc, flame...etc. Removing the voltage and place the resistors to the normal condition for 30 minutes, the resistance value change rate between pre-and-post test shall be within ±1% .

# METAL GLAZE HIGH VOLTAGE RESISTORS

---

## 7.4 Insulation Character :

Resistors are located in a V-shaped metal trough. Using the DC 100V megger instrument 2 poles to clutch either side of lead wires and metal trough, measuring the Insulation Resistance which shall be over 1000M $\Omega$  .

## 7.5 Voltage Withstanding:

Resistors are located in a V-shaped metal trough. Applying AC 350V for one minute and should find no physical damage to the resistors, such as arc, char ...etc.

## 7.6 Load Life:

The resistors arrayed are sent into the 70 $^{\circ}\text{C}$  oven, applying rated voltage at the cycle of 1.5 hours ON, 0.5 hour OFF for 1000 $_{-0}^{+48}$  hours in total. Then, after removing the voltage, take the resistors out of the oven and left under normal temp. for one hour cooling. The resistance value change rate between pre-and-post test shall be within  $\pm 3\%$ .

## 7.7 Moisture-proof Load Life:

The resistors arrayed are placed into a constant temp./humidity oven at the temp. of 40 $\pm 2^{\circ}\text{C}$  and the humidity of 90~95%, then rated power is applied for 1.5 hours and cut off for 0.5 hour. The similar cycle will be repeated for 500 $_{-0}^{+24}$  hours in total (including cut-off time). Then remove the voltage, taking the resistors out of the oven and leaving them at room temp. for one hour. The resistance value change rate between pre-and-post test shall be within  $\pm 3\%$ . There also shall be no evidence of remarkable change on appearance, and the marking shall not be illegible.

## 7.8 Solder-ability:

The leads with flux are dipped in a melted solder of 235  $\pm 5^{\circ}\text{C}$  for 2 seconds, more than 95% of the circumference of the lead wires shall be covered with solder.

## 7.9 Resistance to Soldering Heat:

Two leads are together dipped in a melted solder of 270  $\pm 5^{\circ}\text{C}$  for 10  $\pm 1$  seconds, or 350  $\pm 10^{\circ}\text{C}$  for 3.5  $\pm 0.5$  seconds, Then remove the resistors and leaving them at room temp. for one hour. The resistance value change rate between pre-and-post test shall be within  $\pm 1\%$ .

## 7.10 Nonflammability (only for 1W, 2W):

The resistors are applied the power of 16 times the rated wattage for 5 min. and shall not get flame.

# METAL GLAZE HIGH VOLTAGE RESISTORS

## 7.11 Pulse Loading Capability:

In accordance with IEC 60065 chapter 14.2a; 50 discharges from a 1 nF capacitor charged to  $V_{max}$ ; 12 discharges/minute (drift  $\Delta R/R \leq 2\%$ )

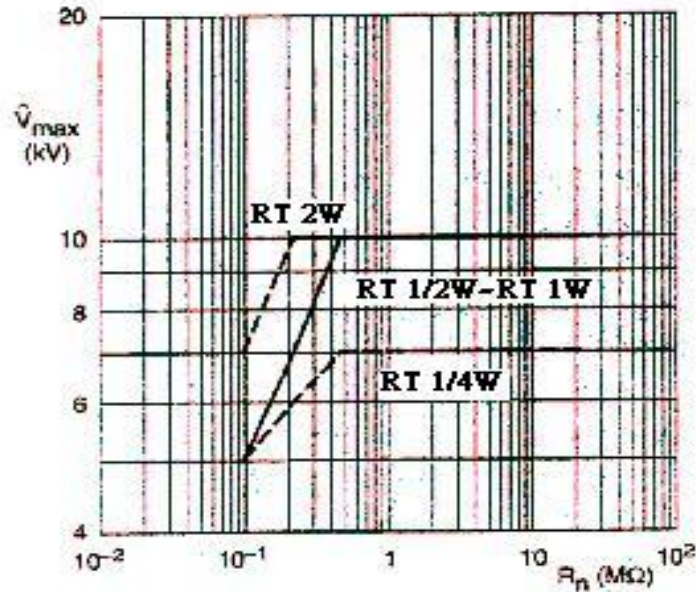

## 8. Others:

### 8.1 MG Form:

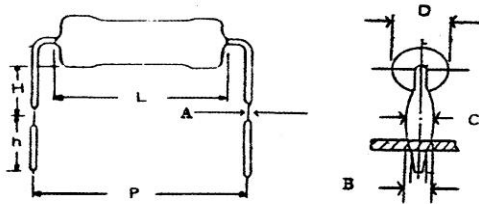

Unit: mm

RT	$D \pm 1$	$L \pm 1$	P	H	$h \pm 1$	$A \pm 0.1$	$B \pm 0.05$	$C \pm 0.2$
1/2W	3.5	9	$15 \pm 1.5$	$7 \pm 1$	4.5	0.23	0.8	1.2
1W	4.5	11	$15 \pm 1.5$	$7 \pm 1$	4.5	0.25	1	1.4
2W	5	15	$20 \pm 2$	$10 \pm 2$	4.5	0.25	1	1.4

# METAL GLAZE HIGH VOLTAGE RESISTORS

## 8.2 F Form:

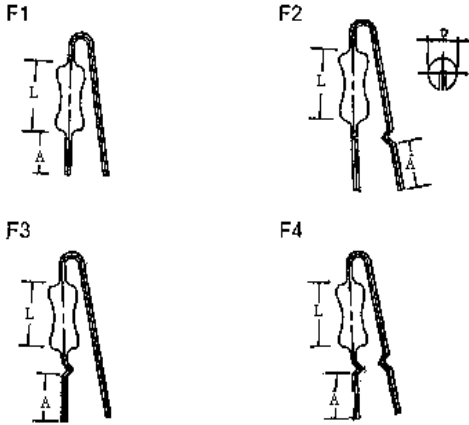

Unit: mm

RT	D $\pm$ 1	L $\pm$ 1	A +1/-0.5	Applicable
1/2W	3.5	9	3.5	F1~F4
1W	4.5	11	3.5	F1~F4
2W	5	15	3.5	F1~F4

## 8.3 Packing:

### 8.3.1 Taping Specifications :

Unit: mm

RT	Size	A	B	C $\pm$ 1	D Max	E Max
	Package					
1/4W	T26	26 <sup>+1</sup> <sub>-0</sub>	5 $\pm$ 0.5	6	0.6	1.2
	T/B	52 $\pm$ 1	5 $\pm$ 0.5	6	0.6	1.2
1/2W	T/B	52 $\pm$ 1	5 $\pm$ 0.5	6	0.6	1.2
1W	T/B	63 $\pm$ 1	5 $\pm$ 0.5	6	0.6	1.2
2W	T/B	63 $\pm$ 1	10 $\pm$ 1	6	0.6	1.2
	T76, R76	76 $\pm$ 1.5	10 $\pm$ 1	6	0.6	1.2

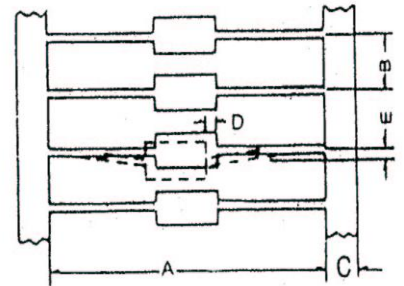

# METAL GLAZE HIGH VOLTAGE RESISTORS

## 8.3.2 Tape in Box:

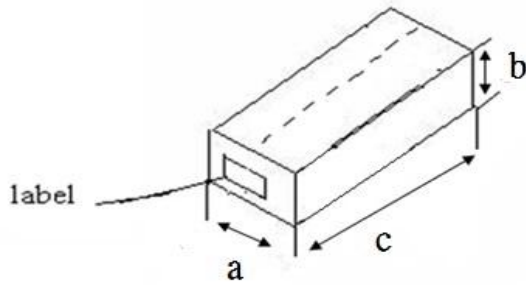

Unit: mm

RT	Package	QTY PER BOX	a	b	c
1/4W	T26	4,000	50	90	255
	T/B	5,000	75	100	255
1/2W	T/B	1,000	75	55	255
1W	T/B	1,000	85	105	260
2W	T/B	1,000	85	105	260
	T76	1,000	106	110	265

## 8.3.3 Tape & Reel:

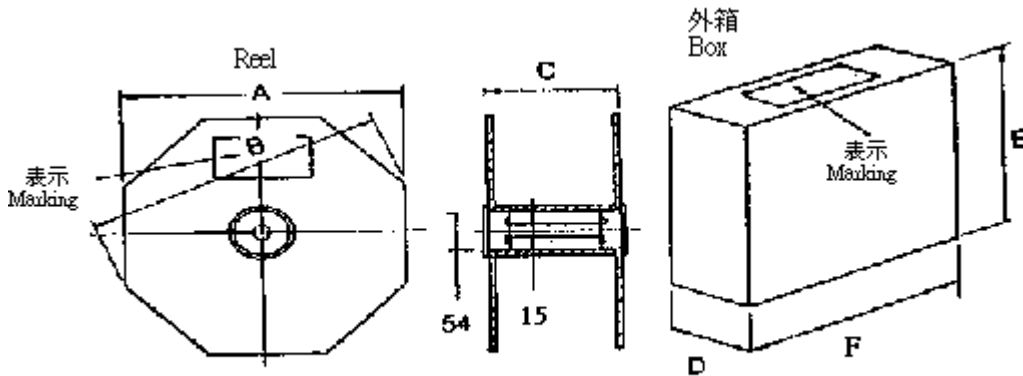

Unit: mm

RT	Package	QTY PER REEL	A	B	C	D	E	F
1/4W	T/R	5,000	285	310	75	80	295	295
1/2W	T/R	5,000	305	330	75	90	310	310
1W	T/R	2,000	285	310	75	80	295	295
2W	T/R	1,000	285	310	75	80	295	295
	R76	1,000	285	310	90	105	295	295



## X-ON Electronics

Largest Supplier of Electrical and Electronic Components

*Click to view similar products for [Thick Film Resistors - Through Hole](#) category:*

*Click to view products by [Tyohm](#) manufacturer:*

Other Similar products are found below :

[M8340104K3300GCD03](#) [M8340105K3300GGD03](#) [M8340105K3922FGD03](#) [M8340107K2401GCD03](#) [M8340109K1002JCD03](#)

[M8340109K1003GCD03](#) [MP850-3.00-1%](#) [ARC3.11 2M J A](#) [M8340105K1003GCD03](#) [M8340105M2201GCD03](#) [M8340107M7501GCD03](#)

[M8340108K2051FCD03](#) [M8340108K7501GCD03](#) [M8340108M5100JGD03](#) [M8340109K1000GCD03](#) [MOX-GRD-001](#)

[M8340102M4701GBD04](#) [M8340102K1002GBD04](#) [M8340109K2002GGD03](#) [M8340108K2002FGD03](#) [OE1305](#) [MS-221-82R5](#) [MOX-](#)

[750231004DE](#) [MOX-4-127505J](#) [SM102034504FE](#) [MOX300002206FE](#) [MOX-400233004F](#) [MOX300001005BE](#) [SM104066008J](#) [MOX-](#)

[400262008PE](#) [MOX-400232506FE](#) [MOX-400234007FE](#) [MOX-400221006G](#) [MOX-750235006ME](#) [SM103032506FE](#) [SM202022005FE](#)

[MOX1125231002FE](#) [MOX-1-122504F](#) [MOX-400225003F](#) [MOX1125731008FE](#) [MOX-5-126002JE](#) [MS176-2.20M-1%](#) [MOX-830212453BE](#)

[TRHE01A270RJ2E](#) [TRHE01A560RJ2E](#) [TRHP01A200RF2E](#) [TRHP01A5001F2E](#) [MG715-2.40M-1%](#) [MS214-20.0K-1%](#) [MF0W4FF4702A50](#)