

# BMD-341

## Stand-alone Bluetooth 5 low energy and IEEE 802.15.4 module

Data sheet



### Abstract

This technical data sheet describes the BMD-341 stand-alone Bluetooth® low energy and IEEE 802.15.4 module. The OEMs can embed their own application on top of the integrated Bluetooth low energy stack using Nordic Semiconductor SDK integrated development environment (IDE).

# Document information

<b>Title</b>	<b>BMD-341</b>	
<b>Subtitle</b>	Stand-alone Bluetooth 5 low energy and IEEE 802.15.4 module	
<b>Document type</b>	Data sheet	
<b>Document number</b>	UBX-19033643	
<b>Revision and date</b>	R07	2-Feb-2021
<b>Disclosure restriction</b>	C1-Public	

<b>Product status</b>	<b>Corresponding content status</b>	
<b>Functional sample</b>	Draft	For functional testing. Revised and supplementary data will be published later.
<b>In development / Prototype</b>	Objective specification	Target values. Revised and supplementary data will be published later.
<b>Engineering sample</b>	Advance information	Data based on early testing. Revised and supplementary data will be published later.
<b>Initial production</b>	Early production information	Data from product verification. Revised and supplementary data may be published later.
<b>Mass production / End of life</b>	Production information	Document contains the final product specification.

This document applies to the following products:

<b>Product name</b>	<b>Type number</b>	<b>Firmware version</b>	<b>IN/PCN reference</b>	<b>Product status</b>
BMD-341	BMD-341-A-R-00	N/A	N/A	Initial production
BMD-341	BMD-341-A-R-10	N/A	UBX-20009068	Initial production

u-blox or third parties may hold intellectual property rights in the products, names, logos and designs included in this document. Copying, reproduction, modification or disclosure to third parties of this document or any part thereof is only permitted with the express written permission of u-blox.

The information contained herein is provided "as is" and u-blox assumes no liability for its use. No warranty, either express or implied, is given, including but not limited to, with respect to the accuracy, correctness, reliability and fitness for a particular purpose of the information. This document may be revised by u-blox at any time without notice. For the most recent documents, visit [www.u-blox.com](http://www.u-blox.com).

Copyright © u-blox AG.

# Contents

<b>Document information .....</b>	<b>2</b>
<b>Contents .....</b>	<b>3</b>
<b>1 Functional description.....</b>	<b>5</b>
1.1 Features .....	5
1.2 Applications .....	6
1.3 Block diagram .....	6
1.4 Product specifications .....	7
<b>2 Pin definition.....</b>	<b>9</b>
2.1 Pin assignment.....	9
2.2 Peripheral pins .....	11
2.3 BMD-300 series footprint compatibility and migration.....	12
2.3.1 BMD-300/301/330/360 to BMD-341 pad differences .....	13
2.3.2 BMD-300/301/330/360 to BMD-341 design migration .....	13
2.4 BMD-341 fan-out example.....	14
<b>3 Electrical specifications.....</b>	<b>15</b>
3.1 Absolute maximum ratings .....	15
3.2 Operating conditions.....	15
3.3 Power and DCDC configuration.....	16
3.3.1 USB power .....	16
3.3.2 Normal (LV) power mode examples .....	17
3.3.3 High voltage (HV) power mode examples .....	18
3.4 General purpose I/O .....	19
3.5 Module reset .....	19
3.6 Debug and programming.....	19
3.7 Clocks .....	20
3.7.1 32.768 kHz crystal (LFXO).....	20
3.7.2 32.768 kHz clock source comparison.....	20
<b>4 Firmware.....</b>	<b>21</b>
4.1 Factory image .....	21
4.2 SoftDevices .....	21
4.2.1 S140 .....	21
4.2.2 S340 .....	21
4.2.3 IEEE 802.15.4 (Thread and Zigbee).....	22
4.3 Bluetooth device address .....	22
<b>5 Mechanical specifications.....</b>	<b>23</b>
5.1 Dimensions.....	23
5.2 Recommended PCB land pads .....	23
5.3 Module marking.....	24
5.3.1 Module marking for type number BMD-341-A-R-00.....	24
5.3.2 Module marking for type number BMD-341-A-R-10.....	25

<b>6</b>	<b>RF design notes</b>	<b>26</b>
6.1	Recommended RF layout and ground plane	26
6.2	Mechanical enclosure	26
6.3	Approved external antennas	26
6.3.1	Canada (ISED) Antenna Statement	26
6.3.2	Antenna List	26
<b>7</b>	<b>BMD-341 evaluation development kit</b>	<b>27</b>
<b>8</b>	<b>Qualification and approvals</b>	<b>28</b>
8.1	United States (FCC)	28
8.1.1	Labeling and user information requirements	28
8.1.2	RF exposure	28
8.2	Canada (ISED)	29
8.2.1	Labeling and user information requirements	29
8.2.2	RF exposure	29
8.3	European Union regulatory compliance	30
8.3.1	Radio Equipment Directive (RED) 2014/53/EU	30
8.3.2	Labeling and user information requirements	30
8.4	Australia / New Zealand (RCM)	30
8.5	Bluetooth qualification	30
<b>9</b>	<b>Environmental</b>	<b>31</b>
9.1	RoHS	31
9.2	REACH	31
9.3	California proposition 65 (P65)	31
<b>10</b>	<b>Product handling</b>	<b>32</b>
10.1	Packaging	32
10.1.1	Reel packaging for type number BMD-341-A-R-00	32
10.1.2	Reel packaging for type number BMD-341-A-R-10	32
10.1.3	Carrier tape dimensions for type number BMD-341-A-R-00	32
10.1.4	Carrier tape dimensions for type number BMD-341-A-R-10	33
10.2	Moisture sensitivity level	34
10.3	Reflow soldering	34
10.4	ESD precautions	34
<b>11</b>	<b>Ordering information</b>	<b>35</b>
<b>12</b>	<b>Life support and other high-risk use warnings</b>	<b>36</b>
	<b>Related documents</b>	<b>37</b>
	<b>Revision history</b>	<b>37</b>
	<b>Contact</b>	<b>38</b>

# 1 Functional description

The BMD-341 is an advanced, highly flexible, ultra-low power multiprotocol System on Module (SoM) that enables Bluetooth 5 (Bluetooth low energy) and IEEE 802.15.4 (Thread and Zigbee) connectivity for portable, extremely low power embedded systems. With an Arm® Cortex®-M4 with FPU processor, integrated 2.4 GHz transceiver, and a U.FL connector for an external antenna, the BMD-341 provides a complete RF solution allowing faster time to market with reduced development costs. Providing full use of the Nordic Semiconductor nRF52840 capabilities and peripherals, the BMD-341 can power the most demanding applications, all while simplifying designs and reducing BOM costs. The BMD-341 is an ideal solution for designs that require Bluetooth 5 features or 802.15.4 based networking for Thread and Zigbee. Increased integration with built in USB and 5.5V compatible DC/DC supply reduces design complexity and BOM cost, while expanding possible applications. BMD-341 designs are footprint compatible with the BMD-300/301/330/340/360, providing low-cost flexibility for tiered product lineups.

## 1.1 Features

- Based on the Nordic Semiconductor nRF52840 SoC
- Bluetooth 5 PHYs: LE 1M, LE 2M, and LE Coded (long range)
- Bluetooth 5 features: Advertising Extensions, Channel Selection Algorithm #2
- Bluetooth mesh
- IEEE 802.15.4 with Thread and Zigbee support
- Complete RF solution with U.FL connector for an external antenna
- Integrated DC-DC converter
- No external components required
- Arm® Cortex®-M4 with FPU 32-bit processor
- Arm® TrustZone® Cryptocell 310 security
- 128-bit AES HW encryption
- True random number generator
- Serial Wire Debug (SWD)
- Nordic Semiconductor SoftDevice ready
- 1 MB embedded flash memory
- 256 kB RAM
- 48 General Purpose I/O Pins
- 12-bit/200 KSPS ADC
- One Full-Speed USB peripheral (12 Mbps)
- Four SPI Master/Slave (8 Mbps)
- Quad SPI with Execute in Place (XIP)
- PWM 4 blocks x 4-channels each
- General Purpose and low-power comparators
- Temperature sensor
- Two 2-wire master/slave (I2C compatible)
- I2S audio interface
- Two UARTs (w/ CTS/RTS and DMA)
- 20-channel CPU independent Programmable Peripheral Interconnect (PPI)
- Quadrature Demodulator (QDEC)
- 5 x 32 bit timer/counters
- 3 x 24 bit Real Timer Counters (RTC)
- NFC-A tag interface for OOB pairing
- Dimensions: 15.0 x 10.2 x 1.9 mm

## 1.2 Applications

- Climate control
- Lighting products
- Safety and security
- Home appliances
- Access control
- Internet of Things
- Home health care
- Advanced remote controls
- Smart energy management
- Low-power sensor networks
- Interactive entertainment devices
- Environmental monitoring
- Hotel automation
- Office automation

## 1.3 Block diagram

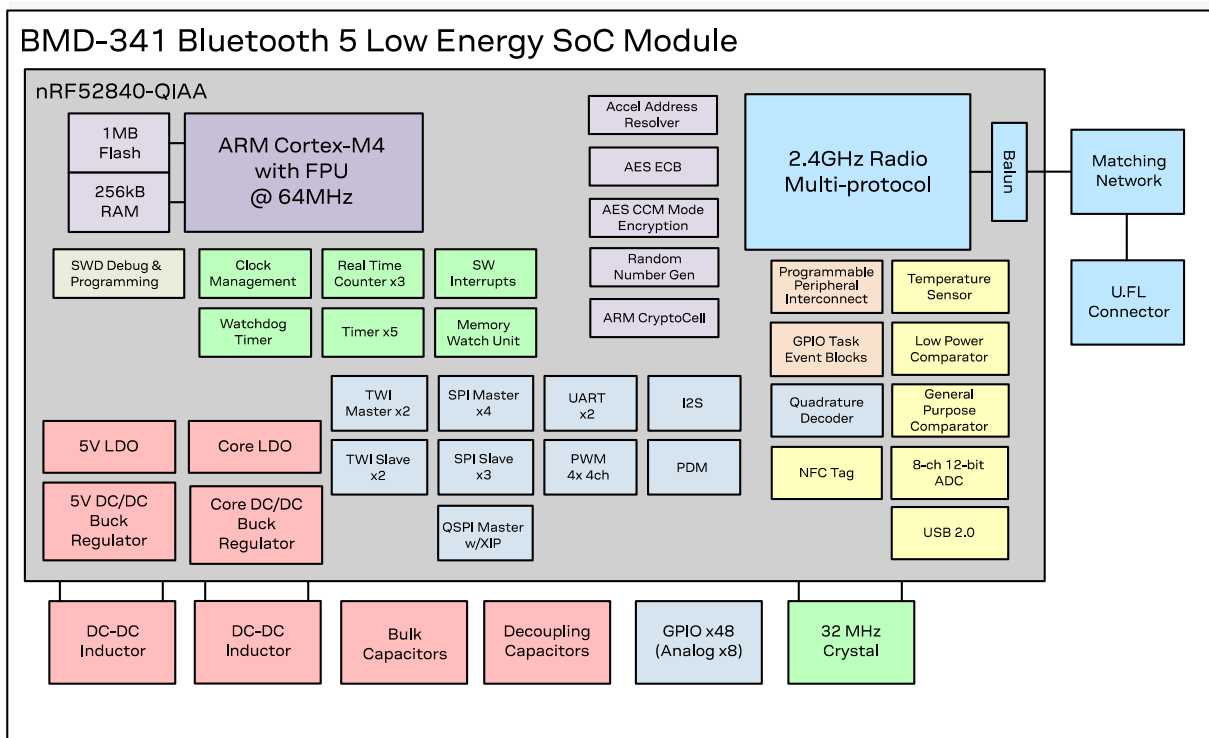

Figure 1: Block diagram of BMD-341

## 1.4 Product specifications

Detail	Description
<b>Bluetooth</b>	
Bluetooth version	Bluetooth 5 Low Energy, Concurrent Central & Peripheral (S140), LE Coded PHY (Long Range), LE 2M PHY, LE 1M PHY, Advertising Extensions, CSA #2, Bluetooth mesh
Bluetooth security	AES-128, Arm® Cryptocell accelerated
LE connections	Concurrent central, observer, peripheral, and broadcaster roles with up to twenty concurrent connections along with one Observer and one Broadcaster (S140)
<b>IEEE 802.15.4</b>	
Thread stack	OpenThread, Thread 1.1
Thread security	AES-128, Arm® Cryptocell accelerated
Zigbee stack	Zigbee Compliant Platform
<b>Radio</b>	
Frequency	2.360 GHz to 2.500 GHz
Modulations	GFSK at 1 Mbps and 2 Mbps, QPSK at 250 kbps
Transmit power (EIRP with maximum gain antenna)	+11 dBm maximum
Receiver sensitivity	-96 dBm (Bluetooth low energy mode, LE 1M PHY)
Antenna	External through U.FL connector
<b>Current consumption</b>	
TX only @ +8 dBm, 0 dBm @ 3V, DCDC enabled	14.8 mA, 4.8 mA
TX only @ +8 dBm, 0 dBm	32.7 mA, 10.6 mA
RX only @ 1 Mbps @ 3V, DCDC enabled	4.6 mA
RX only @ 1 Mbps	9.9 mA
CPU @ 64 MHz from flash, from RAM	6.3 mA, 5.2 mA
CPU @ 64 MHz from flash, from RAM @ 3V, DCDC enabled	3.3 mA, 2.8 mA
System Off, On (Supply on VCC), no RAM retention	0.4 µA, 0.97 µA
System Off, On (Supply on VCC), full 256 KB RAM retention	1.86 µA, 2.35 µA
<b>Dimensions</b>	
BMD-341	Length: 15.0 mm ± 0.3 mm
	Width: 10.2 mm ± 0.3 mm
	Height: 1.9 mm ± 0.1 mm
<b>Hardware</b>	
Interfaces	SPI Master/Slave x 4 Quad SPI x 1 UART x 2 Two-Wire Master/Slave (I2C) x 2 GPIO x 48 I2S x1 PWM x 16 (4 blocks x 4-channels each) PDM x 1 USB 2.0 x 1 Analog input x 8
Power supply	VCC: 1.7 V to 3.6 V, 1.75 V required to start DCDC VCCH: 2.5 V to 5.5 V VBUS: 4.35 V to 5.5 V (For USB operation)
Temperature range	-40 °C to +85 °C

Detail	Description
<b>Certifications</b>	
USA (FCC)	FCC part 15.247 modular certification FCC ID: XPYBMD341
Canada (ISED)	Innovation, Science and Economic Development Canada RSS-247 modular certification IC: 8595A-BMD341
Europe (CE)	EN 60950-1: A2:2013 3.1 (a): Health and Safety of the User EN 301 489-1 V2.1.1 & 3.1 (b): Electromagnetic Compatibility EN 301 489-17 V3.1.1 EN 300 328 V2.1.1 3.2: Effective use of spectrum allocated
Australia / New Zealand (RCM)	AS/NZS 4268:2017, Radio equipment and systems – Short range devices
Bluetooth	BMD-341 RF-PHY Component (Tested) – DID: D040773; QDID: 95452
<b>Radio chip</b>	
Nordic Semiconductor nRF52840	Additional details: <a href="#">nRF52840 Product Specification</a> <a href="#">Software Development Kit</a>

**Table 1: Product specifications**



## 2 Pin definition

### 2.1 Pin assignment

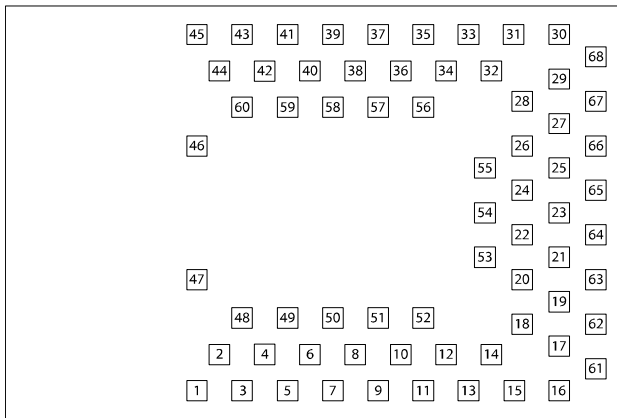

Figure 2: BMD-341 Pin assignment (Top view)

No.	Name	I/O	Description	nRF52 pin	Remarks
1	GND	Power	Electrical Ground		
2	GND	Power	Electrical Ground		
3	GND	Power	Electrical Ground		
4	GND	Power	Electrical Ground		
5	GND	Power	Electrical Ground		
6	P0.25	I/O	GPIO	P0.25	
7	P0.26	I/O	GPIO	P0.26	
8	P0.27	I/O	GPIO	P0.27	
9	P0.28	I/O	GPIO/AIN4	P0.28	Standard drive, low frequency I/O only (<10 kHz)
10	P0.29	I/O	GPIO/AIN5	P0.29	Standard drive, low frequency I/O only (<10 kHz)
11	P0.30	I/O	GPIO/AIN6	P0.30	Standard drive, low frequency I/O only (<10 kHz)
12	P0.31	I/O	GPIO/AIN7	P0.31	Standard drive, low frequency I/O only (<10 kHz)
13	P0.00	I/O	GPIO/XTAL1 (32.768 kHz)	P0.00	
14	P0.01	I/O	GPIO/XTAL2 (32.768 kHz)	P0.01	
15	P0.02	I/O	GPIO/AIN0	P0.02	Standard drive, low frequency I/O only (<10 kHz)
16	GND	Power	Electrical Ground		
17	VCC	Power I/O	LV Mode: 1.7 V to 3.6 V in HV Mode: 1.8 V to 3.3 V supply out <sup>1</sup>	VDD	An internal 4.7 $\mu$ F bulk capacitor is included on the module. However, it is good design practice to add additional bulk capacitance as required for your application, i.e. those with heavy GPIO usage and/or current draw.
18	GND	Power	Electrical Ground		
19	P0.03	I/O	GPIO/AIN1	P0.03	Standard drive, low frequency I/O only (<10 kHz)
20	P0.04	I/O	GPIO/AIN2	P0.04	
21	P0.05	I/O	GPIO/AIN3	P0.05	
22	P0.06	I/O	GPIO	P0.06	
23	P0.07	I/O	GPIO/TRACECLK	P0.07	
24	P0.08	I/O	GPIO	P0.08	

<sup>1</sup> In HV mode, VCC acts as a regulated supply that can power other external devices. The voltage output of VCC can be configured in software but is limited to no more than VCCH-0.3 V. In System Off mode, VCC can supply no more than 1mA.

No.	Name	I/O	Description	nRF52 pin	Remarks
25	P0.09	I/O	GPIO/NFC1	P0.09	Standard drive, low frequency I/O only (<10 kHz)
26	P0.10	I/O	GPIO/NFC2	P0.10	Standard drive, low frequency I/O only (<10 kHz)
27	P0.11	I/O	GPIO/TRACEDATA[2]	P0.11	
28	P0.12	I/O	GPIO/TRACEDATA[1]	P0.12	
29	GND	Power	Electrical Ground		
30	GND	Power	Electrical Ground		
31	P0.13	I/O	GPIO	P0.13	
32	P0.14	I/O	GPIO	P0.14	
33	P0.15	I/O	GPIO	P0.15	
34	P0.16	I/O	GPIO	P0.16	
35	P0.17	I/O	GPIO	P0.17	
36	P0.21	I/O	GPIO	P0.21	
37	P0.19	I/O	GPIO	P0.19	
38	P0.20	I/O	GPIO	P0.20	
39	P0.18	I/O	GPIO/RESET_N	P0.18	
40	P0.22	I/O	GPIO	P0.22	
41	P0.23	I/O	GPIO	P0.23	
42	P0.24	I/O	GPIO	P0.24	
43	SWCLK	I	SWD Clock	SWDCLK	
44	SWDIO	I/O	SWD IO	SWDIO	
45	GND	Power	Electrical Ground		
46	GND	Power	Electrical Ground		
47	GND	Power	Electrical Ground		
48	P1.05	I/O	GPIO	P1.05	Standard drive, low frequency I/O only (<10 kHz)
49	P1.06	I/O	GPIO	P1.06	Standard drive, low frequency I/O only (<10 kHz)
50	P1.07	I/O	GPIO	P1.07	Standard drive, low frequency I/O only (<10 kHz)
51	P1.08	I/O	GPIO	P1.08	
52	P1.09	I/O	GPIO/TRACEDATA[3]	P1.09	
53	P1.10	I/O	GPIO	P1.10	Standard drive, low frequency I/O only (<10 kHz)
54	P1.11	I/O	GPIO	P1.11	Standard drive, low frequency I/O only (<10 kHz)
55	GND	Power	Electrical Ground		
56	P1.00	I/O	GPIO/TRACEDATA[0]/SWO	P1.00	
57	P1.01	I/O	GPIO	P1.01	Standard drive, low frequency I/O only (<10 kHz)
58	P1.02	I/O	GPIO	P1.02	Standard drive, low frequency I/O only (<10 kHz)
59	P1.03	I/O	GPIO	P1.03	Standard drive, low frequency I/O only (<10 kHz)
60	P1.04	I/O	GPIO	P1.04	Standard drive, low frequency I/O only (<10 kHz)
61	P1.12	I/O	GPIO	P1.12	Standard drive, low frequency I/O only (<10 kHz)
62	P1.13	I/O	GPIO	P1.13	Standard drive, low frequency I/O only (<10 kHz)
63	P1.14	I/O	GPIO	P1.14	Standard drive, low frequency I/O only (<10 kHz)
64	P1.15	I/O	GPIO	P1.15	Standard drive, low frequency I/O only (<10 kHz)
65	VCCH	Power	LV Mode: Connect to VCC HV Mode: 2.5 V to 5.5 V in	VDDH	An internal 4.7 $\mu$ F bulk capacitor is included on the module. However, it is good design practice to add additional bulk capacitance as required for your application, i.e. those with heavy GPIO usage or current draw.

No.	Name	I/O	Description	nRF52 pin	Remarks
66	VBUS	Power	USB PHY supply: 4.35 V to 5.5 V in Connect to USB Host device 5 V supply	VBUS	Connect to USB host device 5 V supply
67	USB-D-	I/O	USB Data-	D-	
68	USB-D+	I/O	USB Data+	D+	

**Table 2: BMD-341 pin-out**

## 2.2 Peripheral pins

The BMD-341 features a pin multiplexing system that allows most internal peripherals, such as UART and SPI, to be used on any GPIO pin. This freedom in pin choice enables better optimization of designs and PCB layout.

Only one peripheral signal can be multiplexed to a GPIO pin at a time. Some functions are restricted to certain pins due to additional internal circuitry required by the interface. These include: Trace signals, analog inputs, XTAL signals, USB signals, SWD interface, and reset. See Table 3.

Peripheral	Signal	Pin options
UART0, UART1, I2C0, I2C1, SPI0, SPI1, SPI2, SPI3, I2S0, QSPI0, PDM0, PWM0, PWM1, PWM2, PWM3	All	P0.00-P0.31, P1.00-P1.15
ADC, COMP, LPCOMP	All	P0.02-P0.05, P0.28-P0.31 (AIN0-AIN7)
NFC	NFC1 NFC2	P0.09 P0.10
Reset	RESET_N	P0.18
Trace	TRACECLK SWO/TRACEDATA[0] TRACEDATA[1] TRACEDATA[2] TRACEDATA[3]	P0.07 P1.00 P0.12 P0.11 P1.09
SWD	SWD Clock SWD IO	SWCLK SWDIO
32.768 kHz Crystal	XTAL1 XTAL2	P0.00 P0.01
USB	USB Data + USB Data -	USB-D+ USB-D-

**Table 3: Peripheral pin options**

Some peripherals on the BMD-341 share the same memory location for their registers. This means that only one of these peripherals can be used at a time. It is possible to switch between peripherals that share the same register location by clearing and reinitializing the associated configuration registers. See Nordic Semiconductor nRF52840 Product Specification for details.

Peripheral ID	Base address	Shared peripherals
3	0x40003000	SPI0 I2C0
4	0x40004000	SPI1 I2C1

**Table 4: Peripherals with shared registers**

## 2.3 BMD-300 series footprint compatibility and migration

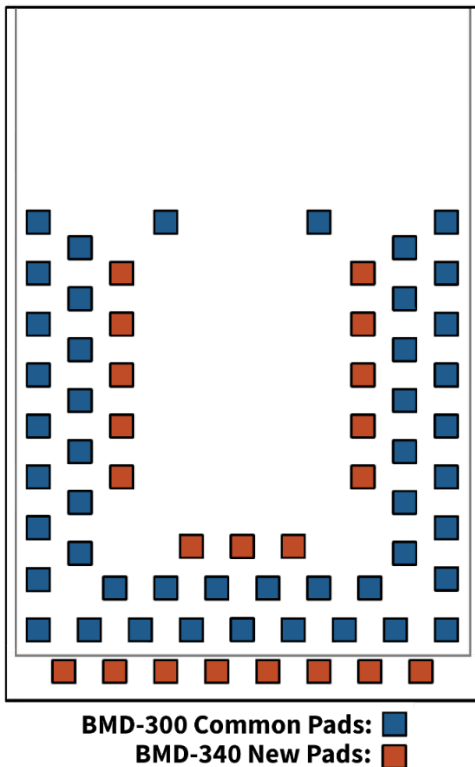

Figure 3: BMD-340/341 and BMD-300/301/330/360 footprint comparison

The BMD-341 footprint is identical to the BMD-340 and has been designed to allow for backwards compatibility with the BMD-300, BMD-301, BMD-330, and BMD-360 modules with pins 1 through 47 of the BMD-341 directly mapping to the same pin numbers on the BMD-300/301/330/360. This allows BMD-300, BMD-301, BMD-330, and BMD-360 modules to be placed directly onto the BMD-341 footprint for easy migration and enabling tiered product design. Care should be taken to follow ground plane and keep-out areas if designing for modules with an integrated antenna.

Generally, all pin names and functions remain the same, except for some differences noted below. Pins 48 through 68 of the BMD-341 footprint are new pads used for new features that are not present on the BMD-300/301/330/360 modules, such as USB interface and additional GPIO and power connections.

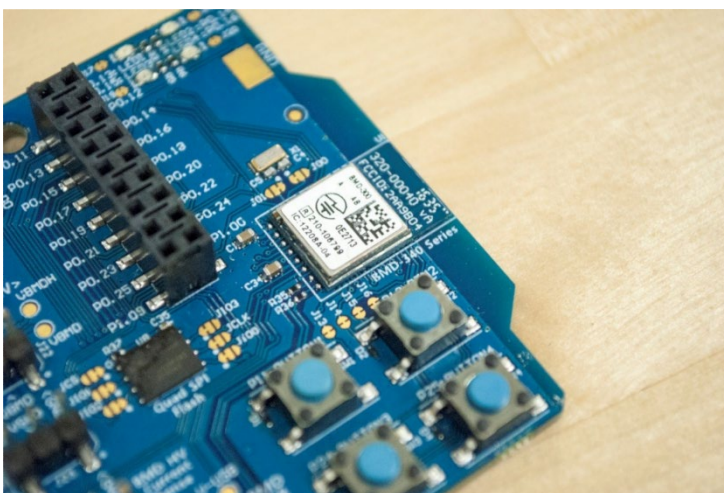

Figure 4: BMD-300 Module soldered to BMD-340/341 footprint

### 2.3.1 BMD-300/301/330/360 to BMD-341 pad differences

Due to changes in the nRF52840 SoC used by the BMD-341, not all functions (such as SWO/TRACE signals) are found on the same pins as on the BMD-300/301/330/360. Particularly of note is the reset pin function which on the BMD-341 is now available on P0.18 instead of P0.21 as on the BMD-300/301/330/360. To maintain pin for pin compatibility of the reset signal, P0.18 and P0.21 have swapped pad locations on the BMD-341 footprint. These differences are detailed in Table 5 below:

Pin	BMD-300/301 Name	BMD-300/301 Function	BMD-341 Name	BMD-341 Function
39	P0.21	GPIO/RESET_N	P0.18	GPIO/RESET_N
38	P0.20	GPIO/TRACECLK	P0.20	GPIO
36	P0.18	GPIO/TRACEDATA[0]/SWO	P0.21	GPIO
34	P0.16	GPIO/TRACEDATA[1]	P0.16	GPIO
33	P0.15	GPIO/TRACEDATA[2]	P0.15	GPIO
32	P0.14	GPIO/TRACEDATA[3]	P0.14	GPIO
23	P0.07	GPIO	P0.07	GPIO/TRACECLK
56	N/A	N/A	P1.00	GPIO/TRACEDATA[0]/SWO
28	P0.12	GPIO	P0.12	GPIO/TRACEDATA[1]
27	P0.11	GPIO	P0.11	GPIO/TRACEDATA[2]
52	N/A	N/A	P1.09	GPIO/TRACEDATA[3]

Table 5: BMD-300/301/330/360 to BMD-341 Pad differences

### 2.3.2 BMD-300/301/330/360 to BMD-341 design migration

Existing designs incorporating the BMD-300, BMD-301, BMD-330 or BMD-360 module can be migrated over to the BMD-341 with the addition of a single footprint pad for **VCCH** (pin 65). This migration option is only suitable for applications that do not require the new USB interface, additional GPIO, or higher supply voltage functionality. The **VCCH** pad must be present and electrically connected to the same supply as VCC for the module to operate correctly. Vias underneath the BMD-341 should be tented to avoid shorts to unused module pads. Firmware written for the BMD-300/301/330/360 can generally be ported to the BMD-341 with minimal effort. See the Nordic Semiconductor SDK documentation for details.

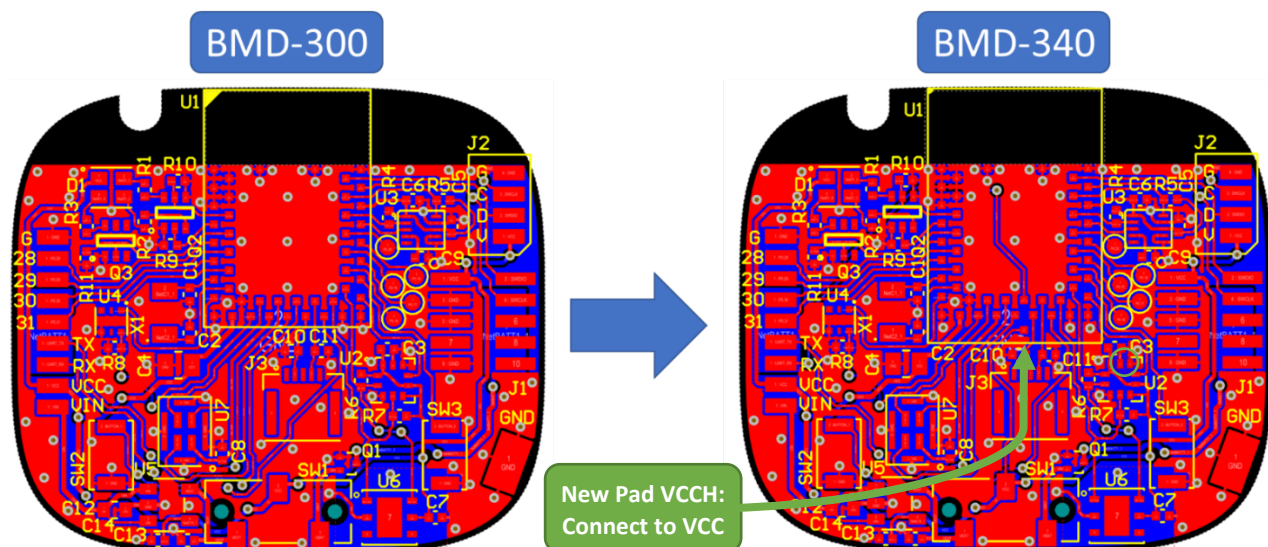



Figure 5: BMD-300 to BMD-341 migration example

Using the BMD-341 minimal footprint, with only the additional VCCH pad added, allows BMD-300 designs to gain the following BMD-341 features with typically minor layout re-work:

- Bluetooth 5 long range modes
- IEEE 802.15.4 (Thread and Zigbee) connectivity
- Doubled Flash memory (1 MB vs. 512 kB)
- Quadrupled RAM (256 kB vs. 64 kB)
- Arm® TrustZone® Cryptocell 310 security co-processor

To take advantage of new hardware features, such as the additional UART and Quad SPI interface, the full BMD-341 footprint should be used. Designs that require the 5V DCDC converter, trace interface, USB interface, or the additional GPIO (P1.00-P1.15) must use the full BMD-341 footprint.

 Since the BMD-300/301/330/360 can be soldered to the full BMD-340/341 footprint, it is highly recommended that all new BMD-300/301/330/360 and BMD-340/341 projects use the full BMD-340/341 footprint. When migrating designs, the full BMD-341 footprint should be used whenever possible as it is better suited for use with mass production SMT processing. Care should be taken to follow ground plane and keep-out areas if designing for modules with an integrated antenna.

## 2.4 BMD-341 fan-out example

The following figure is a BMD-341 fan-out example on a simple 2-layer PCB. This example is powered via VCCH from a USB connection. See section 3.3 for details on power and DCDC operation.

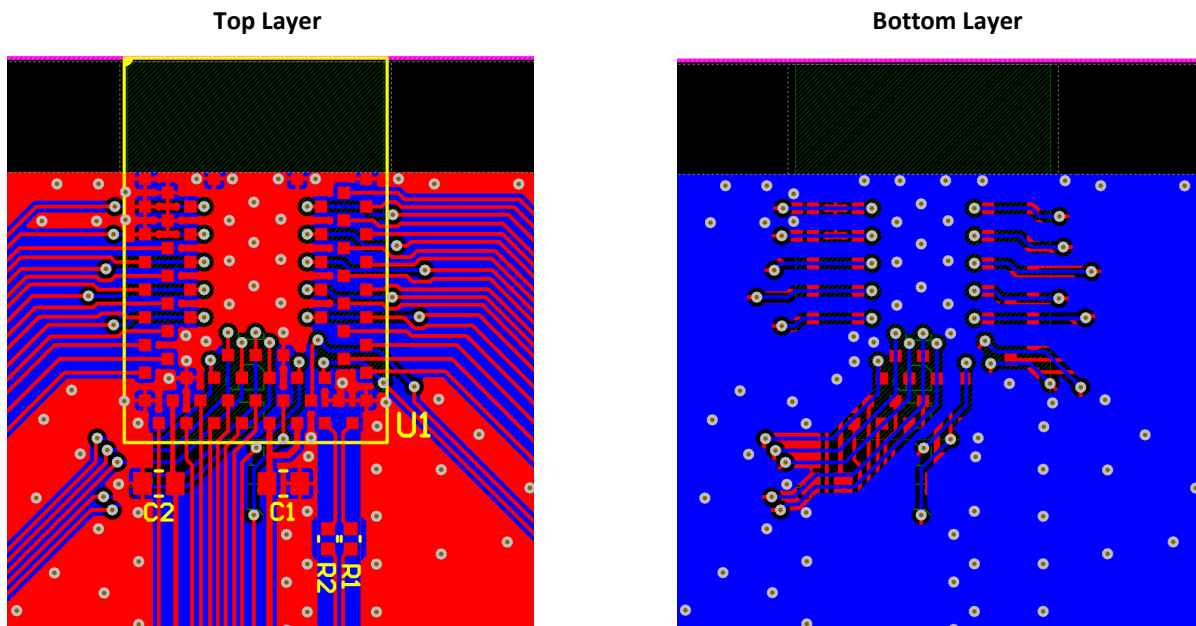

Figure 6: BMD-341 two-layer fan-out example

### 3 Electrical specifications

Stressing the device above one or more of the ratings listed in the Absolute maximum rating section may cause permanent damage. These are stress ratings only. Operating the module at these or at any conditions other than those specified in the Operating conditions section of this document should be avoided. Exposure to absolute maximum rating conditions for extended periods may affect device reliability.

Operating condition ranges define those limits within which the functionality of the device is guaranteed. Where application information is given, it is advisory only and does not form part of the specification.

#### 3.1 Absolute maximum ratings

Symbol	Description	Min	Max	Unit
$V_{CC\_MAX}$	Voltage on VCC supply pin	-0.3	3.9	V
$V_{CCH\_MAX}$	Voltage on VCCH supply pin	-0.3	5.8	V
$V_{BUS\_MAX}$	Voltage on VBUS supply pin	-0.3	5.8	V
$V_{IO\_MAX}$	Voltage on GPIO pins ( $V_{CC} > 3.6V$ )	-0.3	3.9	V
$V_{IO\_MAX}$	Voltage on GPIO pins ( $V_{CC} \leq 3.6V$ )	-0.3	$V_{CC}+0.3V$	V
$T_S$	Storage Temperature Range	-40	125	°C

**Table 6: Absolute maximum ratings**

The product is not protected against overvoltage or reversed voltages. If necessary, voltage spikes exceeding the power supply voltage specification, given in table above, must be limited to values within the specified boundaries by using appropriate protection devices.

#### 3.2 Operating conditions

Unless otherwise specified, all operating condition specifications are at an ambient temperature of 25 °C and a supply voltage of 3.3 V.

Operation beyond the specified operating conditions is not recommended and extended exposure beyond them may affect device reliability.

Symbol	Parameter	Min	Typ.	Max	Unit
$V_{CC\_IN}$	VCC operating supply voltage in	1.7	3.0	3.6	V
$V_{CC\_START}$	VCC DCDC starting voltage	1.75	-	-	V
$V_{CCH\_HV}$	VCCH operating supply voltage in	2.5	5.0	5.5	V
$V_{BUS\_IN}$	VBUS operating supply voltage in	4.35	5.0	5.5	V
$T_{R\_VCC}$	VCC Supply rise time (0 V to 1.7 V)	-	-	60	ms
$T_{R\_VCCH}$	VCCH Supply rise time (0 V to 3.7 V) <sup>2</sup>	-	-	100	ms
$T_A$	Operating Ambient Temperature Range	-40	25	85	°C

**Table 7: Operating conditions**

<sup>2</sup> Applies when the module is configured to use HV mode. When using LV mode  $T_{R\_VCC}$  applies. See Nordic Semiconductor nRF52840 Rev 1 errata [202] for details on  $T_{R\_VCCH}$  requirement.



### 3.3 Power and DCDC configuration

 The BMD-341 is based on the nRF52840, silicon revision 2 or newer IC.

The BMD-341 has two internal regulator stages that each contains an LDO and DCDC regulator. The first regulator, REG0, is fed by the **VCCH** pin and can accept a source voltage of 2.5 V to 5.5 V. The output of REG0 is connected to the **VCC** pin and the input of the second regulator stage REG1. REG1 supplies power to the module core and can accept an input source voltage of 1.7 V to 3.6 V. Depending on how the **VCC** and **VCCH** pins are connected, the module will operate in one of two modes: Normal/Low Voltage (LV) or High Voltage (HV). The voltage present on the **VCC** pin is always the GPIO high logic level voltage, regardless of power mode.

To enter LV Mode, the same source voltage is applied to both the **VCC** and **VCCH** pins causing REG0 to automatically shut down leaving only the REG1 stage active. To enter HV, the source voltage is only applied to **VCCH** causing the **VCC** pin to become an output source supplied by REG0.

Mode	Pin	Name	Connection
Normal (LV)	17	VCC	1.7 V to 3.6 V source in
	65	VCCH	Same source as VCC
High Voltage (HV)	17	VCC	1.8 V to 3.3 V supply out
	65	VCCH	2.5 V to 5.5 V source in

**Table 8: Power mode pin connections**

 **Important:** In both LV and HV mode, the GPIO logic level voltage is determined by the **VCC** pin. In HV mode, all external devices that are connected to the BMD-341's GPIO must either be powered by the module (from **VCC**) or use level translation.

REG0 can supply a maximum current of 25 mA for the module and external circuits in System On Mode and 1 mA in System Off Mode. External circuits powered from **VCC** in HV mode should be limited to no more than 5 mA to ensure stability at all radio transmit power levels.

#### 3.3.1 USB power

The USB interface on the BMD-341 can be used when the module is in either Normal (LV) or High Voltage (HV) mode. The BMD-341 USB PHY is powered by a dedicated, internal LDO regulator that is fed by the **VBUS** pin (66). This means that applying power to only the **VBUS** pin will not power the rest of the module. For the USB PHY to operate, **VBUS** must be externally powered.



### 3.3.2 Normal (LV) power mode examples

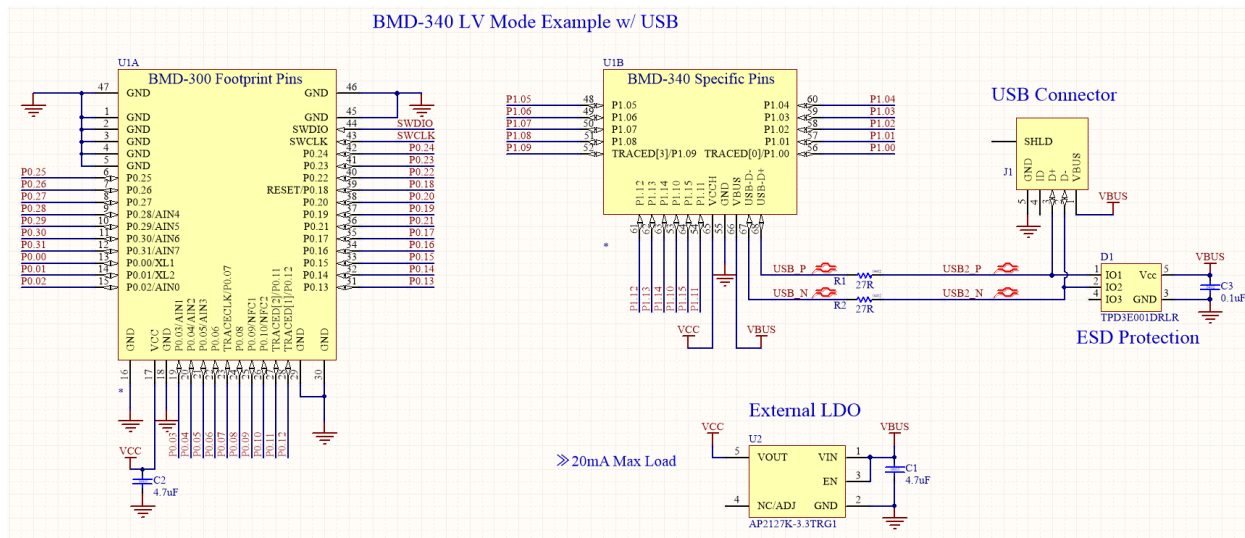
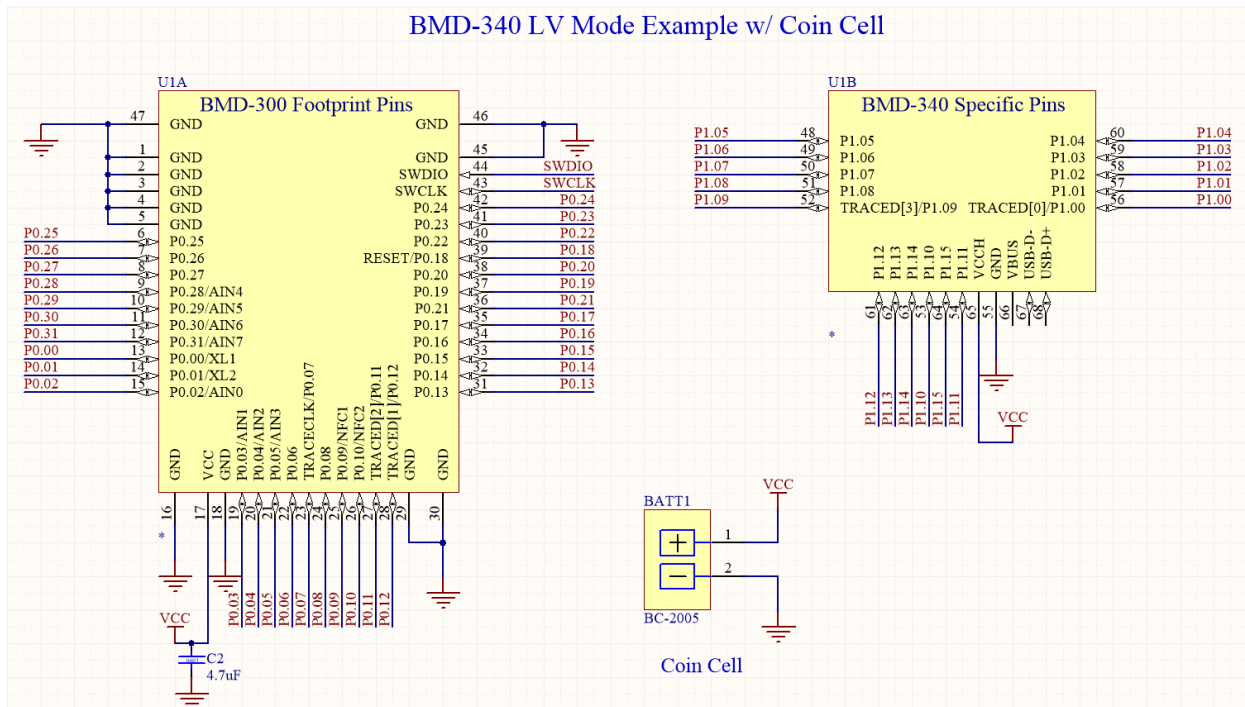

### 3.3.3 High voltage (HV) power mode examples

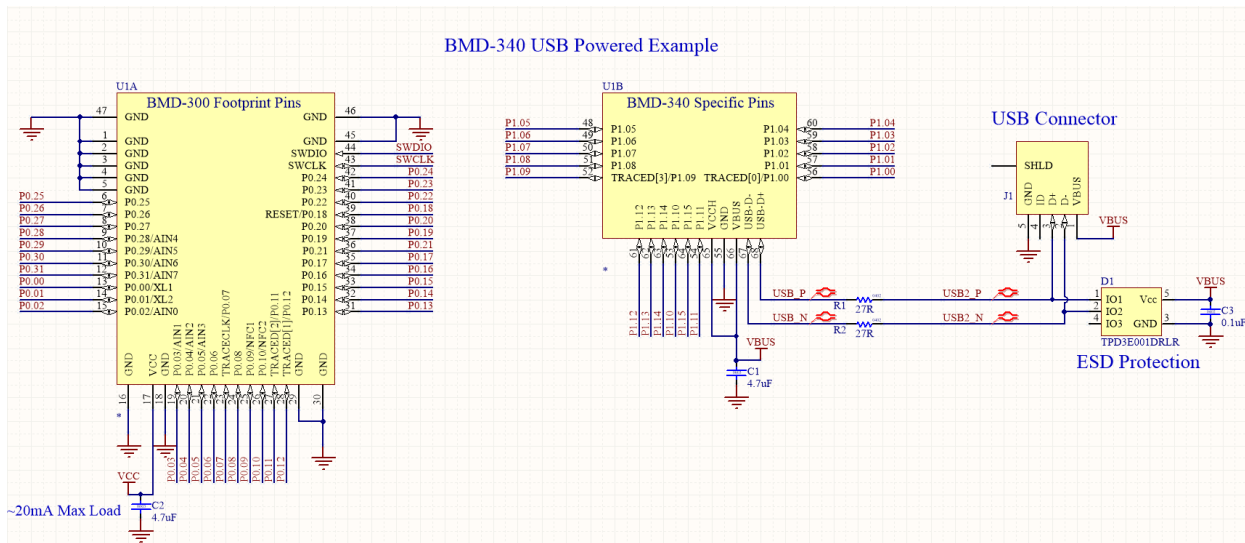

Figure 9: BMD-340/341 USB-powered HV mode example

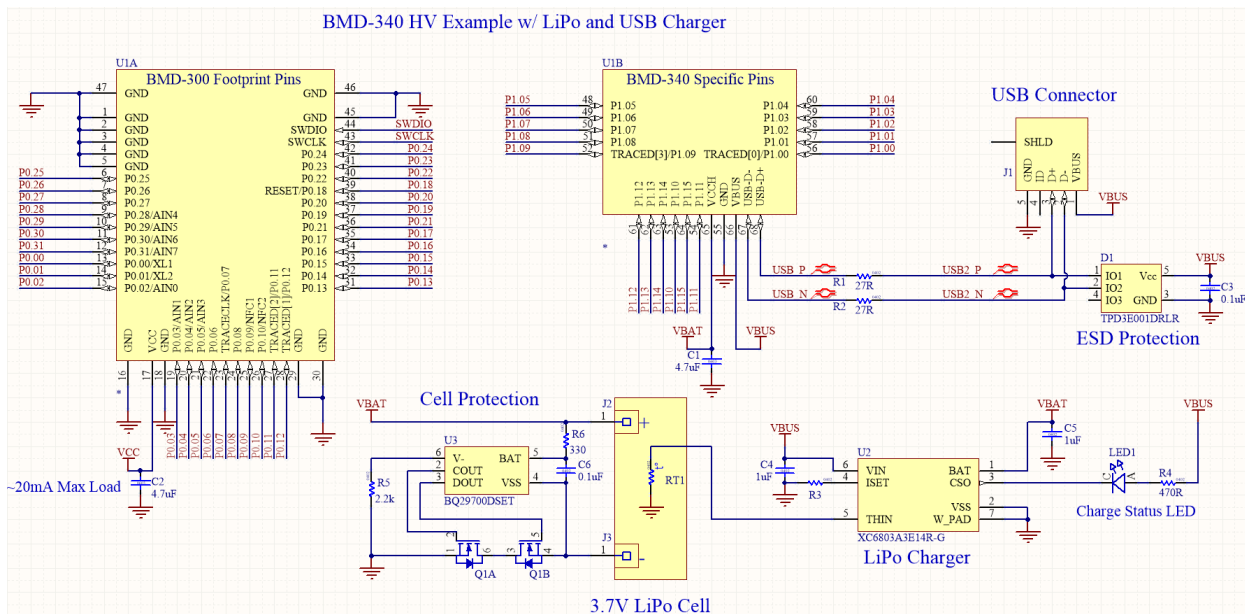

Figure 10: BMD-340/341 LiPo-powered HV example with USB charger

**⚠ Important:** The LiPo circuit above is meant to be a generic example of how the BMD-341's power modes can be used. Great care must be taken when integrating Lithium-Ion batteries into a design. Protection circuits suitable for the type of battery used and the application must always be implemented.

### 3.4 General purpose I/O

The general purpose I/O is organized as two ports enabling access and control of the 48 available GPIO pins. The first port allows access of P0.00 to P0.31, similar to the one port available on the BMD-300/301. The second port, new to the BMD-341, allows access to P1.00 to P1.15. Each GPIO can be accessed individually with the following user configurable features:

- Input/output direction
- Output drive strength
- Internal pull-up and pull-down resistors
- Wake-up from high- or low-level triggers on all pins
- Trigger interrupt on all pins
- All pins can be used by the PPI task/event system; the maximum number of pins that can be interfaced through the PPI at the same time is limited by the number of GPIOTE channels
- All pins can be individually configured to carry serial interface or quadrature demodulator signals

Symbol	Parameter	Min.	Typ.	Max.	Unit
V <sub>IH</sub>	Input High Voltage	0.7 x VCC	-	VCC	V
V <sub>IL</sub>	Input Low Voltage	GND	-	0.3 x VCC	V
V <sub>OH</sub>	Output High Voltage	VCC - 0.4	-	VCC	V
V <sub>OL</sub>	Output Low Voltage	GND	-	GND + 0.4	V
R <sub>PU</sub>	Pull-up Resistance	11	13	16	kΩ
R <sub>PD</sub>	Pull-down Resistance	11	13	16	kΩ

Table 9: GPIO electrical specifications

### 3.5 Module reset

GPIO pin P0.18 may be used for a hardware reset. To utilize P0.18 as a hardware reset, the UICR registers PSELRESET[0] and PSELRESET[1] must be set alike, to the value of 0x7FFFFFFD2. When P0.18 is programmed as **RESET\_N**, the internal pull-up is automatically enabled. Nordic Semiconductor example applications and development kits program P0.18 as **RESET\_N**.

### 3.6 Debug and programming

The BMD-341 supports the two pin Serial Wire Debug (SWD) interface and offers flexible and powerful mechanism for non-intrusive debugging of program code. Breakpoints, single stepping, and instruction trace capture of code execution flow are part of this support.

The BMD-341 also supports ETM and ITM trace. The trace data from the ETM and the ITM is sent to an external debugger via a 4-bit wide parallel trace port. In addition to parallel trace, the TPIU supports serial trace via the Serial Wire Output (SWO) trace protocol.

## 3.7 Clocks

The BMD-341 requires two clocks, a high frequency clock and a low frequency clock. The high frequency clock is provided on-module by a high-accuracy 32 MHz crystal as required by the nRF52840 for radio operation.

The low frequency clock can be provided internally by an RC oscillator or synthesized from the fast clock, or externally by a 32.768 kHz crystal. An external crystal provides the lowest power consumption and greatest accuracy. Using the internal RC oscillator with calibration provides acceptable performance for Bluetooth low energy applications at a reduced cost and slight increase in power consumption.

### 3.7.1 32.768 kHz crystal (LFXO)

Symbol	Parameter	Typ.	Max.	Unit
$F_{NOM\_LFXO}$	Crystal frequency	32.768	-	kHz
$F_{TOL\_LFXO\_BLE}$	Frequency tolerance, Bluetooth low energy applications <sup>3</sup>	-	±500	ppm
$f_{TOL\_LFXO\_ANT}$	Frequency Tolerance, ANT applications <sup>4</sup>	-	±50	ppm
$C_{L\_LFXO}$	Load Capacitance	-	12.5	pF
$C_{O\_LFXO}$	Shunt Capacitance	-	2	pF
$R_{S\_LFXO}$	Equivalent series resistance	-	100	kΩ
$C_{pin}$	Input Capacitance on XL1 & XL2 pads	4	-	pF

Table 10: 32.768 kHz crystal (LFXO)

### 3.7.2 32.768 kHz clock source comparison

Symbol	Parameter	Min.	Typ.	Max.	Unit
$I_{LFXO}$	Current for 32.768 kHz Crystal Oscillator	-	0.23	-	μA
$I_{LFRC}$	Current for 32.768 kHz RC Oscillator	-	0.7	1	μA
$I_{LFSYNT}$	Current for 32.768 kHz Synthesized Oscillator	-	100	-	μA
$f_{TOL\_LFXO\_BLE}$	Frequency Tolerance, 32.768 kHz Crystal Oscillator (Bluetooth low energy Stack) <sup>2</sup>	-	-	±500	ppm
$f_{TOL\_LFXO\_ANT}$	Frequency Tolerance, 32.768 kHz Crystal Oscillator (ANT Stack) <sup>3</sup>	-	-	±50	ppm
$f_{TOL\_LFRC}$	Frequency Tolerance, 32.768 kHz RC Oscillator	-	-	±5	%
$f_{TOL\_CAL\_LFRC}$	Frequency tolerance, 32.768 kHz RC after calibration	-	-	±500	ppm
$f_{TOL\_LFSYNT}$	Frequency Tolerance, 32.768 kHz Synthesized Oscillator	-	-	±48	ppm

Table 11: 32.768 kHz clock source comparison

<sup>3</sup>  $f_{TOL\_LFXO\_BLE}$  and  $f_{TOL\_LFXO\_ANT}$  are the maximum allowed for Bluetooth low energy and ANT applications. Actual tolerance depends on the crystal used.

<sup>4</sup> The ANT protocol requires the use of an external crystal.

## 4 Firmware

Projects for the BMD-341 should utilize the [Nordic Semiconductor SDK](#) and the nRF52840 tools for new development. This will allow access to the very latest Bluetooth support from Nordic Semiconductor and provide an ongoing path as new features are released.

### 4.1 Factory image

The BMD-341 module is not loaded with a factory firmware image. The unique, public IEEE Bluetooth device address is printed on the module label and is also programmed into the UICR.

### 4.2 SoftDevices

Nordic Semiconductor protocol stacks for Bluetooth and ANT are known as SoftDevices. SoftDevices are pre-compiled, pre-linked binary files. SoftDevices can be programmed in nRF52 series SoCs and are downloadable from the Nordic Semiconductor website. The BMD-341 with the nRF52840 SoC supports the S140 (Bluetooth low energy Central & Peripheral) and S340 (ANT and Bluetooth low energy) SoftDevices.

#### 4.2.1 S140

The SoftDevice S140 is a feature complete Bluetooth 5 qualified protocol stack for the nRF52840 SoC. It supports up to 20 concurrent links in all roles. It supports Bluetooth 5 features: 2 Mbps, Long Range, Advertising Extensions and channel selection algorithm #2(CSA #2). The number of connections and bandwidth per connection are configurable, offering memory and performance optimization.

It is a complete stack with GAP, GATT, ATT, SM, L2CAP, and Link Layer. Both GATT Server and Client are supported. The broad feature set also includes Privacy 1.2, LE Data Length Extension (DLE), configurable ATT MTU, L2CAP connection-oriented channels and LE Secure Connections.

SoftDevice S140 is available for download [here](#).

#### 4.2.2 S340

SoftDevice S340 is a combined Bluetooth 5 and ANT™ protocol stack for the nRF52840 SoC, supporting concurrent operation of the two.

It is a Bluetooth 5 qualified protocol stack that offers up to 20 concurrent links in all roles. It supports all Bluetooth 5 features: 2 Mbps, Long Range, Advertising Extensions and channel selection algorithm #2 (CSA #2). The number of connections and bandwidth per connection is configurable, offering memory and performance optimization.

It is a complete Bluetooth LE stack with GAP, GATT, ATT, SM, L2CAP, and Link Layer. Both GATT Server and Client are supported. The broad feature set also includes Privacy 1.2, LE Data Length Extension (DLE), configurable ATT MTU, L2CAP connection-oriented channels and LE Secure Connections.

It supports all ANT features and offers a variety of network topologies, including peer-to-peer, star and tree. Up to 15 individual channels are available, with broadcast, acknowledged, or burst transfer communication.

SoftDevice S340 is available for download [here](#).

### 4.2.3 IEEE 802.15.4 (Thread and Zigbee)

IEEE 802.15.4 based protocols, such as Thread and Zigbee, on the BMD-341 are not implemented using a SoftDevice. Nordic Semiconductor provides an IEEE 802.15.4 compliant MAC stack which does not require a SoftDevice to be loaded to operate. Nordic Semiconductor also provides pre-compiled Thread and Zigbee stacks. See the [Nordic Semiconductor SDK](#) for more information on developing applications that utilize IEEE 802.15.4. Both allow for concurrent operation with Bluetooth low energy SoftDevices.

## 4.3 Bluetooth device address

The BMD-341 module is preprogrammed from the factory with a unique public Bluetooth device (MAC) address stored in the CUSTOMER[0] and CUSTOMER[1] registers of the User Information Configuration Registers (UICR). The Bluetooth device address consists of the IEEE Organizationally Unique Identifier (OUI) combined with the six hexadecimal digits that are printed on a 2D barcode and in human-readable text on the module label, as described in section 5.3. The Bluetooth device address is stored in little endian format. The most significant bytes of the CUSTOMER[1] register are 0xFF to complete the 32-bit register.

UICR Register	Address	Description	Remarks
CUSTOMER[0]	0x10001080	Bluetooth_addr [0] (0xFF)	Example value. Actual value printed on label
CUSTOMER[0]	0x10001081	Bluetooth_addr [1] (0xEE)	Example value. Actual value printed on label
CUSTOMER[0]	0x10001082	Bluetooth_addr [2] (0xDD)	Example value. Actual value printed on label
CUSTOMER[0]	0x10001083	Bluetooth_addr [3] (0xCC)	IEEE OUI <sup>5,6</sup>
CUSTOMER[1]	0x10001084	Bluetooth_addr [4] (0xBB)	IEEE OUI <sup>5,6</sup>
CUSTOMER[1]	0x10001085	Bluetooth_addr [5] (0xAA)	IEEE OUI <sup>5,6</sup>
CUSTOMER[1]	0x10001086	0xFF	Unused
CUSTOMER[1]	0x10001087	0xFF	Unused

**Table 12: Bluetooth device address**

<sup>5</sup> The IEEE OUI for type number BMD-341-A-R-00 is: 94:54:93. The full Bluetooth device address is stored in the UICR.

<sup>6</sup> Type number BMD-341-A-R-10 encodes the full Bluetooth device address in the label data matrix and is stored in the UICR.

## 5 Mechanical specifications

### 5.1 Dimensions

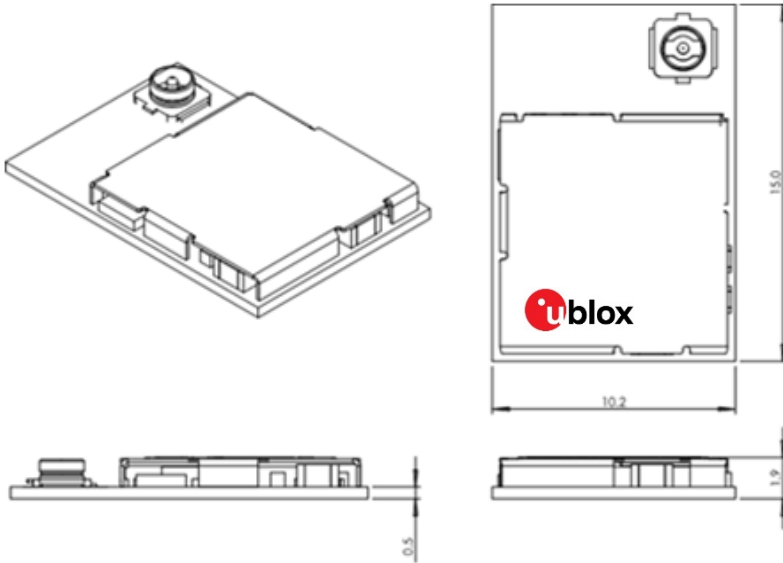

Length:  $\pm 0.3$  mm, Width:  $\pm 0.3$  mm, Height:  $\pm 0.1$  mm

Figure 11: BMD-341 mechanical drawing

### 5.2 Recommended PCB land pads

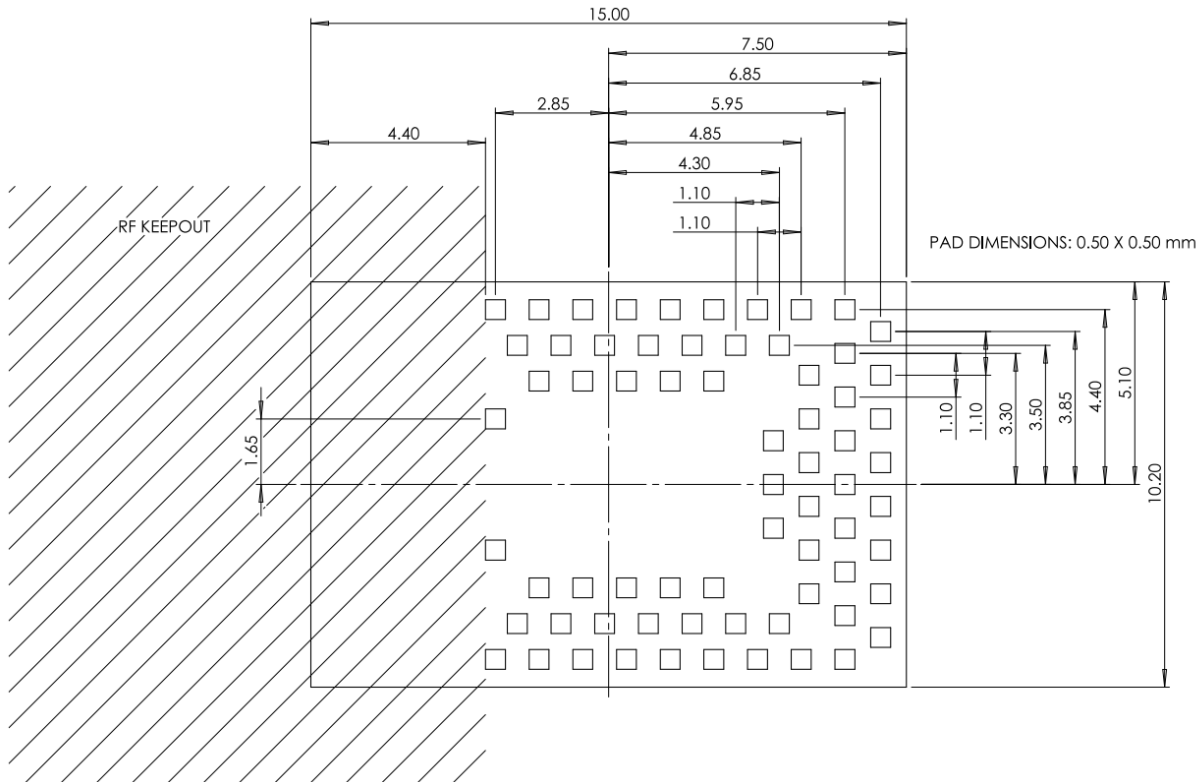

Figure 12: Recommended PCB land pads

There is no RF keep-out area required for the BMD-341. However, including it allows for drop-in compatibility with the BMD-340.

### 5.3 Module marking

The label of the BMD-341 module includes important product information, as described in this section.

#### 5.3.1 Module marking for type number BMD-341-A-R-00

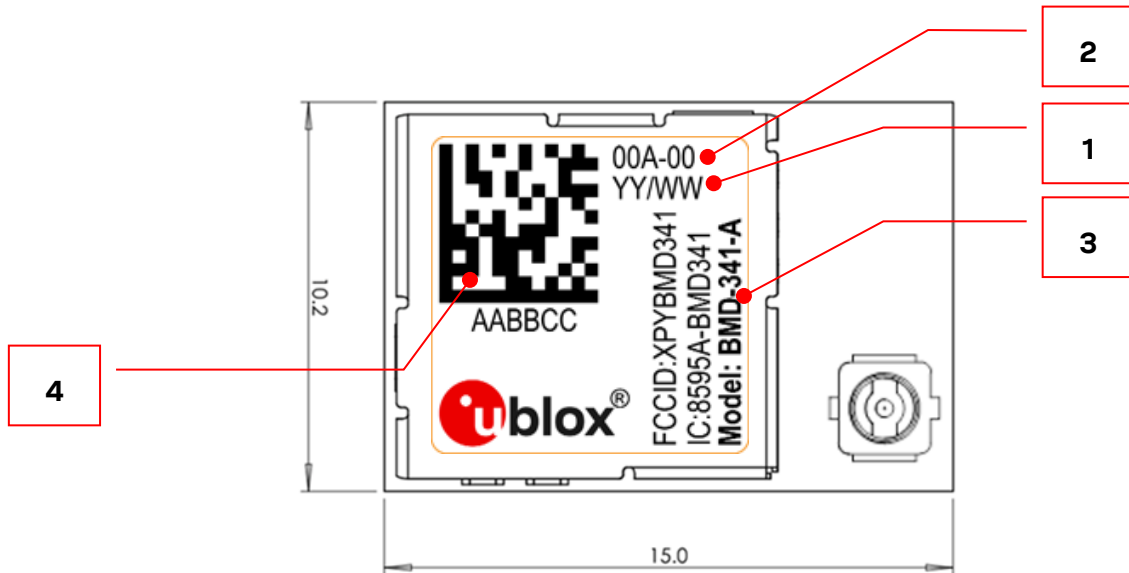

Figure 13: Module marking for type number BMD-341-A-R-00

Reference	Description
1	Date of unit production (year/week)
2	Product version
3	Product name
4	Data Matrix with unique serial number of 6 alphanumeric symbols, also in human-readable form. The full Bluetooth device address consists of the IEEE OUI (94:54:93) with the six symbols appended: 94:54:93:AA:BB:CC

Table 13: BMD-341-A-R-00 label description



### 5.3.2 Module marking for type number BMD-341-A-R-10

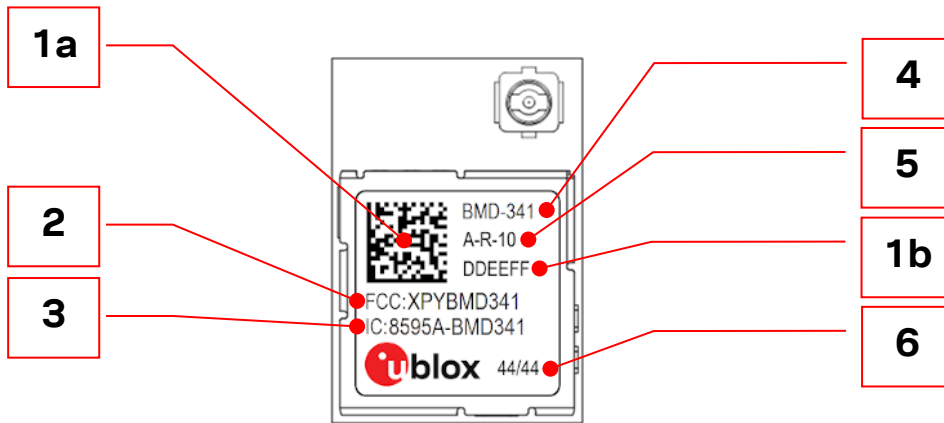

**Figure 14: Module marking for type number BMD-341-A-R-10**

Reference	Description
1a	Data Matrix with unique serial number of 19 alphanumeric symbols. The first 3 symbols represent module type number unique to each module variant, the next 12 symbols represent the unique hexadecimal Bluetooth device address of the module AABBCCDDEEFF, and the last 4 symbols represent the hardware and firmware version encoded HHFF.
1b	Second half of Bluetooth device address in human-readable format (DDEEFF above)
2	FCC ID (USA)
3	ISED (IC) ID (Canada)
4	Product name (Model)
4+5	Product type number
6	Date of production encoded YY/WW (year / week)

**Table 14: Module marking for type number BMD-341-A-R-10**

## 6 RF design notes

### 6.1 Recommended RF layout and ground plane

Since the BMD-341 relies on an external antenna, there are no ground plane requirements or keep-out area for the module itself. Refer to the external antenna datasheet for antenna placement and grounding recommendations.

### 6.2 Mechanical enclosure

For the BMD-341, refer to the external antenna datasheet for placement in or on a mechanical enclosure.

### 6.3 Approved external antennas

#### 6.3.1 Canada (ISED) Antenna Statement

This radio transmitter [IC: 8595A-BMD341] has been approved by Innovation, Science and Economic Development Canada to operate with the antenna types listed below, with the maximum permissible gain indicated. Antenna types not included in this list that have a gain greater than the maximum gain indicated for any type listed are strictly prohibited for use with this device.

Cet émetteur radio [IC: 8595A-BMD345] a été approuvé par Innovation, Sciences et Développement économique Canada pour fonctionner avec les types d'antennes énumérés ci-dessous, avec le gain maximal admissible indiqué. Les types d'antennes non inclus dans cette liste qui ont un gain supérieur au gain maximum indiqué pour tout type répertorié sont strictement interdits pour une utilisation avec cet appareil.

#### 6.3.2 Antenna List

The antennas listed below were tested for use with the BMD-341.

#	Mfg.	Part Number	Max Gain	Type	Size	Approvals
1	Pulse	W1030	2 dBi	1/4 Wave Dipole – Whip	Length: 108.3mm	FCC, ISED, CE, RCM
2	Taoglas	FXP73.07.0100A	2.5 dBi	1/4 Wave Dipole – Flex	7 mm x 47 mm x 0.1 mm	FCC, ISED, CE, RCM
3	Pulse	W1027	3.2 dBi	1/4 Wave Dipole – Whip	Length: 136.8mm	FCC, ISED, CE, RCM
4	Kinsun	6670113050-145	2.0 dBi	1/4 Wave Dipole – PCB	12 mm x 65 mm x 0.46 mm	FCC, ISED, CE, RCM

**Table 15: BMD-341 Approved external antennas**

## 7 BMD-341 evaluation development kit



u-blox has developed full featured evaluation boards that provide a complete I/O pin out to headers, on-board programming and debugging, 32.768 kHz crystal, power and virtual COM port over USB, BMD-341 USB connector, 64 Mb quad SPI Flash, four user LEDs, and four user buttons. The evaluation boards also provide the option to be powered from a CR2032 coin cell battery or a LiPo battery through a JST-PH connector and have current sense resistors and headers to allow for convenient current measurements. Arduino Mega style headers are provided for easy prototyping of additional functions. The evaluation boards also support programming off-board u-blox modules based on Nordic Semiconductor nRF5 SoCs.

## 8 Qualification and approvals

### 8.1 United States (FCC)

The BMD-341 module has received Federal Communications Commission (FCC) CFR47 Telecommunications, Part 15 Subpart C “Intentional Radiators” modular approval in accordance with Part 15.212 and 15.247. The modular approval allows the end user to integrate the module into a finished product without obtaining subsequent and separate FCC approvals for intentional radiation, provided no changes or modifications are made to the module circuitry. Changes or modifications could void the user’s authority to operate the equipment. The end user must comply with all of the instructions provided by the Grantee, which indicate installation and/or operating conditions necessary for compliance.

The finished product is required to comply with all applicable FCC equipment authorizations regulations, requirements and equipment functions not associated with the transmitter module portion. For example, compliance must be demonstrated to regulations for other transmitter components within the host product; to requirements for unintentional radiators (Part 15 Subpart B “Unintentional Radiators”), such as digital devices, computer peripherals, radio receivers, etc.; and to additional authorization requirements for the non-transmitter functions on the transmitter module (that is, Verification, or Declaration of Conformity) (for example, transmitter modules may also contain digital logic functions) as appropriate.

-  Modification to this product will void the users’ authority to operate this equipment.
-  The OEM is still responsible for verifying end product compliance with FCC Part 15, subpart B limits for unintentional radiators through an accredited test facility.

#### 8.1.1 Labeling and user information requirements

**The BMD-341 is assigned the FCC ID number: XPYBMD341**

If the FCC ID is not visible when the module is installed inside another device, then the outside of the finished product into which the module is installed must also display a label referring to the enclosed module. This exterior label can use the following or similar wording:

Contains FCC ID: XPYBMD341

In addition to marking the product with the appropriate FCC ID, the end product shall bear the following statement in a conspicuous location on the device ([FCC Rules, Title 47, Subchapter A, Part 15, Subpart B, Chapter §15.19](#)):

This device complies with part 15 of the FCC Rules. Operation is subject to the following two conditions: (1) This device may not cause harmful interference, and (2) this device must accept any interference received, including interference that may cause undesired operation.

#### 8.1.2 RF exposure

All transmitters regulated by FCC must comply with RF exposure requirements. [KDB 447498 General RF Exposure Guidance](#) provides guidance in determining whether proposed or existing transmitting facilities, operations or devices comply with limits for human exposure to Radio Frequency (RF) fields adopted by the Federal Communications Commission (FCC).

This module is approved for installation into mobile and/or portable host platforms and must not be co-located or operating in conjunction with any other antenna or transmitter except in accordance with FCC multi-transmitter guidelines. End users must be provided with transmitter operating conditions for satisfying RF Exposure compliance.

## 8.2 Canada (ISED)

The BMD-341 module is certified for use in Canada under Innovation, Science and Economic Development Canada (ISED) Radio Standards Specification (RSS) RSS-247 Issue 2 and RSSGen.

### 8.2.1 Labeling and user information requirements

**The BMD-341 is assigned the IC ID number: 8595A-BMD341**

Labeling Requirements for the Host Device (from Section 3.2.1, RSS-Gen, Issue 3, December 2010): The host device shall be properly labeled to identify the module within the host device. The Industry Canada certification label of a module shall be clearly visible at all times when installed in the host device, otherwise the host device must be labeled to display the Industry Canada certification number of the module, preceded by the words “Contains transmitter module”, or the word “Contains”, or similar wording expressing the same meaning, as follows:

Contains transmitter module IC: 8595A-BMD341

User Manual Notice for License-Exempt Radio Apparatus (from Section 7.1.3 RSS-Gen, Issue 3, December 2010): User manuals for license-exempt radio apparatus shall contain the following or equivalent notice in a conspicuous location in the user manual or alternatively on the device or both:

This device complies with Industry Canada license exempt RSS standard(s). Operation is subject to the following two conditions: (1) this device may not cause interference, and (2) this device must accept any interference, including interference that may cause undesired operation of the device.

Le présent appareil est conforme aux CNR d'Industrie Canada applicables aux appareils radio exempts de licence. L'exploitation est autorisée aux deux conditions suivantes: (1) l'appareil ne doit pas produire de brouillage, et (2) l'utilisateur de l'appareil doit accepter tout brouillage radioélectrique subi, même si le brouillage est susceptible d'en compromettre le fonctionnement.

Transmitter Antenna (from Section 7.1.2 RSS-Gen, Issue 3, December 2010): User manuals for transmitters shall display the following notice in a conspicuous location:

Under Industry Canada regulations, this radio transmitter may only operate using an antenna of a type and maximum (or lesser) gain approved for the transmitter by Industry Canada. To reduce potential radio interference to other users, the antenna type and its gain should be so chosen that the equivalent isotropically radiated power (e.i.r.p.) is not more than that necessary for successful communication.

Conformément à la réglementation d'Industrie Canada, le présent émetteur radio peut fonctionner avec une antenne d'un type et d'un gain maximal (ou inférieur) approuvé pour l'émetteur par Industrie Canada. Dans le but de réduire les risques de brouillage radioélectrique à l'intention des autres utilisateurs, il faut choisir le type d'antenne et son gain de sorte que la puissance isotrope rayonnée équivalente (p.i.r.e.) ne dépasse pas l'intensité nécessaire à l'établissement d'une communication satisfaisante.

### 8.2.2 RF exposure

All transmitters regulated by ISED must comply with RF exposure requirements listed in RSS-102 - Radio Frequency (RF) Exposure Compliance of Radiocommunication Apparatus (All Frequency Bands). This module is approved for installation into mobile host platforms and must not be co-located or operating in conjunction with any other antenna or transmitter except in accordance with Industry Canada's multi-transmitter guidelines. A minimum 20 cm separation distance between any nearby person and the transmitter or antenna shall be maintained. End users must be provided with transmitter operating conditions for satisfying RF Exposure compliance.

## 8.3 European Union regulatory compliance

Information about regulatory compliance of the European Union for the BMD-341 module is available in the BMD-341 Declaration of Conformity [4].

### 8.3.1 Radio Equipment Directive (RED) 2014/53/EU

The BMD-341 module complies with the essential requirements and other relevant provisions of Radio Equipment Directive (RED) 2014/53/EU.

### 8.3.2 Labeling and user information requirements

The label on the final products which contain a u-blox module must follow CE marking requirements. The “R&TTE Compliance Association Technical Guidance Note 01” provides guidance on final product CE marking.

## 8.4 Australia / New Zealand (RCM)

The BMD-341 has been tested to comply with the AS/NZS 4268:2017, Radio equipment and systems – Short range devices – Limits and methods of measurement. The report may be obtained from your local FAE, and may be used as evidence in obtaining permission to use the Regulatory Compliance Mark (RCM).

Information on registration as a Responsible Party, license and labeling requirements may be found at the following websites:

Australia: <http://www.acma.gov.au/theACMA/radiocommunications-short-range-devices-standard-2004>

New Zealand: <http://www.rsm.govt.nz/compliance>

Only Australian-based and New Zealand-based companies who are registered may be granted permission to use the RCM. An Australian-based or New Zealand-based agent or importer may also register as a Responsible Party to use the RCM on behalf of a company not in Australia or New Zealand.

## 8.5 Bluetooth qualification

The Bluetooth SIG maintains the Bluetooth Specification, and ensures that products are properly tested and comply with the Bluetooth license agreements. Companies that list products with the Bluetooth SIG are required to be members of the SIG and submit the listed fees. Refer to this link for details: <https://www.bluetooth.com/develop-with-bluetooth/qualification-listing>

The BMD-341 Bluetooth low energy module based on Nordic Semiconductor SoCs is listed as a “Tested Component”. This allows an end product based on a u-blox module to inherit the component listings without the need to run all of the tests again. The end product will often inherit several different listings, known as Qualified Design IDs (QDID), and are identified on a “Declaration of Compliance”.

The list of qualified products is found here: <https://launchstudio.bluetooth.com/Listings/Search>

The BMD-341 primarily utilizes the S140 SoftDevice.

## 9 Environmental

### 9.1 RoHS

BMD-341 modules are in compliance with Directive 2011/65/EU, 2015/863/EU of the European Parliament and the Council on the restriction of the use of certain hazardous substances in electrical and electronic equipment.

### 9.2 REACH

BMD-341 modules do not contain the [SVHC \(Substance of Very High Concern\)](#), as defined by Directive EC/1907/2006 Article according to REACH Annex XVII.

### 9.3 California proposition 65 (P65)

This product can expose you to Nickel (metallic), which is known to the State of California to cause cancer. For more information go to [www.P65Warnings.ca.gov](http://www.P65Warnings.ca.gov).

 Warnings are not required where the listed chemical is inaccessible to the average user of the end product.

# 10 Product handling

## 10.1 Packaging

### 10.1.1 Reel packaging for type number BMD-341-A-R-00

Modules are packaged on 330 mm reels loaded with 1000 modules. Each reel is placed in an antistatic bag with a desiccant pack and humidity card and placed in a 340 x 350 x 65 mm box. An antistatic warning and reel label are adhered to the outside of the bag.

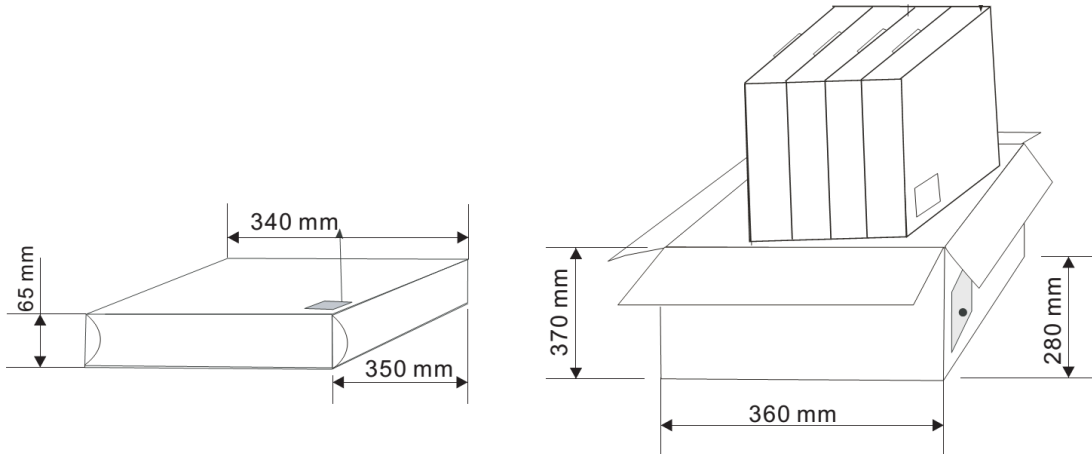
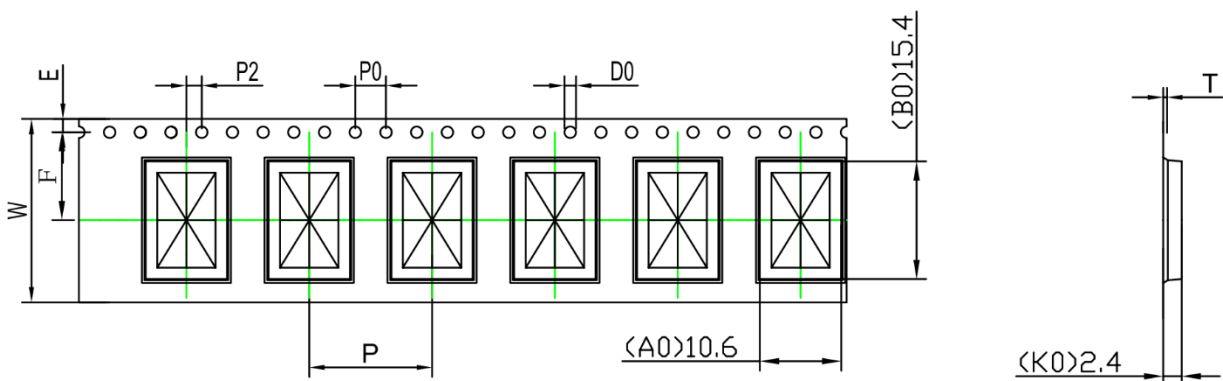

Figure 15 – Reel cartons used for type number BMD-341-A-R-00

### 10.1.2 Reel packaging for type number BMD-341-A-R-10

Modules are packaged on 330 mm reels loaded with 1000 modules. Each reel is placed in an antistatic bag with a desiccant pack and humidity card and placed in a 370x355x56 mm box. See the u-blox Package Information Guide [1] for full specifications on reel dimensions, box sizes and shipping label content. BMD-341-A-R-10 modules use u-blox reel type A3.

### 10.1.3 Carrier tape dimensions for type number BMD-341-A-R-00



ITEM	W	A <sub>0</sub>	B <sub>0</sub>	K <sub>0</sub>	K <sub>1</sub>	P	F	E	D <sub>0</sub>	D <sub>1</sub>	P <sub>0</sub>	P <sub>2</sub>	T
DIM	24.0 <sup>+0.30</sup> <sub>-0.30</sub>	10.60 <sup>+0.10</sup> <sub>-0.10</sub>	15.4 <sup>+0.10</sup> <sub>-0.10</sub>	2.40 <sup>+0.10</sup> <sub>-0.10</sub>	0.00 <sup>+0.00</sup> <sub>-0.00</sub>	16.0 <sup>+0.10</sup> <sub>-0.10</sub>	11.5 <sup>+0.10</sup> <sub>-0.10</sub>	1.75 <sup>+0.10</sup> <sub>-0.10</sub>	1.50 <sup>+0.10</sup> <sub>-0.00</sub>	0.00 <sup>+0.10</sup> <sub>-0.00</sub>	4.00 <sup>+0.10</sup> <sub>-0.10</sub>	2.00 <sup>+0.10</sup> <sub>-0.10</sub>	0.30 <sup>+0.05</sup> <sub>-0.05</sub>
ALTERNATE													

Figure 16 – BMD-341-A-R-00 carrier tape dimensions



### 10.1.4 Carrier tape dimensions for type number BMD-341-A-R-10

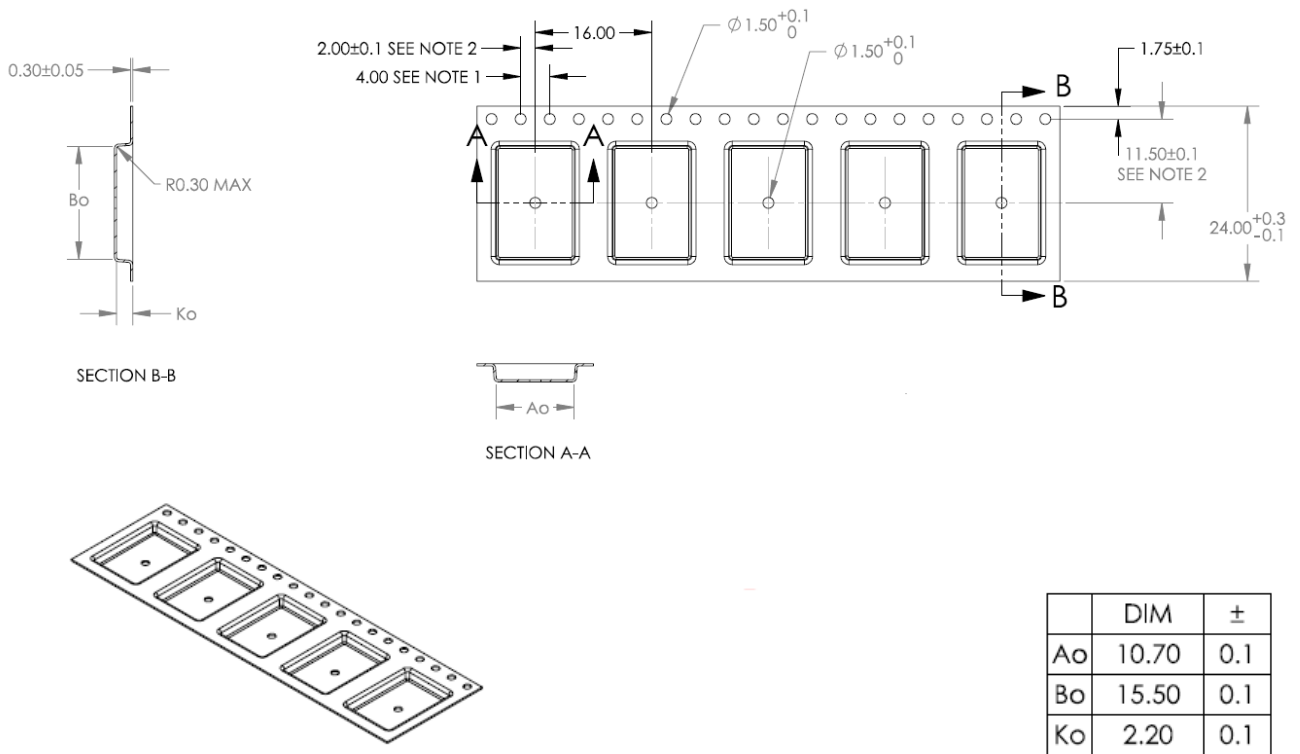

**NOTES:**

1. 10 SPROCKET HOLE PITCH CUMULATIVE TOLERANCE  $\pm 0.2$
2. POCKET POSITION RELATIVE TO SPROCKET HOLE MEASURED AS TRUE POSITION OF POCKET, NOT POCKET HOLE.
3. Ao AND Bo ARE MEASURED ON A PLANE AT A DISTANCE "R" ABOVE THE BOTTOM OF THE POCKET.

**Figure 17: BMD-341-A-R-10 carrier tape dimensions**

## 10.2 Moisture sensitivity level

The BMD-341 is rated for MSL 3, 168-hour floor life after opening.

## 10.3 Reflow soldering

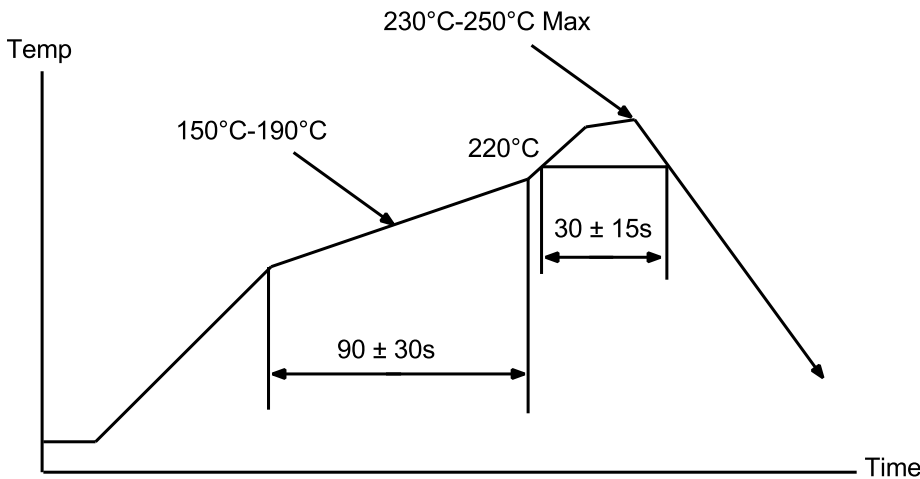

Figure 18: Reflow Profile for lead free solder

## 10.4 ESD precautions

- ⚠ The BMD-341 module contains highly sensitive electronic circuitry and is an Electrostatic Sensitive Device (ESD). Handling the BMD-341 module without proper ESD protection may destroy or damage them permanently.

Proper ESD handling and packaging procedures must be applied throughout the processing, handling and operation of any application that incorporates the BMD-341 module. Failure to observe these recommendations can result in severe damage to the device.

# 11 Ordering information

Ordering Code	Product
BMD-341-A-R	BMD-341 module, Rev A, nRF52840-QIAA, Tape & Reel, 1000 pieces per reel
BMD-341-EVAL	BMD-341 evaluation kit w/ SEGGER J-Link-OB debug probe

**Table 16: Product ordering codes**

## 12 Life support and other high-risk use warnings

This product is neither designed nor intended for use in a life support device or system, nor for use in other fault-intolerant, hazardous, or other environments requiring fail-safe performance, such as any application in which the failure or malfunction of the product could lead directly or indirectly to death, bodily injury, or physical or property damage (collectively, “high-risk environments”).

 u-blox expressly disclaims any express or implied warranty of fitness for use in high-risk environments.

The customer using this product in a high-risk environment agrees to indemnify and defend u-blox from and against any claims and damages arising out of such use.

## Related documents

- [1] u-blox package information guide, [UBX-14001652](#)
- [2] Nordic Semiconductor, [nRF52840 Product Specification](#)
- [3] Nordic Semiconductor, [nRF5 Software Development Kit](#)
- [4] BMD-341 EU Declaration of Conformity, [UBX-19057304](#)

 For product change notifications and regular updates of u-blox documentation, register on our website, [www.u-blox.com](http://www.u-blox.com).

## Revision history

Revision	Date	Name	Comments
0.5	16-Apr-2019		Preliminary release for engineering samples.
1.0	01-Jul-2019		Updated Nordic Semiconductor links Updated HV power output specifications Updated RC Oscillator specifications Updated images throughout
R03	21-Oct-2019		Document converted from Rigado to u-blox style data sheet.
R04	08-Jan-2020	brec	Document/product status updated to Initial Production. Edits for consistency with other BMD-3 modules. Added tolerance to the mechanical drawing (Figure 11)
R05	26-Mar-2020	brec	Added type number BMD-340-A-R-10; Added u-blox logo to Figure 11 to show orientation of label; Added label information for new type number in section 5.3; Added ESD precautions in section 10.4; Changed images to be u-blox branded; Added packaging specification for type number BMD-341-A-R-10 in section 10.1;
R06	27-Apr-2020	brec	Clarified PWM feature, updated block diagram (Figure 1), minor typographical corrections
R07	02-Feb-2021	brec	Updated TX power to include antenna (EIRP), added Canada ISED antenna statement

# Contact

For complete contact information, visit us at [www.u-blox.com](http://www.u-blox.com).

## u-blox Offices

### North, Central and South America

#### u-blox America, Inc.

Phone: +1 703 483 3180  
E-mail: [info\\_us@u-blox.com](mailto:info_us@u-blox.com)

#### Regional Office West Coast:

Phone: +1 408 573 3640  
E-mail: [info\\_us@u-blox.com](mailto:info_us@u-blox.com)

#### Technical Support:

Phone: +1 703 483 3185  
E-mail: [support@u-blox.com](mailto:support@u-blox.com)

### Headquarters

#### Europe, Middle East, Africa

#### u-blox AG

Phone: +41 44 722 74 44  
E-mail: [info@u-blox.com](mailto:info@u-blox.com)  
Support: [support@u-blox.com](mailto:support@u-blox.com)

### Asia, Australia, Pacific

#### u-blox Singapore Pte. Ltd.

Phone: +65 6734 3811  
E-mail: [info\\_ap@u-blox.com](mailto:info_ap@u-blox.com)  
Support: [support\\_ap@u-blox.com](mailto:support_ap@u-blox.com)

#### Regional Office Australia:

Phone: +61 2 8448 2016  
E-mail: [info\\_anz@u-blox.com](mailto:info_anz@u-blox.com)  
Support: [support\\_ap@u-blox.com](mailto:support_ap@u-blox.com)

#### Regional Office China (Beijing):

Phone: +86 10 68 133 545  
E-mail: [info\\_cn@u-blox.com](mailto:info_cn@u-blox.com)  
Support: [support\\_cn@u-blox.com](mailto:support_cn@u-blox.com)

#### Regional Office China (Chongqing):

Phone: +86 23 6815 1588  
E-mail: [info\\_cn@u-blox.com](mailto:info_cn@u-blox.com)  
Support: [support\\_cn@u-blox.com](mailto:support_cn@u-blox.com)

#### Regional Office China (Shanghai):

Phone: +86 21 6090 4832  
E-mail: [info\\_cn@u-blox.com](mailto:info_cn@u-blox.com)  
Support: [support\\_cn@u-blox.com](mailto:support_cn@u-blox.com)

#### Regional Office China (Shenzhen):

Phone: +86 755 8627 1083  
E-mail: [info\\_cn@u-blox.com](mailto:info_cn@u-blox.com)  
Support: [support\\_cn@u-blox.com](mailto:support_cn@u-blox.com)

#### Regional Office India:

Phone: +91 80 405 092 00  
E-mail: [info\\_in@u-blox.com](mailto:info_in@u-blox.com)  
Support: [support\\_in@u-blox.com](mailto:support_in@u-blox.com)

#### Regional Office Japan (Osaka):

Phone: +81 6 6941 3660  
E-mail: [info\\_jp@u-blox.com](mailto:info_jp@u-blox.com)  
Support: [support\\_jp@u-blox.com](mailto:support_jp@u-blox.com)

#### Regional Office Japan (Tokyo):

Phone: +81 3 5775 3850  
E-mail: [info\\_jp@u-blox.com](mailto:info_jp@u-blox.com)  
Support: [support\\_jp@u-blox.com](mailto:support_jp@u-blox.com)

#### Regional Office Korea:

Phone: +82 2 542 0861  
E-mail: [info\\_kr@u-blox.com](mailto:info_kr@u-blox.com)  
Support: [support\\_kr@u-blox.com](mailto:support_kr@u-blox.com)

#### Regional Office Taiwan:

Phone: +886 2 2657 1090  
E-mail: [info\\_tw@u-blox.com](mailto:info_tw@u-blox.com)  
Support: [support\\_tw@u-blox.com](mailto:support_tw@u-blox.com)

## X-ON Electronics

Largest Supplier of Electrical and Electronic Components

*Click to view similar products for [Bluetooth Modules - 802.15.1 category](#):*

*Click to view products by [U-Blox manufacturer](#):*

Other Similar products are found below :

[A2541R24A10GM](#) [CYBLE-212023-10](#) [BM78SPP05NC2-0002AA](#) [BM78SPP05MC2-0002AA](#) [CYW20732S](#) [968EMB0019](#) [E73-2G4M08S1CX](#) [TB-03F-AT\\_Mesh](#) [TB-04](#) [TB-04--AT\\_Mesh](#) [BT3L\(jibu\)](#) [BT5S\(xoft\)](#) [BT5S\(4k43\)](#) [BT5S\(jcyv\)](#) [1327](#) [RN42HID-I/RM](#) [451-00001](#) [BM70BLE01FC2-0B03AA](#) [ACN52832](#) [A2541E24A10GM](#) [RN42-I/RM630](#) [MOTG-BLUETOOTH](#) [ABBTM-2.4GHz-52-T](#) [ABBTM-2.4GHz-T](#) [ABBTM-2.4GHz-T2](#) [ACN52840](#) [AFERO-BL24-01](#) [BLED112](#) [BM62SPKS1MC2-0001AA](#) [BM78SPPS5MC2-0002AA](#) [PX0880/1](#) [BM833F](#) [BT680F](#) [PBA31309V1.00](#) [S LK64](#) [ATSAMB11-MR510CA](#) [BM20SPKS1NBC-0001AA](#) [BM23SPKS1NB9-0B02AA](#) [BM70BLE01FC2-0B04AA](#) [BM70BLES1FC2-0B04AA](#) [BM77SPP03MC2-0008AA](#) [BM77SPPS3MC2-0007AA](#) [BM78SPPS5NC2-0002AA](#) [DM164146](#) [RN42-I/RM615](#) [RN42N-I/RM](#) [RN42NU-IRM](#) [RN42XVP-I/RM](#) [RN4678-V/RM113](#) [RN4871U-V/RM118](#) [ENW-89820A3KF](#)