

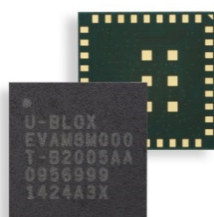

EVA-M8

u-blox M8 concurrent GNSS modules

Data Sheet



Abstract

Technical data sheet describing the EVA-M8 module family which provides concurrent reception of up to 3 GNSS (GPS, Galileo, GLONASS, BeiDou). EVA-M8 is a highly integrated module in a 7x7 mm package.

Document Information

Title	EVA-M8	
Subtitle	u-blox M8 concurrent GNSS modules	
Document type	Data Sheet	
Document number	UBX-16014189	
Revision and date	R05	10-May-2019
Document status	Production Information	

Product status	Corresponding content status	
In Development / Prototype	Objective Specification	Target values. Revised and supplementary data will be published later.
Engineering Sample	Advance Information	Data based on early testing. Revised and supplementary data will be published later.
Initial Production	Early Production Information	Data from product verification. Revised and supplementary data may be published later.
Mass Production / End of Life	Production Information	Document contains the final product specification.

This document applies to the following products:

Product name	Type number	ROM/FLASH version	PCN / IN reference
EVA-M8M	EVA-M8M-0-10	ROM SPG 3.01 / Flash FW SPG 3.01	UBX-16012546
EVA-M8M	EVA-M8M-1-10	ROM SPG 3.01 / Flash FW SPG 3.01	UBX-16012546
EVA-M8Q	EVA-M8Q-0-10	ROM SPG 3.01 / Flash FW SPG 3.01	N/A

u-blox or third parties may hold intellectual property rights in the products, names, logos and designs included in this document. Copying, reproduction, modification or disclosure to third parties of this document or any part thereof is only permitted with the express written permission of u-blox.

The information contained herein is provided "as is" and u-blox assumes no liability for its use. No warranty, either express or implied, is given, including but not limited to, with respect to the accuracy, correctness, reliability and fitness for a particular purpose of the information. This document may be revised by u-blox at any time without notice. For the most recent documents, visit www.u-blox.com.

Copyright © u-blox AG.

Contents

Document Information	2
Contents	3
1 Functional description	6
1.1 Overview	6
1.2 Product features	6
1.3 Performance.....	7
1.4 Block diagram	8
1.5 Supported GNSS constellations	8
1.5.1 GPS	9
1.5.2 GLONASS	9
1.5.3 BeiDou	9
1.5.4 Galileo	9
1.6 Assisted GNSS (A-GNSS).....	10
1.6.1 AssistNow™ Online.....	10
1.6.2 AssistNow™ Offline.....	10
1.6.3 AssistNow™ Autonomous	10
1.7 Augmentation Systems	11
1.7.1 Satellite-Based Augmentation System (SBAS)	11
1.7.2 QZSS	11
1.7.3 IMES	11
1.7.4 Differential GPS (D-GPS).....	11
1.8 Broadcast navigation data and satellite signal measurement	11
1.9 Odometer	12
1.10 Data logging	12
1.11 Geofencing.....	12
1.12 Message Integrity Protection.....	12
1.12.1 Spoofing detection	12
1.13 EXTINT: External interrupt.....	12
1.13.1 Pin control	13
1.13.2 Aiding	13
1.14 TIMEPULSE	13
1.15 Protocols and interfaces	13
1.16 Interfaces.....	13
1.16.1 UART	13
1.16.2 USB	13
1.16.3 SPI	14
1.16.4 Display Data Channel (DDC)	14
1.16.5 Serial Quad Interface (SQI)	14
1.16.6 Interface selection (D_SEL)	14
1.17 Configurable Input Output pins	14

1.18 Safe Boot Mode	15
1.19 System reset.....	15
1.20 Clock generation.....	15
1.20.1 Oscillators	15
1.20.2 Real-Time Clock (RTC).....	15
1.21 Power Management	15
1.21.1 DC-DC converter	16
1.21.2 Power Mode Setup.....	16
1.21.3 Continuous Mode.....	16
1.21.4 Power Save Mode.....	16
1.22 Antenna.....	17
1.22.1 Active antenna control (ANT_OFF).....	17
1.22.2 Active Antenna supervisor and short circuit detection.....	17
2 Pin definition	18
2.1 Pin assignment.....	18
2.2 Pin name changes.....	20
3 Electrical specification	21
3.1 Absolute maximum rating.....	21
3.2 Operating conditions.....	21
3.2.1 DC electrical characteristic	22
3.2.2 Baseband parameters	23
3.3 Indicative power requirements.....	23
3.4 SPI timing diagrams	24
3.4.1 Timing recommendations.....	24
3.5 DCC timing diagrams	24
4 Mechanical specification	25
5 Reliability tests and approvals.....	26
5.1 Reliability tests.....	26
5.2 Approvals.....	26
6 Product handling.....	27
6.1 Packaging	27
6.1.1 Reels	27
6.1.2 Tapes.....	27
6.2 Shipment, storage and handling	28
6.3 Moisture Sensitivity Levels.....	28
6.4 Reflow soldering	28
6.5 ESD handling precautions.....	28
7 Default messages	29
8 Labeling and ordering information	30
8.1 Product labeling.....	30
8.2 Explanation of product codes.....	30
8.3 Ordering codes.....	30

Appendix	31
A Glossary	31
Related documents	32
Revision history	32
Contact.....	33

1 Functional description

1.1 Overview

The EVA-M8M/Q GNSS modules feature the exceptional performance of the u-blox M8 concurrent positioning engine (receiving GPS, GLONASS, Galileo, BeiDou, QZSS and SBAS signals). The EVA-M8M/Q modules deliver high sensitivity and minimal acquisition times in the ultra-compact EVA form factor.

The EVA-M8M/Q series is an ideal solution for cost and space-sensitive applications. It is easy to design in, only requiring an external GNSS antenna in most applications. The layout of the EVA-M8M/Q series is especially designed to ease the customer's design and limit near field interferences since RF and digital domains are kept separate.

The EVA-M8M series uses a crystal oscillator for lower system costs, while EVA-M8Q with TCXO provides best performance. Like other u-blox GNSS modules, the EVA-M8M/Q modules use components selected for functioning reliably in the field over the full operating temperature range. In addition, EVA-M8M/Q provides an SPI interface for optional external FLASH, for future firmware upgrades and improved A-GNSS performance. The EVA-M8M/Q modules support message integrity protection, geo-fencing, and spoofing detection.

With a dual-frequency RF front-end, the u-blox M8 concurrent GNSS engine is able to intelligently use the highest number of visible satellites from three GNSS (GPS and Galileo, together with GLONASS or BeiDou) systems for reliable positioning.

The EVA-M8M/Q can be easily integrated in manufacturing, thanks to the QFN-like package. The modules are available in 500 pieces/reel, ideal for small production batches. The modules combine a high level of integration capability with flexible connectivity options in a miniature package. This makes the EVA-M8M/Q modules perfectly suited for small size and cost-sensitive industrial and wearable devices. The DDC (I2C compliant) interface provides connectivity and enables synergies with u-blox cellular modules.

The EVA-M8M/Q modules are qualified as stipulated in the JESD47 standard.

1.2 Product features

Model	Category	GNSS				Supply	Interfaces				Features						Grade							
		GPS / QZSS	GLONASS	Galileo	BeiDou		Number of concurrent GNSS	1.65 V – 3.6 V	2.7 V – 3.6 V	UART	USB	SPI	DDC (I ² C compliant)	Programmable (flash)	Data logging	Additional SAW	Additional LNA	RTC crystal	Oscillator	Built-in antenna	Built-in antenna supply and supervisor	Timepulse	Standard	Professional
EVA-M8M	●	●	●	●	●	3	●		●	●	●	●	E	E			◆	C			1	●		
EVA-M8Q	●	●	●	●	●	3	●		●	●	●	●	E	E			◆	T			1	●		

◆ = Optional, or requires external components

E = External flash required

C = Crystal / T = TCXO

1.3 Performance

Parameter	Specification					
Receiver type	72-channel u-blox M8 engine GPS/QZSS L1C/A, GLONASS L1OF, BeiDou B1I, Galileo E1B/C, SBAS L1C/A: WAAS, EGNOS, MSAS, GAGAN					
Accuracy of time pulse signal	RMS	30 ns				
	99%	60 ns				
Frequency of time pulse signal	0.25 Hz...10 MHz (configurable)					
Operational limits ¹	Dynamics	≤ 4 g				
	Altitude	50,000 m				
	Velocity	500 m/s				
Velocity accuracy ²	0.05 m/s					
Heading accuracy ²	0.3 degrees					
GNSS	GPS & GLONASS	GPS	GLONASS	BeiDou	Galileo	
Horizontal position accuracy ³	2.5 m	2.5 m	4.0 m	3.0 m	TBC ⁴	
Max navigation update rate	ROM	10 Hz	18 Hz	18 Hz	18 Hz	18 Hz
	FLASH	5 Hz	10 Hz	10 Hz	10 Hz	10 Hz
EVA-M8Q						
Time-To-First-Fix ⁵	Cold Start	26 s	29 s	30 s	34 s	45 s
	Hot Start	1 s	1 s	1 s	1 s	1 s
	Aided Start ⁶	2 s	2 s	2 s	3 s	7 s
Sensitivity ⁷	Tracking & Navigation	-167 dBm	-166 dBm	-166 dBm	-160 dBm	-159 dBm
	Reacquisition	-160 dBm	-160 dBm	-156 dBm	-157 dBm	-153 dBm
	Cold Start	-148 dBm	-148 dBm	-145 dBm	-143 dBm	-138 dBm
	Hot Start	-157 dBm	-157 dBm	-156 dBm	-155 dBm	-151 dBm
EVA-M8M						
Time-To-First-Fix ⁵	Cold Start	26 s	30 s	31 s	39 s	57 s
	Hot start	1 s	1 s	1 s	1 s	1 s
	Aided starts ⁶	3 s	3 s	3 s	7 s	7 s
Sensitivity ⁷	Tracking & Navigation	-164 dBm	-164 dBm	-163 dBm	-160 dBm	-154 dBm
	Reacquisition	-160 dBm	-159 dBm	-156 dBm	-155 dBm	-152 dBm
	Cold start	-148 dBm	-147 dBm	-145 dBm	-143 dBm	-133 dBm
	Hot start	-157 dBm	-156 dBm	-155 dBm	-155 dBm	-151 dBm

Table 1: EVA-M8M/Q performance in different GNSS modes (default: concurrent reception of GPS & GLONASS incl. QZSS, SBAS)

¹ Assuming Airborne < 4 g platform

² 50% @ 30 m/s

³ CEP, 50%, 24 hours static, -130 dBm, > 6 SVs

⁴ To be confirmed when Galileo reaches full operational capability

⁵ All satellites at -130 dBm, except Galileo at -127 dBm

⁶ Dependent on aiding data connection speed and latency

⁷ Demonstrated with a good external LNA

1.4 Block diagram

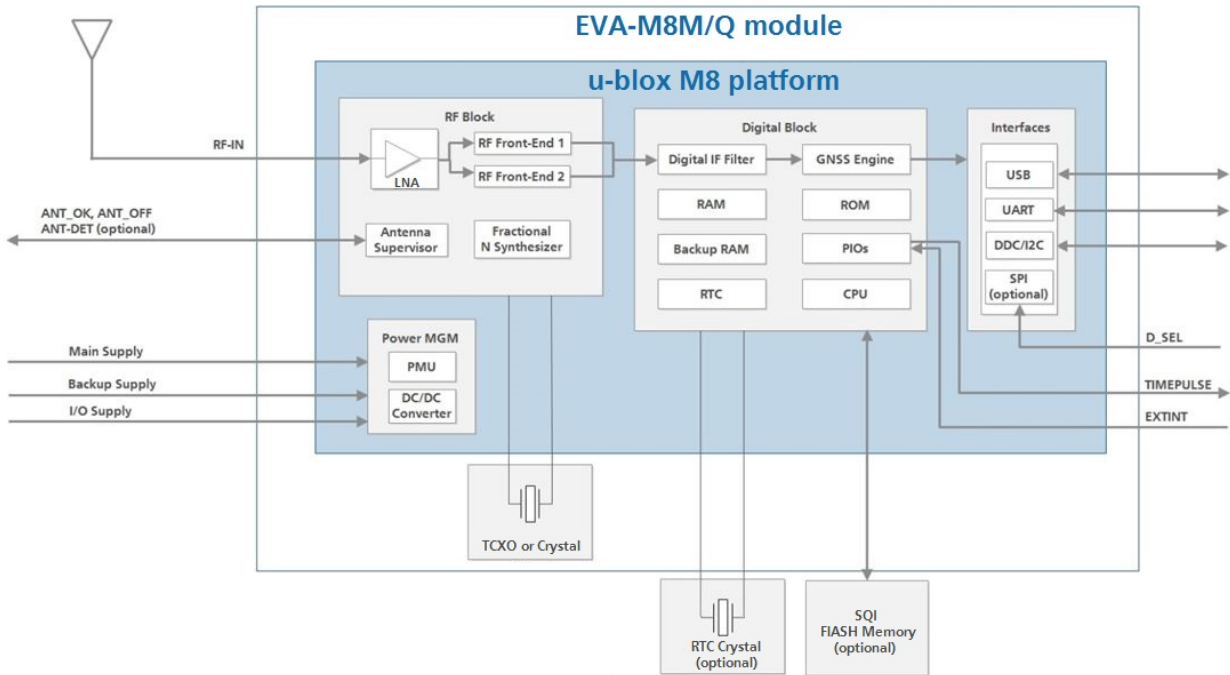

Figure 1: EVA-M8M/Q block diagram

1.5 Supported GNSS constellations

The EVA-M8M/Q modules are concurrent GNSS receivers and can receive and track multiple GNSS systems (GPS, GLONASS, Galileo, BeiDou and QZSS signals). Owing to the dual-frequency RF front-end architecture, either GLONASS or BeiDou can be processed concurrently with GPS and Galileo signals, providing reception of three GNSS systems.



The EVA-M8M series has two variants: EVA-M8M-0 (default: concurrent GPS/QZSS/SBAS and GLONASS) and EVA-M8M-1 (default: concurrent GPS/QZSS/SBAS and BeiDou).

If power consumption is a key factor, then the EVA-M8M/Q should be configured for single GNSS operation using GPS or GLONASS or BeiDou and disabling QZSS and SBAS.

The module can be configured to receive any single GNSS constellation or any of the set of permissible combinations shown below

GPS	Galileo	GLONASS	BeiDou
•	•	–	–
•	•	•	–
•	•	–	•
•	–	•	–
•	–	–	•
–	•	•	–
–	•	–	•
–	–	•	•

Table 2: Permissible GNSS combinations (• = enabled)

-  The augmentation systems: SBAS and QZSS can be enabled only if GPS operation is configured. QZSS should be enabled whenever GPS operation is configured.
-  Galileo is not enabled as the default configuration.
-  When the EVA-M8M-1 variant is attached with an external SPI flash without running flash firmware, the default concurrent reception of GPS/QZSS/SBAS and BeiDou remains unchanged. If the flash is also used for execution of firmware update, the default reception will be reset to GPS/QZSS/SBAS and GLONASS. See the EVA-8M / EVA-M8 Hardware Integration Manual [1] for more information on how to preset default concurrent reception of GPS/QZSS/SBAS and BeiDou.

1.5.1 GPS

The EVA-M8M/Q positioning modules are designed to receive and track the L1C/A signals provided at 1575.42 MHz by the Global Positioning System (GPS).

1.5.2 GLONASS

The EVA-M8M/Q modules can receive and process the GLONASS satellite system as an alternative to the US-based Global Positioning System (GPS). The u-blox EVA-M8M/Q series is designed to receive and track the L1OF signals GLONASS provided at 1602 MHz + $k \cdot 562.5$ kHz, where k is the satellite's frequency channel number ($k = -7, \dots, 5, 6$). The ability to receive and track GLONASS L1OF satellite signals allows design of GLONASS receivers where required by regulations.



To take advantage of GPS and GLONASS, dedicated hardware preparation must be made during the design-in phase. See the EVA-8M / EVA-M8 Hardware Integration Manual [1] for u-blox design recommendations.

1.5.3 BeiDou

The EVA-M8M/Q modules can receive and process the B1I signals broadcast at 1561.098 MHz from the BeiDou Navigation Satellite System. The ability to receive and track BeiDou B1 satellite signals in conjunction with another constellation results in higher coverage, improved reliability and better accuracy. Currently, BeiDou is not fully operational globally and provides Chinese regional coverage only. Global coverage is scheduled for 2020.

1.5.4 Galileo

The EVA-M8M/Q positioning modules can receive and track the E1-B/C signals centered on the GPS L1 frequency band. GPS and Galileo signals can be processed concurrently together with BeiDou or GLONASS signals, enhancing coverage, reliability and accuracy. The SAR return link message (RLM) parameters for both short and long versions are decoded by the receiver and made available to users via UBX proprietary messages.

-  Galileo has been implemented according to ICD release 1.3 (December 2016). Since the Galileo satellite system has only recently reached Initial Services (IS) and not yet at Full Operational Capability (FOC), changes to the Galileo signal specification (OS SIS ICD) remain theoretically possible. u-blox therefore recommends to use Flash memory in designs utilizing Galileo signals in order to allow for a firmware update in the unlikely event of a change to the Galileo signal specification (OS SIS ICD).
-  Galileo reception is by default disabled, but can be enabled by sending a configuration message (UBX-CFG-GNSS) to the receiver. See the u-blox 8 / u-blox M8 Receiver Description Including Protocol Specification [2] for more information.

1.6 Assisted GNSS (A-GNSS)

Supply of GNSS receiver assistance information, such as ephemeris, almanac, rough user position and time, will reduce the time to first fix significantly and improve acquisition sensitivity. EVA-M8M and EVA-M8Q modules support the u-blox AssistNow Online and AssistNow Offline A-GNSS services, support AssistNow Autonomous, and are OMA SUPL compliant.

1.6.1 AssistNow™ Online

With AssistNow Online, an Internet connected host downloads assistance data from the u-blox AssistNow Online service to the receiver at system start-up. The Multi-GNSS Assistance (MGA) service is an HTTP protocol based network operator independent service.

Supplying assistance information, such as ephemeris, almanac, a rough last position and time, can reduce the time to first fix significantly and improve acquisition sensitivity.

 The AssistNow Online service provides data for GPS, GLONASS, BeiDou, Galileo and QZSS.

1.6.2 AssistNow™ Offline

With the AssistNow Offline service, users can download long-term orbit data over the Internet at their convenience. The orbit data can be stored in the GNSS receiver's SQI flash memory or alternatively within the memory of the application processor. The function requires no connectivity at system start-up, enabling a position fix within seconds, even when no network is available. AssistNow Offline offers augmentation for up to 35 days.

 AssistNow Offline service provides data for GPS and GLONASS only, BeiDou and Galileo are not currently supported

1.6.3 AssistNow™ Autonomous

AssistNow Autonomous provides aiding information without the need for a host or external network connection. Based on previous broadcast satellite ephemeris data downloaded to and stored by the GNSS receiver, AssistNow Autonomous automatically generates accurate predictions of satellite orbital data ("AssistNow Autonomous data") that is usable for future GNSS position fixes. The concept capitalizes on the periodic nature of GNSS satellites; by capturing strategic ephemeris data at specific times of the day, the receiver can predict accurate satellite ephemeris for up to six days after initial reception.

The benefits of the u-blox AssistNow Autonomous feature are:

- Faster fix in situations where GNSS satellite signals are weak
- No connectivity required
- Compatible with AssistNow Online (can work stand-alone, or in tandem with the AssistNow Online service)
- No integration effort; calculations are done in the background, transparent to the user.

 For best AssistNow Autonomous performance and data storage, the use of an SQI flash memory is recommended for EVA-M8M/Q modules, otherwise only GPS satellites are used and the prediction time decreases to three days.

1.7 Augmentation Systems

1.7.1 Satellite-Based Augmentation System (SBAS)

u-blox EVA-M8M/Q positioning modules support SBAS. These systems supplement GNSS data with additional regional or wide area GPS augmentation data. The system broadcasts range correction and integrity information via satellite which can be used by GNSS receivers to improve resulting precision. SBAS satellites can be used as additional satellites for ranging (navigation), further enhancing availability. The following SBAS types are supported: GAGAN, WAAS, EGNOS and MSAS.

 For more details, see the u-blox 8 / u-blox M8 Receiver Description Including Protocol Specification [2].

1.7.2 QZSS

The Quasi-Zenith Satellite System (QZSS) is a regional navigation satellite system that transmits additional GPS L1 C/A signals for the Pacific region covering Japan and Australia. EVA-M8M/Q positioning module is able to receive and track these signals concurrently with GPS signals, resulting in better availability especially under challenging signal conditions, e.g. in urban canyons. The L1-SAIF signal provided by QZSS can be enabled for reception via a GNSS configuration message

1.7.3 IMES

The Japanese Indoor Messaging System (IMES) system is used for indoor position reporting using low-power transmitters which broadcast a GPS-like signal. EVA-M8M/Q module can be configured to receive and demodulate the signal to provide an in-door location estimate.

 This service is authorized and available only in Japan.

 IMES reception is disabled by default

1.7.4 Differential GPS (D-GPS)

u-blox EVA-M8M/Q modules support Differential-GPS data according to RTCM 10402.3 [4]. The use of Differential-GPS data improves GPS position accuracy. The RTCM implementation supports the following RTCM 2.3 messages:

Message Type	Description
1	Differential GPS Corrections
2	Delta Differential GPS Corrections
3	GPS Reference Station Parameters
9	GPS Partial Correction Set

Table 3: Supported RTCM 2.3 messages

 RTCM correction cannot be used together with SBAS.

 For more information, see the u-blox 8 / u-blox M8 Receiver Description Including Protocol Specification [2].

1.8 Broadcast navigation data and satellite signal measurement

The EVA-M8M/Q can output all the GNSS broadcast data upon reception from tracked satellites. This includes all the supported GNSS signals plus the augmentation services SBAS, QZSS and IMES. The receiver also makes available the tracked satellite signal information, i.e. raw code phase and Doppler measurements in a form aligned to the Radio Resource LCS Protocol (RRLP) [6]. For more information, see the u-blox 8 / u-blox M8 Receiver Description Including Protocol Specification [2].

1.9 Odometer

The odometer function provides information on travelled ground distance (in meters) based on the position and Doppler-based velocity output from the navigation solution. For each computed distance since the last odometer reset, the odometer estimates a 1-sigma accuracy value. The total cumulative ground distance is maintained and saved in the BBR memory.

 The odometer feature is disabled by default. For more information, see the u-blox 8 / u-blox M8 Receiver Description Including Protocol Specification [2].

1.10 Data logging

The EVA-M8M/Q modules can be used in data logging applications if external flash is use. The data logging feature enables continuous storage of position, velocity and time information to an onboard SQL flash memory (at least 16 Mbit).It can also log the distance from the odometer. The information can be downloaded from the receiver later for further analysis or for conversion to a mapping tool.

 For more information, see the u-blox 8 / u-blox M8 Receiver Description Including Protocol Specification [2].

1.11 Geofencing

The u-blox EVA-M8M/Q modules support up to four circular Geofencing areas defined on the earth's surface using a 2D model. Geofencing is active when at least one geofence is defined, the current status can be found by polling the receiver. A GPIO pin can be nominated to indicate status to e.g. wake up a host on activation.

1.12 Message Integrity Protection

The EVA-M8M/Q modules provide a function to detect third party interference with the UBX message steam sent from receiver to host. The security mechanism 'signs' nominated messages via a subsequent UBX message. This message signature is then compared with one generated by the host to determine if the message data has been altered. The signature algorithm seed can use one fixed secret ID key set by eFuse in production and a dynamic ID key set by the host, enabling users to detect 'man-in-the-middle' style attacks.

1.12.1 Spoofing detection

Spoofing is a process whereby a malicious third party tries to control the reported position via a 'fake' GNSS broadcast signal. This may result in the form of reporting incorrect position, velocity or time. To combat against this, the EVA-M8M/Q modules include spoofing detection measures to alert the host when signals appear to be suspicious. The receiver combines a number of checks on the received signals looking for inconsistencies across several parameters.

 This feature does not guarantee to detect all spoofing attacks.

1.13 EXTINT: External interrupt

EXTINT is an external interrupt pin with fixed input voltage thresholds with respect to **VCC_IO**. It can be used for control of the receiver or for aiding.

For more information about how to implement and configure these features, see the u-blox 8 / u-blox M8 Receiver Description including Protocol Specification [2] and the EVA-8M / EVA-M8 Hardware Integration Manual [1].

1.13.1 Pin control

The pin control feature allows overriding the automatic active/inactive cycle of Power Save Mode. The state of the receiver can be controlled through the **EXTINT** pin.

The receiver can also be forced OFF using **EXTINT** when Power Save Mode is not active.

1.13.2 Aiding

The **EXTINT** pin can be used to supply time or frequency aiding data to the receiver.

For time aiding, the time can be supplied using hardware time synchronization where an accurate time pulse is connected to the **EXTINT** pin.

Frequency aiding can be implemented by connecting a periodic rectangular signal with a frequency up to 500 kHz and arbitrary duty cycle (low/high phase duration must not be shorter than 50 ns) to the **EXTINT** pin, and providing the applied frequency value to the receiver using UBX messages.

1.14 TIMEPULSE

A configurable time pulse signal is available with u-blox EVA-M8M/Q series modules.

The TIMEPULSE output generates pulse trains synchronized with GPS or UTC time grid with intervals configurable over a wide frequency range. Thus it may be used as a low frequency time synchronization pulse or as a high frequency reference signal.

By default the time pulse signal is configured to 1 pulse per second. For more information, see the u-blox 8 / u-blox M8 Receiver Description including Protocol Specification [2].

1.15 Protocols and interfaces

Protocol	Type
NMEA 0183, version 4.0 (V2.3 or V4.1 configurable)	Input/output, ASCII,
UBX	Input/output, binary, u-blox proprietary
RTCM	Input, messages 1, 2, 3, 9

Table 4: Available Protocols

All protocols are available on UART, USB, DDC (I²C compliant) and SPI. For specification of the various protocols, see the u-blox 8 / u-blox M8 Receiver Description Including Protocol Specification [2].

1.16 Interfaces

A number of interfaces are provided either for data communication or memory access. The embedded firmware uses these interfaces according to their respective protocol specifications.

1.16.1 UART

The EVA-M8M/Q modules make use of a UART interface, which can be used for communication to a host. It supports configurable baud rates. For supported transfer rates, see the u-blox 8 / u-blox M8 Receiver Description Including Protocol Specification [2].

 Designs must allow access to the UART and the **SAFEBOOT_N** pin for future service, updates and reconfiguration.

1.16.2 USB

A USB interface, which is compatible to USB version 2.0 FS (Full Speed, 12 Mbit/s), can be used for communication as an alternative to the UART. The pull-up resistor on pin **USB_DP** is integrated to signal a full-speed device to the host. The **VDD_USB** pin supplies the USB interface. The u-blox USB (CDC-ACM) driver supports Windows Vista plus Windows 7 and 8 operating systems. A separate

driver (CDC-ACM) is not required for Windows 10 which has a built-in USB-serial driver. However, plugging initially into an internet connected Windows 10 PC, will down-load the u-blox combined sensor and VCP driver package.

USB drivers can be down-loaded from the u-blox web site, www.u-blox.com.

1.16.3 SPI

The SPI interface is designed to allow communication to a host CPU. The interface can be operated in slave mode only. The maximum transfer rate using SPI is 125 kB/s and the maximum SPI clock frequency is 5.5 MHz. Note that SPI is not available in the default configuration, because its pins are shared with the UART and DDC interfaces. The SPI interface can be enabled by connecting **D_SEL** to ground (see section 1.17.6). In this case the DDC interface for data communication is not available.

1.16.4 Display Data Channel (DDC)

An I²C compliant DDC interface is available for communication with an external host CPU. The interface can be operated in slave mode only. The DDC protocol and electrical interface are fully compatible with Fast-Mode of the I²C industry standard. Since the maximum SCL clock frequency is 400 kHz, thus the maximum transfer rate is 400 kbit/s.

The DDC interface is I²C Fast Mode compliant. For timing parameters consult the I²C standard.

 The maximum bit rate is 400 kbit/s. The interface stretches the clock when slowed down while serving interrupts, so real bit rates may be slightly lower.

1.16.5 Serial Quad Interface (SQI)

An SQI is available in EVA-M8M/Q series for connecting the modules with an optional external flash memory. The flash memory is required for firmware updates and for data logging. In addition, it can be used to store configurations and to save AssistNow Offline and AssistNow Autonomous data.

 For more information, see the EVA-8M / EVA-M8 Hardware Integration Manual [1].

1.16.6 Interface selection (D_SEL)

At startup the **D_SEL** pin determines which data interfaces are used for communication. If **D_SEL** is set to logical “1” or is not connected, UART and DDC become available. If **D_SEL** is set to logical “0”, i.e. connected to GND, the EVA-M8M/Q modules can communicate to a host via SPI.

Pin #	(D_SEL)=“1” (left open)	(D_SEL)=“0” (connected to GND)
16	UART TXD	SPI MISO
15	UART RXD	SPI MOSI
29	DDC SCL	SPI CLK
30	DDC SDA	SPI CS_N

Table 5: Data interface selection by D_SEL

1.17 Configurable Input Output pins

Configuration settings can be modified for several Input/Output pins with either UBX configuration messages or pin selection. This flexible configuration options allow the receivers to be optimally configured for specific applications requirements. The modified settings remain either permanent or effective until power-down or reset depending on the case. Customer can activate or remap the following pins on EVA-M8M/Q series:

1. Selection of either DDC or UART TXD/RXD pins interface using **D_SEL** pin. See section 1.17.6.
2. Selection of antenna supervision pins. See section 1.23.
3. Selection of external interrupt pins. See section 1.14.

4. Configuration of Timepulse. See section [1.15](#).

 For more information, see the EVA-8M / EVA-M8 Hardware Integration Manual [\[1\]](#).

1.18 Safe Boot Mode

If Pin33 (**SAFEBOOT_N**) is set to logical “0” at startup, the EVA-M8M/Q receivers enter Safe Boot Mode. In this mode the receiver does not calculate positioning data, but is in a defined state that allows such actions as programming the flash memory in production, or recovering a corrupted flash memory.

 For more information about Safe Boot Mode, see the EVA-8M / EVA-M8 Hardware Integration Manual [\[1\]](#).

1.19 System reset

The EVA-M8M/Q series provides a **RESET_N** pin to reset the system and Real-Time Clock (RTC). The **RESET_N** pin should be only used in critical situations to recover the system.

1.20 Clock generation

1.20.1 Oscillators

The EVA-M8 GNSS modules are available in TCXO and crystal versions. EVA-M8M uses a 26 MHz crystal oscillator for lower system costs, while EVA-M8Q with TCXO provides best performance. Like other u-blox GNSS modules, the EVA-M8M/Q modules use components selected for functioning reliably in the field over the full operating temperature range.

1.20.2 Real-Time Clock (RTC)

The use of the RTC Clock may be optionally used to maintain time in the event of power failure at **VCC_IO**. The RTC is required for hot start, warm start, AssistNow Autonomous, AssistNow Offline and some Power Save Mode operations.

The use of the RTC is optional. The time information can be generated in one of these ways:

- by connecting to an external RTC crystal (for lower battery current – default mode)
- by sharing from another RTC oscillator used within the application (for lowest system costs and smallest size)

If the main supply voltage fails and a battery is connected to **V_BCKP**, parts of the baseband section switch off, but the RTC still runs, providing a timing reference for the receiver. This operating mode is called Hardware Backup Mode, which enables all relevant data to be saved in the backup RAM to later allow a hot or warm start.

 With EVA-M8M, RTC clock can be derived from the onboard 26 MHz crystal oscillator. For more information about crystal operation and configuration, see the EVA-8M / EVA-M8 Hardware Integration Manual [\[1\]](#).

 Deriving RTC clock from internal oscillator is not available on EVA-M8Q.

 If neither backup RAM nor RTC are used, the backup battery is not needed and **V_BCKP** should be connected to **VCC_IO**.

1.21 Power Management

u-blox M8 technology offers a power-optimized architecture with built-in autonomous power saving functions to minimize power consumption at any given time. Furthermore, the receiver can be used in two operating modes: Continuous mode for best performance or Power Save Mode for optimized

power consumption. In addition, a high efficiency DC/DC converter is integrated to allow low power consumption even for higher main supply voltages.

1.21.1 DC-DC converter

EVA-M8M/Q modules integrate a DC-DC converter, allowing reduced power consumption by up to 50%, especially when using a main supply voltage above 2.5 V.

 For more information, see the EVA-8M / EVA-M8 Hardware Integration Manual [\[1\]](#).

1.21.2 Power Mode Setup

The EVA-M8M/Q modules can be configured to run in either continuous or a choice of Power Save mode configurations. A template of power mode settings can be used to easily select typical power mode setups to cover the majority of users' requirements.

For specific power saving applications, the user has the option to fully configure via the power save mode configuration. More information, see section [1.22.4](#).

The EVA-M8M/Q module's power mode setup offers a choice of continuous operation and preset Power Save Mode Configurations.

- Continuous (default) mode for best GNSS performance vs power consumption
- Continuous with no compromise in power consumption
- A 1 Hz cyclic tracking mode for aggressive power reduction
- Choice of 2 or 4 Hz⁸ cyclic tracking modes for typical wearable applications
- ON/OFF interval mode

1.21.3 Continuous Mode

Continuous Mode uses the acquisition engine at full performance resulting in the shortest possible TTFF and the highest sensitivity. It searches for all possible satellites until the Almanac is completely downloaded. The receiver then switches to the tracking engine to lower power consumption.

Thus, a lower tracking current consumption level will be achieved when:

- A valid GNSS position is obtained
- The entire Almanac has been downloaded
- The Ephemeris of each satellite in view is valid

1.21.4 Power Save Mode

For specific power saving applications outside the typical preset power mode setups, users can configure a tailored Power Save Mode.

Power Save Mode provides two dedicated methods, ON/OFF and Cyclic tracking, that reduce average current consumption in different ways to match the needs of the specific application. These operations can be set by using a specific UBX message.

 For more information about power management strategies, see the u-blox 8 / u-blox M8 Receiver Description Including Protocol Specification [\[2\]](#).

⁸ Single GNSS constellation configuration only

1.22 Antenna

The EVA-M8M/Q modules are designed for use with passive⁹ and active¹⁰ antennas.

Parameter	Specification	
Antenna Type	Passive and active antenna	EVA-M8M with passive antenna, an external LNA is mandatory . EVA-M8Q with passive antenna, an external LNA is recommended .
Active Antenna Recommendations	Minimum gain	15 dB (to compensate signal loss in RF cable)
	Maximum gain	50 dB
	Maximum noise figure	2 dB

Table 6: Antenna recommendations and specifications for EVA-M8M/Q modules

1.22.1 Active antenna control (ANT_OFF)

The **ANT_OFF** Pin can be used to turn on and off an external LNA or an active antenna. This reduces power consumption in Power Save Mode (Backup mode). This pin is available in EVA-M8M/Q modules.

 **ANT_OFF** pin polarity can be changed. For more information about active antenna control, see the EVA-8M / EVA-M8 Hardware Integration Manual [1].

1.22.2 Active Antenna supervisor and short circuit detection

An antenna supervisor is available with the EVA-M8M/Q modules and requires external components. The antenna supervisor enables the receiver to detect short circuits at the active antenna using the **ANT_OFF** and **ANT_OK** pins (activated per default) and to shut down the voltage bias immediately. The antenna supervisor can be extended to also detect condition of open circuit by activating the **ANT_DET** pin and including external components for antenna open circuit detection. UBX and NMEA messages are provided to report the condition of the antenna supply. Open circuit detection can also be supported.

 For more information, see the EVA-8M / EVA-M8 Hardware Integration Manual [1].

⁹ For integrating an EVA-M8 GNSS series module with a Cellular product, see the EVA-8M / EVA-M8 Hardware Integration Manual [1].

¹⁰ For information on using an active antenna with an EVA-M8 module, see the EVA-8M / EVA-M8M Hardware Integration Manual [1].

2 Pin definition

2.1 Pin assignment

This section shows the pin assignments. Most PIOs are configurable and have shared functions. Use special care when designing with these pins since the overall function of the device can be affected.

The default configuration of the PIOs is listed in [Table 7](#) below.

For more information, see the EVA-8M / EVA-M8 Hardware Integration Manual [\[1\]](#).

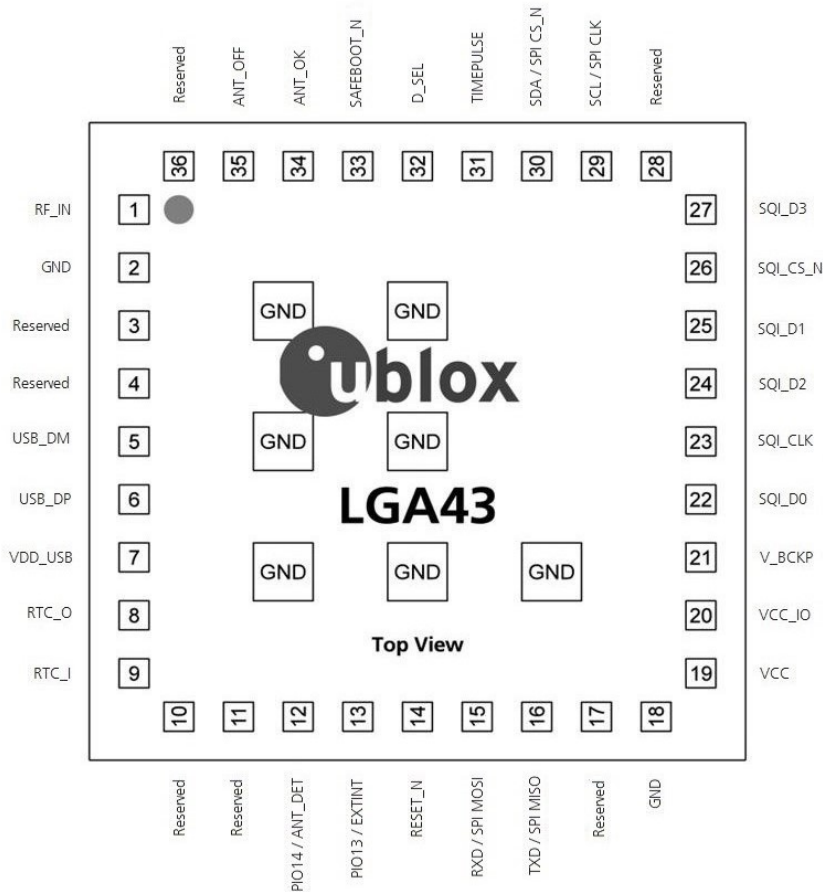

Figure 2: Pin assignment of EVA-M8M/Q

For multiple function PIOs, select the specific signal by sending the specific configuration message or by e-fusing.

Pin #	Name	I/O	Description	Remark
1	RF_IN	I	RF Input	Add external LNA and SAW if no active antenna used.
2	GND	I	Ground	
3	Reserved	I/O	Reserved	Do not connect. Must be left open!
4	Reserved	I/O	Reserved	Do not connect. Must be left open!
5	USB_DM	I/O	USB data	Leave open if not used.

Pin #	Name	I/O	Description	Remark
6	USB_DP	I/O	USB data	Leave open if not used.
7	VDD_USB	I	USB Interface power	Connect to GND if not used.
8	RTC_O	O	RTC Output	Leave open if no RTC Crystal attached.
9	RTC_I	I	RTC Input	Connect to GND if no RTC Crystal attached.
10	Reserved	I/O	Reserved	Do not connect. Must be left open!
11	Reserved	I/O	Reserved	Do not connect. Must be left open!
12	PIO14 / ANT_DET	I	Antenna detection	Leave open if not used.
13	PIO13 / EXTINT	I	External interrupt	Leave open if not used.
14	RESET_N	I	System reset	See section 1.19.
15	RXD / SPI MOSI	I	Serial interface	See section 1.17.6.
16	TXD / SPI MISO	O	Serial interface	See section 1.17.6.
17	Reserved	I/O	Reserved	Do not connect. Must be left open!
18	GND	I	Ground	
19	VCC	I	Main supply	
20	VCC_IO	I	I/O Supply	
21	V_BCKP	I	Backup supply	
22	SQI_D0	I/O	Data line 0 to external SQI flash memory or reserved configuration pin.	Leave open if not used.
23	SQI_CLK	I/O	Clock for external SQI flash memory or configuration pin.	Leave open if not used.
24	SQI_D2	I/O	Data line 2 to external SQI flash memory or reserved configuration pin.	Leave open if not used.
25	SQI_D1	I/O	Data line 1 to external SQI flash memory or reserved configuration pin.	Leave open if not used.
26	SQI_CS_N	I/O	Chip select for external SQI flash memory or configuration enable pin.	Leave open if not used.
27	SQI_D3	I/O	Data line 3 to external SQI flash memory or reserved configuration pin.	Leave open if not used.
28	Reserved	I/O	Reserved	Do not connect. Must be left open!
29	SCL / SPI CLK	I	Serial interface	See section 1.17.6.
30	SDA / SPI CS_N	I/O	Serial interface	See section 1.17.6.
31	TIMEPULSE	O	Time pulse output	Leave open if not used.
32	D_SEL	I	Interface selector	See section 1.17.6.
33	SAFEBOOT_N	I	Used for programming the SQI flash memory and testing purposes.	Leave open if not used.
34	ANT_OK	I	Antenna status	Leave open if not used.
35	ANT_OFF	O	Antenna control	Leave open if not used.
36	Reserved	I/O	Reserved	Do not connect. Must be left open!
37	GND	I	Ground	Inner ground pins
38	GND	I	Ground	Inner ground pins
39	GND	I	Ground	Inner ground pins
40	GND	I	Ground	Inner ground pins
41	GND	I	Ground	Inner ground pins
42	GND	I	Ground	Inner ground pins
43	GND	I	Ground	Inner ground pins

Table 7: EVA-M8M/Q pinout

2.2 Pin name changes

Selected pin names have been updated to agree with a common naming convention across u-blox modules. The pins have not changed their operation and are the same physical hardware but with updated names. The table below lists the pins that have changed name along with their old and new names.

No	Previous Name	New name
7	V_USB	VDD_USB
15	RX/MOSI	RXD/SPI MOSI
16	TX/MISO	TXD/SPI MISO
26	SQI_CS	SQI_CS_N
29	SCL/SCK	SCL/SPI CLK
30	SDA/CS_N	SDA/SPI CS_N

Table 8: Pin name changes

3 Electrical specification

The limiting values given are in accordance with the EOS System (IEC 134). Stress above one or more of the limiting values may cause permanent damage to the device. These are stress ratings only, and operation of the device at these or at any other conditions above those given in the Characteristics sections of the specification is not implied. Exposure to limiting values for extended periods may affect device reliability.

Where application information is given, it is advisory only and does not form part of the specification. For more information regarding power management, see the EVA-8M / EVA-M8 Hardware Integration Manual [1].

3.1 Absolute maximum rating

Parameter	Symbol	Module	Min	Max	Unit
Supply voltage	VCC	All	-0.5	3.6	V
Supply voltage I/O ring	VCC_IO	All	-0.5	3.6	V
Supply voltage USB	VDD_USB	All	-0.5	3.6	V
Supply voltage baseband backup core	V_BCKP	All	-0.5	3.6	V
Input voltage on RTC_I	V _{i RTC}	All	-0.5	1.6	V
Input voltage on Configurable Inputs, RESET_N	V _{i DIG}	All	-0.5	VCC_IO+0.5 3.6 if VCC_IO >= 3.1 V	V
RF Input power on RF_IN	Prfin	All		+15	dBm
Total power dissipation	Ptot	All		500	mW
Storage temperature	Ts	EVA-M8M	-40	+105	°C
		EVA-M8Q	-40	+85	°C

Table 9: Absolute maximum ratings

Stressing the device beyond the “Absolute Maximum Ratings” may cause permanent damage. These are stress ratings only. The product is not protected against overvoltage or reversed voltages. If necessary, voltage spikes exceeding the power supply voltage specification, given in table above, must be limited to values within the specified boundaries by using appropriate protection diodes.

3.2 Operating conditions

The test conditions specified in [Table 10](#) apply to all characteristics defined in this section.

Symbol	Parameter	Min	Typical	Max	Unit	Remarks
Tamb	Ambient temperature	-40	+25	+85	°C	
GND	Ground		0		V	
VCC	Core supply voltage		3.3		V	
V_BCKP	Backup battery supply voltage		3.3		V	
VCC_IO	Supply voltage I/O ring		3.3		V	
VDD_USB	Supply voltage USB		3.3		V	
NFtot	Receiver Chain Noise Figure		5.0		dB	

Table 10: Test conditions

All specifications are at an ambient temperature of +25 °C. Extreme operating temperatures can significantly impact specification values. Applications operating near the temperature limits should be tested to ensure the specification.

3.2.1 DC electrical characteristic

For Power Management Unit (PMU) block diagrams, see the EVA-8M / EVA-M8 Hardware Integration Manual [1].

Symbol	Parameter	Module	Min	Typical	Max	Unit
VCC_IO	Supply voltage for PIOs and input voltage for LDO_B and LDO_X	EVA-M8M	1.65	3.3	3.6	V
		EVA-M8Q	2.7	3.3	3.6	V
VDD_USB	Supply voltage USB	All	3.0	3.3	3.6	V
V_BCKP	Input voltage for LDO_B and LDO_X (backup mode)	All	1.4		3.6	V
VCC	Input voltage	EVA-M8M	1.65		3.6	V
		EVA-M8Q	2.7		3.6	V

Table 11: Power supply pins

Symbol	Parameter	Condition	Min	Typical	Max	Unit
Ileak	Leakage current input pins			< 1		nA
Vil	Low level input voltage		0		0.2*VCC_IO	V
Vih	High level input voltage		0.7*VCC_IO		VCC_IO+0.5	V
Vol	Low level output voltage for TXD/SPI MISO, RXD/SPI MOSI, SDA/SPI CS_N, SCL/SPI CLK, D_SEL, TIMEPULSE, PIO13/EXTINT, PIO14/ANT_DET, ANT_OK, ANT_OFF	I _{ol} = 4 mA			0.4	V
Voh	High level output voltage for TXD/SPI MISO, RXD/SPI MOSI, SDA/SPI CS_N, SCL/SPI CLK, D_SEL, TIMEPULSE, PIO13/EXTINT, PIO14/ANT_DET, ANT_OK, ANT_OFF	I _{oh} = 4 mA	VCC_IO-0.4			V
Rpu	Pull-up resistor for SDA/SPI CS_N, SCL/SPI CLK, TIMEPULSE, PIO13/EXTINT, PIO14/ANT_DET, RESET_N			11		kΩ
Rpu	Pull-up resistor for TXD/SPI MISO, RXD/SPI MOSI, D_SEL, ANT_OK, ANT_OFF			115		kΩ

Table 12: Digital IO pins

Symbol	Parameter	Condition	Min.	Typ.	Max.	Unit
Ileak	Leakage current input pins				1	μA
Vil	Low level input voltage	VDD_USB ≥ 3.0 V	0		0.8	V
Vih	High level input voltage	VDD_USB ≥ 3.0 V	2.0		VDD_USB	V
Vol	Low level output voltage	R _L = 1.425 kΩ to VDD_USB, VDD_USB ≥ 3.0 V, 27 Ω external series resistor			0.3	V
Voh	High level output voltage	R _L = 14.25 kΩ to GND, VDD_USB ≥ 3.0, 27 Ω external series resistor	2.8			V
Rpui	Pull-up resistor, Idle State		870	900	950	Ω
Rpuo	Pull-up resistor, Operational State		1400	1490	1600	Ω

Table 13: USB pins

3.2.2 Baseband parameters

Symbol	Parameter	Condition	Min.	Typ.	Max.	Unit
RTC_Fxtal	RTC crystal resonant frequency			32768		Hz
RTC_T_start	RTC startup time		0.2	0.35	0.9	sec
RTC_Amp	32768 Hz OSC oscillation amplitude		50		350	mVpp
RTC_ESR	32768 Hz Xtal equivalent series resistance				100	kΩ
RTC_CL	RTC integrated load capacitance	ESR = 80 kΩ	4	7	12	pF

Table 14: Baseband parameters

3.3 Indicative power requirements

Table 15 lists examples of the total system supply current for a possible application.

The values in Table 15 are provided for customer information only as an example of typical current requirements. The values are characterized on samples; actual power requirements can vary depending on FW version used, external circuitry, the number of SVs tracked, signal strength, type of start as well as time, duration and conditions of test.

Parameter	Symbol	Conditions	Module	Typ GPS & GLONASS	Typ GPS / QZSS / SBAS	Max	Units
Max. supply current ¹¹	Iccp		All			67	mA
Average supply current ¹²	Icc Acquisition ¹³	VCC_IO =	EVA-M8M	25	19		mA
		VCC = 3 V	EVA-M8Q	26	20		mA
	Icc Tracking (Continuous mode)	VCC_IO =	EVA-M8M	22	17		mA
		VCC = 3 V	EVA-M8Q	23	18		mA
Icc Tracking (Power Save mode / 1 Hz)	VCC_IO =	EVA-M8M	5.3	4.7		mA	
	VCC = 3 V	EVA-M8Q	6.2	5.7		mA	
Backup battery current ¹⁴	I_BCKP using the RTC crystal	HW Backup mode, VCC_IO =	All	15			μA
		VCC = 0 V					
	I_BCKP using the 26 MHz XTO in "single crystal" operation	HW Backup mode, VCC_IO =	EVA-M8M	100			μA
		VCC = 0 V	EVA-M8Q	N/A ¹⁵			
SW Backup current	I_SWBCKP using the RTC crystal	SW Backup mode, VCC_IO =	All	20			μA
		VCC = 3 V					
	I_SWBCKP using the 26 MHz XTO in "single crystal" operation	SW Backup mode, VCC_IO =	EVA-M8M	105			μA
		VCC = 3 V	EVA-M8Q	N/A ¹⁵			

Table 15: Currents to calculate the indicative power requirements

¹¹ Use this figure to dimension maximum current capability of power supply. Measurement of this parameter with 1 Hz bandwidth.

¹² Simulated constellation of 8 satellites is used. All signals are at -130 dBm. VCC= 3 V

¹³ Average current from start-up until the first fix.

¹⁴ Use this figure to determine required battery capacity.

¹⁵ Not applicable, feature not supported

For more information about power requirements, see the EVA-8M / EVA-M8 Hardware Integration Manual [1].

- All values in Table 15 are measured at +25 °C ambient temperature.
- For more information on how to noticeably reduce current consumption, see the Power Management Application Note [5].

3.4 SPI timing diagrams

In order to avoid incorrect operation of the SPI, the user needs to comply with certain timing conditions. The following signals need to be considered for timing constraints:

Symbol	Description
SPI CS_N (SS_N)	Slave select signal
SPI CLK (SCK)	Slave clock signal

Table 16: Symbol description

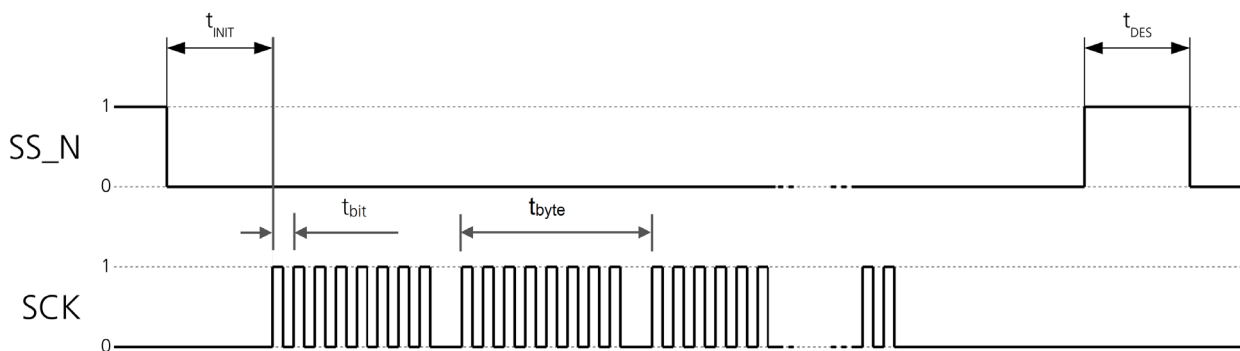

Figure 3: SPI timing diagram

3.4.1 Timing recommendations

The SPI timing recommendations are given below.

Parameter	Description	Recommendation
t_{INIT}	Initialization Time	10 μ s
t_{DES}	Deselect Time	1 ms.
t_{bit}	Minimum bit time	180 ns (5.5 MHz max bit frequency)
t_{byte}	Minimum byte period	8 μ s (125 kHz max byte frequency)

Table 17: SPI timing recommendations

- The values in the above table result from the requirement of an error-free transmission. By allowing just a few errors and disabling the glitch filter, the bit rate can be increased considerably.

3.5 DCC timing diagrams

The DDC interface is I²C Fast Mode compliant. For timing parameters consult the I²C standard.

- The maximum bit rate is 400 kbit/s. The interface stretches the clock when slowed down when serving interrupts, so real bit rates may be slightly lower.

4 Mechanical specification

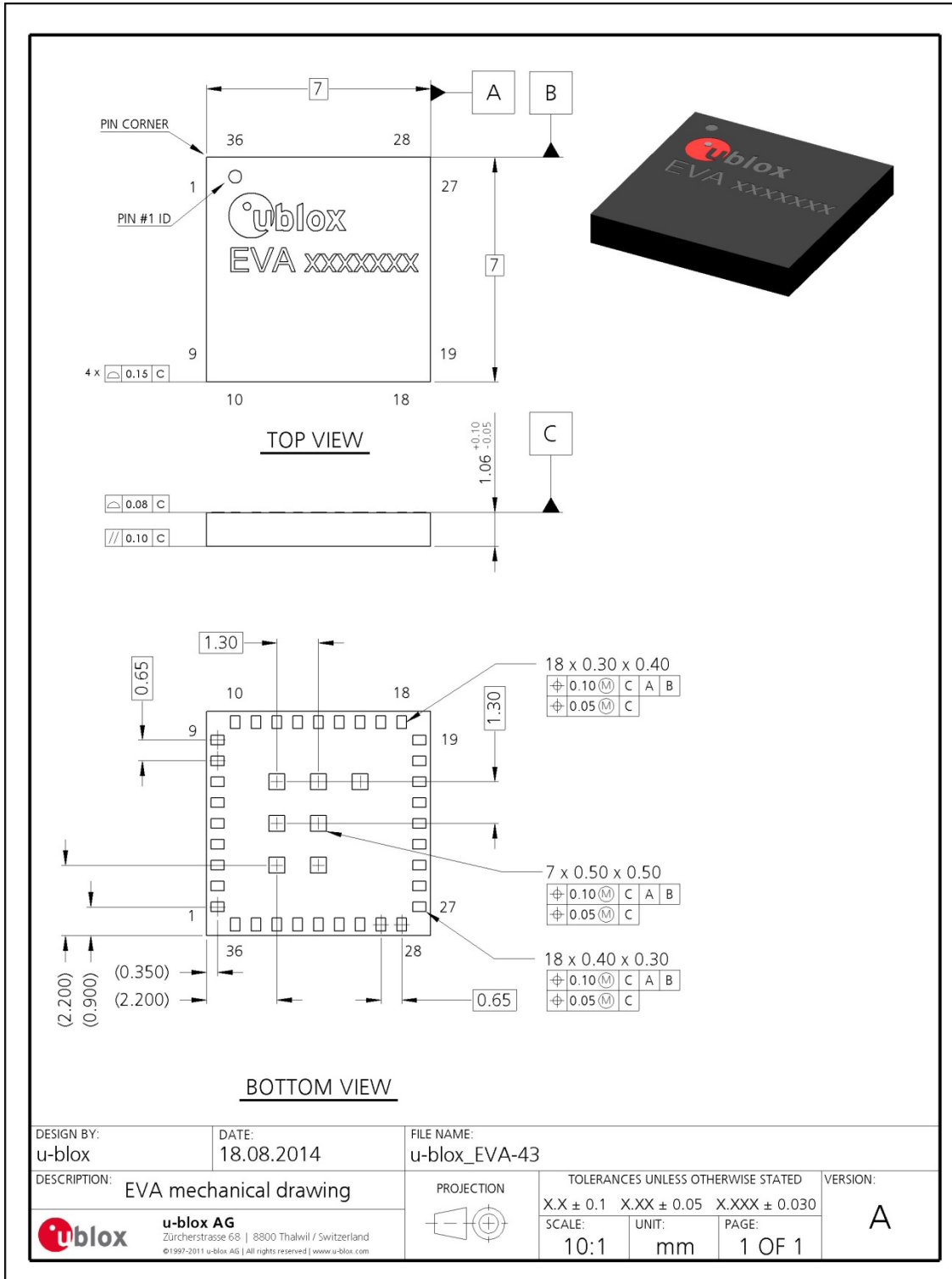

Figure 4: Mechanical drawing for EVA-M8M/Q (LGA43)

5 Reliability tests and approvals

5.1 Reliability tests

Qualification requirements according JEDEC standards JESD47 "Stress-Test-Driven Qualification of Integrated Circuits".

5.2 Approvals



The EVA-M8M and EVA-M8Q modules comply with the Directives 2011/65/EU and 2015/863/EU of the European Parliament and the Council on the Restriction of Use of certain Hazardous Substances (RoHS).

6 Product handling

6.1 Packaging

EVA-M8M/Q GNSS series modules are delivered as hermetically sealed, reeled tapes in order to enable efficient production, production lot set-up and tear-down. For more information about packaging, see the u-blox Package Information Guide [3].

6.1.1 Reels

EVA-M8M/Q GNSS series modules are deliverable in quantities of 500 pieces on a reel. The EVA-M8M/Q modules are shipped on Reel Type D, as described in the u-blox Package Information Guide [3].

6.1.2 Tapes

Figure 5 shows the feed direction and the orientation of the EVA-M8M/Q positioning modules on the tape. The positioning modules are placed such that the pin 1 is at the upper right for the LGA43. The dimensions of the tapes are specified in Figure 6.

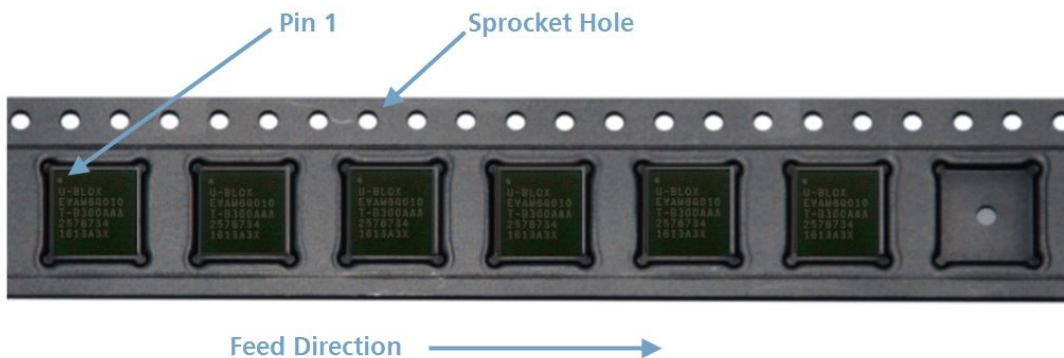
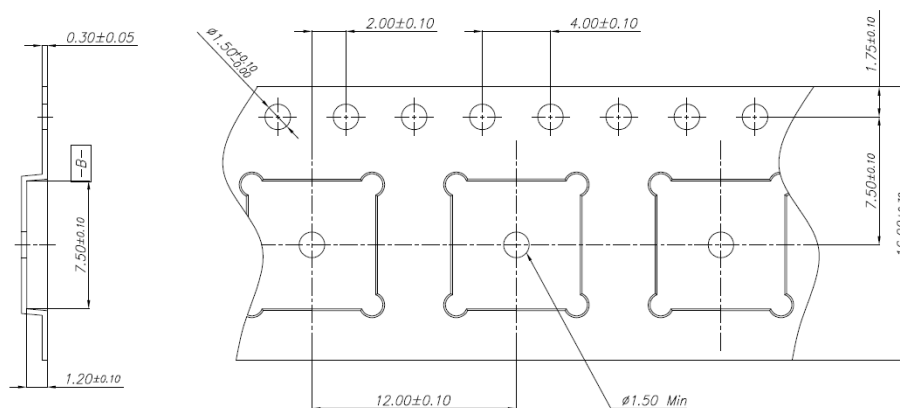

Figure 5: Orientation of EVA-M8M/Q modules on the tape



NOTES:

1. 10 sprocket hole pitch cumulative tolerance ± 0.2
2. Camber not to exceed 1mm in 100mm
3. Material: Clear Polystyrene
4. A_0 and B_0 measured on a plane 0.3mm above the bottom of the pocket
5. K_0 measured from a plane on the inside bottom of the pocket to the top surface of the carrier.
6. Pocket position relative to sprocket hole measured as true position of pocket, not pocket hole.
7. Pocket center and pocket hole center must be same position.

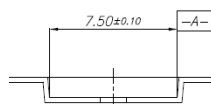

Figure 6: EVA-M8M/Q tape dimensions

6.2 Shipment, storage and handling

For important information regarding shipment, storage and handling see the u-blox Package Information Guide [3]. The absolute maximum rating of the storage temperature specified in section 3.1 apply to the storage of the module both before and after soldering. Required storage conditions for modules in reeled tapes and for naked modules before soldering are described in the u-blox Package Information Guide [3].

6.3 Moisture Sensitivity Levels

The Moisture Sensitivity Level (MSL) relates to the packaging and handling precautions required. EVA-M8M and EVA-M8Q¹⁶ modules are rated at MSL level 3.

For MSL standard see IPC/JEDEC J-STD-020, which can be downloaded from www.jedec.org.

For more information regarding MSL, see the u-blox Package Information Guide [3].

6.4 Reflow soldering

Reflow profiles are to be selected according u-blox recommendations (see the EVA-8M / EVA-M8 Hardware Integration Manual [1]).

6.5 ESD handling precautions

EVA-M8M/Q modules contain highly sensitive electronic circuitry and are Electrostatic Sensitive Devices (ESD). Observe precautions for handling! Failure to observe these precautions can result in severe damage to the GNSS receiver!

GNSS receivers are Electrostatic Sensitive Devices (ESD) and require special precautions when handling. Particular care must be exercised when handling patch antennas, due to the risk of electrostatic charges. In addition to standard ESD safety practices, the following measures should be taken into account whenever handling the receiver:

- Unless there is a galvanic coupling between the local GND (i.e. the work table) and the PCB GND, the first point of contact when handling the PCB must always be between the local GND and PCB GND.
- Before mounting an antenna patch, connect ground of the device
- When handling the RF pin, do not come into contact with any charged capacitors and be careful when contacting materials that can develop charges (e.g. patch antenna ~10pF, coax cable ~50-80 pF/m, soldering iron, ...)
- To prevent electrostatic discharge through the RF input, do not touch any exposed antenna area. If there is any risk that such exposed antenna area is touched in non ESD protected work area, implement proper ESD protection measures in the design.
- When soldering RF connectors and patch antennas to the receiver's RF pin, make sure to use an ESD safe soldering iron (tip).



¹⁶ only two reflow soldering processes are done in the MSL qualification due to internal component limitation.

7 Default messages

Interface	Settings
UART Output	9600 Baud, 8 bits, no parity bit, 1 stop bit Configured to transmit both NMEA and UBX protocols, but only the following NMEA (no UBX) messages have been activated at start-up: GGA, GLL, GSA, GSV, RMC, VTG, TXT
USB Output	Configured to transmit both NMEA and UBX protocols, but only the following NMEA (no UBX) messages have been activated at start-up: GGA, GLL, GSA, GSV, RMC, VTG, TXT USB Power Mode: Bus Powered
UART Input	9600 Baud, 8 bits, no parity bit, 1 stop bit, Autobauding disabled Automatically accepts following protocols without need of explicit configuration: UBX, NMEA, RTCM The GNSS receiver supports interleaved UBX and NMEA messages.
USB Input	Automatically accepts following protocols without need of explicit configuration: UBX, NMEA, RTCM The GNSS receiver supports interleaved UBX and NMEA messages. USB Power Mode: Bus Powered
DDC	Fully compatible with the I ² C industry standard, available for communication with an external host CPU or u-blox cellular modules, operated in slave mode only. Default messages activated. NMEA and UBX are enabled as input messages, only NMEA as output messages. Maximum bit rate 400 kb/s.
SPI	Allow communication to a host CPU, operated in slave mode only. Default messages activated. SPI is not available in the default configuration
TIMEPULSE (1 Hz Nav)	1 pulse per second, synchronized at rising edge, pulse length 100 ms

Table 18: Default messages

 Refer to the u-blox 8 / u-blox M8 Receiver Description Including Protocol Specification [\[2\]](#) for information about other settings.

8 Labeling and ordering information

8.1 Product labeling

The labeling of u-blox EVA form factor GNSS modules includes important product information. The location of the EVA-M8M/Q product type number is shown in [Figure 7](#).

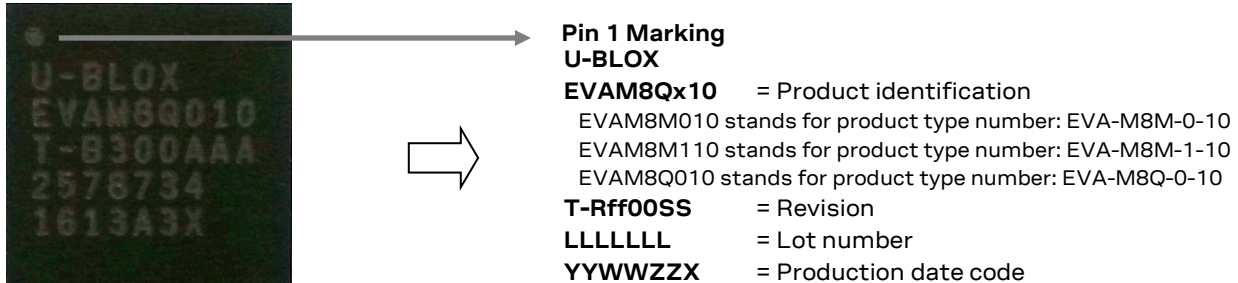

Figure 7: Description of EVA-M8Q product label

8.2 Explanation of product codes

Three different product code formats are used. The **Product Name** is used in documentation such as this data sheet and identifies all u-blox M8 products, independent of packaging and quality grade. The **Ordering Code** includes packaging and quality, while the **Type Number** includes the hardware and firmware versions. [Table 19](#) below details these three different formats:

Format	Structure
Product Name	PPP-TGV-N
Ordering Code	PPP-TGV-N
Type Number	PPP-TGV-N-XX

Table 19: Product code formats

The parts of the product code are explained in [Table 20](#).

Code	Meaning	Example
PPP	Product Family	EVA
TG	Technology & Generation	M8 = u-blox M8
V	Variant	Function set (A-Z)
N	Option/ Quality Grade	Describes standardized functional element or quality grade 0 = Default variant, A = Automotive
XX	Product Detail	Describes product details or options such as hardware and software revision, cable length, etc.

Table 20: Part identification code

8.3 Ordering codes

Ordering No.	Product
EVA-M8M-0	u-blox M8 GNSS LGA Module, crystal, ROM, green, 7.0x7.0 mm, 500 pieces/reel (Default: GPS + GLONASS)
EVA-M8M-1	u-blox M8 GNSS LGA Module, crystal, ROM, green, 7.0x7.0 mm, 500 pieces /reel (Default: GPS + BeiDou)
EVA-M8Q-0	u-blox M8 GNSS LGA Module, TCXO, ROM, green, 7.0x7.0 mm, 500 pieces /reel (Default: GPS + GLONASS)

Table 21: Product ordering codes for professional grade positioning modules

Product changes affecting form, fit or function are documented by u-blox. For a list of Product Change Notifications (PCNs), see our website.

Appendix

A Glossary

Abbreviation	Definition
AEC	Automotive Electronics Council
BBR	Battery Backed RAM
DDC	Display Data Channel
EGNOS	European Geostationary Navigation Overlay Service
GAGAN	GPS Aided GEO Augmented Navigation
GNSS	Global Navigation Satellite System
GLONASS	GLObal Navigation Satellite System (Russian)
GND	Ground
GPS	Global Positioning System
IMES	Indoor MESSaging System
LCS	LoCation Services (protocol)
LGA	Land Grid Array
LNA	Low Noise Amplifier
MSAS	MTSAT Satellite Augmentation System
MSL	Moisture Sensitivity Level
NMEA	National Marine Electronics Association
PCB	Printed Circuit Board
PCN	Product Change Notification
QZSS	Quasi-Zenith Satellite System
RLM	Return Link Message
RRLP	Radio Resource LCS Protocol
RTC	Real Time Clock
RTCM	Radio Technical Commission for Maritime Services
SAW	Surface Acoustic Wave
SBAS	Satellite-Based Augmentation System
SCL	Serial Clock
SUPL	Secure User Plane Location
TCXO	Temperature-Compensated Crystal Oscillator
TTF	Time-To-First-Fix
UART	Universal Asynchronous Receiver/Transmitter
WAAS	Wide Area Augmentation System

Table 22: Explanation of the abbreviations and terms used

Related documents

- [1] EVA-8M / EVA-M8 Hardware Integration Manual, Doc. No. UBX-16010593
- [2] u-blox 8 / u-blox M8 Receiver Description Including Protocol Specification (Public version), Doc. No. UBX-13003221
- [3] u-blox Package Information Guide, Doc. No. UBX-14001652
- [4] RTCM 10402.3 Recommended Standards for Differential GNSS, Ver. 2.3, RTCM AUG. 20, 2001
- [5] Power Management Application Note, Doc. No. UBX-13005162
- [6] Radio Resource LCS Protocol (RRLP), (3GPP TS 44.031 version 11.0.0 Release 11)

 For regular updates to u-blox documentation and to receive product change notifications, register on our homepage (www.u-blox.com).

Revision history

Revision	Date	Name	Comments
R01	15-Jun-2016	njaf	Objective Specification
R02	15-Aug-2016	julu	Advance Information, added EVA-M8Q related footnote in section 6.2 (MSL).
R03	20-Jan-2017	jesk	Early Production Information, updated supply voltage range for EVA-M8Q in section 1.2 and Table 11, updated section 1.5 with QZSS clarification and Galileo Initial Services, corrected reference to RRLP specification in section 1.8, added section 6.2 (storage temperature statement) and section 6.5 (soldering instruction).
R04	12-Jun-2018	jesk,mbab	Updated supply voltage range for EVA-M8Q in section 1.2 and in Table 11 (EVA-M8Q supports only the 2.7 V to 3.6 V voltage range). Updated AssistNow Autonomous compatibility in section 1.6.3. Reformat
R05	10-May-2019	jesk	Production Information document status. Updated Absolute maximum rating in section 3.1 and RoHS directives in section 5.2.

Contact

For complete contact information, visit us at www.u-blox.com.

u-blox Offices

North, Central and South America

u-blox America, Inc.

Phone: +1 703 483 3180
E-mail: info_us@u-blox.com

Regional Office West Coast:

Phone: +1 408 573 3640
E-mail: info_us@u-blox.com

Technical Support:

Phone: +1 703 483 3185
E-mail: support@u-blox.com

Headquarters

Europe, Middle East, Africa

u-blox AG

Phone: +41 44 722 74 44
E-mail: info@u-blox.com
Support: support@u-blox.com

Asia, Australia, Pacific

u-blox Singapore Pte. Ltd.

Phone: +65 6734 3811
E-mail: info_ap@u-blox.com
Support: support_ap@u-blox.com

Regional Office Australia:

Phone: +61 2 8448 2016
E-mail: info_anz@u-blox.com
Support: support_ap@u-blox.com

Regional Office China (Beijing):

Phone: +86 10 68 133 545
E-mail: info_cn@u-blox.com
Support: support_cn@u-blox.com

Regional Office China (Chongqing):

Phone: +86 23 6815 1588
E-mail: info_cn@u-blox.com
Support: support_cn@u-blox.com

Regional Office China (Shanghai):

Phone: +86 21 6090 4832
E-mail: info_cn@u-blox.com
Support: support_cn@u-blox.com

Regional Office China (Shenzhen):

Phone: +86 755 8627 1083
E-mail: info_cn@u-blox.com
Support: support_cn@u-blox.com

Regional Office India:

Phone: +91 80 405 092 00
E-mail: info_in@u-blox.com
Support: support_in@u-blox.com

Regional Office Japan (Osaka):

Phone: +81 6 6941 3660
E-mail: info_jp@u-blox.com
Support: support_jp@u-blox.com

Regional Office Japan (Tokyo):

Phone: +81 3 5775 3850
E-mail: info_jp@u-blox.com
Support: support_jp@u-blox.com

Regional Office Korea:

Phone: +82 2 542 0861
E-mail: info_kr@u-blox.com
Support: support_kr@u-blox.com

Regional Office Taiwan:

Phone: +886 2 2657 1090
E-mail: info_tw@u-blox.com
Support: support_tw@u-blox.com

X-ON Electronics

Largest Supplier of Electrical and Electronic Components

Click to view similar products for [GPS Modules](#) category:

Click to view products by [U-Blox](#) manufacturer:

Other Similar products are found below :

[EWM-G109H01E](#) [ISM3333-C6.1](#) [GPS-11858](#) [SL871GPS232R001](#) [DD-14239](#) [GPS-10922](#) [M20050-1](#) [M20048-1](#) [S2-105Y0-Z1E0G](#)
[SIM28ML](#) [EWM-G110H01E](#) [WISE-4610P-NA](#) [M10578-A3](#) [M10578-A3-U2](#) [GPS-13740](#) [A2200-A](#) [MIKROE-4150](#) [28504](#) [L26ADR-S89](#)
[L26-M33](#) [L26T-S89](#) [L70B-M39](#) [L76L-M33](#) [L89-S90](#) [L96-M33](#) [S2-10640-Z1G0D](#) [EL.1A](#) [4037735105317](#) [4037735105331](#) [W2SG0084i-B-](#)
[T](#) [EWM-G108H01E](#) [TEL0132](#) [PKG300060P](#) [PKG300071](#) [PKG900000000271T](#) [RXM-GPS-F4-T](#) [RXM-GPS-FM-B](#) [A1084-A](#) [A2100-A](#)
[GPS-13670](#) [GYSFFMAXC](#)