

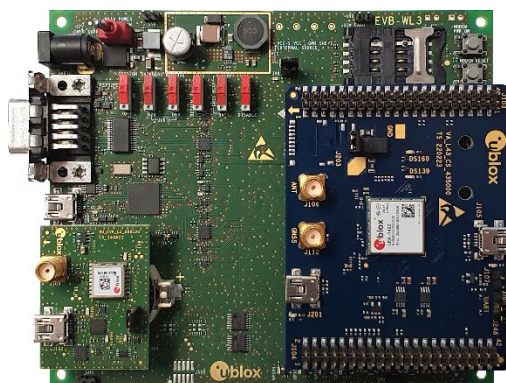

EVK-LEXI-R422

LEXI-R422 cellular evaluation kit

User guide



Abstract

This guide explains how to set up the EVK-LEXI-R422 evaluation kit to begin evaluating the u-blox ultra-small LEXI-R422 modules supporting multi-band LTE-M / NB-IoT / EGPRS cellular radio access technology for low power wide area solutions.

Document information

Title	EVK-LEXI-R422	
Subtitle	LEXI-R422 cellular evaluation kit	
Document type	User guide	
Document number	UBXDOC-686885345-1758	
Revision and date	R02	06-Oct-2023
Disclosure restriction	C1-Public	

This document applies to the following products:

Product name	Type number
EVK-LEXI-R422	EVK-LEXI-R422-01-00

u-blox or third parties may hold intellectual property rights in the products, names, logos and designs included in this document. Copying, reproduction, modification or disclosure to third parties of this document or any part thereof is only permitted with the express written permission of u-blox.

The information contained herein is provided "as is" and u-blox assumes no liability for its use. No warranty, either express or implied, is given, including but not limited to, with respect to the accuracy, correctness, reliability and fitness for a particular purpose of the information. This document may be revised by u-blox at any time without notice. For the most recent documents, visit www.u-blox.com.

Copyright © u-blox AG.

Contents

Document information	2
Contents	3
1 Introduction	4
2 Board quick start	5
2.1 Board setup	5
2.1.1 SIM and antenna	5
2.1.2 Power supply	6
2.1.3 Local connectivity	7
2.2 Switch on the cellular system.....	8
2.3 Switch off the cellular system.....	9
3 Register to network	10
3.1 Enabling error result codes	10
3.2 PIN code insertion (when required).....	10
3.3 Registration on a cellular network.....	10
4 Setting up cellular packet data connection on Windows	11
4.1 Install a new modem from the control panel	11
4.2 Configuring a new connection	13
5 EVK-LEXI-R422 hardware	14
5.1 EVK-LEXI-R422 block diagram and basic description	14
5.2 Switches, jumpers and buttons	16
5.3 LEDs.....	17
5.4 Connectors	18
5.5 EVK-LEXI-R422 pin out.....	19
5.6 Current consumption measurement	21
Appendix	22
A Setting up AT terminal communication	22
B Glossary	24
C Declaration of conformities	25
Related documentation	25
Revision history	25
Contact	25

1 Introduction

The EVK-LEXI-R422 kit is a powerful and easy-to-use tool that simplifies the evaluation of the u-blox LEXI-R422 multi-band LTE-M / NB-IoT / EGPRS cellular modules.

See the LEXI-R422 data sheet [2] and the LEXI-R422 system integration manual [3] for features supported by LEXI-R422 modules.

As shown in Figure 1, the EVK-LEXI-R422 evaluation kit is formed by three boards:

- The EVB-WL3 contains the power supply and other peripherals for the cellular module
- The cellular adapter board, ADP-LEXI-R422, contains the LEXI-R422 cellular module and other connectors
- The GNSS adapter board, ADP-GNSS, contains the u-blox MAX-M10S GNSS module, the GNSS antenna connector and the USB connector for the GNSS module

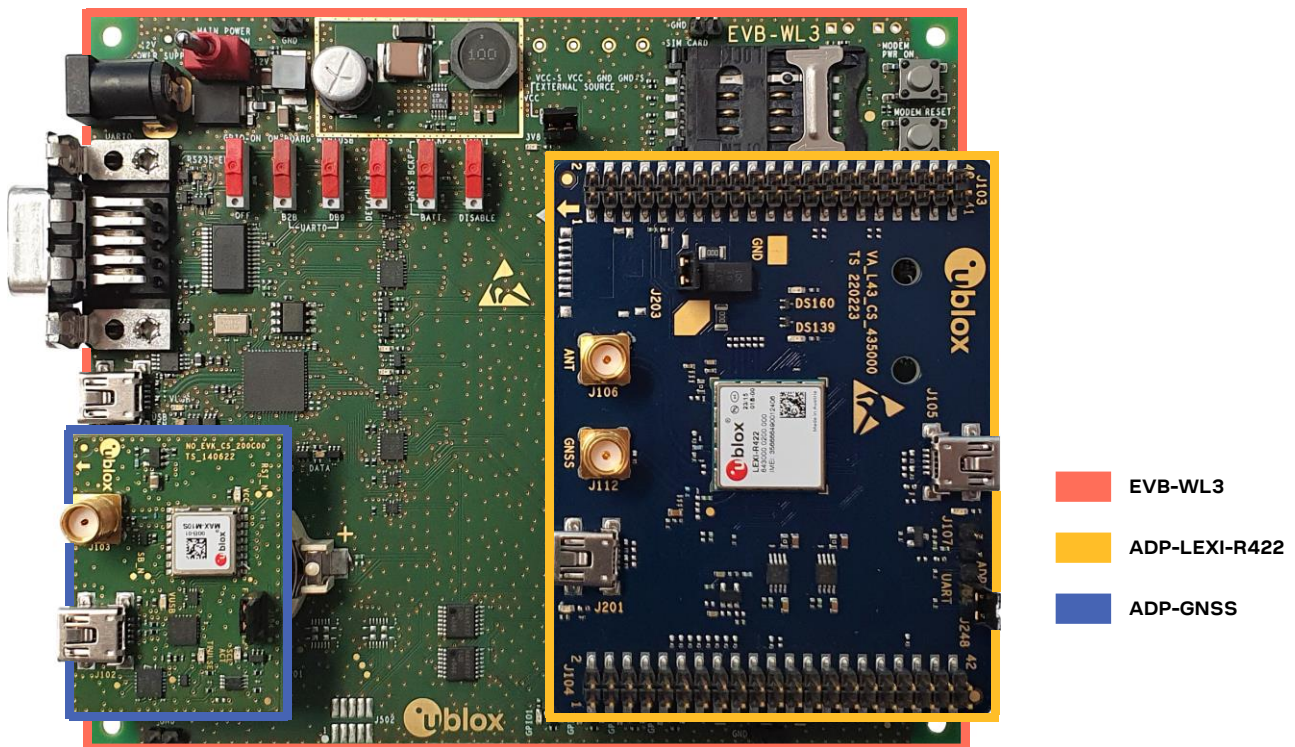

Figure 1: EVK-LEXI-R422 evaluation kit formed by three boards

For more hardware details about the EVK-LEXI-R422 evaluation kit, see section 5.

2 Board quick start

2.1 Board setup

2.1.1 SIM and antenna

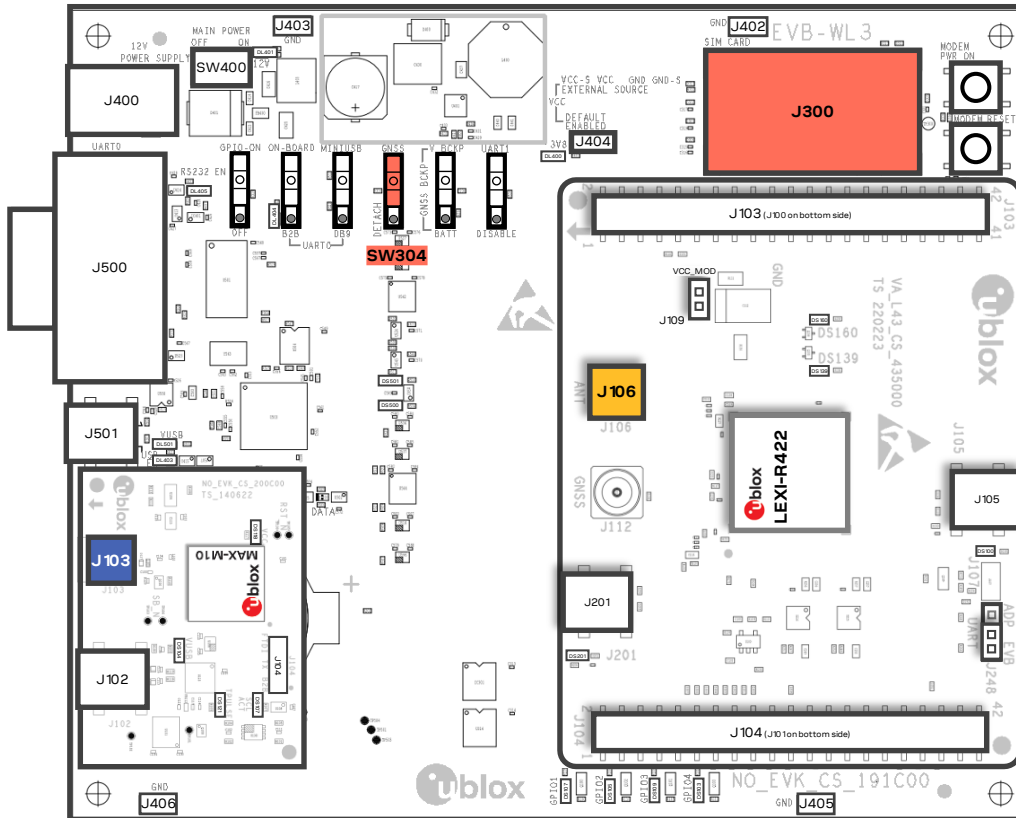

Figure 2: SIM and antenna set up

1. Insert a SIM card into **J300**, the SIM card holder;
2. Connect the cellular antenna provided with the EVK-LEXI-R422 evaluation kit box to **J106**, the cellular antenna SMA connector;
3. If GNSS functionality is required, connect the GNSS antenna provided with the EVK-LEXI-R422 evaluation kit box to **J103**, the GNSS antenna SMA connector on ADP-GNSS, and keep the cellular GNSS detach switch **SW304** in “GNSS” position;

Place the GNSS antenna in a location with a good view of the sky.

2.1.2 Power supply

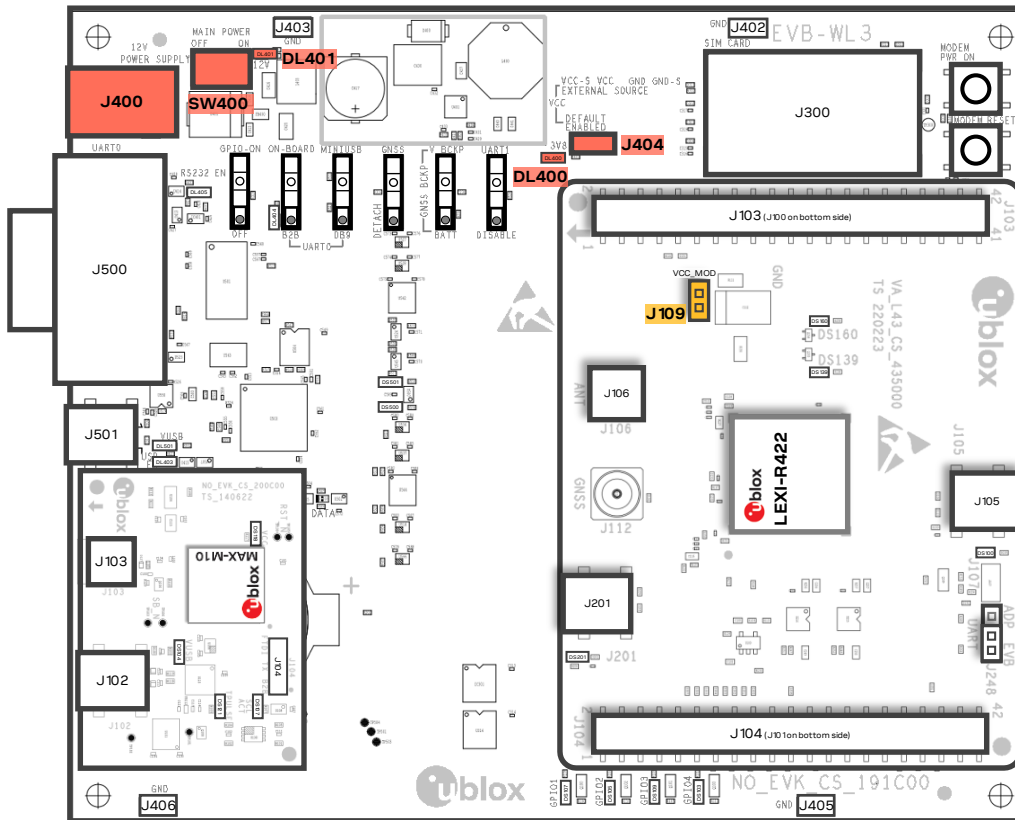

Figure 3: Power supply set up

1. Connect the AC/DC +12 V power supply adapter to **J400**, the 9 – 18 V power input connector; LED **DL401** light turns blue;
2. Provide a jumper socket on both **J404** and **J109**, the cellular VCC supply jumpers;
3. Turn **SW400**, the main power switch, to the “ON” position; LED **DL400** light turns green.

2.1.3 Local connectivity

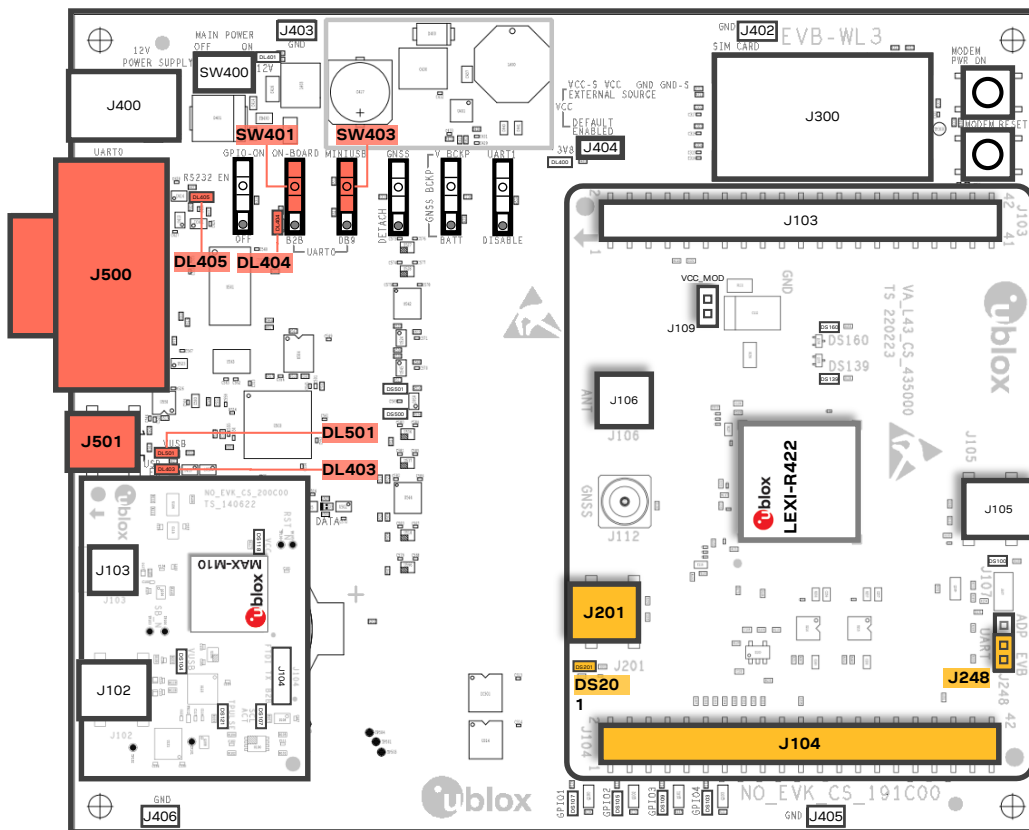

Figure 4: Local connectivity set up

For communication via the UART interfaces of the cellular module, the following connections are allowed and can be alternatively enabled in a mutually exclusive way (see [Table 1](#) for switches and jumper position and LED status):

- Connect a USB cable to **J501** (mini-USB), the cellular USB main UART; the LED **DL501** light turns blue. When a USB cable is connected to this mini-USB connector, two COM ports are enabled in Windows: the main 8-wire UART interface of the cellular system is available over the first COM port opened by the driver, after the end of the cellular system boot once the cellular system is switched on.
- Connect an RS232 cable to **J500**, the cellular RS232 main UART, a DB9 connector: the main 8-wire UART interface of the cellular system is available over RS232, after the cellular system boot once the cellular system is switched on.
- Connect a USB cable to **J201** (mini-USB), the cellular USB two UARTs; the LED **DS201** light turns blue. When a USB cable is connected to this mini-USB connector, two COM ports are enabled in Windows: the two 4-wire UART interfaces of the cellular system are respectively available over the two numbered COM ports opened by the driver, after the end of the cellular system boot once the cellular system is switched on (to enable two UART interfaces, see the AT commands manual [\[1\]](#), +USIO AT command).

Type of connections	SW401	SW403	J248	LED
Access to the main UART interface over J501 (EVB-WL3)	ON BOARD	MINIUSB	Jumper socket on pins 1-2	DL403 DL501
Access to the main UART interface over J500 (EVB-WL3)	ON BOARD	DB9	Jumper socket on pins 1-2	DL405
Access to the two UART interfaces over J201 (ADP-LEXI-R422)	B2B	Do not care	Jumper socket on pins 2-3	DL404 DS201
Access to UART interface(s) over J104 (ADP-LEXI-R422)	B2B	Do not care	No jumper socket	DL404

Table 1: Serial interface configuration

See the LEXI-R422 data sheet [2] and the +USIO AT command description in the AT commands manual [1] for the description and configuration of the USIO variants.

Run an AT terminal application (such as the u-blox m-center tool) selecting the AT port, with these settings:

Data rate	Data bits	Parity	Stop bits	Flow control
115200 bit/s	8	N	1	HW

See appendix A for how to configure the u-blox m-center AT terminal for Windows.

2.2 Switch on the cellular system

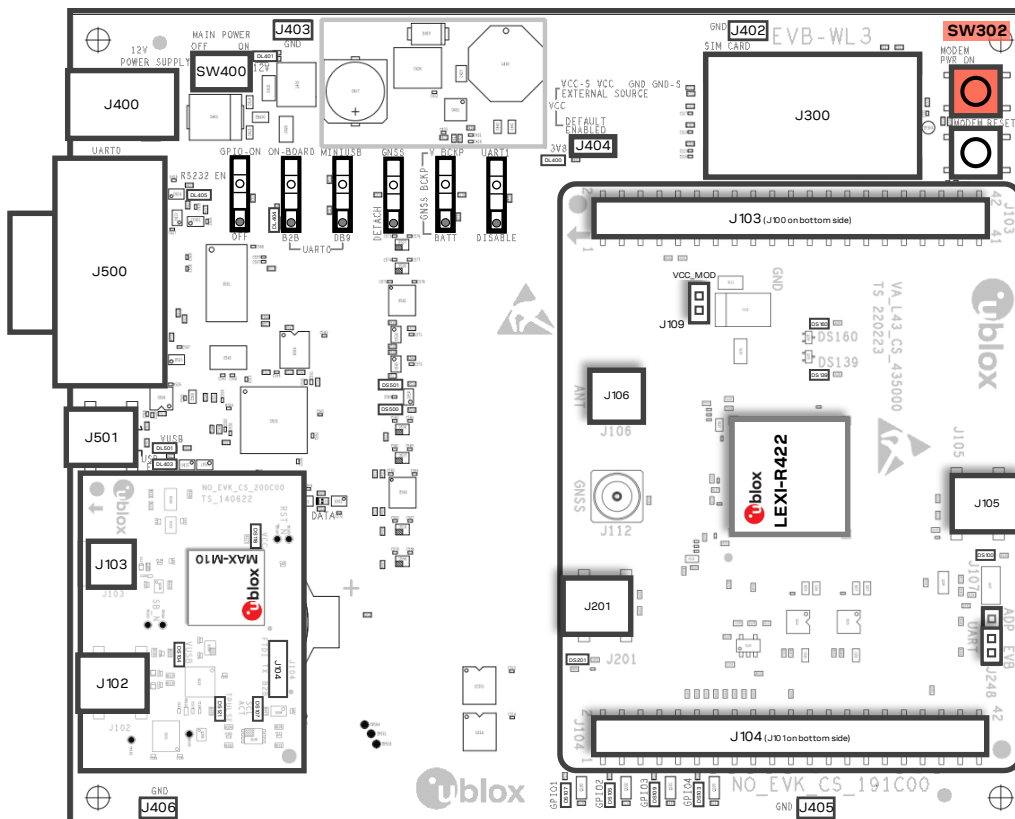
Figure 5: Cellular power-ctrl push button

To switch on the cellular system in the EVK-LEXI-R422, press **SW302**, the cellular power-ctrl button.

2.3 Switch off the cellular system

To switch off the cellular system in the EVK-LEXI-R422, send the +CPWROFF AT command.

-  Issue AT+CPWROFF command before switching off the main power supply, otherwise settings and configuration parameters may not be saved in the non-volatile memory of the cellular module.

3 Register to network

3.1 Enabling error result codes

Command sent by DTE (user)	DCE response (module)	Description
AT+CMEE=2	OK	Enable the cellular module to report verbose error result codes.

3.2 PIN code insertion (when required)

Command sent by DTE (user)	DCE response (module)	Description
AT+CPIN="8180"	OK	Enter the PIN code, if needed (enter the PIN of the SIM card – 8180 is an example).
AT+CLCK="SC",0,"8180"	OK	Unlock the PIN at power-on (the last parameter is the PIN of the SIM card – 8180 is an example).
AT+CLCK="SC",1,"8180"	OK	Lock the PIN at power-on (the last parameter is the PIN of the SIM card – 8180 is an example).

3.3 Registration on a cellular network

Command sent by DTE (user)	DCE response (module)	Description
AT+CREG?	+CREG: 0,1 OK	Verify the CS network registration.
AT+CEREG?	+CEREG: 0,1,"5684","03761b14",7 OK	Verify the EPS network registration.
AT+COPS=0	OK	Register the module on the network. The cellular module automatically registers itself on the cellular network. This command is necessary only if the auto-registration failed (AT+CREG? returns 0,0).
AT+COPS?	+COPS: 0,0,"I TIM",7 OK	Read the operator name and radio access technology (RAT).

For the complete description and syntax of the AT commands supported by LEXI-R422 modules, see the AT commands manual [\[1\]](#).

4 Setting up data connection on Windows

This section describes how to set up a cellular packet data connection on Windows 10 using the operating system's TCP/IP stack and EVK-LEXI-R422. This is also referred to as a dial-up connection.

4.1 Install a new modem from the control panel

1. From **Control Panel**, select **Phone and Modem > Modems > Add**.

This opens the Add Hardware Wizard.

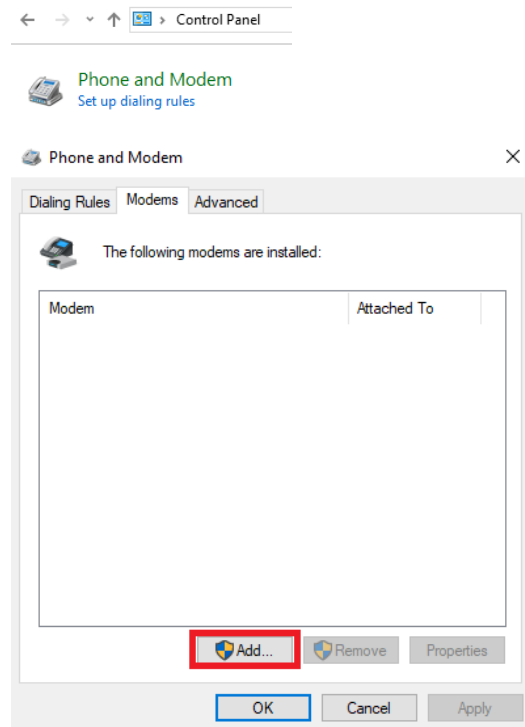

2. Tick "Don't detect my modem" checkbox. Click **Next**.

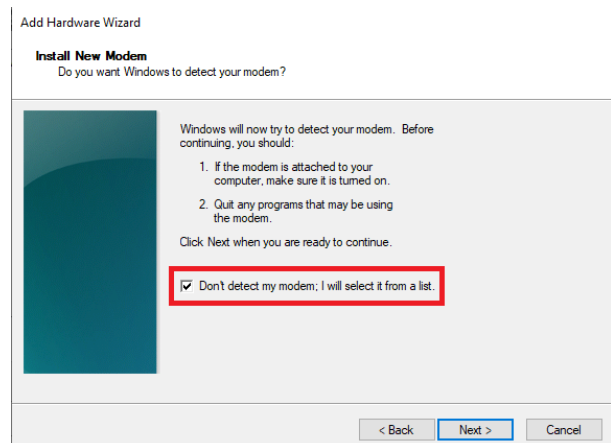

3. Select **Standard 33600 bps Modem**.
Click **Next**.

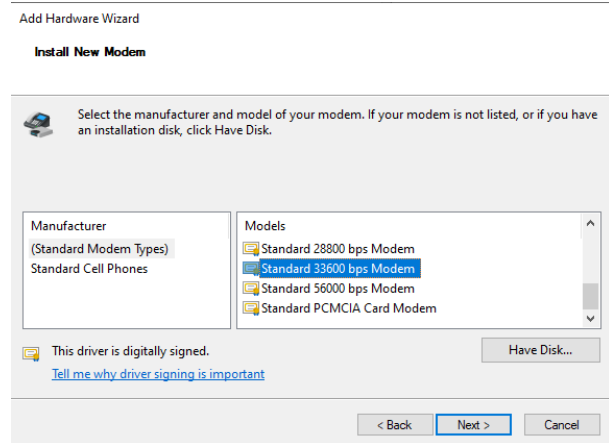

4. Select **COM** port for data communication and click **Next**. The modem will be installed on this COM port.

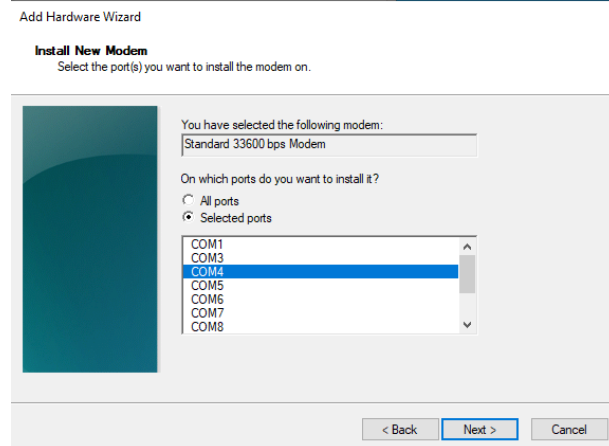

6. Now the new modem is visible in **Control Panel**, under **Phone and Modem > Modems**.
Any extra initialization AT command (e.g., to set a specific APN name) can be entered by selecting **Properties** and filling in **Advanced > Extra initialization commands** text box.

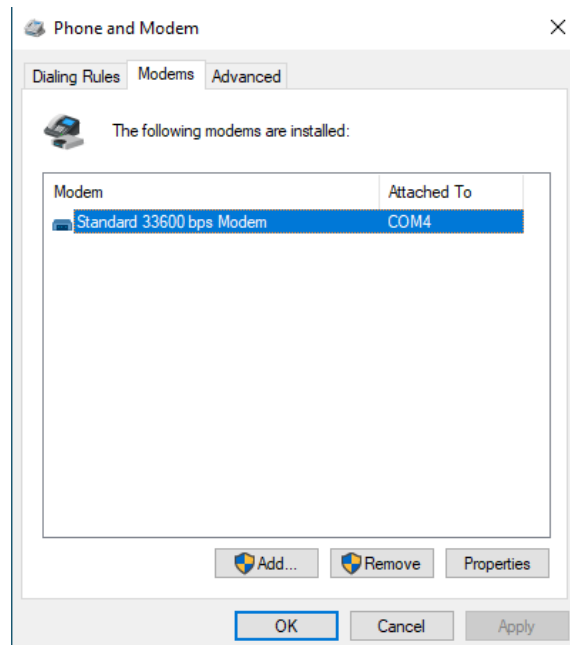

Now the module is ready and the connection can be configured.

The modem configuration can also be edited in **Device Manager**, by clicking on the modem name.

4.2 Configuring a new connection

1. From **Control Panel**, select **Network and Sharing Center** > **Set up a new connection or network**.

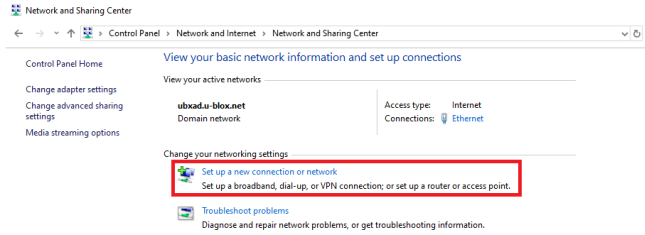

2. Click **Connect to the Internet** and then **Next**.

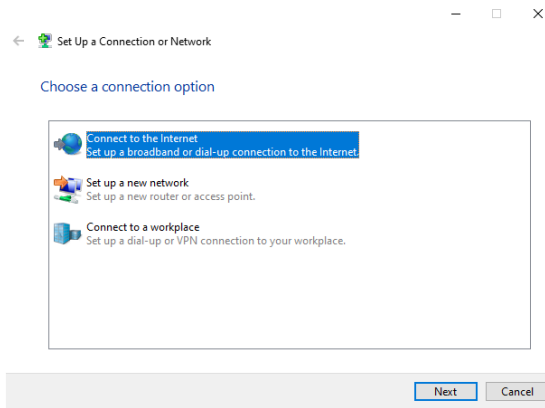

3. Select **Dial-up** and, if requested, the modem previously installed.

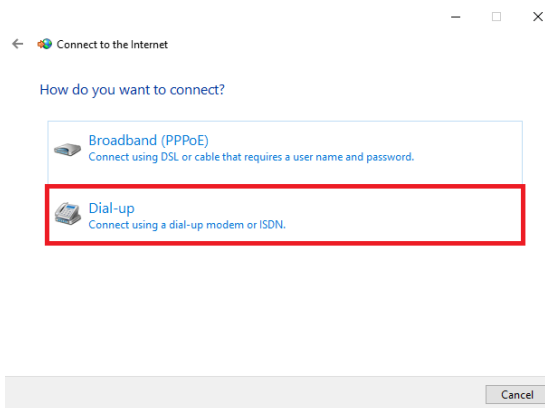

4. Enter the parameters for the dial-up connection:

- The module telephone number:
*99***1#
(change, if using a PDP context different from 1)
- The specific account information for the network operator
- A name for the connection, e.g.,
“EVK-LEXI-R422 dial-up”

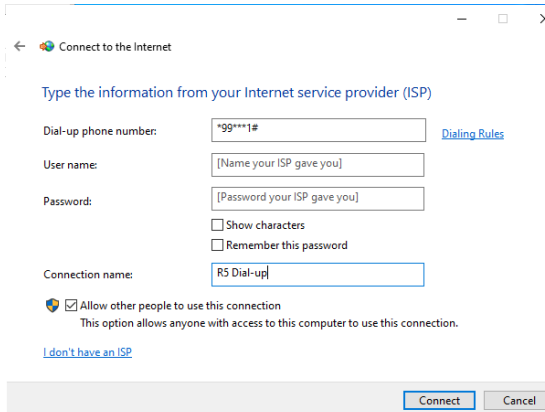

The packet data connection is now ready to be used with EVK-LEXI-R422. Click **Connect** to start the connection, then start a browser to check internet connectivity.

Consult the cellular network operator for username and password. In most cases, they can be left empty.

5 EVK-LEXI-R422 hardware

5.1 EVK-LEXI-R422 block diagram and basic description

Figure 6 shows the main interfaces and internal connections of the EVK-LEXI-R422 evaluation kit:

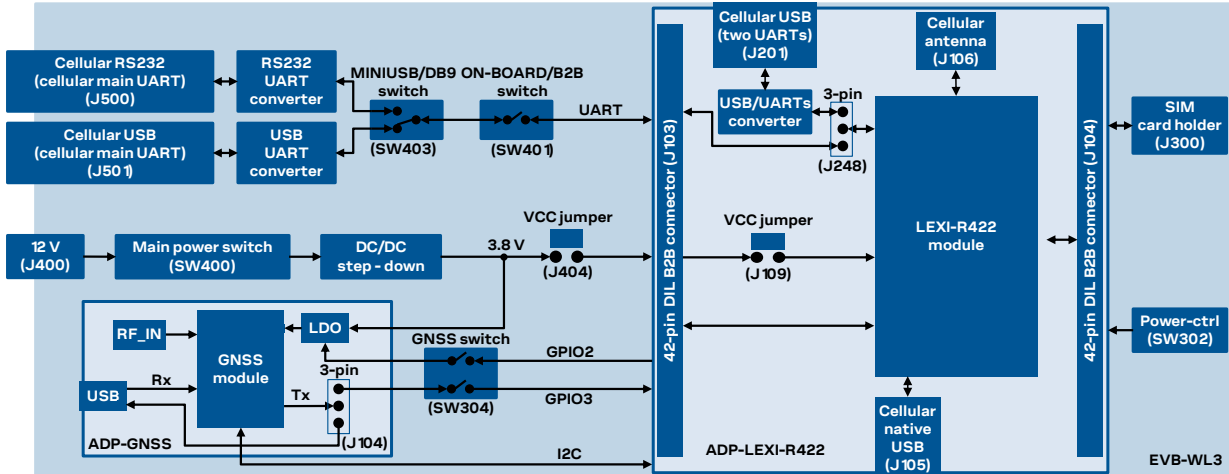

Figure 6: Block diagram of EVK-LEXI-R422

The ADP-LEXI-R422 and the ADP-GNSS are connected by male header board-to-board connectors on the bottom of the adapter boards and their corresponding female connectors on top of the EVB-WL3.

As also illustrated in section 2.1.3 and summarized in Table 1, for communication via the UART interfaces of the cellular module, the following connections are allowed and can be alternatively enabled in a mutually exclusive way:

1. If the ON-BOARD / B2B switch (SW401) on the EVB-WL3 board is set to “ON-BOARD” and if a jumper socket is inserted on the pin 1 and pin 2 of the 3-pin header J248 on the cellular adapter board (see Figure 7), then the main UART interface of the LEXI-R422 module, routed through the DIL header board-to-board connectors mounted on the bottom of the cellular adapter board, can be accessed as converted to USB interface on the USB connector (J501) on the EVB-WL3 board, or it can be accessed as converted to RS232 interface on the RS232 DB9 connector (J500) on the EVB-WL3 board, according to the MINIUSB / DB9 switch (SW403) setting.
2. If the ON-BOARD / B2B switch (SW401) on the EVB-WL3 board is set to “B2B” and if a jumper socket is inserted on the pin 2 and pin 3 of the 3-pin header J248 on the cellular adapter board (see Figure 7), the UART interfaces of LEXI-R422 module can be accessed as USB interfaces on the USB connector (J201) on the cellular adapter board.
3. If the ON-BOARD / B2B switch (SW401) on the EVB-WL3 board is set to “B2B” and if there is no jumper socket inserted on the 3-pin header J248 on the cellular adapter board (see Figure 7), then the UART interface(s) of the LEXI-R422 module can be accessed at 1.8 V CMOS signal levels on the DIL header connector mounted on the top of the cellular adapter board, to communicate, for example, with an external MCU.

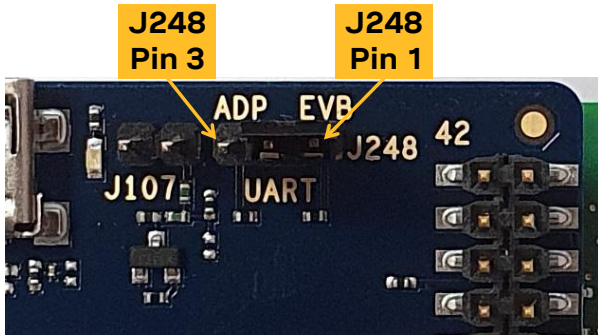

Figure 7: 3-pin header J248 available to set the routing of the UART interfaces

The USB interface of the cellular module (available for diagnostic purpose only) is available on the native USB connector (J105) mounted on the cellular adapter board.

Other LEXI-R422 peripherals are available on the dual-in-line male board-to-board connectors (J103 and J104) provided on the top layer of the cellular adapter board.

The lower board (EVB-WL3) is also designed to be used with other u-blox cellular adapter boards. It contains additional switches, jumpers, connectors, LEDs and parts that may be only partially described in this document, because they are intended for use only with other u-blox cellular modules. It is recommended to leave any additional connector unconnected and any additional switch in its default configuration.

5.2 Switches, jumpers and buttons

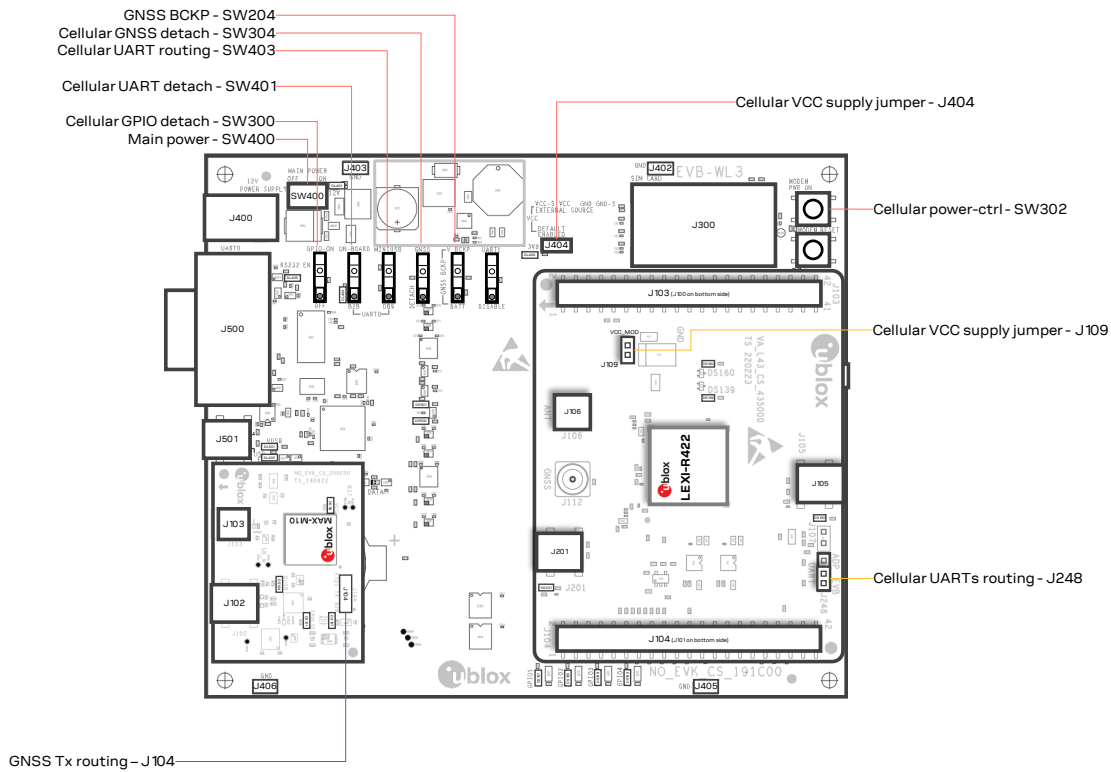

Function	Description	Name	Board
Main power switch	Power on /off the whole evaluation kit	SW400	EVB-WL3
Cellular VCC	Jumper socket to provide the 3.8 V supply to the cellular VCC input	J404	EVB-WL3
		J109	ADP-LEXI-R422
Cellular power-ctrl	Push button to switch on /off / reset LEXI-R422 modules	SW302	EVB-WL3
Cellular UART detach	Slide switch to attach / detach cellular UART from USB / RS232 connectors	SW401	EVB-WL3
Cellular UART routing	Slide switch to select cellular main UART routing on USB or RS232 connector	SW403	EVB-WL3
Cellular UARTs routing	3-pin header jumper to route cellular UART(s) interfaces to the USB two UARTs connector on the ADP-LEXI-R422, or over the USB or RS232 connectors on the EVB-WL3, or over the DIL B2B connector on the ADP-LEXI-R422	J248	ADP-LEXI-R422
Cellular GPIO detach	Slide switch to attach / detach the cellular GPIOs from peripherals: when detached, the signals are available only on DIL B2B connector on ADP-LEXI-R422 board	SW300	EVB-WL3
Cellular GNSS detach	Slide switch to attach / detach the cellular system to the GNSS module mounted on the ADP-GNSS: when detached, signals are available only on DIL B2B connector on ADP-LEXI-R422 board	SW304	EVB-WL3
GNSS BCKP	Slide switch to connect / disconnect backup battery to V_BCKP pin of the GNSS module mounted on the ADP-GNSS	SW204	EVB-WL3
GNSS Tx routing	3-pin header jumper to route and make accessible GNSS UART Tx over the USB connector on the ADP-GNSS or to use it as Tx data ready for the cellular module	J104	ADP-GNSS

Table 2: EVK-LEXI-R422 switches, jumpers and buttons description

5.3 LEDs

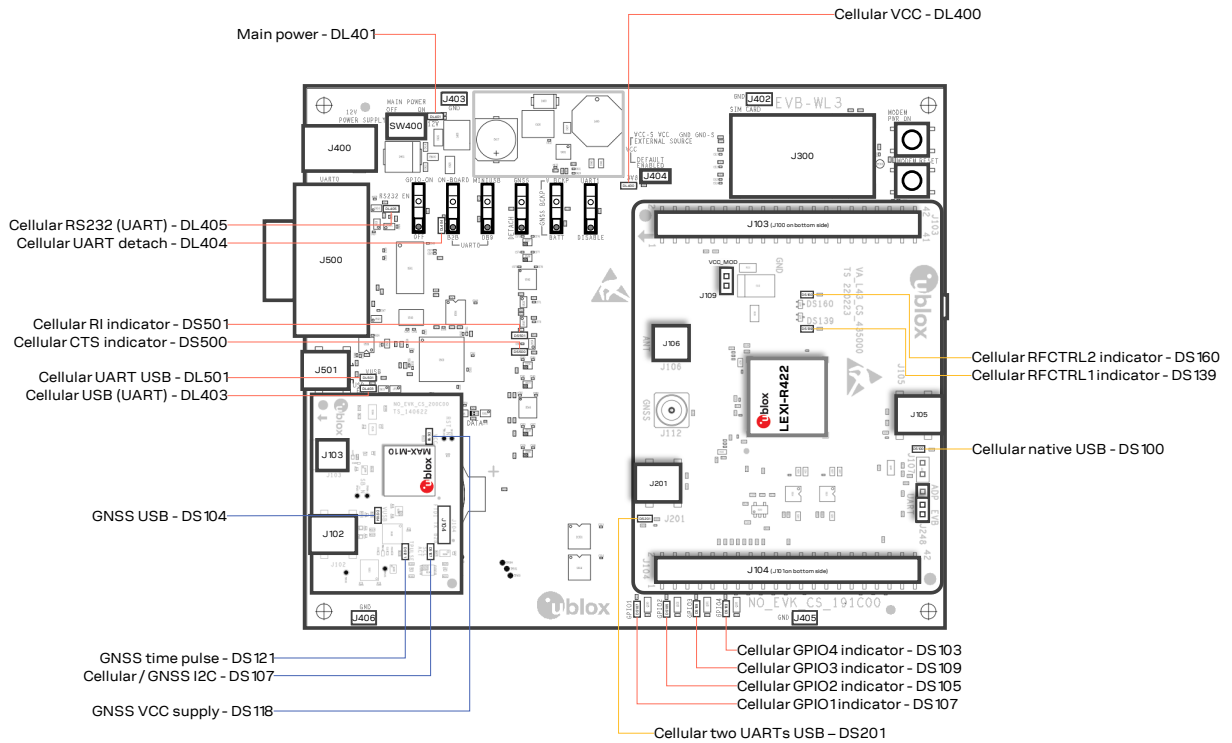

Function	Color	Description	LED #	Board
Main power		Power supply plugged in the 9 - 18 V power input	DL401	EVB-WL3
Cellular VCC		Cellular module supplied; main power switch must be switched on	DL400	EVB-WL3
Cellular UART USB		USB cable plugged in J501 for UART access	DL501	EVB-WL3
Cellular USB (UART)		Green light on when UART is routed to J501 Red light blinks at UART TX or RX data on J501	DL403	EVB-WL3
Cellular UART detach		UART signals are available only on ADP-LEXI-R422	DL404	EVB-WL3
Cellular RS232 (UART)		Green light on when UART is routed to J500 Red light blinks at UART TX or RX data on J500	DL405	EVB-WL3
Cellular RI indicator		RI line turns ON (active low)	DS501	EVB-WL3
Cellular CTS indicator		CTS line turns ON (active low)	DS500	EVB-WL3
Cellular GPIO1 indicator		Green light on when cellular GPIO1 is high	DS107	EVB-WL3
Cellular GPIO2 indicator		Green light on when cellular GPIO2 is high	DS105	EVB-WL3
Cellular GPIO3 indicator		Green light on when cellular GPIO3 is high	DS109	EVB-WL3
Cellular GPIO4 indicator		Green light on when cellular GPIO4 is high	DS103	EVB-WL3
Cellular RFCTRL1 indicator		Green light on when cellular RFCTRL1 is high	DS139	ADP-LEXI-R422
Cellular RFCTRL2 indicator		Red light on when cellular RFCTRL2 is high	DS160	ADP-LEXI-R422
Cellular native USB		USB cable plugged in J105 on ADP-LEXI-R422	DS100	ADP-LEXI-R422
Cellular two UARTs USB		USB cable plugged in J201 on ADP-LEXI-R422	DS201	ADP-LEXI-R422
GNSS VCC supply		MAX-M10S GNSS module supply is turned on	DS118	ADP-GNSS
GNSS USB		USB cable plugged in J102 on ADP-GNSS	DS104	ADP-GNSS
GNSS time pulse		MAX-M10S GNSS time pulse	DS121	ADP-GNSS
Cellular / GNSS I2C		Cellular / GNSS module communication over the I2C interface	DS107	ADP-GNSS

Table 3: EVK-LEXI-R422 LEDs description

5.4 Connectors

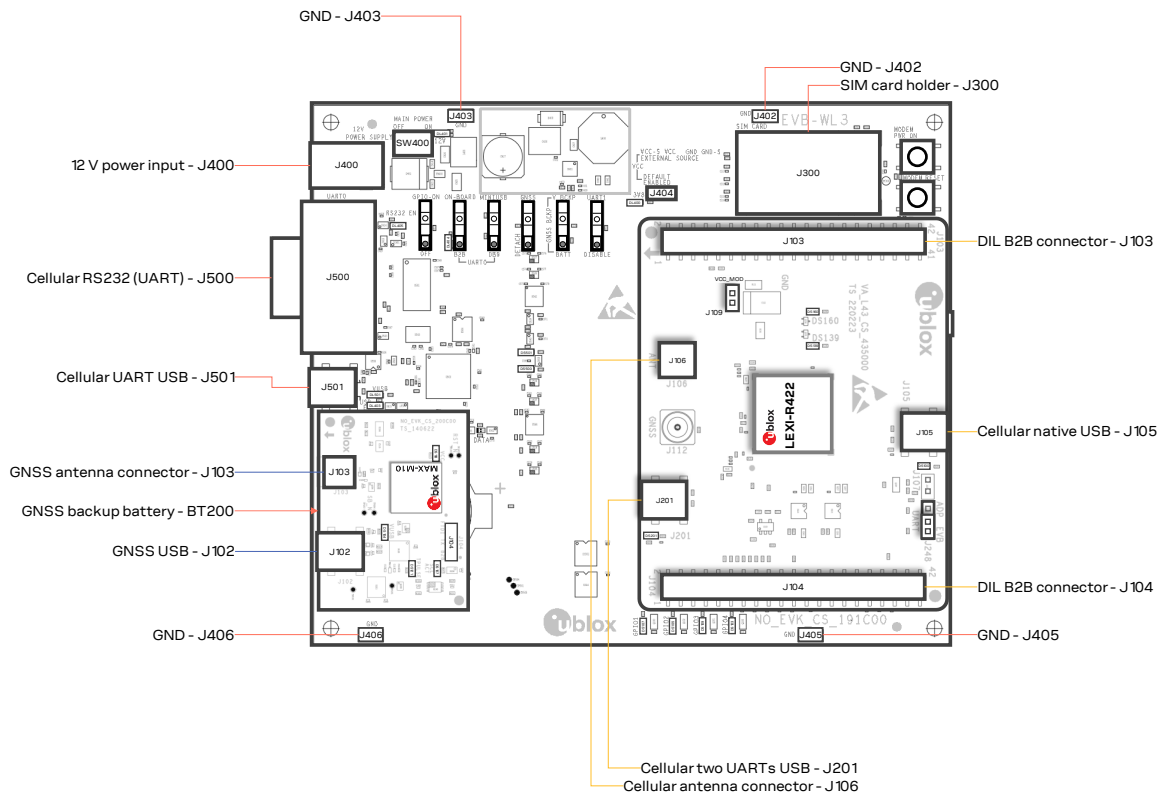

Function	Description	Name	Board	
9 - 18 V power input	Connector for the AC / DC power adapter of EVK AC: 100-240 V, 0.8 A, 50-60 Hz / DC: +12 V, 2.5 A	IEC 60417-5172 Class II equipment	J400	EVB-WL3
SIM card holder	SIM card holder (mini-SIM 2FF)		J300	EVB-WL3
Cellular USB (UART)	Mini-USB connector for the cellular UART interface converted as USB interface		J501	EVB-WL3
Cellular RS232 (UART)	DB9 connector for the cellular UART interface converted as RS232 interface		J500	EVB-WL3
GNSS backup battery	Backup battery socket for the GNSS module (under ADP-GNSS board)		BT200	EVB-WL3
GND	Ground terminals for the probe reference		J402, J403 J405, J406	EVB-WL3
Cellular antenna	SMA connector for the cellular antenna (ANT)		J106	ADP-LEXI-R422
Cellular native USB	Mini-USB connector for the cellular native USB interface		J105	ADP-LEXI-R422
Cellular two UARTs USB	Mini-USB connector for the cellular two UART interfaces converted as USB interfaces		J201	ADP-LEXI-R422
DIL B2B headers	Dual-in-line board-to-board connectors for cellular module interfaces		J103, J104	ADP-LEXI-R422
GNSS antenna	SMA connector for the GNSS antenna to be connected to the GNSS RF input of the MAX-M10S GNSS module (RF_IN)		J103	ADP-GNSS
GNSS USB	Mini-USB connector for the GNSS module UART interface converted as USB interface		J102	ADP-GNSS

Table 4: EVK-LEXI-R422 connectors description

- ⚠ Caution! In the unlikely event of a failure in the internal protection circuitry, there is a risk of an explosion when charging a fully or a partially discharged battery. Replace the battery when it no longer has sufficient charge for unit operation. Check the battery before use if the device has not been used for an extended period.
- ⚠ Caution! Risk of explosion if the battery is replaced with an incorrect type. Dispose battery according to rules!

5.5 EVK-LEXI-R422 pin out

Table 5 lists the interfaces of the LEXI-R422 modules, as routed up to the 42-pin dual-in-line board-to-board connectors (J103 and J104) available on the ADP-LEXI-R422 adapter board of the evaluation kit.

LEXI-R422 module			Connector	LEXI-R422 module			Connector
Pin no.	Pin ID	Signal name	Name / pin number	Pin no.	Pin ID	Signal name	Name / pin number
1	B1	GND	J104 pins 7-10	27	P15	PWR_CTRL	J104 pin 30
2	C1	RSVD	Not available	28	N15	RSVD	J103 pin 25
3	D1	GND	J104 pins 7-10	29	M15	GPIO6	J104 pin 24
4	E1	RXD	J104 pin 15	30	L15	SIM_RST	J103 pin 15
5	F1	TXD	J104 pin 16	31	K15	SIM_CLK	J103 pin 16
6	G1	CTS	J104 pin 13	32	J15	SIM_IO	J103 pin 13
7	H1	RTS	J104 pin 14	33	H15	VSIM	J103 pin 14
8	J1	DCD	J104 pin 12	34	G15	RSVD	Not available
9	K1	DTR	J104 pin 11	35	F15	RSVD	Not available
10	L1	RI	J104 pin 18	36	E15	RSVD	Not available
11	M1	DSR	J104 pin 17	37	D15	RSVD	Not available
12	N1	SCL	J103 pin 19	38	C15	RSVD	Not available
13	P1	SDA	J103 pin 22	39	B15	RSVD	Not available
14	R2	GPIO1	J104 pin 34	40	A14	VCC	J103 pins 7-10
15	R3	GPIO2	J104 pin 32	41	A13	VCC	J103 pins 7-10
16	R4	GPIO3	J104 pin 31	42	A12	VCC	J103 pins 7-10
17	R5	GPIO4	J104 pin 26	43	A11	V_INT	J104 pin 35
18	R6	GPIO5	J104 pin 23	44	A10	RFCTRL2	J103 pin 6
19	R7	USB_3V3	J104 pin 4	45	A9	RFCTRL1	J103 pin 5
20	R8	USB_D-	Not available	46	A8	RSVD	J103 pin 4
21	R9	USB_D+	Not available	47	A7	RSVD	J104 pin 22
22	R10	USB_5V0	Not available	48	A6	RSVD	Not available
23	R11	RSVD	J103 pin 26	49	A5	ANT_DET	Not available
24	R12	RSVD	J103 pin 21	50	A4	GND	J104 pins 7-10
25	R13	RSVD	J103 pin 23	51	A3	ANT	Not available
26	R14	RSVD	J103 pin 24	52	A2	GND	J104 pins 7-10

Table 5: Interfaces of LEXI-R422 modules

Dual-in-line board-to-board connector J104				Dual-in-line board-to-board connector J103			
Signal name	Pin no.	Pin no.	Signal name	Signal name	Pin no.	Pin no.	Signal name
Not connected	1	2	GND	Not connected	1	2	GND
Not connected	3	4	USB_3V3	Not connected	3	4	RSVD #46
Not connected	5	6	Not connected	RFCTRL1	5	6	RFCTRL2
GND	7	8	GND	VCC	7	8	VCC
GND	9	10	GND	VCC	9	10	VCC
DTR	11	12	DCD	Not connected	11	12	Not connected
CTS	13	14	RTS	SIM_IO	13	14	VSIM
RXD	15	16	TXD	SIM_RST	15	16	SIM_CLK
DSR	17	18	RI	Not connected	17	18	Not connected
Not connected	19	20	Not connected	SCL	19	20	Not connected
Not connected	21	22	RSVD #47	RSVD #24	21	22	SDA
GPIO5	23	24	GPIO6	RSVD #25	23	24	RSVD #26
Not connected	25	26	GPIO4	RSVD #28	25	26	RSVD #23
Not connected	27	28	Not connected	Not connected	27	28	Not connected
Not connected	29	30	PWR_CTRL	Not connected	29	30	Not connected
GPIO3	31	32	GPIO2	Not connected	31	32	Not connected
RSVD #99	33	34	GPIO1	Not connected	33	34	Not connected
V_INT	35	36	Not connected	Not connected	35	36	Not connected
Not connected	37	38	Not connected	Not connected	37	38	Not connected
Not connected	39	40	Not connected	Not connected	39	40	Not connected
GND	41	42	Not connected	GND	41	42	Not connected

Table 6: Pin-out of the 42-pin dual-in-line board-to-board connectors (J103, J104)

 The pins / interfaces that are not supported by LEXI-R422 modules should be not driven by an external device. See the LEXI-R422 data sheet [2] and the LEXI-R422 system integration manual [3] to learn about the features supported by LEXI-R422 module.

5.6 Current consumption measurement

To measure the current consumption of LEXI-R422 modules, remove the jumper socket from the cellular VCC supply jumper **J109** on the ADP-LEXI-R422 board, as shown in [Figure 8](#).

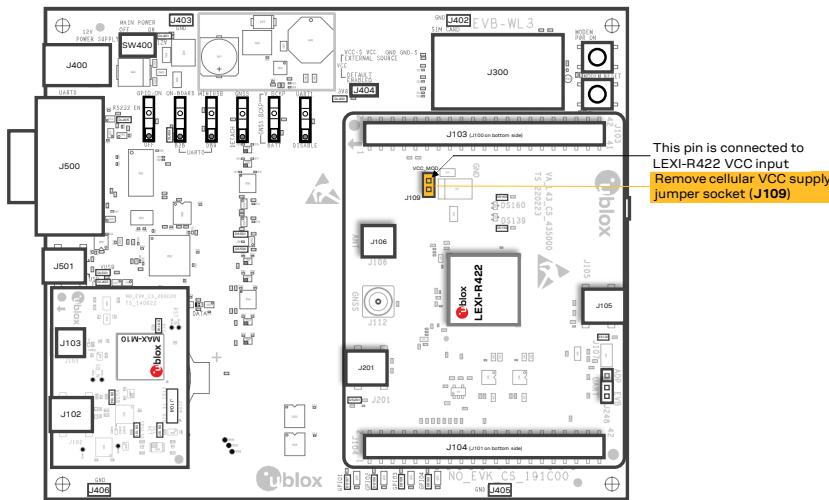

Figure 8: Jumper socket to be removed for LEXI-R422 module's current consumption measurement

A suitable external digital multi-meter (as the Keysight 34465A, 34410A or 34411A) can be used for current consumption measurements: in this example, the 3.8 V supply circuit on the EVB-WL3 will supply the cellular module, with the digital multi-meter placed in series as illustrated in [Figure 9](#).

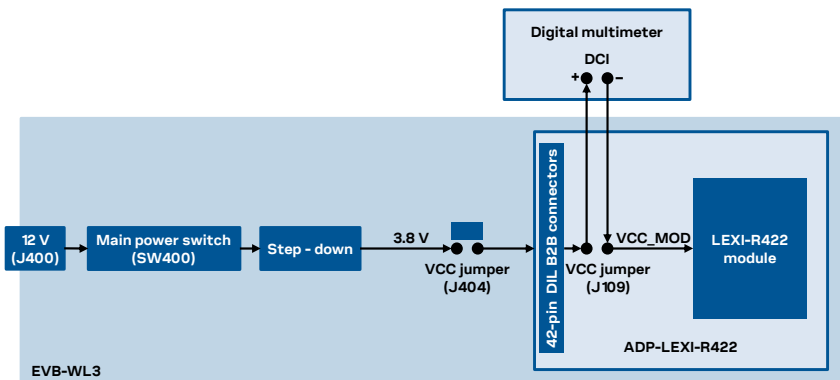

Figure 9: Setup for cellular module's current consumption measurement using a current meter

Alternatively, a suitable external DC power supply with dynamic current measurement capabilities (e.g., the portable and cheap Qoitech Otii Arc, or the more accurate Keysight N6705B, or the models designed for mobile communications Keysight 66319B/D or 66321B/D) can be used, acting also as 3.8 V supply source for the cellular module mounted on the adapter board, as illustrated in [Figure 10](#).

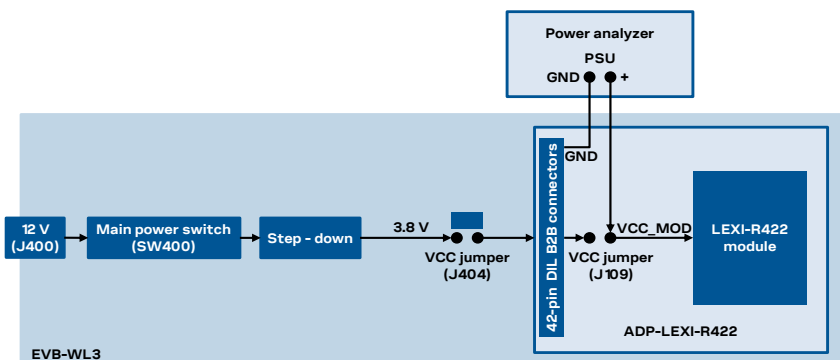

Figure 10: Setup for cellular module's current consumption measurement using a DC power analyzer

Appendix

A Setting up AT terminal communication

The u-blox m-center cellular module evaluation tool is a powerful platform for evaluating, configuring and testing u-blox cellular products. m-center includes an AT commands terminal for communication with the device and can be downloaded for free from www.u-blox.com. For m-center example scripts, visit <https://github.com/u-blox/m-center>.

1. Follow the board setup instructions in section 2 to provide all the required connections and switching on the cellular module.
2. Run the u-blox m-center tool: after the m-center start-up, the **Home** page appears, as shown in Figure 11.

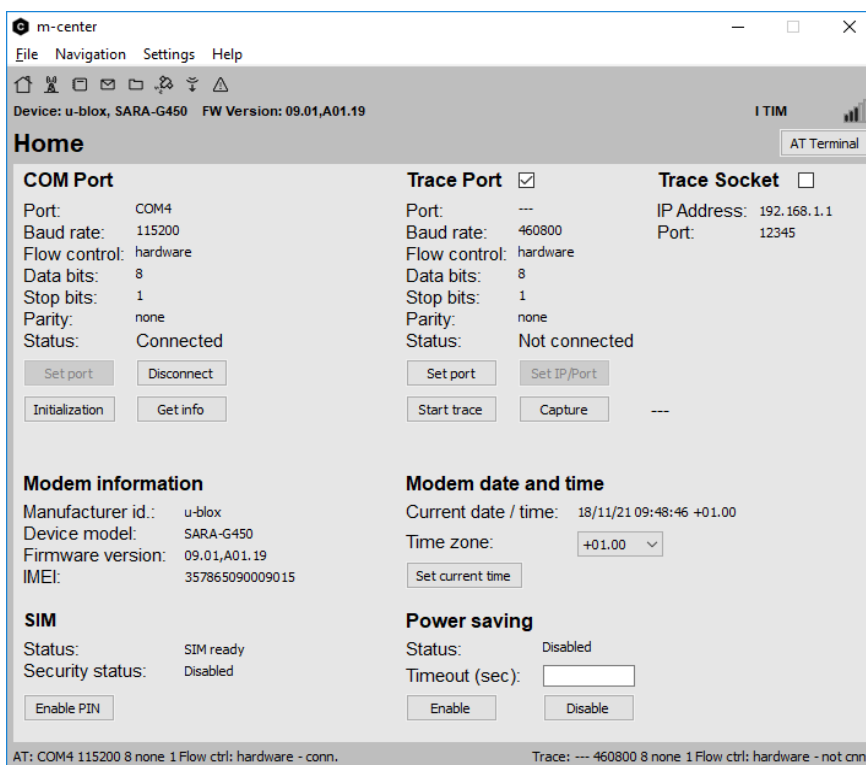

Figure 11: m-center Home page

3. On the **Home** page, set up the AT COM port with setting values below:
 - o Data rate: 115200 bit/s
 - o Data bits: 8
 - o Parity: N
 - o Stop bits: 1
 - o Flow control: HW
4. Check in the Windows Device Manager to find out which specific COM port is being used by the EVK-LEXI-R422.
5. Enable the connection to u-blox cellular module by clicking on the **Connect** button.
6. Retrieve the module and network information by clicking on the **Get info** button.
7. The module information is retrieved and displayed on the **Home** page.

- Click on the **AT Terminal** button, found at the upper right of the **Home** page. A new window opens, and the AT command terminal is now ready for communication with the EVK-LEXI-R422.

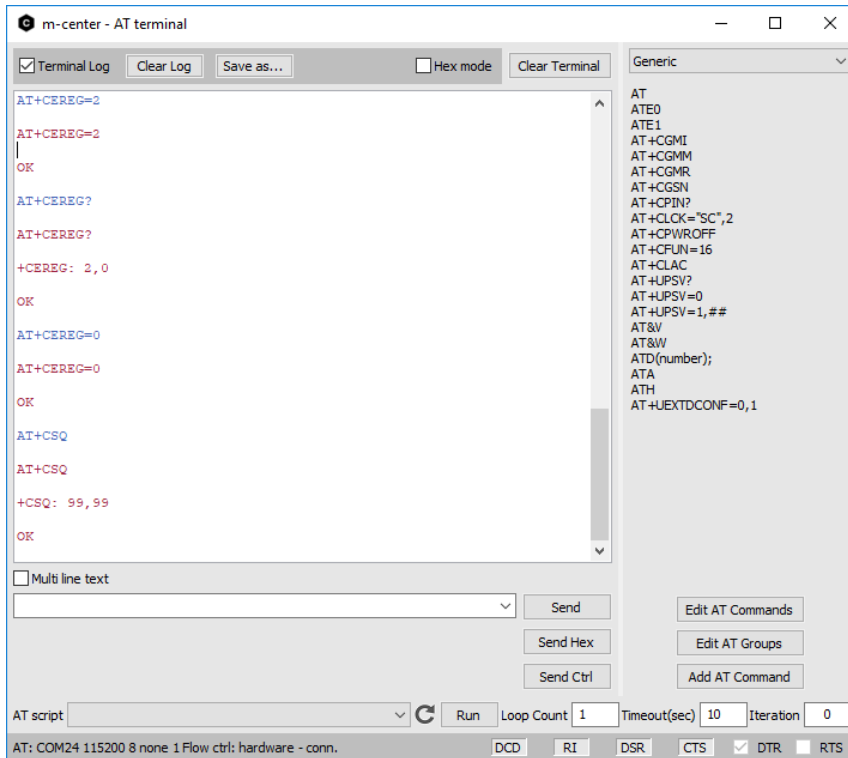

Figure 12: AT terminal window

- The AT terminal is ready to use.

For more information on using the u-blox m-center, press the **F1** key to open the m-center help window on the computer.

For the complete list of the AT commands supported by the modules and their syntax, see the AT commands manual [1].

B Glossary

Abbreviation	Definition
AC	Alternating current
ADP	Adapter Board
APN	Access Point Name
AT	AT Command Interpreter Software Subsystem, or attention
B2B	Board-To-Board
CTS	Clear To Send
DC	Direct current
DCD	Data Carrier Detect
DCE	Data Communication Equipment
DIL	Dual In Line
DSR	Data Set Ready
DTE	Data Terminal Equipment
DTR	Data Terminal Ready
EGPRS	Enhanced General Packet Radio Service
EVB	Evaluation Board
EVK	Evaluation Kit
GND	Ground
GNSS	Global Navigation Satellite System
GPIO	General Purpose Input Output
HW	Hardware
I2C	Inter-Integrated Circuit
IoT	Internet of Things
IP	Internet Protocol
LED	Light Emitting Diode
LTE	Long Term Evolution
NB	Narrow Band
PDP	Packet Data Protocol
PSU	Power Supply Unit
RAT	Radio Access Technology
RF	Radio Frequency
RI	Ring Indicator
RTS	Request To Send
Rx	Receiver
SIM	Subscriber Identity Module
SMA	SubMiniature version A
TCP	Transfer Control Protocol
Tx	Transmitter
UART	Universal Asynchronous Receiver-Transmitter serial interface
USB	Universal Serial Bus

C Conformity notice

The equipment is intended for indoor usage. It is the user's duty to verify if further restrictions apply, such as in airplanes, hospitals, or hazardous locations (petrol stations, refineries...). Any changes or modification made to this equipment will void its compliance to the safety requirements.

Maintenance, inspections and/or repairs of the EVK-LEXI-R422 shall be performed by u-blox AG.

Related documentation

- [1] u-blox SARA-R42 / LEXI-R422 AT commands Manual, [UBX-17003787](#)
- [2] u-blox LEXI-R422 data sheet, [UBX-22020834](#)
- [3] u-blox LEXI-R422 system integration manual, [UBX-23007449](#)
- [4] u-blox SARA-R42 / LEXI-R422 application development guide, [UBX-20050829](#)

All these documents are available on our website (<http://www.u-blox.com>).

 For regular updates to u-blox documentation and to receive product change notifications, register on our homepage (www.u-blox.com).

Revision history

Revision	Date	Name	Comments
R01	30-Jun-2023	fvid	Initial release.
R02	06-Oct-2023	yatu	Minor clarifications.

Contact

u-blox AG

Address: Zürcherstrasse 68
8800 Thalwil
Switzerland

For further support and contact information, visit us at www.u-blox.com/support.

X-ON Electronics

Largest Supplier of Electrical and Electronic Components

Click to view similar products for [Mobile Development Tools](#) category:

Click to view products by [U-Blox](#) manufacturer:

Other Similar products are found below :

[5G-SOC-EVB-KIT](#) [MIKROE-5124](#) [EVK-R422M8S-0](#) [76002147](#) [ADP-SARA-R500E-01](#) [6000648](#) [6001457](#) [MIKROE-2535](#) [1946](#) [1963](#)
[2687](#) [2691](#) [XK3-C-G1-UT-W](#) [XK3-C-G4-UT-W](#) [XK3-C-GM2-UT-W](#) [MIKROE-4118](#) [MIKROE-1298](#) [MIKROE-1375](#) [MIKROE-1720](#)
[MIKROE-3294](#) [MIKROE-4506](#) [MIKROE-5991](#) [MIKROE-6256](#) [MIKROE-6277](#) [MIKROE-6318](#) [EG800QEULC-N03-TA0AA](#) [109030001](#)
[109030002](#) [Monarch 2 NEKTAR-B-GM02S](#) [Monarch 2 NEKTAR-B-GM02SP](#) [Monarch-Go-STK](#) [Monarch-Go-GPS-STK](#) [6001458](#)
[SKY68001-31EK1](#) [CEL-13120](#) [CEL-14997](#) [KIT-21229](#) [WRL-20409](#) [ADP-LEXI-R520-02](#) [ADP-R10801D-00](#) [ADP-R8001-00C](#) [ADP-](#)
[R8001M10-00C](#) [ADP-SARA-R520-02](#) [ADP-SARA-R520M10-02](#) [ADP-LEXI-R422-01](#) [EVK-LEXI-R422-01](#) [EVK-R10801D-00](#) [EVK-](#)
[R422M10S-0](#) [EVK-R8001-00C](#) [EVK-R8001M10-00C](#)