

EVK-N2

SARA-N2 series Cellular Evaluation Kits

User Guide

Abstract

This guide explains how to set up the EVK-N2 Evaluation Kits to begin evaluating the u-blox SARA-N2 series cellular modules supporting LTE Cat NB1 radio access technology.



Document Information

Title	EVK-N2	
Subtitle	SARA-N2 series Cellular Evaluation Kits	
Document type	User Guide	
Document number	UBX-17005115	
Revision, date	R03	09-Oct-2017
Disclosure restriction		

This document applies to the following products:

Name	Type number	Modem version	Application version	PCN reference	Product status
EVK-N200	EVK-N200-02B-00	06.57	A02.02	UBX-17056257	Engineering Samples
EVK-N201	EVK-N201-02B-00	06.57	A02.02	UBX-17056257	Engineering Samples
EVK-N210	EVK-N210-02B-00	06.57	A02.02	UBX-17056257	Engineering Samples
EVK-N211	EVK-N211-02B-00	06.57	A02.02	UBX-17056257	Engineering Samples
EVK-N280	EVK-N280-02B-00	06.57	A02.02	UBX-17056257	Engineering Samples

u-blox reserves all rights to this document and the information contained herein. Products, names, logos and designs described herein may in whole or in part be subject to intellectual property rights. Reproduction, use, modification or disclosure to third parties of this document or any part thereof without the express permission of u-blox is strictly prohibited.

The information contained herein is provided "as is" and u-blox assumes no liability for the use of the information. No warranty, either express or implied, is given, including but not limited, with respect to the accuracy, correctness, reliability and fitness for a particular purpose of the information. This document may be revised by u-blox at any time. For most recent documents, visit www.u-blox.com.

Copyright © 2017, u-blox AG

u-blox is a registered trademark of u-blox Holding AG in the EU and other countries.

Trademark Notice

Microsoft and Windows are either registered trademarks or trademarks of Microsoft Corporation in the United States and/or other countries. All other registered trademarks or trademarks mentioned in this document are property of their respective owners.

Contents

Contents.....	3
1 Starting up.....	4
1.1 EVK-N2 overview.....	4
1.2 EVK-N2 block diagram.....	5
1.3 Switches, jumpers and buttons.....	6
1.4 LEDs.....	6
1.5 Connectors.....	7
1.6 EVK-N2 pin out.....	8
1.7 Software installation.....	9
1.8 Board setup.....	10
Appendix	12
A Setting up AT terminal applications for communication with EVK-N2	12
B AT commands examples	13
C Current consumption measurement	14
Declaration of conformities.....	15
Related documents	15
Revision history.....	15
Contact.....	16

1 Starting up

1.1 EVK-N2 overview

The EVK-N2 evaluation kits are powerful and easy-to-use tools that simplify the evaluation of u-blox SARA-N2 series Narrow Band Internet of Things (NB-IoT) modules.

The following evaluation kits are available with u-blox SARA-N2 cellular modules:

- EVK-N200 evaluation kit is for evaluation of SARA-N200
- EVK-N201 evaluation kit is for evaluation of SARA-N201
- EVK-N210 evaluation kit is for evaluation of SARA-N210
- EVK-N211 evaluation kit is for evaluation of SARA-N211
- EVK-N280 evaluation kit is for evaluation of SARA-N280

The evaluation kits EVK-N200, EVK-N201, EVK-N210, EVK-N211, and EVK-N280 are herein identified as EVK-N2.

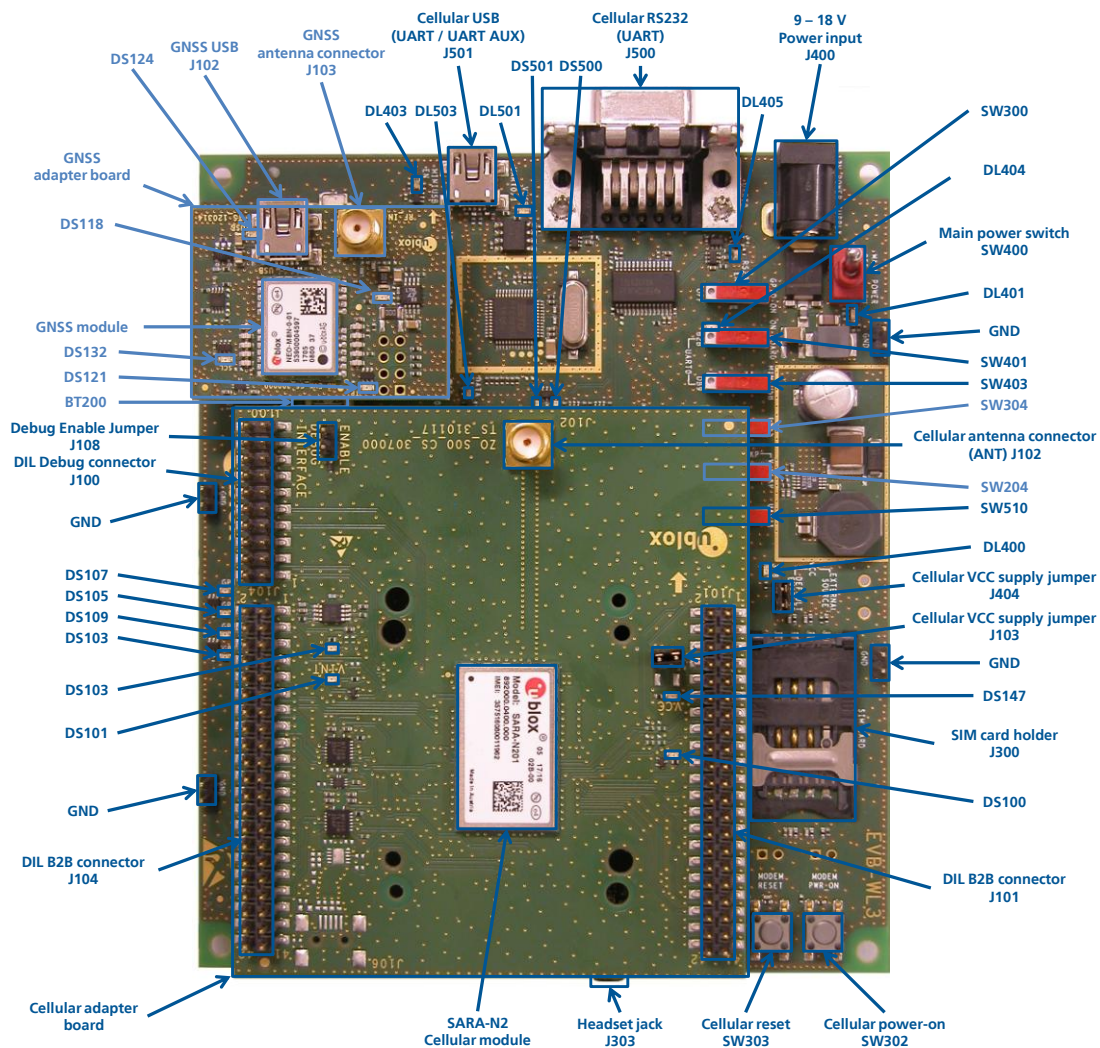

Figure 1: Overview of EVK-N2 evaluation kit for SARA-N2 modules

1.2 EVK-N2 block diagram

Figure 2 shows the main interfaces and internal connections of the EVK-N2 evaluation kit:

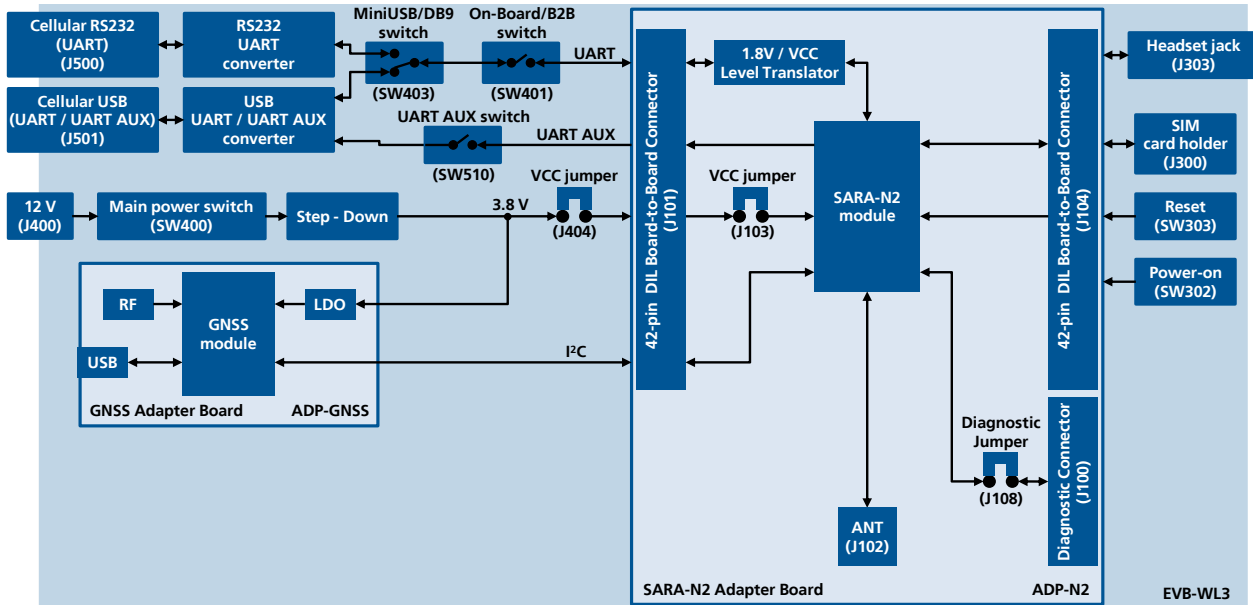

Figure 2: Block diagram of EVK-N2 for SARA-N2 series modules

The EVK-N2 evaluation kit is formed by three boards:

- The lower one, called EVB-WL3, contains the power supply and other peripherals for the SARA-N2 module (e.g. SIM card holder and Reset button).
- The cellular adapter board, called ADP-N2, contains the SARA-N2 module, the cellular antenna connector and the DIL connectors (J100, J101 and J104).
- The GNSS adapter board, called ADP-GNSS, contains the u-blox GNSS module, the GNSS antenna connector and the USB connector for the GNSS module.

The boards are connected by means of male header board-to-board connectors provided on the bottom of the adapter boards and their corresponding female connectors provided on top of the lower board.

The SARA-N2 series pins are available on the Dual-In-Line male Board-to-Board connectors provided on the top layer of the cellular Adapter Board (J101 and J104), which are pin-to-pin compatible to the connectors on the bottom layer of the adapter board EVB-WL3.

The DIL connector J100, mounted on the ADP-N2, is available for diagnostic purpose.

Communication with the SARA-N2 module is provided through the Cellular RS232 DB9 connector (J500) or the Cellular USB Mini-USB connector (J501), available on the EVB-WL3 board. The UART interface of the SARA-N2 module is routed up to both connectors J500 and J501. The Mini-USB / DB9 slide switch (SW403) must be set according to the selected connector. The Cellular USB Mini-USB connector (J501) provides also access to the secondary / auxiliary UART interface of the SARA-N2 module (see section 1.8).

The lower board (EVB-WL3) is designed also to be used with other u-blox cellular adapter boards. It contains additional switches, jumpers, connectors, LEDs and parts that are partially described in Figure 1 or in this document, because they are intended for use only with other u-blox cellular modules. It is recommended to leave any additional connector unconnected and any additional switch in its default configuration.

1.3 Switches, jumpers and buttons

Function	Description	Name	Board
Main Power Switch	Power on / off of the whole evaluation kit	SW400	EVB-WL3
Cellular VCC Jumper	Jumper socket to provide the 3.8 V supply to the cellular module VCC input	J404	EVB-WL3
		J103	ADP-N2
Diagnostic Jumper	Jumper socket for diagnostic purpose (leave unconnected)	J108	ADP-N2
Cellular Power-on	Push button (unconnected, as not supported by SARA-N2 series)	SW302	EVB-WL3
Cellular Reset	Push button to reset the cellular module	SW303	EVB-WL3
Cellular UART detach	Slide switch to attach / detach cellular module UART from USB / RS232 connectors: when detached, UART signals are available only on DIL B2B connectors on ADP board	SW401	EVB-WL3
Cellular UART routing	Slide switch to select cellular module UART routing on USB or on RS232 connectors	SW403	EVB-WL3
Cellular UART AUX detach	Slide switch to attach / detach cellular module UART AUX from USB connector: when detached, UART AUX signals available only on the DIL B2B connector on ADP board	SW510	EVB-WL3
Cellular GPIO detach	Slide switch to attach / detach the cellular module GPIOs from peripherals: when detached, the signals are available only on the DIL B2B connectors on ADP board	SW300	EVB-WL3
Cellular GNSS detach	Slide switch to attach / detach the cellular module to the GNSS module (GPIO2): when detached, the signals are available only on DIL B2B connector on ADP board	SW304	EVB-WL3
GNSS V_BCKP	Slide switch to connect / disconnect backup battery to V_BCKP pin of GNSS module	SW204	EVB-WL3

Table 1: EVK-N2 switches, jumpers and buttons' description

1.4 LEDs

















Function	Description	LED #	Board	Color
Main Power	Power supply plugged in the 9 - 18 V Power Input	DL401	EVB-WL3	
Cellular VCC	Cellular module supplied. Main Power Switch must be switched on	DL400	EVB-WL3	
		DS147	ADP-N2	
Cellular USB	USB cable plugged in Cellular USB connector for UART / UART AUX access	DL501	EVB-WL3	
Cellular USB / UART	Green light is activated when UART is routed to Cellular USB connector Red light blinks at UART TX or RX data on Cellular USB connector	DL403	EVB-WL3	
Cellular UART detach	UART signals are available only on the DIL B2B connector on ADP board	DL404	EVB-WL3	
Cellular RS232 / UART	Green light is activated when UART is routed to Cellular RS232 connector Red light blinks at UART TX or RX data on Cellular RS232 connector	DL405	EVB-WL3	
Cellular USB / UART AUX	Green light is activated when UART AUX is routed to Cellular USB connector Red light blinks at UART AUX data on Cellular USB connector	DL503	EVB-WL3	
Cellular CTS indicator	Green light is activated when CTS line turns ON (active low)	DS500	EVB-WL3	
Cellular GPIO1 indicator	Green light is activated when SARA-N2 GPIO1 is high	DS107	EVB-WL3	
Cellular GPIO3 indicator	Green light is activated when SARA-N2 GPIO2 is high	DS109	EVB-WL3	
SIM supply	Green light is activated when the VSIM line is at a "high" level	DS100	ADP-N2	
V_INT supply	Green light is activated when the V_INT line is at a "high" level	DS101	ADP-N2	
GNSS VCC supply	GNSS module supply is turned ON	DS118	ADP-GNSS	
GNSS USB	USB cable plugged in GNSS USB connector	DS124	ADP-GNSS	
GNSS Timepulse	Pulses at 1 Hz when valid GNSS fix	DS121	ADP-GNSS	
Cellular / GNSS DDC	Cellular / GNSS module communication over DDC (I ² C) interface	DS132	ADP-GNSS	

Table 2: EVK-N2 LEDs' description

1.5 Connectors



Function	Description		Name	Board	
9 - 18 V Power Input	Connector for the AC / DC power adapter of the EVK AC: 100-240 V, 0.8 A, 50-60 Hz / DC: +12 V, 2.5 A		IEC 60417-5172 Class II equipment	J400	EVB-WL3
SIM card holder	SIM card holder			J300	EVB-WL3
Cellular antenna	SMA connector for the module cellular antenna ANT			J102	ADP-N2
Cellular USB (UART)	Mini USB connector for cellular module UART interfaces converted as USB interface			J501	EVB-WL3
Cellular RS232 (UART)	DB9 connector for cellular module primary UART interface converted as RS232 interface			J500	EVB-WL3
DIL B2B headers	Dual-In-Line Board-to-Board connectors for cellular module interfaces			J101-J104	ADP-N2
DIL diagnostic header	Dual-In-Line connector for diagnostic purpose			J100	ADP-N2
Cellular headset	Audio headset jack connector (not supported by SARA-N2 series)			J303	EVB-WL3
GNSS antenna	SMA connector for the GNSS module antenna (GNSS Antenna)			J103	ADP-GNSS
GNSS USB	Mini USB connector for GNSS module USB interface			J102	ADP-GNSS
GNSS backup battery	Backup battery socket for the GNSS module (under GNSS adapter board)			BT200	EVB-WL3
GND	Ground terminals for probe reference			J402, J403 J405, J406	EVB-WL3

Table 3: Description of EVK-N2 connectors

-  **CAUTION! IN THE UNLIKELY EVENT OF A FAILURE IN THE INTERNAL PROTECTION CIRCUITRY THERE IS A RISK OF AN EXPLOSION WHEN CHARGING FULLY OR PARTIALLY DISCHARGED BATTERY. REPLACE BATTERY WHEN IT NO LONGER HAS SUFFICIENT CHARGE FOR UNIT OPERATION. CONTROL THE BATTERY BEFORE USE IF THE DEVICE HAS NOT BEEN USED FOR AN EXTENDED PERIOD OF TIME.**
-  **CAUTION! RISK OF EXPLOSION IF BATTERY IS REPLACED WITH AN INCORRECT TYPE. DISPOSE OF USED BATTERIES ACCORDING TO THE INSTRUCTIONS!**

1.6 EVK-N2 pin out

SARA-N2 module		DIL B2B Connector	SARA-N2 module		DIL B2B Connector
Pin N°	Signal Name	Name / Pin N°	Pin N°	Signal Name	Name / Pin N°
1	GND	J104 Pins 7-10	33	RSVD	Not present
2	RSVD	J104 Pin 3	34	RSVD	Not present
3	GND	J104 Pins 7-10	35	RSVD	Not present
4	V_INT	Not present	36	RSVD	Not present
5	GND	J104 Pins 7-10	37	RSVD	Not present
6	RSVD	Not present	38	SIM_CLK	J101 Pin 15
7	RSVD	Not present	39	SIM_IO	J101 Pin 14
8	RSVD	Not present	40	SIM_RST	J101 Pin 16
9	RSVD	Not present	41	VSIM	J101 Pin 13
10	RTS	J104 Pin 13 ¹	42	RSVD	Not present
11	CTS	J104 Pin 14 ¹	43	GND	J104 Pins 7-10
12	TXD	J104 Pin 15 ¹	44	RSVD	Not present
13	RXD	J104 Pin 16 ¹	45	RSVD	Not present
14	GND	J104 Pins 7-10	46	RSVD	Not present
15	RSVD	Not present	47	RSVD	Not present
16	GPIO1	J104 Pin 20 & 33	48	RSVD	Not present
17	RSVD	Not present	49	RSVD	Not present
18	RESET_N	Not present	50	GND	J104 Pins 7-10
19	RSVD	Not present	51	VCC	J101 Pins 7-10
20	GND	J104 Pins 7-10	52	VCC	J101 Pins 7-10
21	GND	J104 Pins 7-10	53	VCC	J101 Pins 7-10
22	GND	J104 Pins 7-10	54	GND	J104 Pins 7-10
23	RSVD	J104 Pin 31	55	GND	J104 Pins 7-10
24	GPIO2	J104 Pin 19 & 32	56	ANT	Not present
25	RSVD	J104 Pin 25	57	GND	J104 Pins 7-10
26	SDA	J101 Pin 21	58	GND	J104 Pins 7-10
27	SCL	J101 Pin 20	59	GND	J104 Pins 7-10
28	RSVD	Not present	60	GND	J104 Pins 7-10
29	RSVD	Not present	61	GND	J104 Pins 7-10
30	GND	J104 Pins 7-10	62	ANT_DET	Not present
31	RSVD	Not present	63	GND	J104 Pins 7-10
32	GND	J104 Pins 7-10	64	GND	J104 Pins 7-10

Table 4: Interfaces of the SARA-N2 series module, as routed on the 42-pin Dual-In-Line Board-to-Board connectors (J101, J104) available on the ADP-N2 adapter board of the EVK-N2 evaluation kit

¹ The SARA-N2 signal, working at VCC voltage level, is translated at 1.8 V voltage level on the DIL B2B connector

Dual-In-Line Board-to-Board connector J104				Dual-In-Line Board-to-Board connector J101			
Signal Name	Pin N°	Pin N°	Signal Name	Signal Name	Pin N°	Pin N°	Signal Name
Not connected	2	1	GND	Not connected	2	1	GND
Not connected	4	3	Reserved_2	Not connected	4	3	Not connected
Not connected	6	5	Not connected	Not connected	6	5	Not connected
GND	8	7	GND	VCC	8	7	VCC
GND	10	9	GND	VCC	10	9	VCC
Not connected	12	11	Not connected	Not connected	12	11	Not connected
CTS ¹	14	13	RTS ¹	SIM_IO	14	13	VSIM
RXD ¹	16	15	TXD ¹	SIM_RST	16	15	SIM_CLK
Not connected	18	17	Not connected	Not connected	18	17	Not connected
GPIO1	20	19	GPIO2	SCL	20	19	Not connected
Not connected	22	21	Not connected	Not connected	22	21	SDA
Not connected	24	23	Not connected	Not connected	24	23	Not connected
Not connected	26	25	Reserved_25	RESET_N	26	25	Not connected
Not connected	28	27	Not connected	Not connected	28	27	Not connected
Not connected	30	29	Not connected	Not connected	30	29	Not connected
GPIO2	32	31	Reserved_23	Not connected	32	31	Not connected
Not connected	34	33	GPIO1	Not connected	34	33	Not connected
1V8	36	35	Not connected	Not connected	36	35	Not connected
Not connected	38	37	Not connected	Not connected	38	37	Not connected
Not connected	40	39	Not connected	Not connected	40	39	Not connected
GND	42	41	Not connected	GND	42	41	Not connected

Table 5: Pin-out of the 42-pin Dual-In-Line Board-to-Board connectors (J101 and J104) available on the ADP-N2 adapter board of the EVK-N2 evaluation kit



The pins / interfaces that are not supported by a specific SARA-N2 module product version should be not driven by an external device; see the SARA-N2 series Data Sheet [2] for the list of features supported by each SARA-N2 module product version.

1.7 Software installation

The USB drivers are available with the EVK-N2 evaluation kit package. Executable files can be downloaded from www.u-blox.com/evk-downloads and saved to any location on the computer hard drive. The installation can be started by running the executable file on a computer with the Windows operating system.

1.8 Board setup

1. Insert a SIM card into the **SIM card holder** (J300 on the EVB).
2. Connect a cellular antenna (provided with the evaluation kit) to the **Cellular antenna** SMA connector on the ADP-N2 (ANT, RF input/output for transmission and reception of NB-IoT RF signals)
3. If the GNSS functionality is required, connect the GNSS antenna provided with the evaluation kit to the **GNSS antenna** SMA connector on the ADP-GNSS. Place the GNSS antenna in a location with good sky view.



Interface to the GNSS module is not supported by SARA-N2 series modules.

4. Connect the AC / DC +12 V power adapter provided with the evaluation kit to **9 – 18 V Power Input** connector (J400 on the EVB). LED DL401 lights blue.
5. Be sure to provide a jumper socket on both the **Cellular VCC supply jumpers** (J404 on the EVB, and J103 on the ADP-N2). These jumpers provide the connection from the output of the supply circuit on the EVB board to the VCC input of the module.
6. To enable the board power supply, turn the **Main power switch** (SW400 on the EVB) to the ON position. LEDs DL400 and DS147 light green. The cellular module switches on.
7. For communication via the cellular module's UART interface, the following connections are allowed and can be alternatively enabled in a mutually exclusive way (see Table 6 for slide switches positions and LED status):
 - a. Connect a USB cable to mini USB connector (**Cellular USB**, J501 on EVB), LED DL501 lights blue. In this case, two COM ports are enabled with Windows (the numbering of the COM ports can be seen via the Windows Device Manager):
 - o SARA UART interface is available over the first COM port (for AT commands and data)
 - o SARA secondary / auxiliary UART interface is available over the second COM port (for diagnostic)
 - b. Connect an RS232 cable to DB9 connector (**Cellular RS232**, J500 on EVB)

Type of connections	SW401	SW403	LED
Access to cellular UART over the Cellular USB (UART / UART AUX) mini USB connector (J501)	ON BOARD	MINIUSB	DL403
Access to cellular UART over the Cellular RS232 (UART) DB9 connector (J500)	ON BOARD	DB9	DL405
Access to cellular UART on DIL Board-to-Board connector on the adapter board: cellular UART detached from USB (UART / UART AUX) and RS232 (UART) connectors	B2B	Do not care	DL404

Table 6: Serial interface configuration

Then, beside the specific serial connector used (case a or case b), run an AT terminal application (as for example the u-blox m-center tool) selecting the appropriate AT COM port with these settings:

- o Data rate: 9600 b/s
- o Data bits: 8
- o Parity: N
- o Stop bits: 1
- o Flow control: None

8. It is possible to access SARA-N2 module's secondary / auxiliary UART for diagnostic purpose. To do so:

Connect a USB cable to the mini USB connector (**Cellular USB**, J501 on EVB). LED DL501 lights blue.

In this case, two COM ports are enabled with Windows (the numbering of the COM ports can be seen via the Windows Device Manager):

- SARA-N2 UART interface is available over the first COM port (for AT commands and data)
- SARA-N2 secondary / auxiliary UART interface is available over the second COM port (for diagnostic)

Make sure to appropriately set the related slide switches:

- SW401 set to On-Board
- SW403 set to Mini-USB
- SW510 set to UART1

Then, run a terminal application (as for example the u-blox m-center tool), selecting the appropriate diagnostic COM port with the following settings:

- Data rate: 921600 b/s
- Data bits: 8
- Parity: N
- Stop bits: 1
- Flow control: None

See Appendix A for how to configure the u-blox m-center AT terminal for Windows.

Appendix

A Setting up AT terminal applications for communication with EVK-N2

The u-blox m-center cellular module evaluation tool is a powerful platform for evaluating, configuring and testing u-blox cellular products. m-center includes an AT commands terminal for communication with the device and can be downloaded free-of-charge from our website (<http://www.u-blox.com>).

1. Follow the board setup instructions in section 1.8 to provide all the required connections and switching on the cellular module.
2. Run the m-center tool: after the m-center start-up, the **Home** page appears.
3. On the **Home** page, set up the AT COM port with the setting values described in section 1.8.
Check with the Windows Device Manager to find out which COM port is being used by EVK-N2.
4. Enable the connection to u-blox cellular module by clicking on the **Connect** button.
5. Click on the **AT Terminal** button (upper right of the **Home** page). A new window opens and the AT-command terminal is now ready for communication with EVK-N2.

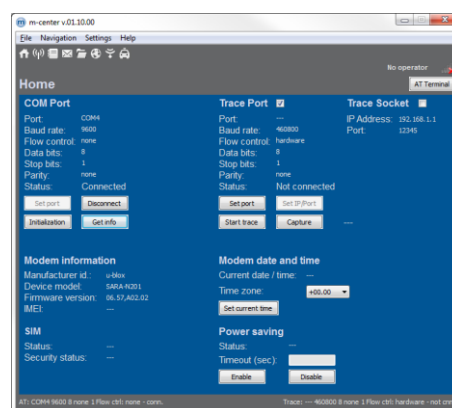



Figure 3: "Home" page

6. The AT terminal is ready to use. Click on the drop-down menu on the upper right of the AT-command terminal and select **SARA-N2** to get the list of supported AT commands.
For the complete list of AT commands supported by the modules and their syntax, see the SARA-N2 series AT Commands Manual [1].
7. In case it is required to collect a trace file, open a second m-center window and set the AT COM port according to the instructions provided in section 1.8.

 The trace interface is available over the second numbered COM port opened when a USB cable is connected to the mini USB connector (J501)

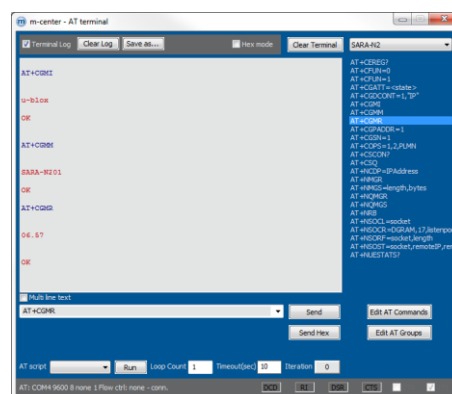

Figure 4: AT Terminal window

For more information using the u-blox m-center cellular module evaluation tool, press the F1 key on the keyboard to open the m-center help window on the computer.

B AT commands examples

For the complete description and syntax of the AT commands supported by SARA-N2 series modules, see the SARA-N2 series AT commands Manual [1].

For detailed AT commands examples for network registration and configuration, context activation, data connection management, SIM management, module interfaces configurations and other settings, see the u-blox NB-IoT system User Guide [3].

C Current consumption measurement

Current consumption of SARA-N2 series modules can be measured on the EVK-N2 evaluation kits by removing the jumper socket from the **Cellular VCC supply jumper** J103 available on the SARA-N2 Adapter Board, as shown in Figure 5.

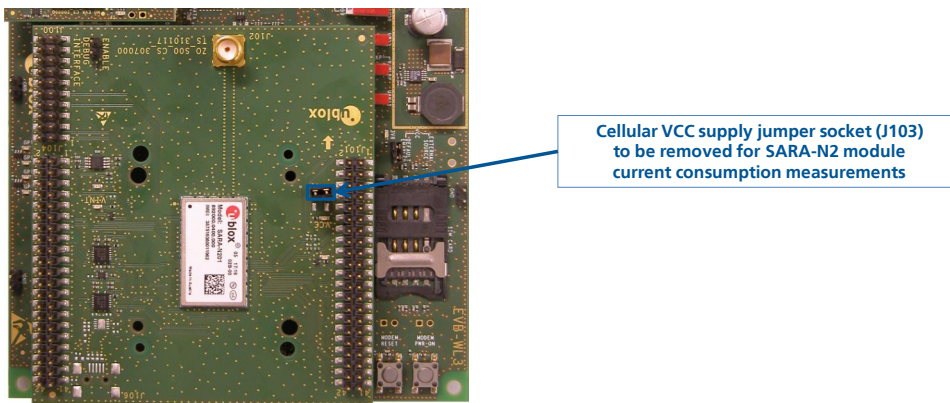

Figure 5: Jumper socket to be removed for SARA-N2 modules current consumption measurement

A suitable external digital multi-meter (as for example the Agilent 34410A or 34411A) can be used for current consumption measurements: in this case the supply circuit on the EVB will supply the SARA-N2 module mounted on the adapter board, with the digital multi-meter placed in series as described in Figure 6.

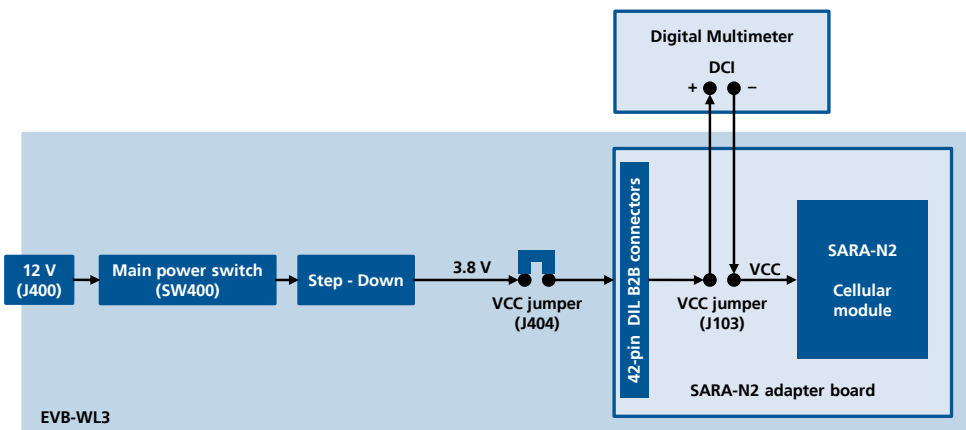

Figure 6: Block diagram of current consumption setup for SARA-N2

Alternatively, a suitable external DC power supply with dynamic current measurement capabilities (as for example the Agilent 66319B/D) can be used for current consumption measurements, acting also as supply source for the SARA-N2 module mounted on the adapter board.

Declaration of conformities

The equipment is intended for indoor usage. It is the user's duty to verify if further restrictions apply, such as in airplanes, hospitals or hazardous locations (petrol stations, refineries...).

Any changes or modification made to this equipment will void its compliance to the safety requirements.

Maintenance, inspections and/or repairs of the EVK-N2 evaluation kits shall be performed by u-blox AG.

Related documents

- [1] u-blox SARA-N2 series AT commands manual, Docu No UBX-16014887
- [2] u-blox SARA-N2 series Data Sheet, Docu No UBX-15025564
- [3] u-blox NB-IoT System User Guide, Docu No UBX-16017368
- [4] u-blox SARA-N2 series System Integration Manual, Docu No UBX-17005143

All these documents are available on request. Contact u-blox technical support for more details.



For regular updates to u-blox documentation and to receive product change notifications, register on our website.

Revision history

Revision	Date	Name	Comments
R01	22-Feb-2017	sfal	Initial release
R02	06-Jun-2017	sses	Updated description of all the EVK-N2 evaluation kits to "02" product version Added description of EVK-N211
R03	09-Oct-2017	sses	Updated product description of all the EVK-N2 evaluation kits

Contact

For complete contact information visit us at www.u-blox.com

u-blox Offices

North, Central and South America

u-blox America, Inc.

Phone: +1 703 483 3180
E-mail: info_us@u-blox.com

Regional Office West Coast:

Phone: +1 408 573 3640
E-mail: info_us@u-blox.com

Technical Support:

Phone: +1 703 483 3185
E-mail: support_us@u-blox.com

Headquarters

Europe, Middle East, Africa

u-blox AG

Phone: +41 44 722 74 44
E-mail: info@u-blox.com
Support: support@u-blox.com

Documentation Feedback

E-mail: docsupport@u-blox.com

Asia, Australia, Pacific

u-blox Singapore Pte. Ltd.

Phone: +65 6734 3811
E-mail: info_ap@u-blox.com
Support: support_ap@u-blox.com

Regional Office Australia:

Phone: +61 2 8448 2016
E-mail: info_anz@u-blox.com
Support: support_ap@u-blox.com

Regional Office China (Beijing):

Phone: +86 10 68 133 545
E-mail: info_cn@u-blox.com
Support: support_cn@u-blox.com

Regional Office China (Chongqing):

Phone: +86 23 6815 1588
E-mail: info_cn@u-blox.com
Support: support_cn@u-blox.com

Regional Office China (Shanghai):

Phone: +86 21 6090 4832
E-mail: info_cn@u-blox.com
Support: support_cn@u-blox.com

Regional Office China (Shenzhen):

Phone: +86 755 8627 1083
E-mail: info_cn@u-blox.com
Support: support_cn@u-blox.com

Regional Office India:

Phone: +91 80 4050 9200
E-mail: info_in@u-blox.com
Support: support_in@u-blox.com

Regional Office Japan (Osaka):

Phone: +81 6 6941 3660
E-mail: info_jp@u-blox.com
Support: support_jp@u-blox.com

Regional Office Japan (Tokyo):

Phone: +81 3 5775 3850
E-mail: info_jp@u-blox.com
Support: support_jp@u-blox.com

Regional Office Korea:

Phone: +82 2 542 0861
E-mail: info_kr@u-blox.com
Support: support_kr@u-blox.com

Regional Office Taiwan:

Phone: +886 2 2657 1090
E-mail: info_tw@u-blox.com
Support: support_tw@u-blox.com

X-ON Electronics

Largest Supplier of Electrical and Electronic Components

Click to view similar products for [Data Conversion IC Development Tools](#) category:

Click to view products by [U-Blox](#) manufacturer:

Other Similar products are found below :

[EV-AD5443/46/53SDZ](#) [EVAL-AD5063EBZ](#) [EVAL-AD5064EBZ](#) [EVAL-AD5361EBZ](#) [EVAL-AD5363EBZ](#) [EVAL-AD5373EBZ](#) [EVAL-AD5422LFEBZ](#) [EVAL-AD5629RSDZ](#) [EVAL-AD5755-1SDZ](#) [EVAL-AD5821AEBZ](#) [EVAL-AD7175-8SDZ](#) [EVAL-AD7262EDZ](#) [EVAL-AD7265EDZ](#) [EVAL-AD7366SDZ](#) [EVAL-AD7634EDZ](#) [EVAL-AD7641EDZ](#) [EVAL-AD7655EDZ](#) [EVAL-AD7674EDZ](#) [EVAL-AD7705EBZ](#) [EVAL-AD7718EBZ](#) [EVAL-AD7719EBZ](#) [EVAL-AD7730LEBZ](#) [EVAL-AD774142EBZ](#) [EVAL-AD7767-1EDZ](#) [EVAL-AD7873EBZ](#) [EVAL-AD7877EBZ](#) [EVAL-AD7995EBZ](#) [AD9114-DPG2-EBZ](#) [AD9122-M5372-EBZ](#) [AD9125-M5372-EBZ](#) [AD9148-EBZ](#) [AD9211-200EBZ](#) [AD9211-300EBZ](#) [AD9219-65EBZ](#) [AD9228-65EBZ](#) [AD9230-170EBZ](#) [AD9251-20EBZ](#) [AD9251-65EBZ](#) [AD9255-105EBZ](#) [AD9255-125EBZ](#) [AD9284-250EBZ](#) [AD9286-500EBZ](#) [AD9613-170EBZ](#) [AD9627-125EBZ](#) [AD9629-20EBZ](#) [AD9709-EBZ](#) [AD9716-DPG2-EBZ](#) [AD9737A-EBZ](#) [AD9739A-EBZ](#) [AD9740ACP-PCBZ](#)