

MAX-7

u-blox 7 GNSS modules

Data Sheet

Highlights:

- Miniature LCC package
- GNSS engine for GPS/QZSS, GLONASS
- Low power consumption
- Product variants to meet performance and cost requirements
- Pin-to-pin and software compatible with MAX-6 family



Document Information

Title	MAX-7	
Subtitle	u-blox 7 GNSS modules	
Document type	Data Sheet	
Document number	UBX-13004068	
Revision and date	R06	02-Jun-2021
Document status	Production Information	

Document status information

Objective Specification	Document contains target values. Revised and supplementary data will be published later.
Advance Information	Document contains data based on early testing. Revised and supplementary data will be published later.
Early Production Information	Document contains data from product verification. Revised and supplementary data may be published later.
Production Information	Document contains the final product specification.

This document applies to the following products:

Product name	Type number	ROM/FLASH version	PCN reference
MAX-7C	MAX-7C-0-000	ROM1.00	N/A
MAX-7Q	MAX-7Q-0-001	ROM1.00	UBX-21015025
MAX-7W	MAX-7W-0-000	ROM1.00	N/A

u-blox reserves all rights to this document and the information contained herein. Products, names, logos and designs described herein may in whole or in part be subject to intellectual property rights. Reproduction, use, modification or disclosure to third parties of this document or any part thereof without the express permission of u-blox is strictly prohibited.

The information contained herein is provided "as is" and u-blox assumes no liability for the use of the information. No warranty, either express or implied, is given, including but not limited to, with respect to the accuracy, correctness, reliability and fitness for a particular purpose of the information. This document may be revised by u-blox at any time. For most recent documents, visit www.u-blox.com.

Copyright © 2021, u-blox AG.

u-blox® is a registered trademark of u-blox Holding AG in the EU and other countries. ARM® is the registered trademark of ARM Limited in the EU and other countries.

Contents

Contents.....	3
1 Functional description.....	5
1.1 Overview.....	5
1.2 Product features.....	5
1.3 GNSS performance.....	6
1.3.1 GPS performance.....	6
1.3.2 GLONASS performance.....	7
1.4 Block diagram.....	8
1.5 GNSS.....	8
1.5.1 GPS.....	8
1.5.2 GLONASS.....	8
1.5.3 QZSS.....	8
1.6 Augmented GNSS.....	8
1.6.1 Assisted GNSS (A-GPS).....	9
AssistNow Online.....	9
AssistNow Offline.....	9
1.6.2 AssistNow Autonomous.....	9
1.6.3 Satellite-Based Augmentation System (SBAS).....	9
1.7 EXTINT: External interrupt.....	9
1.7.1 Pin Control.....	9
1.7.2 Aiding.....	9
1.8 TIMEPULSE.....	10
1.9 Protocols and interfaces.....	10
1.10 Interfaces.....	10
1.10.1 UART.....	10
1.10.2 Display Data Channel (DDC).....	10
1.11 Clock generation.....	10
1.11.1 Oscillators.....	10
1.11.2 Real-Time Clock (RTC).....	11
1.12 Power management.....	11
1.12.1 DC/DC converter.....	11
1.12.2 Operating modes.....	11
1.13 Antenna.....	12
1.13.1 Active antenna control (ANT_ON).....	12
1.13.2 Antenna supervisor and short circuit detection.....	12
2 Pin Definition.....	13
2.1 Pin assignment.....	13
3 Configuration management.....	14

4	Electrical specification.....	14
4.1	Absolute maximum rating	14
4.2	Operating conditions	15
4.3	Indicative current requirements.....	16
5	Mechanical specifications	17
6	Reliability tests and approvals	18
6.1	Reliability tests.....	18
6.2	Approvals	18
7	Product handling & soldering.....	18
7.1	Packaging	18
7.1.1	Reels.....	18
7.1.2	Tapes.....	18
7.2	Shipment, storage and handling.....	19
7.2.1	Moisture Sensitivity Levels	19
7.2.2	Reflow soldering	19
7.2.3	ESD handling precautions	20
8	Default messages	21
9	Labeling and ordering information.....	22
9.1	Product labeling.....	22
9.2	Explanation of codes.....	22
9.3	Ordering codes.....	22
	Related documents	23
	Revision history.....	23
	Contact.....	24

1 Functional description

1.1 Overview

The MAX-7 series is the newest family of standalone GNSS modules from u-blox. With the exceptional performance of the u-blox 7 GNSS (GPS, GLONASS, QZSS and SBAS) engine, the MAX-7 series delivers high sensitivity and minimal acquisition times in the industry proven MAX form factor.

The MAX-7 series provides maximum sensitivity while maintaining low system power. The MAX-7C is optimized for cost sensitive applications, the MAX-7Q provides best performance and lowest power consumption, while the MAX-7W provides best performance and is optimized for active antennas. The industry-proven MAX form factor allows easy migration from the previous MAX-6 generation. Sophisticated RF-architecture and interference suppression ensure maximum performance even in GNSS-hostile environments.

The MAX-7 series combines a high level of integration capability with flexible connectivity options in a miniature package. This makes it perfectly suited for industrial applications with strict size and cost requirements. The MAX-7Q is also halogen free (green) which makes it also perfectly suited for consumer applications. The I²C compatible DDC interface provides connectivity and enables synergies with u-blox cellular modules.

u-blox 7 modules use GNSS chips qualified according to AEC-Q100 and are manufactured in ISO/TS 16949 certified sites. Qualification tests are performed as stipulated in the ISO16750 standard: “Road vehicles – Environmental conditions and testing for electrical and electronic equipment”.

1.2 Product features

Model	Type	Supply	Interfaces	Features	Grade
	GPS / QZSS GLONASS Galileo BeiDou Timing Dead Reckoning Precise Point Positioning Raw Data	1.65 V – 3.6 V 2.7 V – 3.6 V Lowest power (DC/DC)	UART USB SPI DDC (I ² C compliant)	Programmable (Flash) Data logging Additional SAW Additional LNA RTC crystal Internal oscillator Active antenna / LNA supply Active antenna / LNA control Antenna short circuit detection / protection pin Antenna open circuit detection pin Frequency output	Standard Professional Automotive
MAX-7C	• •	• •	• •	◆ C ○ • •	
MAX-7Q	• •	• •	• •	• T ○ • •	
MAX-7W	• •	•	•	• T • • •	

○ = Optional, not activated per default or requires external components

◆ = Higher backup current

C = Crystal / T = TCXO

1.3 GNSS performance

1.3.1 GPS performance

Parameter	Specification		
Receiver type	56 Channels u-blox 7 engine GPS/QZSS L1C/A SBAS: WAAS, EGNOS, MSAS		
Time-To-First-Fix ¹		MAX-7Q/W	MAX-7C
	Cold Start	29 s	30 s
	Warm Start	28 s	28 s
	Hot Start	1 s	1 s
	Aided Starts ²	5 s	5 s
Sensitivity ³		MAX-7Q/W	MAX-7C
	Tracking & Navigation	-161 dBm	-160 dBm
	Reacquisition	-160 dBm	-160 dBm
	Cold Start	-148 dBm	-147 dBm
	Warm Start	-148 dBm	-148 dBm
	Hot Start	-156 dBm	-155 dBm
Horizontal position accuracy ⁴	Autonomous	2.5 m	
	SBAS	2.0 m	
Accuracy of time pulse signal	RMS	30 ns	
	99%	60 ns	
Frequency of time pulse signal		0.25 Hz ... 10 MHz (configurable)	
Max navigation update rate		10 Hz	
Velocity accuracy ⁵		0.1 m/s	
Heading accuracy ⁵		0.5 degrees	
Operational limits ⁶	Dynamics	≤ 4 g	
	Altitude	50,000 m	
	Velocity	500 m/s	

Table 1: GPS performance

¹ All satellites at -130 dBm

² Dependent on aiding data connection speed and latency

³ Demonstrated with a good external LNA

⁴ CEP, 50%, 24 hours static, -130 dBm, > 6 SVs

⁵ 50% @ 30 m/s

⁶ Assuming Airborne < 4 g platform

1.3.2 GLONASS performance

Parameter	Specification		
Receiver type	56 Channels u-blox 7 engine GLONASS L1 FDMA		
Time-To-First-Fix ⁷		MAX-7Q/W	MAX-7C
	Cold Start	30 s	32 s
	Warm Start	25 s	25 s
	Hot Start	1 s	1 s
Sensitivity ⁸		MAX-7Q/W	MAX-7C
	Tracking & Navigation	-158 dBm	-158 dBm
	Reacquisition	-156 dBm	-156 dBm
	Cold Start	-140 dBm	-139 dBm
	Warm Start	-145 dBm	-145 dBm
	Hot Start	-156 dBm	-155 dBm
Horizontal position accuracy ⁹		4.0 m	
Accuracy of time pulse signal	RMS	50 ns	
	99%	100 ns	
Frequency of time pulse signal		0.25 Hz ... 10 MHz (configurable)	
Max navigation update rate		10 Hz	
Velocity accuracy ¹⁰		0.1 m/s	
Heading accuracy ¹⁰		0.5 degrees	
Operational limits ¹¹	Dynamics	≤ 4 g	
	Altitude	50,000 m	
	Velocity	500 m/s	

Table 2: GLONASS performance

⁷ All satellites at -130 dBm

⁸ Demonstrated with a good external LNA

⁹ CEP, 50%, 24 hours static, -130 dBm, > 6 SVs

¹⁰ 50% at 30 m/s

¹¹ Assuming Airborne < 4 g platform

1.4 Block diagram

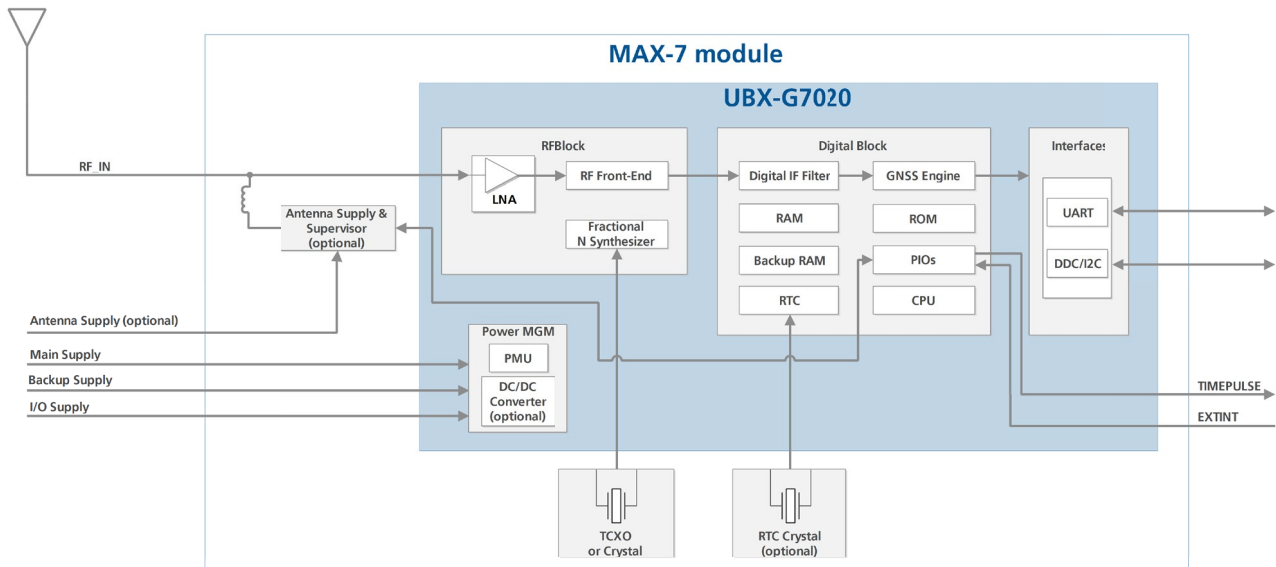

Figure 1: MAX-7 block diagram

1.5 GNSS

u-blox MAX-7 positioning modules are GNSS receivers and can singly receive and track GPS (including SBAS and QZSS) and GLONASS signals. QZSS and SBAS signals (by default) can be received concurrently with GPS signals.

1.5.1 GPS

u-blox MAX-7 positioning modules are designed to receive and track the L1C/A signals provided at 1575.42 MHz by the Global Positioning System (GPS).

1.5.2 GLONASS

The Russian GLONASS satellite system is an alternative system to the US-based Global Positioning System (GPS). The MAX-7 series modules are capable of receiving and processing GLONASS signals using the same hardware and provide the lowest power GLONASS functionality in the industry at low cost and with minimal integration effort. In order to take advantage of GPS and GLONASS, dedicated hardware preparation must be taken during the design-in phase, see the *MAX-7 / NEO-7 Hardware Integration Manual* [1] for u-blox design recommendations.

The ability to receive and track GLONASS L1OF satellite signals with the same hardware results in an optimized hardware BOM and allows design of GLONASS ready receivers where required by regulations.



GLONASS and GPS signals cannot be received and tracked simultaneously by u-blox MAX-7 modules.

1.5.3 QZSS

The Quasi-Zenith Satellite System (QZSS) is a navigation satellite overlay system for the Pacific region covering Japan and Australia which transmits additional GPS L1C/A signals. u-blox MAX-7 positioning modules are able to receive and track these signals simultaneously with GPS, resulting in better availability, especially under bad signal conditions e.g. in urban canyons.

1.6 Augmented GNSS



For more details about augmented GNSS, see the *u-blox 7 Receiver Description Including Protocol Specification* [2].

1.6.1 Assisted GNSS (A-GPS)

A-GPS improves GNSS performance by delivering aiding data to the GNSS receiver via wireless networks or the Internet. Supplying information such as ephemeris, almanac, approximate last position, time and satellite status and an optional time synchronization signal significantly reduces Time to First Fix (TTFF) and improves acquisition sensitivity.

AssistNow Online and AssistNow Offline are u-blox end-to-end A-GPS services for devices with or without network connectivity. AssistNow Online and AssistNow Offline can either be used alone or in combination. They are very easy to implement, require no additional hardware, and generate virtually no CPU load. All MAX-7 series modules support u-blox' AssistNow Online, AssistNow Offline and AssistNow Autonomous A-GPS services, and are OMA SUPL compliant.

AssistNow Online

With AssistNow Online, an internet-connected GNSS device downloads assistance data from u-blox' AssistNow Online Service at system start-up. AssistNow Online is network operator independent and globally available. u-blox only sends ephemeris data for those satellites currently visible to the device requesting the data, thus minimizing the amount of data transferred.

AssistNow Offline

With AssistNow Offline, users download u-blox Differential Almanac Correction Data from the Internet at their convenience. The correction data can be stored in the memory of the application processor. Therefore, the service requires no connectivity at system start-up and enables a position fix within seconds, even when no network is available.

1.6.2 AssistNow Autonomous

AssistNow Autonomous provides functionality similar to Assisted GNSS without the need for a host or external network connection. It is an embedded feature available free-of-charge that accelerates GNSS positioning by capitalizing on the periodic nature of GPS satellite orbits. GPS orbit predictions are directly calculated by the GNSS receiver and no external aiding data or connectivity is required. AssistNow Autonomous can be used alone, or together with AssistNow Online or AssistNow Offline for increased positioning speed and accuracy.



For more details see the *u-blox 7 Receiver Description Including Protocol Specification* [2].

1.6.3 Satellite-Based Augmentation System (SBAS)

u-blox MAX-7 positioning modules support SBAS. These systems supplement GPS data with additional regional or wide area GPS augmentation data. The system broadcasts augmentation data via satellite which can be used by GPS receivers to improve the resulting GPS precision. SBAS satellites can be used as additional satellites for ranging (navigation), further enhancing precision. The following SBAS are supported with MAX-7 modules: WAAS, EGNOS and MSAS.



For more details see the *u-blox 7 Receiver Description Including Protocol Specification* [2].

1.7 EXTINT: External interrupt

EXTINT is an external interrupt pin with fixed input voltage thresholds with respect to VCC_IO. It can be used for Control of the receiver or for Aiding.

For more information about how to implement and configure these features see the *u-blox 7 Receiver Description including Protocol Specification* [2] and the *MAX-7 / NEO-7 Hardware Integration Manual* [1].

1.7.1 Pin Control

The pin control feature allows overriding the automatic active/inactive cycle of Power Save Mode. The state of the receiver can be controlled through the EXTINT pin.

The receiver can also be turned off and sent into Backup Mode using EXTINT when Power Save Mode is not active.

1.7.2 Aiding

The EXTINT pin can be used to supply time or frequency aiding data to the receiver. For time aiding the time can be supplied using hardware time synchronization where an accurate time pulse is connected to the EXTINT pin.

Frequency aiding can be implemented by connecting a periodic rectangular signal with a frequency up to 500 kHz and arbitrary duty cycle (low/high phase duration must not be shorter than 50 ns) to the EXTINT pin, and providing the applied frequency value to the receiver using UBX messages.

1.8 TIMEPULSE

A configurable time pulse signal is available with MAX-7 series modules.

The TIMEPULSE output generates pulse trains synchronized with GPS or UTC time grid with intervals configurable over a wide frequency range. Thus it may be used as a low frequency time synchronization pulse or as a high frequency reference signal.

By default the time pulse signal is configured to 1 pulse per second. For more information see the *u-blox 7 Receiver Description including Protocol Specification* [2].

1.9 Protocols and interfaces

Protocol	Type
NMEA	Input/output, ASCII, 0183, 2.3 (compatible to 3.0)
UBX	Input/output, binary, u-blox proprietary
RTCM	Input, message 1, 2, 3, 9

Table 3: Available Protocols

All protocols are available on UART and DDC (I²C compliant). For specification of the various protocols see the *u-blox 7 Receiver Description Including Protocol Specification* [2].

1.10 Interfaces

A number of interfaces are provided either for data communication or memory access. The embedded firmware uses these interfaces according to their respective protocol specifications.

1.10.1 UART

MAX-7 modules include one UART interface, which can be used for communication to a host. It supports configurable baud rates. For supported baud rates see the *u-blox 7 Receiver Description Including Protocol Specification* [2].

1.10.2 Display Data Channel (DDC)

An I²C compliant DDC interface is available for communication with an external host CPU. The interface can be operated in slave mode only. The DDC protocol and electrical interface are fully compatible with the Fast-Mode of the I²C industry standard. Since the maximum SCL clock frequency is 400 kHz, the maximum transfer rate is 400 kb/s.

The DDC interface is I²C Fast Mode compliant. For timing parameters consult the I²C standard.



The maximum bit rate is 400 kb/s. The interface stretches the clock when slowed down while serving interrupts, so real bit rates may be slightly lower.

1.11 Clock generation

1.11.1 Oscillators

MAX-7 GNSS modules are available in Crystal and TCXO versions. The TCXO option allows accelerated weak signal acquisition, enabling faster start and reacquisition times.

The careful selection and qualification of critical parts, such as GNSS oscillators, has resulted in u-blox modules being the most reliable positioning modules in the industry, particularly in challenging conditions.

1.11.2 Real-Time Clock (RTC)

The RTC is driven by a 32 kHz oscillator, which makes use of a RTC crystal. If the main supply voltage fails and a battery is connected to V_BCKP, parts of the receiver switch off, but the RTC still runs providing a timing reference for the receiver. This operating mode is called Hardware Backup Mode, which enables all relevant data to be saved in the backup RAM to allow a hot or warm start later.

With MAX-7C in Hardware Backup Mode the main oscillator is used as timing reference instead of the 32 kHz oscillator. MAX-7C apply single crystal mode, where the 26 MHz crystal oscillator can also be used to provide a frequency reference to the RTC without using an additional crystal for the RTC. This makes MAX-7C a more cost efficient solution at the expense of a higher backup current.



For more information see the *MAX-7 / NEO-7 Hardware Integration Manual* [1].

1.12 Power management

u-blox 7 technology offers a power optimized architecture with built-in autonomous power saving functions to minimize power consumption at any given time. Furthermore, the receiver can be used in two operating modes: Continuous mode for best performance or Power Save Mode for optimized power consumption, respectively. In addition a high efficiency DC/DC converter is integrated to allow low power consumption even for higher main supply voltages.

1.12.1 DC/DC converter

MAX-7Q and MAX-7C Modules integrate a DC/DC converter, providing a reduced power consumption by up to 50% especially when using a main supply voltage above 2.5 V.



For more information see the *MAX-7 / NEO-7 Hardware Integration Manual* [1].

1.12.2 Operating modes

MAX-7 series modules have two operating modes:

- Continuous Mode for best GNSS performance
- Power Save Mode to optimize power consumption

1.12.2.1 Continuous Mode

Continuous Mode uses the acquisition engine at full performance resulting in the shortest possible TTFF and the highest sensitivity. It searches for all possible satellites until the almanac is completely downloaded. The receiver then switches to the tracking engine to lower power consumption.

Thus, a lower tracking current consumption level will be achieved when:

- A valid GNSS position is obtained
- The entire almanac has been downloaded
- The ephemeris for each satellite in view is valid

1.12.2.2 Power Save Mode

For power sensitive applications u-blox MAX-7 receivers provide a Power Save Mode for reduced power consumption.

Power Save Mode provides two dedicated methods called ON/OFF and Cyclic tracking, that reduce average current consumption in different ways to match the needs of the specific application. These options can be set by using a specific UBX message.



For more information about power management strategies, see the *u-blox 7 Receiver Description Including Protocol Specification* [2].



Power Save Mode is not available in GLONASS mode.

1.13 Antenna

MAX-7 modules are designed for use with passive¹² and active¹³ antennas.

Parameter	Specification	
Antenna Type	Passive and active antenna	
Active Antenna Recommendations	Minimum gain	15 dB (to compensate signal loss in RF cable)
	Maximum gain	50 dB
	Maximum noise figure	1.5 dB

Table 4: Antenna Specifications for all MAX-7 modules

1.13.1 Active antenna control (ANT_ON)

The ANT_ON Pin can be used to turn on and off an external LNA or an active antenna. This reduces power consumption in Power Save Mode or Backup mode. This pin is available only on MAX-7C and MAX-7Q.

1.13.2 Antenna supervisor and short circuit detection

An antenna supervisor is available with MAX-7W. The antenna supervisor enables the receiver to detect short circuits at the active antenna and shut down the voltage bias immediately. A series resistor is needed in front of the **V_ANT** input to enable checking of the antenna bias voltage. UBX and NMEA messages are provided to report the condition of the antenna supply. Open circuit detection can also be supported with an additional external circuit.



Antenna open circuit detection can be mapped to PIO13 and require external components.



For more information see the *MAX-7 / NEO-7 Hardware Integration Manual* [1].

¹² For integration MAX-7 modules with cellular products, see the *MAX-7 / NEO-7 Hardware Integration Manual* [1].

¹³ For information on using active antennas with MAX-7 modules, see the *MAX-7 / NEO-7 Hardware Integration Manual* [1].

2 Pin Definition

2.1 Pin assignment

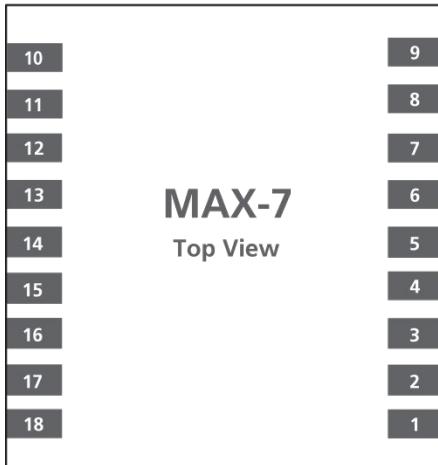

Figure 2: Pin Assignment

No	Module	Name	PIO ¹⁴ Nr.	I/O	Description
1	All	GND	-		Ground
2	All	TxD	6	O	Serial Port
3	All	RxD	7	I	Serial Port
4	All	TIMEPULSE	11	O	Time pulse (1PPS)
5	All	EXTINT	13	I	External Interrupt Pin
6	All	V_BCKP	-		Backup voltage supply
7	All	VCC_IO	-		IO Supply Voltage
8	All	VCC	-		Supply voltage
9	All	RESET_N	-	I	RESET_N
10	All	GND	-		Ground
11	All	RF_IN	-	I	GNSS signal input
12	All	GND	-		Ground
13	MAX-7C/Q	ANT_ON	16	O	Antenna control
	MAX-7W	Reserved	-	-	Reserved
14	All	VCC_RF	-		Output Voltage RF section
15	MAX-7W	V_ANT	-		Active Antenna Supply Voltage
	MAX-7C/Q	Reserved	-	-	Reserved
16	All	SDA	9	I/O	DDC Data
17	All	SCL	8	I/O	DDC Clock
18	All	Reserved	-	-	Reserved

Table 5: Pinout



Pins designated Reserved should not be used. For more information about Pinouts see the *MAX-7 / NEO-7 Hardware Integration Manual* [1].

¹⁴ Peripheral Input Output

3 Configuration management

Configuration settings can be modified with UBX configuration messages. The modified settings remain effective until power-down or reset. If these settings have been stored in battery-backup RAM, then the modified configuration will be retained, as long as the backup battery supply is not interrupted.



For more information about configuration management, see the *u-blox 7 Receiver Description Including Protocol Specification* [2].

4 Electrical specification



The limiting values given are in accordance with the Absolute Maximum Rating System (IEC 134). Stress above one or more of the limiting values may cause permanent damage to the device. These are stress ratings only, and operation of the device at these or at any other conditions above those given in the Characteristics sections of the specification is not implied. Exposure to these limits for extended periods may affect device reliability.



Where application information is given, it is advisory only and does not form part of the specification. For more information see the *MAX-7 / NEO-7 Hardware Integration Manual* [1].

4.1 Absolute maximum rating

Parameter	Symbol	Module	Condition	Min	Max	Units
Power supply voltage	VCC, VCC_IO	All		-0.5	3.6	V
Backup battery voltage	V_BCKP	All		-0.5	3.6	V
Input pin voltage	V _{in}	All		-0.5	3.6	V
DC current through any digital I/O pin (except supplies)	I _{pin}				10	mA
VCC_RF output current	ICC_RF	All			100	mA
Input power at RF_IN	P _{rfin}	All	source impedance = 50 Ω, continuous wave		13	dBm
Antenna bias voltage	V_ANT				6	V
Antenna bias current	I_ANT				100	mA
Storage temperature	T _{stg}	All		-40	85	°C

Table 6: Absolute maximum ratings



Stressing the device beyond the “Absolute Maximum Ratings” may cause permanent damage. These are stress ratings only. The product is not protected against overvoltage or reversed voltages. If necessary, voltage spikes exceeding the power supply voltage specification, given in table above, must be limited to values within the specified boundaries by using appropriate protection diodes.

4.2 Operating conditions



All specifications are at an ambient temperature of 25°C. Extreme operating temperatures can significantly impact specification values. Applications operating near the temperature limits should be tested to ensure the specification.

Parameter	Symbol	Module	Min	Typ	Max	Units	Condition
Power supply voltage	VCC, VCC_IO	MAX-7C	1.65	3.0	3.6	V	
		MAX-7Q/W	2.7	3.0	3.6	V	
Backup battery voltage	V_BCKP	All	1.4		3.6	V	
Backup battery current	I_BCKP	MAX-7Q/W		15		μA	V_BCKP = 3.0 V, VCC = 0 V
		MAX-7C		300		μA	V_BCKP = 3.0 V, VCC = 0 V (ESR dependent)
SW backup current	I_SWBCKP	MAX-7Q		20		μA	VCC_IO = VCC = 3.0 V (ESR dependent)
		MAX-7W		50		μA	VCC_IO = VCC = 3.0 V (ESR dependent)
		MAX-7C		305		μA	VCC_IO = VCC = 3.0 V (ESR dependent)
Input pin voltage range	V _{in}	All	0		VCC_IO	V	
Digital IO Pin Low level input voltage	V _{il}	All	0		0.2*VCC_IO	V	
Digital IO Pin High level input voltage	V _{ih}	All	0.7*VCC_IO		VCC_IO+0.5	V	
Digital IO Pin Low level output voltage	V _{ol}	All			0.4	V	I _{ol} = 4 mA
Digital IO Pin High level output voltage	V _{oh}	All	VCC_IO - 0.4			V	I _{oh} = 4 mA
V_ANT antenna bias voltage	V_ANT	2.7			5.5	V	I _{ANT} < -50 mA
Antenna bias voltage drop	V_ANT_DROP		0.1			V	ICC_RF = 50 mA
VCC_RF voltage	VCC_RF	All		VCC-0.1		V	
VCC_RF output current	ICC_RF	All			50	mA	
Receiver Chain Noise Figure	NF _{tot}	All		3.5		dB	
Operating temperature	T _{opr}	All	-40		85	°C	

Table 7: Operating conditions



Operation beyond the specified operating conditions can affect device reliability.

4.3 Indicative current requirements

Table 8 lists examples of the total system supply current for a possible application.



Values in Table 8 are provided for customer information only as an example of typical power requirements. Values are characterized on samples, actual power requirements can vary depending on FW version used, external circuitry, number of SVs tracked, signal strength, type of start as well as time, duration and conditions of test.

Parameter	Symbol	Module	Min	Typ	Max	Units	Condition
Max. supply current ¹⁵	Iccp	All			67	mA	
			MAX-7C	21.0		mA	
		Icc Acquisition ¹⁸	MAX-7W	39.5		mA	Estimated at 3V
	MAX-7Q	22.0		mA			
Average supply current ^{16, 17}	Icc Tracking (Continuous mode,)	MAX-7C		16.5		mA	Estimated at 3V
		MAX-7W		29.5		mA	
		MAX-7Q		17.5		mA	
	Icc Tracking (Power Save mode / 1 Hz)	MAX-7C		4.5		mA	Estimated at 3V
		MAX-7W		7.0		mA	
		MAX-7Q		5.0		mA	

Table 8: Indicative power requirements at 3.0 V



For more information about power requirements, see the *MAX-7 / NEO-7 Hardware Integration Manual* [1].

¹⁵ Use this figure to dimension maximum current capability of power supply. Measurement of this parameter with 1 Hz bandwidth.

¹⁶ Use this figure to determine required battery capacity.

¹⁷ Simulated constellation of 8 satellites is used. All signals are at -130 dBm. VCC= 3 V

¹⁸ Average current from start-up until the first fix.

5 Mechanical specifications

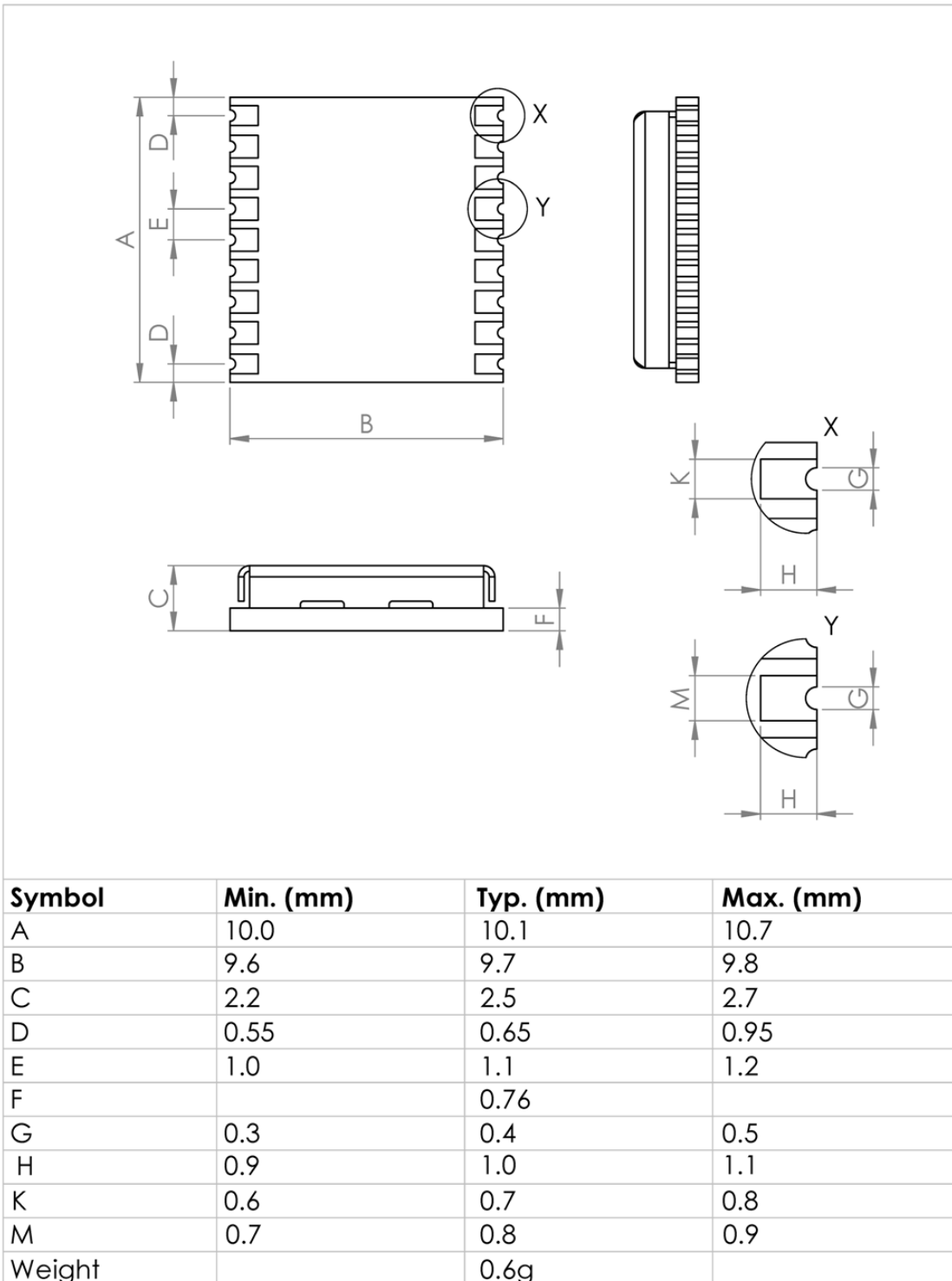

Figure 3: Dimensions



For information regarding the Paste Mask and Footprint see the MAX-7 / NEO-7 Hardware Integration Manual [1].

6 Reliability tests and approvals

6.1 Reliability tests



All MAX-7 modules are based on AEC-Q100 qualified GNSS chips.

Tests for product family qualifications are according to ISO 16750 "Road vehicles - Environmental conditions and testing for electrical and electronic equipment", and appropriate standards.

6.2 Approvals



Products marked with this lead-free symbol on the product label comply with the "Directive 2002/95/EC of the European Parliament and the Council on the Restriction of Use of certain Hazardous Substances in Electrical and Electronic Equipment" (RoHS).

All u-blox 7 GNSS modules are RoHS compliant.

7 Product handling & soldering

7.1 Packaging

MAX-7 modules are delivered as hermetically sealed, reeled tapes in order to enable efficient production, production lot set-up and tear-down. For more information see the *u-blox Package Information Guide* [3].

7.1.1 Reels

MAX-7 GNSS modules are deliverable in quantities of 500 pcs on a reel. MAX-7 modules are shipped on Reel Type B, as specified in the *u-blox Package Information Guide* [3].

7.1.2 Tapes

Figure 4 shows the position and orientation of MAX-7 modules as they are delivered on tape. The dimensions of the tapes are specified in Figure 5.

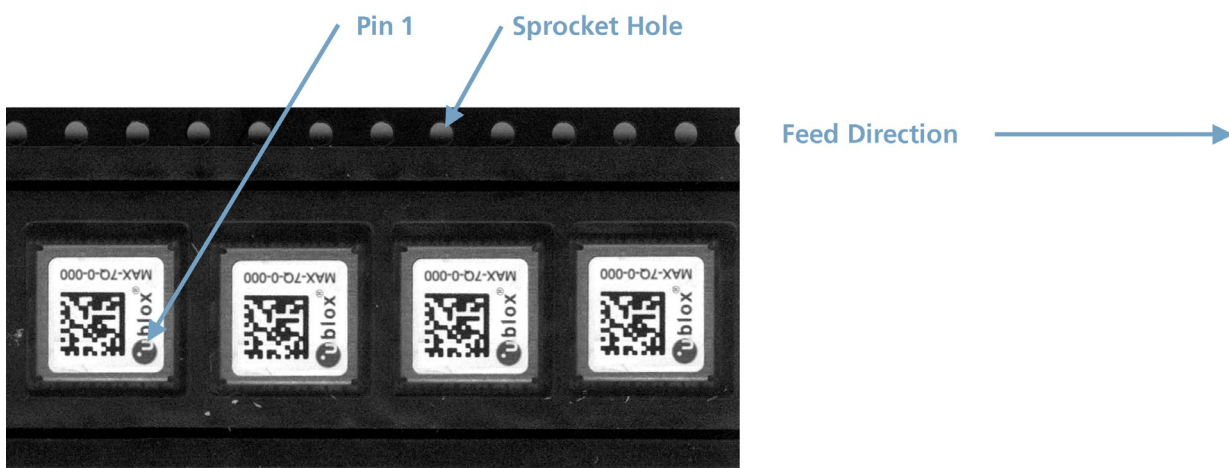

Figure 4: Tape and module orientation

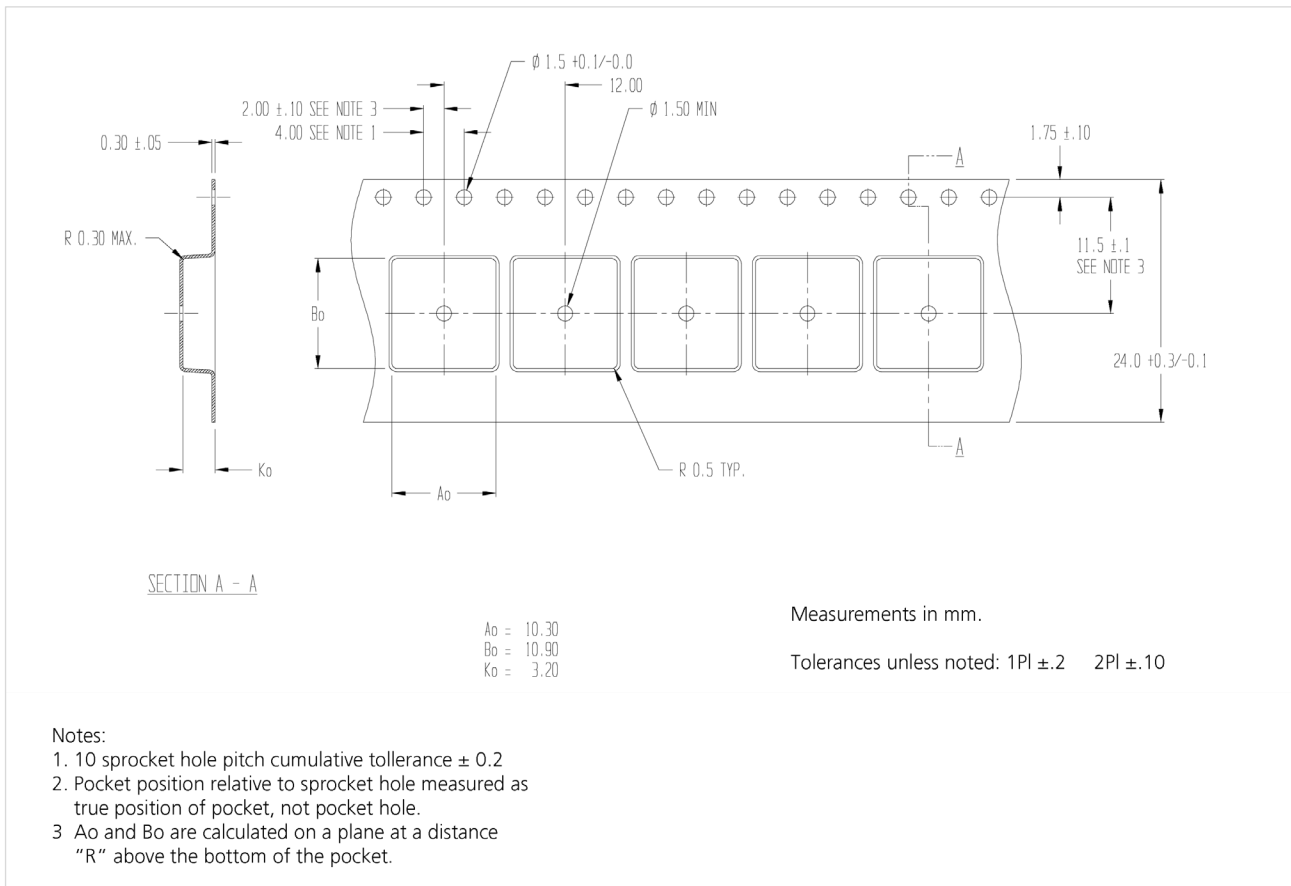

Figure 5: MAX-7 Tape dimensions

7.2 Shipment, storage and handling

For important information regarding shipment, storage and handling see the *u-blox Package Information Guide* [3].

7.2.1 Moisture Sensitivity Levels

The Moisture Sensitivity Level (MSL) relates to the packaging and handling precautions required. MAX-7 modules are rated at MSL level 4.



For MSL standard see IPC/JEDEC J-STD-020, which can be downloaded from www.jedec.org.



For more information regarding MSL see the *u-blox Package Information Guide* [3].

7.2.2 Reflow soldering

Reflow profiles are to be selected according u-blox recommendations (see the *MAX-7 / NEO-7 Hardware Integration Manual* [1]).

7.2.3 ESD handling precautions



MAX-7 modules are Electrostatic Sensitive Devices (ESD). Observe precautions for handling! Failure to observe these precautions can result in severe damage to the GNSS receiver!

GNSS receivers are Electrostatic Sensitive Devices (ESD) and require special precautions when handling. Particular care must be exercised when handling patch antennas, due to the risk of electrostatic charges. In addition to standard ESD safety practices, the following measures should be taken into account whenever handling the receiver:

- Unless there is a galvanic coupling between the local GND (i.e. the work table) and the PCB GND, then the first point of contact when handling the PCB must always be between the local GND and PCB GND.
- Before mounting an antenna patch, connect ground of the device
- When handling the RF pin, do not come into contact with any charged capacitors and be careful when contacting materials that can develop charges (e.g. patch antenna ~ 10 pF, coax cable ~ 50 - 80 pF/m, soldering iron, ...)
- To prevent electrostatic discharge through the RF input, do not touch any exposed antenna area. If there is any risk that such exposed antenna area is touched in non ESD protected work area, implement proper ESD protection measures in the design.
- When soldering RF connectors and patch antennas to the receiver's RF pin, make sure to use an ESD safe soldering iron (tip).

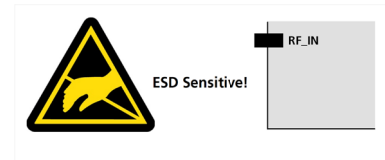

8 Default messages

Interface	Settings
UART Output	9600 Baud, 8 bits, no parity bit, 1 stop bit Configured to transmit both NMEA and UBX protocols, but only the following NMEA (and no UBX) messages have been activated at start-up: GGA, GLL, GSA, GSV, RMC, VTG, TXT
UART Input	9600 Baud, 8 bits, no parity bit, 1 stop bit, Autobauding disabled Automatically accepts following protocols without need of explicit configuration: UBX, NMEA The GNSS receiver supports interleaved UBX and NMEA messages.
DDC	Fully compatible with the I ² C industry standard, available for communication with an external host CPU or u-blox cellular modules; operated in slave mode only. NMEA and UBX are enabled as input messages, only NMEA as output messages Maximum bit rate 400 kb/s.
TIMEPULSE (1Hz Nav)	1 pulse per second, synchronized at rising edge, pulse length 100 ms

Table 9: Default messages



Please refer to the *u-blox 7 Receiver Description Including Protocol Specification* [2] for information about further settings.

9 Labeling and ordering information

9.1 Product labeling

The labeling of u-blox 7 GNSS modules includes important product information. The location of the MAX-7 series product type number is shown in Figure 6.

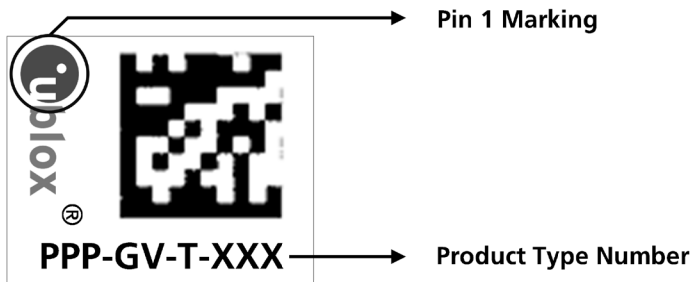

Figure 6: Location of product type number on MAX-7 module label

9.2 Explanation of codes

Three different product code formats are used. The **Product Name** is used in documentation such as this data sheet and identifies all u-blox 7 products, independent of packaging and quality grade. The **Ordering Code** includes options and quality, while the **Type Number** includes the hardware and firmware versions. Table 10 below details these three different formats:

Format	Structure
Product Name	PPP-GV
Ordering Code	PPP-GV-T
Type Number	PPP-GV-T-XXX

Table 10: Product Code Formats

The parts of the product code are explained in Table 11.

Code	Meaning	Example
PPP	Product Family	MAX
G	Product Generation	7 = u-blox 7
V	Variant	T = Timing, R = DR, etc.
T	Option / Quality Grade	Describes standardized functional element or quality grade such as Flash size, automotive grade etc.
XXX	Product Detail	Describes product details or options such as hard- and software revision, cable length, etc.

Table 11: part identification code

9.3 Ordering codes

Ordering No.	Product
MAX-7C-0	u-blox 7 GNSS Module, 1.65–3.6V, Crystal, ROM, 9.7x10.1 mm, 500 pcs/reel
MAX-7Q-0	u-blox 7 GNSS Module, 2.7–3.6V, TCXO, ROM, 9.7x10.1 mm, 500 pcs/reel
MAX-7W-0	u-blox 7 GNSS Module, 2.7–3.6V, TCXO, ROM, Active Antenna Supply, 9.7x10.1 mm, 500 pcs/reel

Table 12: Product ordering codes for professional grade modules



Product changes affecting form, fit or function are documented by u-blox. For a list of Product Change Notifications (PCNs) see our website.

Related documents

- [1] MAX-7 / NEO-7 Hardware Integration Manual, UBX-13003704
- [2] u-blox 7 Receiver Description including Protocol Specification, GPS.G7-SW-12001
- [3] u-blox Package Information Guide, UBX-14001652

Revision history

Revision	Date	Name	Status / Comments
-	14-Oct-2012	dhur	Initial release Last revision with document number GPS.G7-HW-12012
R02	04-Oct-2013	cbib	Advance Information status. Updated current values, removed USB, added VCC_IO
R03	02-Apr-2014	julu	Early Production Information. Terminology alignment for MAX-7 series GNSS module. Updated selector table in section 1.2; updated Figure 1 (removed not supported USB, SPI, SQI Flash from the Block Diagram); updated section 1.12.2 (RTC); added recommendation for using passive antenna (footnote in Table 4), added software backup current values in Table 7.
R04	24-Jul-2014	julu	Production Information.
R05	11-Nov-2014	julu	Updated section 1.2 (added product grade information to selector table)
R06	02-Jun-2021	imar	Updated type number and PCN reference for MAX-7Q in page 2.

Contact

For complete contact information, visit us at www.u-blox.com.

u-blox Offices

North, Central and South America

u-blox America, Inc.

Phone: +1 703 483 3180
Email: info_us@u-blox.com

Regional Office West Coast:

Phone: +1 408 573 3640
Email: info_us@u-blox.com

Technical Support:

Phone: +1 703 483 3185
Email: support@u-blox.com

Headquarters

Europe, Middle East, Africa

u-blox AG

Phone: +41 44 722 74 44
Email: info@u-blox.com
Support: support@u-blox.com

Asia, Australia, Pacific

u-blox Singapore Pte. Ltd.

Phone: +65 6734 3811
Email: info_ap@u-blox.com
Support: support_ap@u-blox.com

Regional Office Australia:

Phone: +61 3 9566 7255
Email: info_au@u-blox.com
Support: support_ap@u-blox.com

Regional Office China (Beijing):

Phone: +86 10 68 133 545
Email: info_cn@u-blox.com
Support: support_cn@u-blox.com

Regional Office China (Chongqing):

Phone: +86 23 6815 1588
Email: info_cn@u-blox.com
Support: support_cn@u-blox.com

Regional Office China (Shanghai):

Phone: +86 21 6090 4832
Email: info_cn@u-blox.com
Support: support_cn@u-blox.com

Regional Office China (Shenzhen):

Phone: +86 755 8627 1083
Email: info_cn@u-blox.com
Support: support_cn@u-blox.com

Regional Office India:

Phone: +91 80 405 092 00
Email: info_in@u-blox.com Support: support_in@u-blox.com

Regional Office Japan (Osaka):

Phone: +81 6 6941 3660
Email: info_jp@u-blox.com
Support: support_jp@u-blox.com

Regional Office Japan (Tokyo):

Phone: +81 3 5775 3850
Email: info_jp@u-blox.com
Support: support_jp@u-blox.com

Regional Office Korea:

Phone: +82 2 542 0861
Email: info_kr@u-blox.com
Support: support_kr@u-blox.com

Regional Office Taiwan:

Phone: +886 2 2657 1090
Email: info_tw@u-blox.com
Support: support_tw@u-blox.com

X-ON Electronics

Largest Supplier of Electrical and Electronic Components

Click to view similar products for [GPS Modules](#) category:

Click to view products by [U-Blox](#) manufacturer:

Other Similar products are found below :

[EWM-G109H01E](#) [ISM3333-C6.1](#) [GPS-11858](#) [SL871GPS232R001](#) [DD-14239](#) [GPS-10922](#) [M20050-1](#) [M20048-1](#) [S2-105Y0-Z1E0G](#)
[SIM28ML](#) [EWM-G110H01E](#) [WISE-4610P-NA](#) [M10578-A3](#) [M10578-A3-U2](#) [GPS-13740](#) [A2200-A](#) [MIKROE-4150](#) [28504](#) [L26ADR-S89](#)
[L26-M33](#) [L26T-S89](#) [L70B-M39](#) [L76L-M33](#) [L89-S90](#) [L96-M33](#) [S2-10640-Z1G0D](#) [EL.1A](#) [4037735105317](#) [4037735105331](#) [W2SG0084i-B-](#)
[T](#) [EWM-G108H01E](#) [TEL0132](#) [PKG300060P](#) [PKG300071](#) [PKG900000000271T](#) [RXM-GPS-F4-T](#) [RXM-GPS-FM-B](#) [A1084-A](#) [A2100-A](#)
[GPS-13670](#) [GYSFFMAXC](#)