



MAX-M8 series

u-blox M8 concurrent GNSS modules

Data Sheet



Abstract

Technical data sheet describing the MAX-M8 module series, which provides concurrent reception of up to 3 GNSS (GPS, Galileo, GLONASS, BeiDou) in a 9.7 x 10.1 mm package. It is pin-compatible to MAX-7 and MAX-6 modules.

Document Information

Title	MAX-M8 series	
Subtitle	u-blox M8 concurrent GNSS modules	
Document type	Data Sheet	
Document number	UBX-15031506	
Revision and date	R05	27-May-2019
Document status	Production Information	

Product status	Corresponding content status	
In Development / Prototype	Objective Specification	Target values. Revised and supplementary data will be published later.
Engineering Sample	Advance Information	Data based on early testing. Revised and supplementary data will be published later.
Initial Production	Early Production Information	Data from product verification. Revised and supplementary data may be published later.
Mass Production / End of Life	Production Information	Document contains the final product specification.

This document applies to the following products:

Product name	Type number	ROM/FLASH version	PCN reference
MAX-M8C	MAX-M8C-0-10	ROM SPG 3.01	UBX-16013125
MAX-M8Q	MAX-M8Q-0-10	ROM SPG 3.01	UBX-16013125
MAX-M8W	MAX-M8W-0-10	ROM SPG 3.01	UBX-16013125

u-blox or third parties may hold intellectual property rights in the products, names, logos and designs included in this document. Copying, reproduction, modification or disclosure to third parties of this document or any part thereof is only permitted with the express written permission of u-blox.

The information contained herein is provided "as is" and u-blox assumes no liability for its use. No warranty, either express or implied, is given, including but not limited to, with respect to the accuracy, correctness, reliability and fitness for a particular purpose of the information. This document may be revised by u-blox at any time without notice. For the most recent documents, visit www.u-blox.com.

Copyright © u-blox AG.

Contents

Document Information	2
Contents	3
1 Description	5
1.1 Overview	5
1.2 Product features	6
1.3 GNSS performance	7
1.4 Block diagram	8
1.5 Supported GNSS constellations	8
1.5.1 GPS	8
1.5.2 GLONASS	9
1.5.3 BeiDou	9
1.5.4 Galileo	9
1.6 Assisted GNSS (A-GNSS).....	9
1.6.1 AssistNow™ Online.....	9
1.6.2 AssistNow™ Offline	10
1.6.3 AssistNow™ Autonomous	10
1.7 Augmentation Systems	10
1.7.1 Satellite-Based Augmentation System (SBAS)	10
1.7.2 QZSS	10
1.7.3 IMES	11
1.7.4 Differential GPS (D-GPS).....	11
1.8 Odometer	11
1.9 Geofencing.....	11
1.10 Message Integrity Protection.....	11
1.11 Spoofing detection	12
1.12 Broadcast navigation data	12
1.13 EXTINT: External interrupt.....	12
1.13.1 Pin control	12
1.13.2 Aiding	12
1.14 TIMEPULSE	12
1.15 Protocols and interfaces	13
1.16 Interfaces.....	13
1.16.1 UART	13
1.16.2 Display Data Channel (DDC)	13
1.17 Clock generation.....	13
1.17.1 Oscillators	13
1.17.2 Real-Time Clock (RTC).....	13
1.18 Power management	14
1.18.1 DC-DC converter	14
1.18.2 Power Mode Setup.....	14

1.19 Antenna.....	15
1.19.1 Active antenna control (LNA_EN)	15
1.19.2 Antenna supervisor and short circuit detection	15
1.20 Configuration management	15
2 Pin definition	16
2.1 Pin assignment.....	16
2.2 Pin name changes.....	17
3 Electrical specification	18
3.1 Absolute maximum rating.....	18
3.2 Operating conditions.....	18
3.3 Indicative current requirements	20
4 Mechanical specifications	21
5 Reliability tests and approvals.....	22
5.1 Reliability tests.....	22
5.2 Approvals.....	22
6 Product handling & soldering.....	23
6.1 Packaging	23
6.1.1 Reels	23
6.1.2 Tapes.....	23
6.2 Shipment, storage and handling	24
6.2.1 Moisture Sensitivity Levels	24
6.2.2 Reflow soldering.....	24
6.2.3 ESD handling precautions	24
7 Default messages	26
8 Labeling and ordering information	27
8.1 Product labeling.....	27
8.2 Explanation of codes	27
8.3 Ordering codes.....	27
Appendix	28
A Glossary	28
Related documents	29
Revision history	29
Contact.....	30

1 Description

1.1 Overview

The MAX-M8 series of concurrent GNSS modules are built on the high performing u-blox M8 GNSS engine in the industry proven MAX form factor.

The modules can concurrently receive up to three GNSS systems (GPS/Galileo) together with BeiDou or GLONASS). The MAX-M8 modules recognize multiple constellations simultaneously and provide outstanding positioning accuracy in scenarios with urban canyon or weak signals. The modules offer high performance even at low power consumption levels. For even better and faster positioning improvement, the MAX-M8 modules support augmentation of QZSS and IMES together with WAAS, EGNOS, MSAS, and GAGAN.

The MAX-M8 modules support message integrity protection, Geofencing, and spoofing detection with configurable interface settings to easily fit to customer applications. The MAX form factor allows easy migration from previous MAX generations.

u-blox MAX-M8 modules use GNSS chips qualified according to AEC-Q100, are manufactured in ISO/TS 16949 certified sites, and fully tested on a system level. Qualification tests are performed as stipulated in the ISO16750 standard: “Road vehicles – Environmental conditions and testing for electrical and electronic equipment”.

MAX-M8 modules are available in three product variants:

- MAX-M8C is optimized for cost sensitive applications and has the lowest power consumption.
- MAX-M8Q provides best performance for passive and active antennas designs. It is also halogen free (green) which makes it perfectly suited for consumer applications.
- MAX-M8W provides best performance and is optimized for active antennas.

The modules combine a high level of integration capability with flexible connectivity options in a miniature package. This makes it perfectly suited for industrial applications with strict size and cost requirements. The I²C compatible DDC interface provides connectivity and enables synergies with most u-blox cellular modules.

The u-blox MAX-M8 modules can also benefit from the u-blox AssistNow assistance service. The Online service provides GNSS broadcast parameters, e.g. ephemeris, almanac plus time or rough position to reduce the receiver’s time to first fix significantly and improve acquisition sensitivity. The extended validity of AssistNow Offline data (up to 35 days) and AssistNow Autonomous data (up to 3 days) provide faster acquisition after a long off time.



See section [1.6](#) for more information concerning the MAX-M8 related AssistNow Assistance.

1.2 Product features

Model	Category	GNSS				Supply	Interfaces	Features	Grade
	Standard Precision GNSS High Precision GNSS Dead Reckoning Timing	GPS / QZSS GLONASS Galileo BeiDou	Number of concurrent GNSS		1.65 V – 3.6 V 2.7 V – 3.6 V	UART USB SPI	DDC (I ² C compliant) Programmable (flash) Data logging Additional SAW Additional LNA RTC crystal Oscillator Built-in antenna Built-in antenna supply and supervisor Timepulse	Standard Professional Automotive	
MAX-M8C	•	● ● ● ●	3	●	●	●	◆ C	1	●
MAX-M8Q	•	● ● ● ●	3	●	●	●	● T	1	●
MAX-M8W	•	● ● ● ●	3	●	●	●	● T	● 1	●

◆ = Yes, but with a higher backup content

C = Crystal / T = TCXO

1.3 GNSS performance

Parameter	Specification					
Receiver type	72-channel u-blox M8 engine GPS L1C/A, SBAS L1C/A, QZSS L1C/A, QZSS L1 SAIF, GLONASS L1OF, BeiDou B1I, Galileo E1B/C					
Velocity accuracy ¹	0.05 m/s					
Heading accuracy ¹	0.3 degrees					
Accuracy of time pulse signal	RMS	30 ns				
	99%	60 ns				
Frequency of time pulse signal	0.25 Hz... 10 MHz (configurable)					
Operational limits ²	Dynamics	≤ 4 g				
	Altitude	50,000 m				
	Velocity	500 m/s				
MAX-M8Q/W	GNSS	GPS & GLONASS	GPS	GLONASS	BEIDOU	GALILEO
Horizontal position accuracy ³		2.5 m	2.5 m	4 m	3 m	TBC ⁴
Max navigation update rate ⁵		10 Hz	18 Hz	18 Hz	18 Hz	18 Hz
Time-To-First-Fix ⁶	Cold start	26 s	29 s	30 s	34 s	45 s
	Hot start	1 s	1 s	1 s	1 s	1 s
	Aided starts ⁷	2 s	2 s	2 s	3 s	7 s
Sensitivity ⁸	Tracking & Navigation	-167 dBm	-166 dBm	-166 dBm	-160dBm	-159dBm
	Reacquisition	-160 dBm	-160 dBm	-156 dBm	-157dBm	-153dBm
	Cold start	-148 dBm	-148 dBm	-145 dBm	-143dBm	-138dBm
	Hot start	-157 dBm	-157 dBm	-156 dBm	-155dBm	-151dBm
MAX-M8C	GNSS	GPS & GLONASS	GPS	GLONASS	BEIDOU	GALILEO
Time-To-First-Fix ⁶	Cold start	26 s	30 s	31 s	39 s	57 s
	Hot start	1 s	1 s	1 s	1 s	1 s
	Aided starts ⁷	3 s	3 s	3 s	7 s	7 s
Sensitivity ⁸	Tracking & Navigation	-164 dBm	-164 dBm	-163 dBm	-160 dBm	-154 dBm
	Reacquisition	-160 dBm	-159 dBm	-156 dBm	-155 dBm	-152 dBm
	Cold start	-148 dBm	-147 dBm	-145 dBm	-143 dBm	-133 dBm
	Hot start	-157 dBm	-156 dBm	-155 dBm	-155 dBm	-151 dBm

Table 1: MAX-M8 indicative performance in different GNSS modes (default: concurrent reception of GPS & GLONASS including QZSS, SBAS)

¹ 50% @ 30 m/s

² Assuming Airborne < 4 g platform

³ CEP, 50%, 24 hours static, -130 dBm, > 6 SVs

⁴ To be confirmed when Galileo reaches full operational capability

⁵ Rates with SBAS and QZSS enabled for > 98% fix report rate under typical conditions

⁶ All satellites at -130 dBm, except Galileo at -127 dBm

⁷ Dependent on aiding data connection speed and latency

⁸ Demonstrated with a good external LNA

1.4 Block diagram

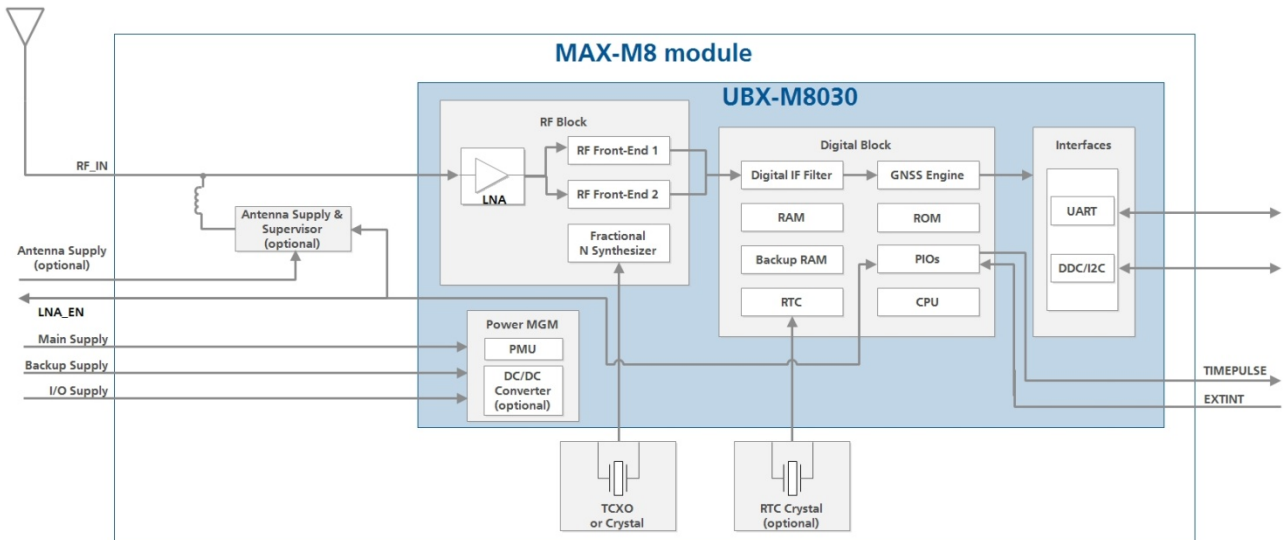

Figure 1: MAX-M8 block diagram

1.5 Supported GNSS constellations

The MAX-M8 GNSS modules are concurrent GNSS receivers that can receive and track multiple GNSS systems: GPS, Galileo, GLONASS and BeiDou. Owing to the dual-frequency RF front-end architecture, either GLONASS or BeiDou can be processed concurrently with GPS and Galileo signals providing reception of three GNSS systems. By default the M8 receivers are configured for concurrent GPS and GLONASS, including SBAS and QZSS reception. If power consumption is a key factor, then the receiver should be configured for a single GNSS operation using GPS, Galileo, GLONASS or BeiDou and disabling QZSS and SBAS. QZSS, IMES and SBAS, GAGAN augmentation systems share the same frequency band as GPS and can always be processed in conjunction with GPS.

The module can be configured to receive any single GNSS constellation or within the set of permissible combinations shown below.

GPS	Galileo	GLONASS	BeiDou
•	•	–	–
•	•	•	–
•	•	–	•
•	–	•	–
•	–	–	•
–	•	•	–
–	•	–	•
–	–	•	•

Table 2 Permissible GNSS combinations (• = enabled)

- The augmentation systems: SBAS and QZSS can be enabled only if GPS operation is configured.
- Galileo is not enabled as the default configuration.

1.5.1 GPS

The MAX-M8 positioning modules are designed to receive and track the L1C/A signals provided at 1575.42 MHz by the Global Positioning System (GPS). The MAX-M8 series can receive and process GPS concurrently with GLONASS or BeiDou.

1.5.2 GLONASS

The MAX-M8 modules can receive and process GLONASS concurrently with GPS or BeiDou. The Russian GLONASS satellite system is an alternative system to the US-based Global Positioning System (GPS). u-blox MAX-M8 positioning modules are designed to receive and track the L1OF signals GLONASS provided at $1602 \text{ MHz} + k \cdot 562.5 \text{ kHz}$, where k is the satellite's frequency channel number ($k = -7, \dots, 5, 6$). The ability to receive and track GLONASS L1OF satellite signals allows design of GLONASS receivers where required by regulations.



To take advantage of GPS and GLONASS, dedicated hardware preparation must be made during the design-in phase. See the u-blox 8 / u-blox M8 Receiver Description Including Protocol Specification [2] for u-blox design recommendations.

1.5.3 BeiDou

The MAX-M8 modules can receive and process the B1I signals broadcast at 1561.098 MHz from the BeiDou Navigation Satellite System. The ability to receive and track BeiDou signals in conjunction with another constellation results in higher coverage, improved reliability and better accuracy. Currently, BeiDou is not fully operational globally and provides Chinese regional coverage only. Global coverage is scheduled for 2020.

1.5.4 Galileo

The MAX-M8 positioning modules can receive and track the E1-B/C signals centered on the GPS L1 frequency band. GPS and Galileo signals can be processed concurrently together with either BeiDou or GLONASS signals, enhancing coverage, reliability and accuracy. The SAR return link message (RLM) parameters for both short and long versions are decoded by the receiver and made available to users via UBX proprietary messages.

-  Galileo has been implemented according to ICD release 1.2 (November 2015) and verified with live signals from the Galileo in-orbit validation campaign. Since the Galileo satellite system has not yet reached Initial (IOC) nor Full Operational Capability (FOC), changes to the Galileo signal specification (OS SIS ICD) remain theoretically possible.
-  Galileo reception is by default disabled, but can be enabled by sending a configuration message (UBX-CFG-GNSS) to the receiver. See the u-blox 8 / u-blox M8 Receiver Description Including Protocol Specification [2] for more information.

1.6 Assisted GNSS (A-GNSS)

Supply of aiding information, such as ephemeris, almanac, rough last position and time, will reduce the time to first fix significantly and improve the acquisition sensitivity. All u-blox M8030 based products support the u-blox AssistNow Online and AssistNow Offline A-GNSS services, support AssistNow Autonomous, and are OMA SUPL compliant.

1.6.1 AssistNow™ Online

With AssistNow Online, an internet-connected GNSS device downloads assistance data from the u-blox AssistNow Online Service at system start-up. AssistNow Online is network operator independent and globally available. u-blox only sends ephemeris data for those satellites currently visible to the device requesting the data, thus minimizing the amount of data transferred.

Supply of aiding information, such as ephemeris, almanac, rough last position and time, will reduce the time to first fix significantly and improve the acquisition sensitivity.

-  The AssistNow Online service provides data for GPS, GLONASS, BeiDou, Galileo and QZSS

1.6.2 AssistNow™ Offline

With AssistNow Offline, users download u-blox's long-term orbit data from the Internet at their convenience. The orbit data must be stored in the memory of the application processor. Thus the service requires no connectivity at system start-up and enables a position fix within seconds, even when no network is available. AssistNow Offline offers augmentation for up to 35 days.

 AssistNow Offline service provides data for GPS and GLONASS only, BeiDou and Galileo are not currently supported.

1.6.3 AssistNow™ Autonomous

AssistNow Autonomous provides aiding information without the need for a host or external network connection. Based on previous broadcast satellite ephemeris data downloaded to and stored by the GNSS receiver, AssistNow Autonomous automatically generates accurate predictions of satellite orbital data ("AssistNow Autonomous data") that is usable for future GNSS position fixes. The concept capitalizes on the periodic nature of GNSS satellites; by capturing strategic ephemeris data at specific times of the day, the receiver can predict accurate satellite ephemeris for up to 3 days after initial reception.

u-blox's AssistNow Autonomous benefits are:

- Faster fix in situations where GNSS satellite signals are weak
- No connectivity required
- Compatible with AssistNow Online (can work stand-alone, or in tandem with the AssistNow Online service)
- No integration effort; calculations are done in the background, transparent to the user.

 u-blox M8 ROM-based receivers, such as the MAX-M8 series, can use AssistNow Autonomous to calculate GPS only orbit predictions for up to 3 days. For best AssistNow Autonomous performance, it is recommended to use u-blox M8 flash-based receivers.

 For more details see the u-blox 8 / u-blox M8 Receiver Description Including Protocol Specification [2].

1.7 Augmentation Systems

1.7.1 Satellite-Based Augmentation System (SBAS)

u-blox M8 positioning modules support SBAS. These systems supplement GPS data with additional regional or wide area GPS augmentation data. The system broadcasts augmentation data via satellite and this information can be used by GNSS receivers to improve the resulting precision. SBAS satellites can be used as additional satellites for ranging (navigation), further enhancing precision and availability. The following SBAS types are supported with u-blox M8: GAGAN, WAAS, EGNOS and MSAS.

 For more details see the u-blox 8 / u-blox M8 Receiver Description Including Protocol Specification [2].



1.7.2 QZSS

The Quasi-Zenith Satellite System (QZSS) is a regional navigation satellite system that transmits additional GPS L1C/A signals for the Pacific region covering Japan and Australia. MAX-M8 positioning modules are able to receive and track these signals concurrently with GPS signals, resulting in better availability especially under challenging signal conditions, e.g. in urban canyons.

-  The L1- SAIF signal provided by QZSS can be enabled for reception via a GNSS configuration message.

1.7.3 IMES

The Japanese Indoor MESSaging System (IMES) system is used for indoor position reporting using low-power transmitters which broadcast a GPS-like signal. MAX-M8 modules can be configured to receive and demodulate the signal to provide an in-door location estimate.



-  This service is authorized and available only in Japan.
-  IMES reception is disabled by default

1.7.4 Differential GPS (D-GPS)

u-blox M8 receivers support Differential GPS data according RTCM 10402.3: "RECOMMENDED STANDARDS FOR DIFFERENTIAL GNSS". The use of Differential-GPS data improves GPS position accuracy. RTCM cannot be used together with SBAS. The RTCM implementation supports the following RTCM 2.3 messages:

Message Type	Description
1	Differential GPS Corrections
2	Delta Differential GPS Corrections
3	GPS Reference Station Parameters
9	GPS Partial Correction Set

Table 3: Supported RTCM 2.3 messages

-  For more details, see the u-blox 8 / u-blox M8 Receiver Description Including Protocol Specification [\[5\]](#).
-  RTCM corrections cannot be used together with SBAS.

1.8 Odometer

The odometer provides information on travelled ground distance (in meter) using solely the position and Doppler-based velocity of the navigation solution. For each computed travelled distance since the last odometer reset, the odometer estimates a 1-sigma accuracy value. The total cumulative ground distance is maintained and saved in the BBR memory.

-  The odometer feature is disabled by default. For more details, see the u-blox 8 / u-blox M8 Receiver Description Including Protocol Specification [\[2\]](#).

1.9 Geofencing

The u-blox MAX-M8 modules support up to four circular Geofencing areas defined on the Earth's surface using a 2D model. Geofencing is active when at least one Geofence is defined, the current status can be found by polling the receiver.

1.10 Message Integrity Protection

The MAX-M8 modules provide a function to prevent a third party interfering with the UBX message stream sent from receiver to host. The security mechanism essentially 'signs' nominated messages with a following message containing an md5 generated hash of the nominated message. This message signature is then compared with one generated by the host to determine if the message

data has been altered. The hash algorithm seed can use one fixed secret ID-key set by eFuse in production or a dynamic ID-key set by host enabling users to detect ‘Man-in-the-middle’ style attacks.

1.11 Spoofing detection

Spoofing is a process whereby a malicious third party tries to control the reported position via a “fake” GNSS broadcast signal. This may result in the form of reporting incorrect position, velocity or time. To combat against this the MAX-M8 modules include anti-spoofing measures to alert the host when signals appear to be suspicious. The receiver combines a number of checks on the received signals looking for inconsistencies across several parameters.

 This feature does not guarantee detection of all spoofing attacks

1.12 Broadcast navigation data

The MAX-M8 can output all the GNSS broadcast data upon reception from tracked satellites. This includes all the supported GNSS signals plus the augmentation services SBAS, QZSS and IMES. The receiver also makes available the tracked satellite signal information, i.e. raw code phase and Doppler measurements in a form aligned to the ETSI mobile cellular location services protocol (RRLP) [6]. For more details, see the u-blox 8 / u-blox M8 Receiver Description Including Protocol Specification [2].

1.13 EXTINT: External interrupt

EXTINT is an external interrupt pin with fixed input voltage thresholds with respect to **VCC_IO**. It can be used for control of the receiver or for aiding.

For more information on how to implement and configure these features see the u-blox 8 / u-blox M8 Receiver Description including Protocol Specification [2] and the MAX-8 / MAX-M8 Hardware Integration Manual [1].

1.13.1 Pin control

The pin control feature allows overriding the automatic active/inactive cycle of Power Save Mode. The state of the receiver can be controlled through the **EXTINT** pin. The receiver can also be turned off and sent into Backup Mode using **EXTINT** when Power Save Mode is not active.

1.13.2 Aiding

The **EXTINT** pin can be used to supply time or frequency aiding data to the receiver.

For time aiding, hardware time synchronization can be achieved by connecting an accurate time pulse to the **EXTINT** pin.

Frequency aiding can be implemented by connecting a periodic rectangular signal with a frequency up to 500 kHz and arbitrary duty cycle (low/high phase duration must not be shorter than 50 ns) to the **EXTINT** pin, and providing the applied frequency value to the receiver using UBX messages.

1.14 TIMEPULSE

A configurable time pulse signal is available with all u-blox M8 modules.

The **TIMEPULSE** output generates pulse trains synchronized with a GNSS or UTC time grid, with intervals configurable over a wide frequency range. Thus it may be used as a low frequency time synchronization pulse or as a high frequency reference signal.

By default the time pulse signal is configured to 1 pulse per second. For more information, see the u-blox 8 / u-blox M8 Receiver Description Including Protocol Specification [2].

1.15 Protocols and interfaces

Protocol	Type
NMEA 0183, version 4.0 (V2.1, V2.3 or V4.1 configurable)	Input/output, ASCII
UBX	Input/output, binary, u-blox proprietary
RTCM	Input, message 1, 2, 3, 9

Table 4: Available protocols

All protocols are available on UART and DDC (I²C compliant). For specification of the various protocols, see the u-blox 8 / u-blox M8 Receiver Description Including Protocol Specification [2].

1.16 Interfaces

A number of interfaces are provided either for data communication or memory access. The embedded firmware uses these interfaces according to their respective protocol specifications.

1.16.1 UART

MAX-M8 modules include one UART interface, which can be used for communication to a host. It supports configurable baud rates. For supported baud rates, see the u-blox 8 / u-blox M8 Receiver Description Including Protocol Specification [2].

 Designs must allow access to the UART and the **SAFEBOOT_N** function pin for future service, updates and reconfiguration.

1.16.2 Display Data Channel (DDC)

An I²C compliant DDC interface is available for communication with an external host CPU or u-blox cellular modules. The interface can be operated in slave mode only. The DDC protocol and electrical interface are fully compatible with the Fast-Mode of the I²C industry standard. Since the maximum SCL clock frequency is 400 kHz, the maximum transfer rate is 400 kb/s.

The DDC interface is I²C Fast Mode compliant. For timing parameters consult the I²C standard.

 The maximum bit rate is 400 kb/s. The interface stretches the clock when slowed down while serving interrupts, so real bit rates may be slightly lower.

1.17 Clock generation

1.17.1 Oscillators

MAX-M8 concurrent GNSS modules are available in Crystal and TCXO versions. The TCXO option allows accelerated weak signal acquisition, enabling faster start and reacquisition times.

1.17.2 Real-Time Clock (RTC)

The RTC is driven by a 32 kHz oscillator, which makes use of an RTC crystal. If the main supply voltage fails and a battery is connected to **V_BCKP**, parts of the receiver switch off, but the RTC still runs providing a timing reference for the receiver. This operating mode is called Hardware Backup Mode, which enables all relevant data to be saved in the backup RAM to allow a hot or warm start later.

With MAX-M8C in Hardware Backup Mode, the main oscillator is used as timing reference instead of the 32 kHz oscillator. The MAX-M8C applies single crystal mode, where the 26 MHz crystal oscillator can also be used to provide a frequency reference to the RTC without using an additional crystal for the RTC. This makes MAX-M8C a more cost efficient solution at the expense of a higher backup current.

 For more information, see the MAX-8 / MAX-M8 Hardware Integration Manual [1].

1.18 Power management

u-blox M8 technology offers a power optimized architecture with built-in autonomous power saving functions to minimize power consumption at any given time. Furthermore, the receiver can be used in two operating modes: Continuous mode for best performance or Power Save Mode for optimized power consumption respectively. In addition, a high efficiency DC/DC converter is integrated to allow low power consumption even for higher main supply voltages.

1.18.1 DC-DC converter

MAX-M8Q and MAX-M8C modules integrate a DC-DC converter, allowing reduced power consumption by up to 50%.

 For more information, see the MAX-8 / MAX-M8 Hardware Integration Manual [1].

1.18.2 Power Mode Setup

u-blox M8 modules can be configured to run in either continuous or a choice of Power Save mode configurations. A template of power mode settings can be used to easily select typical power mode setups to cover the majority of users' requirements.

- Continuous (default) mode for best GNSS performance vs power consumption
- A 1 Hz cyclic tracking mode for aggressive power reduction
- Choice of 2 or 4 Hz⁹ cyclic tracking modes for typical wearable applications
- ON/OFF interval mode

1.18.2.1 Continuous Mode

Continuous Mode uses the acquisition engine at full performance, resulting in the shortest possible TTFF and the highest sensitivity. The receiver searches for all possible satellites until the almanac is completely downloaded. The receiver then switches to the tracking engine to lower the power consumption.

Thus, a lower tracking current consumption level will be achieved when:

- A valid GNSS position is obtained
- The entire almanac has been downloaded
- The ephemeris for each satellite in view is valid

1.18.2.2 Power Save Mode

For power sensitive applications, u-blox M8 receivers provide a Power Save Mode for reduced power consumption.

Power Save Mode provides two dedicated methods, ON/OFF and Cyclic tracking, that reduce average current consumption in different ways to match the needs of the specific application. These options can be set by using a specific UBX message.

 For more information about power management strategies, see the u-blox 8 / u-blox M8 Receiver Description Including Protocol Specification [2].

⁹ Single GNSS constellation configuration only

1.19 Antenna

MAX-M8 modules are designed for use with passive ¹⁰ and active ¹¹ antennas.

Parameter	Specification	
Antenna type	Passive and active antenna	
Active antenna recommendations	Minimum gain	15 dB (to compensate signal loss in RF cable)
	Maximum gain	50 dB
	Maximum noise figure	1.5 dB

Table 5: Antenna Specifications for all MAX-M8 modules

1.19.1 Active antenna control (LNA_EN)

The **LNA_EN** Pin can be used to turn on and off an external LNA or an active antenna. This reduces power consumption in Power Save Mode (Backup mode). This pin is available only on MAX-M8C and MAX-M8Q.

1.19.2 Antenna supervisor and short circuit detection

An antenna supervisor is available with MAX-M8W. The antenna supervisor enables the receiver to detect short circuits (**ANT_OK**) at the active antenna and shut down the voltage bias immediately. A resistor is needed in series with the **V_ANT** input to enable checking of the antenna bias voltage. UBX and NMEA messages are provided to report the condition of the antenna supply. Open circuit detection can also be supported with an additional external circuit.

 Antenna open circuit detection (**ANT_DET**) can be mapped to PIO13 and requires external components

 For more information, see the MAX-8 / MAX-M8 Hardware Integration Manual [1].

1.20 Configuration management

Configuration settings can be modified with UBX configuration messages. The modified settings remain effective until power-down or reset. If these settings have been stored in battery-backup RAM, then the modified configuration will be retained, as long as the backup battery supply is not interrupted.

 For more information about configuration management, see the u-blox 8 / u-blox M8 Receiver Description Including Protocol Specification [2].

¹⁰ For integration MAX-M8 modules with Cellular products, see the MAX-8 / MAX-M8 Hardware Integration Manual [1].

¹¹ For information on using active antennas with MAX-M8 modules, see the MAX-8 / MAX-M8 Hardware Integration Manual [1].

2 Pin definition

2.1 Pin assignment

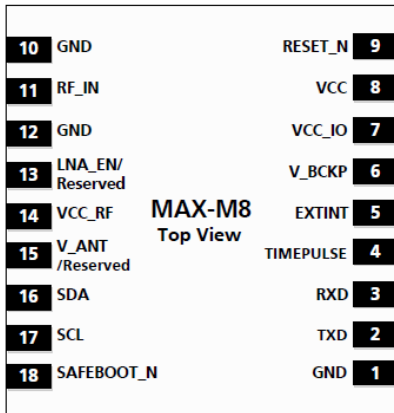



Figure 2: Pin assignment

No	Module	Name	PIO ¹² No.	I/O	Description
1	All	GND	-		Ground
2	All	TXD	6	O	Serial Port
3	All	RXD	7	I	Serial Port
4	All	TIMEPULSE	11	O	Time pulse (1PPS)
5	All	EXTINT	13	I	External Interrupt Pin
6	All	V_BCKP	-		Backup voltage supply
7	All	VCC_IO	-		IO Supply Voltage
8	All	VCC	-		Supply voltage
9	All	RESET_N	-	I	RESET_N
10	All	GND	-		Ground
11	All	RF_IN	-	I	GNSS signal input
12	All	GND	-		Ground
13	MAX-M8C/Q	LNA_EN	16	O	Antenna control
	MAX-M8W	Reserved	-	-	Reserved
14	All	VCC_RF	-		Output Voltage RF section
15	MAX-M8W	V_ANT	-		Active Antenna Supply Voltage
	MAX-M8C/Q	Reserved	-	-	Reserved
16	All	SDA	9	I/O	DDC Data
17	All	SCL	8	I/O	DDC Clock
18	All	SAFEBOOT_N	-	I	SAFEBOOT_N (for reconfiguration, leave OPEN)

Table 6: Pinout

Antenna open circuit detection (ANT_DET) can be mapped to PIO13 and requires external components. MAX-M8W does not have a dedicated ANT_DET pin. The ANT_DET pin can be made available on the EXTINT pin. For more information, see the MAX-8 / MAX-M8 Hardware Integration Manual [1].

¹² Peripheral Input Output

 Pins designated as “Reserved” should not be used. For more information about pinouts, see the MAX-8 / MAX-M8 Hardware Integration Manual [1].

2.2 Pin name changes

Selected pin names have been updated to agree with a common naming convention across u-blox modules. The pins have not changed their operation and are the same physical hardware but with updated names. The table below lists the pins that have changed name along with their old and new names.

No	Previous Name	New name
13	ANT_ON	LNA_EN
5	EXTINT0	EXTINT
18	Reserved	SAFEBOOT_N

Table 7: Pin name change list

3 Electrical specification

The limiting values given are in accordance with the Absolute Maximum Rating System (IEC 134). Stress above one or more of the limiting values may cause permanent damage to the device. These are stress ratings only, and operation of the device at these or at any other conditions above those given in the Characteristics sections of the specification is not implied. Exposure to these limits for extended periods may affect device reliability.

Where application information is given, it is advisory only and does not form part of the specification. For more information, see the MAX-8 / MAX-M8 Hardware Integration Manual [1].

3.1 Absolute maximum rating

Parameter	Symbol	Module	Condition	Min	Max	Units
Power supply voltage	VCC, VCC_IO	All		-0.5	3.6	V
Backup battery voltage	V_BCKP	All		-0.5	3.6	V
Input pin voltage	V _{in}	All	If VCC_IO < 3.1V	-0.5	VCC_IO+0.5	V
			If VCC_IO > 3.1V	-0.5	3.6	V
DC current through any digital I/O pin (except supplies)	I _{pin}				10	mA
VCC_RF output current	ICC_RF	All			100	mA
Input power at RF_IN	Pr _{fin}	All	source impedance = 50 Ω, continuous wave		15	dBm
Antenna bias voltage	V_ANT				6	V
Antenna bias current	I_ANT				100	mA
Storage temperature	T _{stg}	MAX-M8C		-40	105	°C
		MAX-M8Q/M8W		-40	85	°C

Table 8: Absolute maximum ratings

Stressing the device beyond the “Absolute Maximum Ratings” may cause permanent damage. These are stress ratings only. The product is not protected against overvoltage or reversed voltages. If necessary, voltage spikes exceeding the power supply voltage specification, given in table above, must be limited to values within the specified boundaries by using appropriate protection diodes.

3.2 Operating conditions

All specifications are at an ambient temperature of +25 °C. Extreme operating temperatures can significantly impact specification values. Applications operating near the temperature limits should be tested to ensure the specification.

Parameter	Symbol	Module	Min	Typ	Max	Units	Condition
Power supply voltage	VCC, VCC_IO	MAX-M8C	1.65	3.0	3.6	V	
		MAX-M8Q/W	2.7	3.0	3.6	V	
Backup battery voltage	V_BCKP	All	1.4		3.6	V	
Backup battery current	I_BCKP	MAX-M8Q/W		15		μA	V_BCKP = 3.0 V, VCC = 0 V
		MAX-M8C		100		μA	V_BCKP = 3.0 V, VCC = 0 V
SW backup current	I_SWBCKP	MAX-M8Q/W		30		μA	VCC = 3.0 V
		MAX-M8C		105		μA	VCC = 3.0 V
Input pin voltage range ¹³	V _{in}	All	0		VCC_IO+0.5	V	
Digital IO Pin Low level input voltage	V _{il}	All	0		0.2*VCC_IO	V	
Digital IO Pin High level input voltage	V _{ih}	All	0.7*VCC_IO		VCC_IO+0.5	V	
Digital IO Pin Low level output voltage	V _{ol}	All			0.4	V	I _{ol} =4 mA
Digital IO Pin High level output voltage	V _{oh}	All	VCC_IO - 0.4			V	I _{oh} =4 mA
Pull-up resistor for RESET_N (Internal)	R _{pu}	All		11		kΩ	
V_ANT antenna bias voltage	V_ANT	2.7			5.5	V	I _{ANT} < -50 mA
Antenna bias voltage drop	V_ANT_DROP		0.1			V	ICC_RF = 50 mA
VCC_RF voltage	VCC_RF	All		VCC - 0.1		V	
VCC_RF output current	ICC_RF	All			50	mA	
Receiver Chain Noise Figure ¹⁴	NF _{tot}	All		3.5		dB	
Operating temperature	T _{opr}	All	-40		85	°C	

Table 9: Operating conditions



Operation beyond the specified operating conditions can affect device reliability.

¹³ If VCC or VCC_IO is 0V there should not be any voltage applied to any I/O (Including RESET_N)

¹⁴ Only valid for the GPS band



3.3 Indicative current requirements

Table 10 lists examples of the total system supply current for a possible application.

 Values in Table 10 are provided for customer information only as an example of typical power requirements. Values are characterized on samples. Actual power requirements can vary depending on FW version used, external circuitry, the number of SVs tracked, signal strength, type of start as well as time, duration and conditions of test.

Parameter	Symbol	Module	Typical GPS / GLONASS / QZSS / SBAS	Typical GPS / QZSS / SBAS	Max	Units	Condition
Max. supply current ¹⁵	Iccp	All			67	mA	Estimated at 3 V
Average supply current ^{16, 17}	Icc Acquisition ¹⁸	MAX-M8C	26	20		mA	Estimated at 3 V
		MAX-M8W	43	32		mA	Estimated at 3 V
		MAX-M8Q	26	20		mA	Estimated at 3 V
	Icc Tracking (Continuous mode)	MAX-M8C	23	17		mA	Estimated at 3 V
		MAX-M8W	38	30		mA	Estimated at 3 V
		MAX-M8Q	23	18		mA	Estimated at 3 V
	Icc Tracking (Power Save mode/ 1 Hz)	MAX-M8C	5.4	4.9		mA	Estimated at 3 V
		MAX-M8W	9.7	8.9		mA	Estimated at 3 V
		MAX-M8Q	6.2	5.7		mA	Estimated at 3 V

Table 10: MAX-M8C/W/Q indicative power requirements at 3.0 V

-  For more information about power requirements, see the MAX-8 / MAX-M8 Hardware Integration Manual [1].
-  For more information on how to noticeably reduce current consumption, see the Power Management Application Note [3].

¹⁵ Use this figure to dimension maximum current capability of power supply. Measure this parameter with 1 Hz bandwidth.

¹⁶ Use this figure to determine required battery capacity.

¹⁷ Simulated GNSS constellation using power levels of -130 dBm. VCC= 3.0 V

¹⁸ Average current from start-up until the first fix.

4 Mechanical specifications

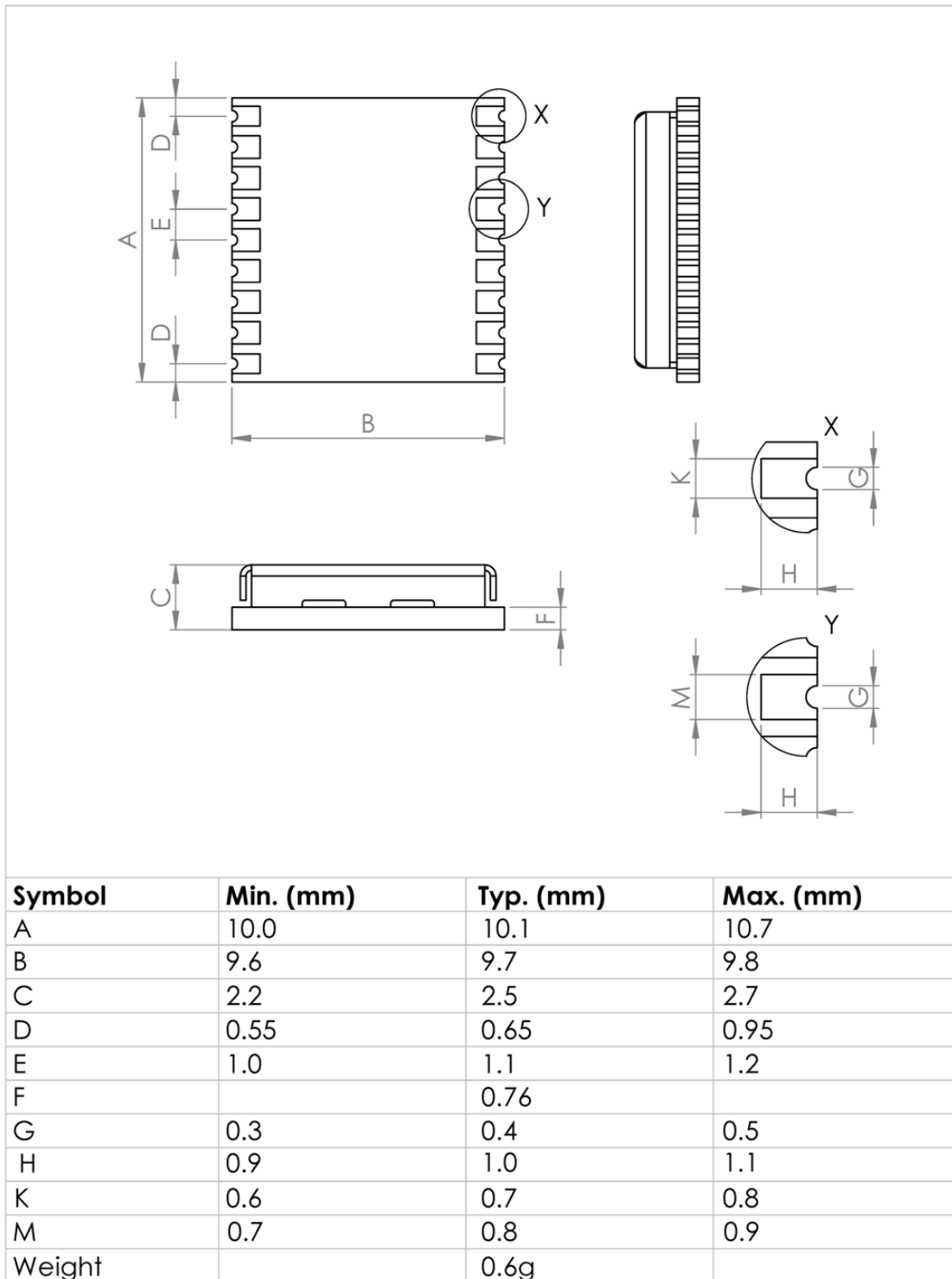



Figure 3: Dimensions

For information about the paste mask and footprint, see the MAX-8 / MAX-M8 Hardware Integration Manual [1].

5 Reliability tests and approvals

5.1 Reliability tests

 All MAX-M8 modules are based on AEC-Q100 qualified GNSS chips.

Tests for product family qualifications are according to ISO 16750 "Road vehicles – Environmental conditions and testing for electrical and electronic equipment", and appropriate standards.

5.2 Approvals



The MAX-M8C, MAX-M8Q, and MAX-M8W modules comply with the Directives 2011/65/EU and 2015/863/EU of the European Parliament and the Council on the Restriction of Use of certain Hazardous Substances (RoHS).

6 Product handling & soldering

6.1 Packaging

MAX-M8 modules are delivered as hermetically sealed, reeled tapes in order to enable efficient production, production lot set-up and tear-down. For more information, see the u-blox Package Information Guide [5].

6.1.1 Reels

MAX-M8 GNSS modules are deliverable in quantities of 500 pieces on a reel. MAX-M8 modules are shipped on Reel Type B, as specified in the u-blox Package Information Guide [5].

6.1.2 Tapes

Figure 4 shows the position and orientation of MAX-M8 modules as they are delivered on tape. The dimensions of the tapes are specified in Figure 5.

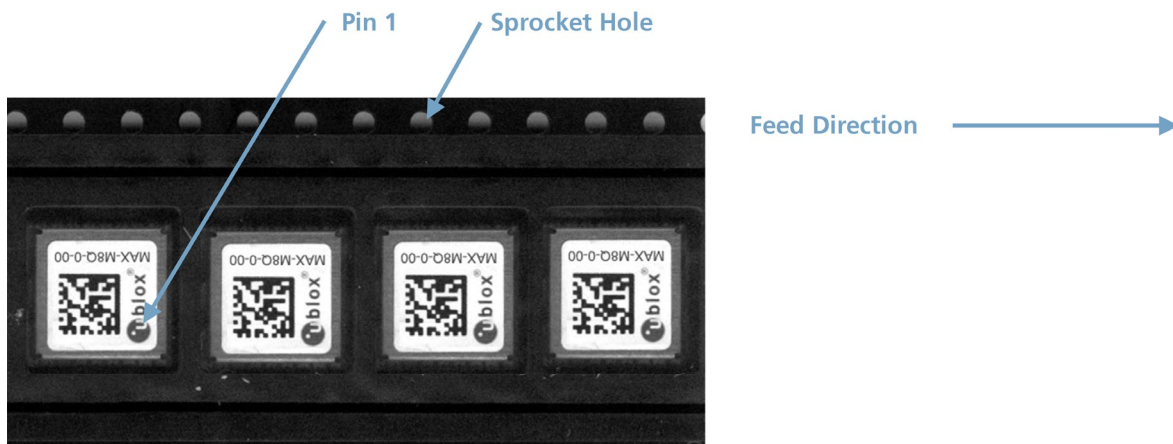

Figure 4: Tape and module orientation

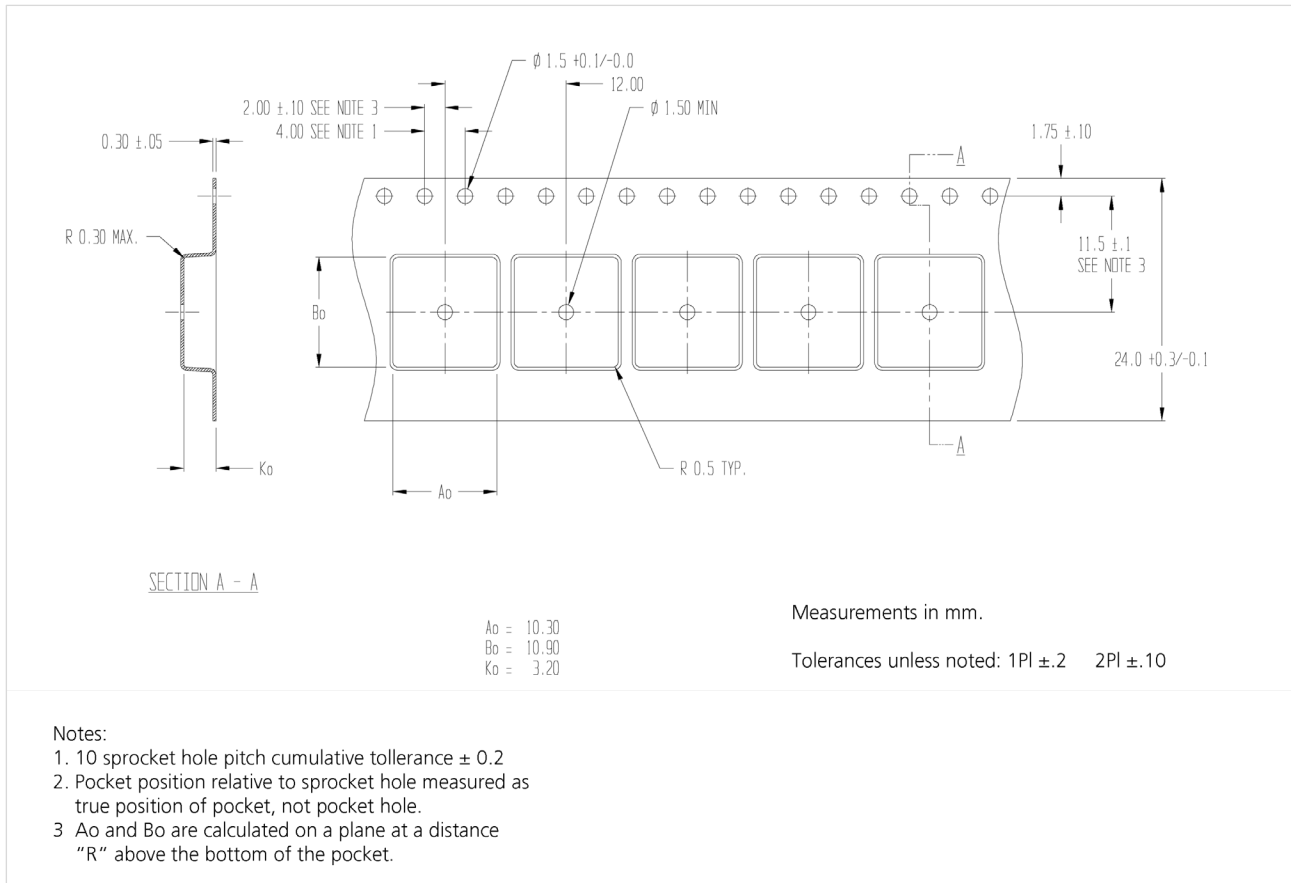

Figure 5: MAX-M8 Tape dimensions

6.2 Shipment, storage and handling

For more information regarding shipment, storage and handling, see the u-blox Package Information Guide [5].

6.2.1 Moisture Sensitivity Levels

The Moisture Sensitivity Level (MSL) relates to the packaging and handling precautions required. MAX-M8 modules are rated at MSL level 4.

For MSL standard, see IPC/JEDEC J-STD-020, which can be downloaded from www.jedec.org.

6.2.2 Reflow soldering

Reflow profiles are to be selected according to the u-blox recommendations (see the MAX-8 / MAX-M8 Hardware Integration Manual [1]).

6.2.3 ESD handling precautions

MAX-M8 modules are Electrostatic Sensitive Devices (ESD). Observe precautions for handling! Failure to observe these precautions can result in severe damage to the GNSS receiver!

GNSS receivers are Electrostatic Sensitive Devices (ESD) and require special precautions when handling. Particular care must be exercised when handling patch antennas, due to the risk of electrostatic charges. In addition to standard ESD safety practices, the following measures should be taken into account whenever handling the receiver:

- Unless there is a galvanic coupling between the local GND (i.e. the work table) and the PCB GND, then the first point of contact when handling the PCB must always be between the local GND and PCB GND.
- Before mounting an antenna patch, connect ground of the device
- When handling the RF pin, do not come into contact with any charged capacitors and be careful when contacting materials that can develop charges (e.g. patch antenna ~10 pF, coax cable ~50 to 80 pF/m, soldering iron, ...)
- To prevent electrostatic discharge through the RF input, do not touch any exposed antenna area. If there is any risk that such exposed antenna area is touched in non ESD protected work area, implement proper ESD protection measures in the design.
- When soldering RF connectors and patch antennas to the receiver's RF pin, make sure to use an ESD safe soldering iron (tip).

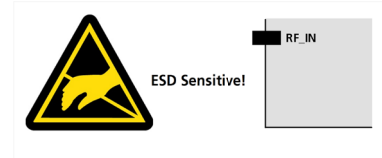

7 Default messages

Interface	Settings
UART Output	9600 baud, 8 bits, no parity bit, 1 stop bit Configured to transmit both NMEA and UBX protocols, but only the following NMEA (and no UBX) messages have been activated at start-up: GGA, GLL, GSA, GSV, RMC, VTG, TXT
UART Input	9600 baud, 8 bits, no parity bit, 1 stop bit, autobauding disabled Automatically accepts following protocols without need of explicit configuration: UBX, NMEA, RTCM The GNSS receiver supports interleaved UBX and NMEA messages.
DDC	Fully compatible with the I ² C industry standard, available for communication with an external host CPU or u-blox cellular modules; operated in slave mode only. NMEA and UBX are enabled as input messages, only NMEA as output messages Maximum bit rate 400 kb/s.
TIMEPULSE (1Hz Nav)	1 pulse per second, synchronized at rising edge, pulse length 100 ms

Table 11: Default messages

 Refer to the u-blox 8 / u-blox M8 Receiver Description including Protocol Specification [2] for information about other settings.

8 Labeling and ordering information

8.1 Product labeling

The labeling of u-blox M8 GNSS modules includes important product information. The location of the product type number is shown in [Figure 6](#).

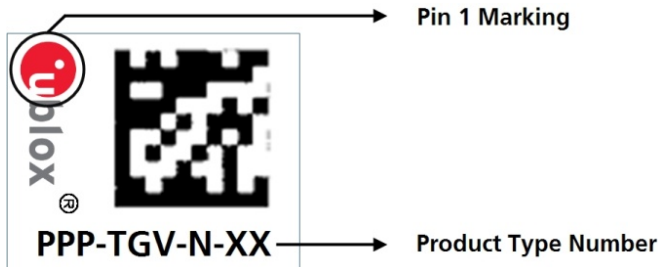

Figure 6: Location of product type number on MAX-M8 module label

8.2 Explanation of codes

Three different product code formats are used. The **Product Name** is used in documentation such as this data sheet and identifies all u-blox M8 products, independent of packaging and quality grade. The **Ordering Code** includes options and quality, while the **Type Number** includes the hardware and firmware versions. [Table 12](#) shows the structure of these three different formats.

Format	Structure
Product Name	PPP-TGV
Ordering Code	PPP-TGV-N
Type Number	PPP-TGV-N-XX

Table 12: Product code formats

The parts of the product code are explained in [Table 13](#).

Code	Meaning	Example
PPP	Product Family	MAX
TG	Product Generation	M8 = u-blox M8
V	Variant	Function set (A-Z), T = Timing, R = DR, etc.
N	Option / Quality Grade	Describes standardized functional element or quality grade 0 = Default variant, A = Automotive
XX	Product Detail	Describes product details or options, such as hardware or software revision, cable length, etc.

Table 13: Part identification code

8.3 Ordering codes

Ordering No.	Product
MAX-M8C-0	u-blox M8 concurrent GNSS LCC Module, Crystal, ROM, 9.7x10.1 mm, 500 pieces/reel
MAX-M8Q-0	u-blox M8 concurrent GNSS LCC Module, TCXO, ROM, Green, 9.7x10.1 mm, 500 pieces/reel
MAX-M8W-0	u-blox M8 concurrent GNSS LCC Module, TCXO, Active Antenna Supply, ROM, 9.7x10.1 mm, 500 pieces/reel

Table 14: Product ordering codes for professional grade modules

Product changes affecting form, fit or function are documented by u-blox. For a list of Product Change Notifications (PCNs), see our website.

Appendix

A Glossary

Abbreviation	Definition
AEC	Automotive Electronics Council
BBR	Battery Backed RAM
DDC	Display Data Channel
EGNOS	European Geostationary Navigation Overlay Service
ESD	Electrostatic Sensitive Device*
FOC	Full Operational Capability
GAGAN	GPS Aided GEO Augmented Navigation
GLONASS	GLObal Navigation Satellite System (Russian)
GNSS	Global Navigation Satellite System
GPIO	General Purpose Input/Output
GPS	Global Positioning System
IMES	Indoor MESSaging System
I2C	Inter-Integrated Circuit
IEC	International Electrotechnical Commission
ISO	International Organization for Standardization
LCC	Leadless Chip Carrier
LCS	LoCation Services (protocol)
LNA	Low Noise Amplifier
MSAS	MTSAT Satellite Augmentation System
MSL	Moisture Sensitivity Level
NMEA	National Marine Electronics Association
PPP	Point-to-Point Protocol* / Precise Point Positioning*
PCB	Printed Circuit Board
PCN	Product Change Notification
PPS	Pulse Per Second
QZSS	Quasi-Zenith Satellite System
RLM	Return Link Message
RRLP	Radio Resource LCS Protocol
RTC	Real Time Clock
RTCM	Radio Technical Commission for Maritime Services
SAW	Surface Acoustic Wave
SBAS	Satellite-Based Augmentation System
SCL	Serial Clock
SMD	Solder Mask Defined
SUPL	Secure User Plane Location
TCXO	Temperature-Compensated Crystal Oscillator
TTF	Time-To-First-Fix
UART	Universal Asynchronous Receiver/Transmitter
UTC	Coordinated Universal Time
WAAS	Wide Area Augmentation System

Table 15: Explanation of the abbreviations and terms used

Related documents

- [1] MAX-8 / MAX-M8 Hardware Integration Manual, Doc. No. [UBX-15030059](#)
- [2] u-blox 8 / u-blox M8 Receiver Description including Protocol Specification (public version), Doc. No. [UBX-13003221](#)
- [3] Power Management Application Note, Doc. No. [UBX-13005162](#)
- [4] RTCM 10402.3 Recommended Standards for Differential GNSS, Ver. 2.3, RTCM Aug. 20, 2001
- [5] u-blox Package Information Guide, Doc. No. [UBX-14001652](#)
- [6] Radio Resource LCS Protocol (RRLP), (3GPP TS 44.031 version 11.0.0 Release 11)

 For regular updates to u-blox documentation and to receive product change notifications, register on our homepage (www.u-blox.com).

Revision history

Revision	Date	Name	Comments
R01	2-Jun-2016	ghun	Advance Information
R02	15-Aug-2016	ghun	Production Information
R03	28-Feb-2018	mbab	Rebranding
R04	30-Jan-2019	yzha	Updated Section 5.2(RoHS statement).
R05	27-May-2019	yzha	Updated Vin Absolute Maximum Rating

Contact

For complete contact information, visit us at www.u-blox.com.

u-blox Offices

North, Central and South America

u-blox America, Inc.

Phone: +1 703 483 3180
E-mail: info_us@u-blox.com

Regional Office West Coast:

Phone: +1 408 573 3640
E-mail: info_us@u-blox.com

Technical Support:

Phone: +1 703 483 3185
E-mail: support@u-blox.com

Headquarters

Europe, Middle East, Africa

u-blox AG

Phone: +41 44 722 74 44
E-mail: info@u-blox.com
Support: support@u-blox.com

Asia, Australia, Pacific

u-blox Singapore Pte. Ltd.

Phone: +65 6734 3811
E-mail: info_ap@u-blox.com
Support: support_ap@u-blox.com

Regional Office Australia:

Phone: +61 2 8448 2016
E-mail: info_anz@u-blox.com
Support: support_ap@u-blox.com

Regional Office China (Beijing):

Phone: +86 10 68 133 545
E-mail: info_cn@u-blox.com
Support: support_cn@u-blox.com

Regional Office China (Chongqing):

Phone: +86 23 6815 1588
E-mail: info_cn@u-blox.com
Support: support_cn@u-blox.com

Regional Office China (Shanghai):

Phone: +86 21 6090 4832
E-mail: info_cn@u-blox.com
Support: support_cn@u-blox.com

Regional Office China (Shenzhen):

Phone: +86 755 8627 1083
E-mail: info_cn@u-blox.com
Support: support_cn@u-blox.com

Regional Office India:

Phone: +91 80 405 092 00
E-mail: info_in@u-blox.com
Support: support_in@u-blox.com

Regional Office Japan (Osaka):

Phone: +81 6 6941 3660
E-mail: info_jp@u-blox.com
Support: support_jp@u-blox.com

Regional Office Japan (Tokyo):

Phone: +81 3 5775 3850
E-mail: info_jp@u-blox.com
Support: support_jp@u-blox.com

Regional Office Korea:

Phone: +82 2 542 0861
E-mail: info_kr@u-blox.com
Support: support_kr@u-blox.com

Regional Office Taiwan:

Phone: +886 2 2657 1090
E-mail: info_tw@u-blox.com
Support: support_tw@u-blox.com

X-ON Electronics

Largest Supplier of Electrical and Electronic Components

Click to view similar products for [GPS Modules](#) category:

Click to view products by [U-Blox](#) manufacturer:

Other Similar products are found below :

[EWM-G109H01E](#) [ISM3333-C6.1](#) [GPS-11858](#) [SL871GPS232R001](#) [DD-14239](#) [GPS-10922](#) [M20050-1](#) [M20048-1](#) [S2-105Y0-Z1E0G](#)
[SIM28ML](#) [EWM-G110H01E](#) [WISE-4610P-NA](#) [M10578-A3](#) [M10578-A3-U2](#) [GPS-13740](#) [A2200-A](#) [MIKROE-4150](#) [28504](#) [L26ADR-S89](#)
[L26-M33](#) [L26T-S89](#) [L70B-M39](#) [L76L-M33](#) [L89-S90](#) [L96-M33](#) [S2-10640-Z1G0D](#) [EL.1A](#) [4037735105317](#) [4037735105331](#) [W2SG0084i-B-](#)
[T](#) [EWM-G108H01E](#) [TEL0132](#) [PKG300060P](#) [PKG300071](#) [PKG900000000271T](#) [RXM-GPS-F4-T](#) [RXM-GPS-FM-B](#) [A1084-A](#) [A2100-A](#)
[GPS-13670](#) [GYSFFMAXC](#)