

# NINA-B1 series

## Stand-alone Bluetooth low energy modules

### Data Sheet

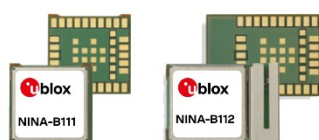

### Abstract

This technical data sheet describes the NINA-B1 series stand-alone Bluetooth® low energy modules. With embedded Bluetooth low energy stack and u-blox connectivity software, these modules are tailored for OEMs who wish to have the shortest time-to-market. The OEMs can also embed their own application on top of the integrated Bluetooth low energy stack using Nordic SDK or Arm® Mbed™ integrated development environment (IDE).

# Document Information

<b>Title</b>	<b>NINA-B1 series</b>	
<b>Subtitle</b>	Stand-alone Bluetooth low energy modules	
<b>Document type</b>	Data Sheet	
<b>Document number</b>	UBX-15019243	
<b>Revision and date</b>	R12	2-Jan-2019
<b>Disclosure Restriction</b>		

<b>Product status</b>	<b>Corresponding content status</b>	
<b>Functional Sample</b>	Draft	For functional testing. Revised and supplementary data will be published later.
<b>In Development / Prototype</b>	Objective Specification	Target values. Revised and supplementary data will be published later.
<b>Engineering Sample</b>	Advance Information	Data based on early testing. Revised and supplementary data will be published later.
<b>Initial Production</b>	Early Production Information	Data from product verification. Revised and supplementary data may be published later.
<b>Mass Production / End of Life</b>	Production Information	Document contains the final product specification.

This document applies to the following products:

<b>Product name</b>	<b>Type number</b>	<b>u-blox connectivity software version</b>	<b>PCN reference</b>	<b>Product status</b>
NINA-B111	NINA-B111-00B-00	1.0.0	N/A	Mass Production
	NINA-B111-01B-00	2.0.0	N/A	Mass Production
	NINA-B111-02B-00	3.0.1	N/A	Mass Production
	NINA-B111-03B-00	4.0.0	N/A	Mass Production
NINA-B112	NINA-B112-00B-00	1.0.0	N/A	Mass Production
	NINA-B112-01B-00	2.0.0	N/A	Mass Production
	NINA-B112-02B-00	3.0.1	N/A	Mass Production
	NINA-B112-03B-00	4.0.0	N/A	Mass Production

u-blox or third parties may hold intellectual property rights in the products, names, logos and designs included in this document. Copying, reproduction, modification or disclosure to third parties of this document or any part thereof is only permitted with the express written permission of u-blox.

The information contained herein is provided "as is" and u-blox assumes no liability for its use. No warranty, either express or implied, is given, including but not limited to, with respect to the accuracy, correctness, reliability and fitness for a particular purpose of the information. This document may be revised by u-blox at any time without notice. For the most recent documents, visit [www.u-blox.com](http://www.u-blox.com).

Copyright © u-blox AG.

# Contents

<b>Document Information</b> .....	<b>2</b>
<b>Contents</b> .....	<b>3</b>
<b>1 Functional description</b> .....	<b>6</b>
1.1 Overview .....	6
1.2 Product features .....	7
1.3 Block diagram .....	8
1.3.1 NINA-B111 .....	8
1.3.2 NINA-B112 .....	8
1.4 Product description .....	8
1.5 Hardware options.....	9
1.6 Software options.....	9
1.6.1 u-blox connectivity software .....	9
1.6.2 OpenCPU .....	10
1.7 Bluetooth device address .....	10
<b>2 Interfaces</b> .....	<b>11</b>
2.1 Power management .....	11
2.1.1 Module supply input (VCC) .....	11
2.1.2 Digital I/O interfaces reference voltage (VCC_IO) .....	11
2.2 RF antenna interfaces .....	11
2.2.1 2.4 GHz Bluetooth low energy (ANT) .....	11
2.2.2 Near Field Communication (NFC).....	11
2.3 System functions.....	11
2.3.1 Module power-on .....	12
2.3.2 Module power-off.....	12
2.3.3 Standby mode .....	12
2.3.4 Sleep mode.....	12
2.3.5 Module reset .....	13
2.3.6 Real Time Counter (RTC).....	13
2.4 Serial interfaces .....	13
2.4.1 Asynchronous serial interface (UART) .....	13
2.4.2 Serial peripheral interface (SPI) .....	14
2.4.3 I <sup>2</sup> C interface .....	14
2.4.4 I <sup>2</sup> S interface .....	14
2.5 GPIO .....	14
2.5.1 PWM.....	15
2.6 Analog interfaces .....	15
2.6.1 ADC.....	15
2.6.2 Comparator .....	15
2.6.3 Low power comparator .....	15
2.6.4 Analog pin options.....	16

2.7	u-blox connectivity software features .....	16
2.7.1	u-blox Serial Port Service (SPS) .....	16
2.7.2	System status signals .....	16
2.7.3	System control signals .....	16
2.7.4	UART signals .....	16
2.7.5	IO signals .....	17
2.8	Debug interfaces .....	17
2.8.1	SWD.....	17
2.8.2	Trace – Serial Wire Viewer.....	17
<b>3</b>	<b>Pin definition .....</b>	<b>18</b>
3.1	Pin assignment.....	18
3.2	Pin assignment in the u-blox connectivity software .....	20
<b>4</b>	<b>Electrical specifications .....</b>	<b>22</b>
4.1	Absolute maximum ratings .....	22
4.1.1	Maximum ESD ratings.....	22
4.2	Operating conditions.....	22
4.2.1	Operating temperature range.....	22
4.2.2	Supply/Power pins .....	23
4.2.3	Current consumption.....	23
4.2.4	RF performance .....	24
4.2.5	RESET_N pin.....	26
4.2.6	Digital pins.....	26
<b>5</b>	<b>Mechanical specifications .....</b>	<b>27</b>
5.1	NINA-B111 Mechanical specification .....	27
5.2	NINA-B112 Mechanical specifications.....	28
<b>6</b>	<b>Qualification and approvals.....</b>	<b>29</b>
6.1	Compliance with the RoHS directive.....	29
6.2	European Union regulatory compliance .....	29
6.3	Safety compliance .....	29
6.4	FCC and IC Compliance.....	29
6.4.1	IC compliance.....	29
6.4.2	Conformité aux norms d´IC.....	29
6.4.3	FCC statement.....	30
6.4.4	Labeling requirements for end product .....	30
6.4.5	FCC and IC IDs .....	31
6.5	Japan radio equipment compliance.....	31
6.6	NCC Taiwan compliance .....	31
6.6.1	Taiwan NCC Warning Statement.....	31
6.6.2	NINA-B111 labeling requirements for end product.....	32
6.6.3	NINA-B112 labeling requirements for end product.....	32
6.7	KCC South Korea compliance.....	32
6.8	Anatel Brazil compliance .....	32

6.9	Australia and New Zealand regulatory compliance .....	33
6.10	South Africa regulatory compliance .....	33
6.11	Bluetooth qualification information .....	34
<b>7</b>	<b>Antennas .....</b>	<b>35</b>
7.1	Antenna accessories .....	35
7.2	Approved antennas .....	36
<b>8</b>	<b>Product handling.....</b>	<b>39</b>
8.1	Packaging .....	39
8.1.1	Reels .....	39
8.1.2	Tapes.....	39
8.2	Moisture sensitivity levels.....	41
8.3	Reflow soldering .....	41
8.4	ESD precautions.....	41
<b>9</b>	<b>Labeling and ordering information .....</b>	<b>42</b>
9.1	Product labeling.....	42
9.2	Explanation of codes .....	42
9.3	Ordering information.....	43
<b>Appendix</b>	<b>.....</b>	<b>44</b>
<b>A</b>	<b>Glossary .....</b>	<b>44</b>
<b>Related documents</b>	<b>.....</b>	<b>45</b>
<b>Revision history</b>	<b>.....</b>	<b>45</b>
<b>Contact</b>	<b>.....</b>	<b>47</b>

# 1 Functional description

## 1.1 Overview

The NINA-B1 series modules are small stand-alone Bluetooth® low energy modules featuring Bluetooth 5 , a powerful Arm® Cortex®-M4 with FPU, and state-of-the-art power performance. The embedded low power crystal in NINA-B1 minimizes power consumption, thus extending the battery life.

The NINA-B1 is delivered with u-blox connectivity software that provides support for u-blox Bluetooth low energy Serial Port Service, GATT client and server, beacons, NFC™, and simultaneous peripheral and central roles – all configurable from a host by using AT commands.

NINA-B1 offers full flexibility for customers who prefer to add their application to run on the built-in Cortex-M4 with FPU. With 512 kB flash and 64 kB RAM, it offers the best-in-class capacity for customer applications running on top of the Bluetooth low energy stack using SDK from Nordic Semiconductor or Arm® Mbed™. Additionally, NFC and interfaces such as SPI, I<sup>2</sup>C, and I<sup>2</sup>S are available, and features like Bluetooth Mesh, AirFuel, and Apple HomeKit are also supported.

NINA-B112 comes with an internal antenna and NINA-B111 has a pin for use with an external antenna. The internal PIFA antenna is specifically designed for the small NINA-B1 form factor and provides an extensive range of more than 300 m, independent of ground plane and component placement.

The module is globally certified for use with the internal antenna or a range of external antennas. This reduces time and effort for customers integrating NINA-B1 in their designs.

## 1.2 Product features

	NINA-B11		NINA-B12	
<b>Grade</b>				
Automotive				
Professional	•		•	
Standard				
<b>Radio</b>				
Bluetooth profiles	G			
Bluetooth qualification	v5.0			
Bluetooth low energy	•		•	
Bluetooth output power EIRP [dBm] *	7		6	
Max range [meters] *	350		300	
NFC for "Touch to Pair"	•		•	
Antenna type *	p		i	
<b>Application software</b>				
u-blox connectivity software	•		•	
Open CPU for embedded customer applications		•		•
<b>Interfaces</b>				
UART	1	◆	1	◆
SPI		◆		◆
I <sup>2</sup> C		◆		◆
I <sup>2</sup> S		◆		◆
GPIO pins	7	19	7	19
AD converters (ADC)		◆		◆
<b>Features</b>				
AT command interface	•		•	
GATT server and client	•	◆	•	◆
Extended Data Mode	•		•	
Low Energy Serial Port Service	•		•	
Throughput [Mbit/s]	0.8	1.4	0.8	1.4
Maximum Bluetooth connections	7	20	7	20
FOTA		◆		◆
Mesh networking		◆		◆

G = GATT    p = Antenna pin    ◆ = Feature enabled by HW. The actual support depends on the open CPU application SW.  
 i = Internal antenna

**Table 1: NINA-B1 series main features summary**

### 1.3 Block diagram

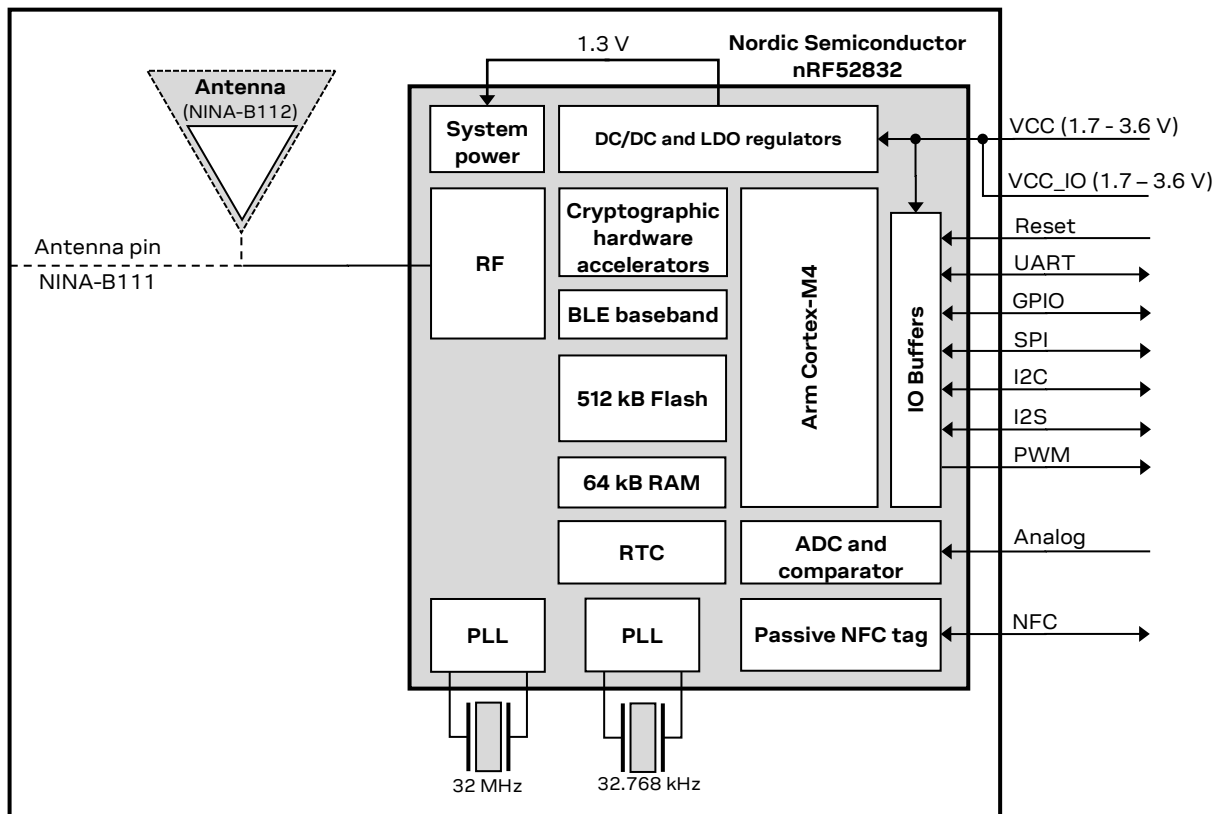

Figure 1: Block diagram of NINA-B1

#### 1.3.1 NINA-B111

The NINA-B111 modules do not use the internal antenna and thus the PCB has been trimmed to allow for a smaller module (10.0 x 10.6 mm). Instead of an internal antenna, the RF signal is available at a module pin for routing to an external antenna or antenna connector.

#### 1.3.2 NINA-B112

The NINA-B112 modules use an integrated antenna mounted on the PCB (10.0 x 14.0 mm). The RF signal pin is not connected to any signal path.

### 1.4 Product description

Item	NINA-B111	NINA-B112
Bluetooth version	5.0	5.0
Band support	2.4 GHz, 40 channels	2.4 GHz, 40 channels
Typical conducted output power	+4 dBm	+4 dBm
Radiated output power (EIRP)	+7 dBm (with approved antennas)	+6 dBm
Sensitivity (conducted)	-95 dBm	-95 dBm
Data rates	1 and 2 Mbps GFSK	1 and 2 Mbps GFSK
Module size	10.0x10.6 mm	10.0x14.0 mm

Table 2: NINA-B1 series characteristics summary



## 1.5 Hardware options

Except for the different PCB sizes and antenna solutions, the NINA-B1 series modules use an identical hardware configuration. An on board 32.768 KHz crystal is always included and an integrated DC/DC converter for higher efficiency under heavy load situations (see section 2.1.1 for more information).

## 1.6 Software options

The integrated application processor of the NINA-B1 module is an Arm Cortex-M4 with FPU that has 512 kB flash memory and 64 kB RAM. The software structure of any program running on the module can be broken down into the following components:

- Radio stack
- Bootloader (optional)
- Application

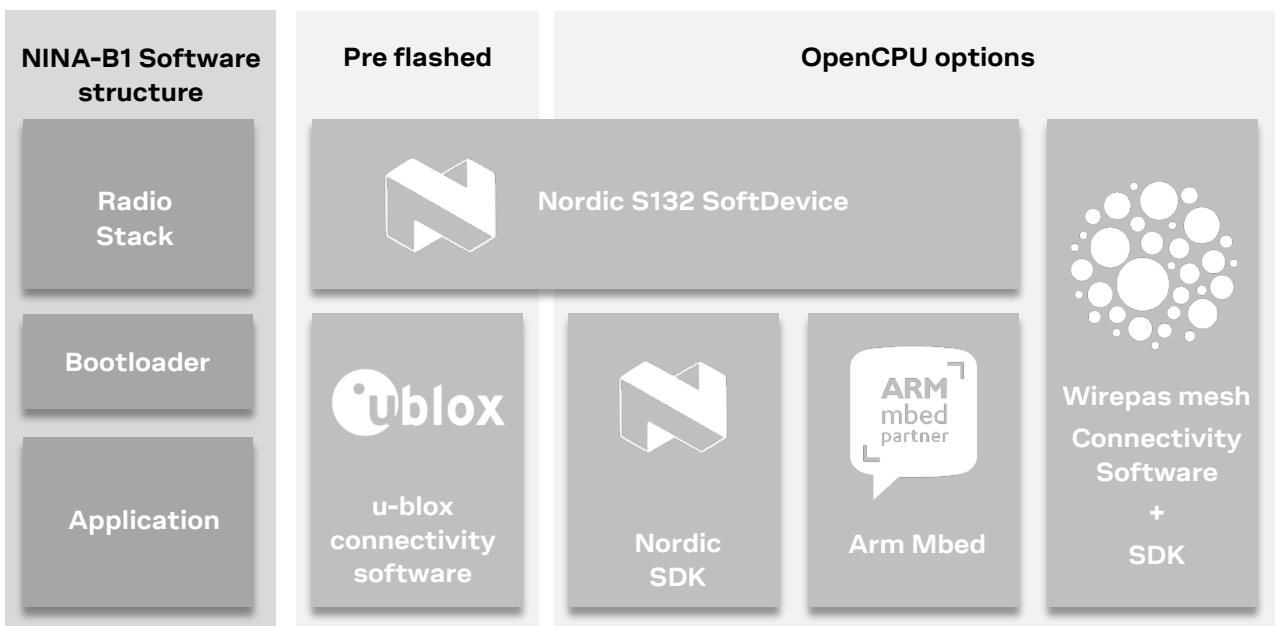

Figure 2: NINA-B1 software structure and available software options

More information on each option can be found in the NINA-B1 Series System Integration Manual [1].

### 1.6.1 u-blox connectivity software

The NINA-B1 module is preflashed with u-blox connectivity software.

The u-blox connectivity software enables the use of the u-blox Low Energy Serial Port Service, controlled by AT-commands over the UART interface. You can configure NINA-B1 modules through u-blox s-center software using the AT commands. The s-center evaluation software can be downloaded from the u-blox website and is available free of charge.

More information on the features and capabilities of the u-blox Low Energy Serial Port Service and how to use this can be found in the NINA-B1 Getting started guide [5] and the u-blox Short Range AT commands manual [3].

## 1.6.2 OpenCPU

If you need a custom application embedded in the NINA-B1 module, u-blox recommends using the following development approaches to speed up the process:

### 1.6.2.1 Nordic SDK

The Nordic nRF5 SDK provides a rich and well tested software development environment for nRF52-based devices. It includes a broad selection of drivers, libraries, and example applications. It also includes other radio stacks, however note that the NINA-B1 series modules are only certified for use with the S132 Bluetooth Low Energy SoftDevice. A customer wishing to use a proprietary 2.4 GHz radio protocol should contact u-blox support.

### 1.6.2.2 Arm Mbed OS

Arm Mbed OS is an open source embedded operating system designed specifically for the "things" in the Internet of Things. It includes all features to develop a connected product, including security, connectivity, an RTOS, and drivers for sensors and I/O devices. The u-blox NINA-B1 series fully supports Mbed OS 5.

### 1.6.2.3 Wirepas connectivity software

The NINA-B1 series modules can also be used together with the Wirepas software stack. This will enable the NINA-B1 module to be used in a large-scale mesh environment.

The Wirepas connectivity software is a third party licensed software from Wirepas.

For more information about the Wirepas connectivity software, contact the u-blox support for your area as listed in the Contact section or Wirepas directly.

## 1.7 Bluetooth device address

Each NINA-B1 module is preprogrammed with a unique 48-bit Bluetooth device address. If the memory of the module is corrupted or otherwise lost, the address can be recovered from the data matrix barcode printed on the module label. The NINA-B1 Series System Integration Manual [1] contains detailed information on how to recover and/or reprogram the Bluetooth device address if it is lost.

## 2 Interfaces

### 2.1 Power management

#### 2.1.1 Module supply input (VCC)

The NINA-B1 series uses integrated step-down converters to transform the supply voltage presented at the **VCC** pin into a stable system voltage. Due to this, the NINA-B1 modules are compatible for use in battery powered designs without the use of an additional voltage converter. You can choose one of the following two on-board voltage converter options:

- A low-dropout (LDO) converter
- A DC/DC buck converter

Under normal use, the module will automatically switch between these options depending on the current consumption of the module. Under high loads such as when the radio is active, the DC/DC converter will be more efficient, while the LDO will be more efficient in power saving modes.

#### 2.1.2 Digital I/O interfaces reference voltage (VCC\_IO)

All modules in the u-blox NINA series provide an additional voltage supply input for setting the I/O voltage level. On the NINA-B1 series modules, the I/O voltage level is the same as the supply voltage and **VCC\_IO** is internally connected to the supply input. Therefore only a single supply voltage is needed for NINA-B1, which makes it ideal for battery powered designs.

 This may not be the case for modules in the NINA series that will be released in the future. A design that should be pin compatible with other NINA-series modules should keep the VCC and VCC\_IO supply rails separate.

## 2.2 RF antenna interfaces

### 2.2.1 2.4 GHz Bluetooth low energy (ANT)

The two NINA-B1 model versions have their own 2.4 GHz antenna solutions respectively:

- The NINA-B111 modules provide an antenna pin (**ANT**) with a nominal characteristic impedance of 50  $\Omega$ . This pin can be connected to an on-board antenna or antenna connector using a controlled impedance trace. See the NINA-B1 Series System Integration Manual [1] for more information.
- The NINA-B112 modules use an integrated antenna solution; no additional components are required. The **ANT** pin is internally disconnected on these models.

### 2.2.2 Near Field Communication (NFC)

The NINA-B1 series modules include a Near Field Communication interface, capable of operating as a 13.56 MHz NFC tag at a bit rate of 106 kbps. As an NFC tag, data can be read from or written to the NINA-B1 modules using an NFC reader; however the NINA-B1 modules are not capable of reading other tags or initiating NFC communications. Two pins are available for connecting to an external NFC antenna: **NFC1** and **NFC2**. See the NINA-B1 Series System Integration Manual [1] for more information and NFC antenna design considerations.

## 2.3 System functions

The NINA-B1 series modules are power efficient devices capable of operating in different power saving modes and configurations. Different sections of the module can be powered off when not needed and complex wake up events can be generated from different external and internal inputs. The radio part of the module operates independently from the CPU.

The two main power saving modes are:

- Standby mode
- Sleep mode

Depending on the application, the module should spend most of its time in sleep mode to conserve battery life.

### 2.3.1 Module power-on

NINA-B1 modules can be switched on in one of the following ways and this will cause the module to reboot:

- Rising edge on the VCC pin to a valid supply voltage
- Issuing a reset of the module

A wake up event from sleep mode to active mode can be issued by:

- Changing the state of any digital I/O pin, may be enabled /disabled for each pin.

If waking up from standby mode, an event can also be issued by:

- The on-board Real Time Counter (RTC)
- A programmable digital or analog sensor event. For example, rising voltage level on an analog comparator pin

### 2.3.2 Module power-off

There is no dedicated pin to power off the NINA-B1 modules. You can configure any GPIO pin to enter or exit the sleep mode (see section 2.3.4), which essentially powers down the module.

An under-voltage (brown-out) shutdown occurs on NINA-B1 modules when the **VCC** supply drops below the operating range minimum limit. If this occurs, it is not possible to store the current parameter settings in the module's non-volatile memory. An over-temperature and under-temperature shutdown can be enabled on NINA-B1 modules, and is initiated if the temperature measured within the module is outside operating conditions. The temperature is measured by an integrated temperature sensor in the radio chip. For more details see the NINA-B1 Series System Integration Manual [1].

### 2.3.3 Standby mode

Standby mode is one of the power saving modes in NINA-B1 modules that essentially powers down the module but keeps the system RAM intact and allows for a few low power digital interfaces (including SPI) and analog functions to run continuously. It also allows for complex, autonomous power-up events including periodic RTC events and radio events.

The following events can be used to bring the module out of the standby mode:

- External wake-up events
- Internal wake-up events from RTC, radio, NFC and so on
- Analog or digital sensor event (programmable voltage level or edge detection)

During standby mode, the module is clocked at 32 kHz, which is generated by an internal 32 kHz crystal oscillator.

### 2.3.4 Sleep mode

Sleep mode is the deepest power saving mode of NINA-B1 modules. During sleep mode, all functionality is stopped to ensure minimum power consumption. The module needs an external event in order to wake up from sleep mode.

The following events can be used to wake up the module out of the sleep mode:

- External event on a digital pin
- External event on a low power comparator pin
- Detection of NFC field

When using the u-blox connectivity software, the module can be manually switched on or off with proper storage of current settings using the UART **DSR** pin.

The module can be programmed to latch the digital values present at its GPIO pins during sleep. The module will keep the values latched, and a change of state on any of these pins will trigger a wake up to active mode.

The module will always reboot after waking up from the sleep mode; however different sections of the RAM can be configured to remain intact during and after going into the sleep mode.

### 2.3.5 Module reset

NINA-B1 modules can be reset in one of the following ways:

- Low level on the RESET\_N input pin, normally high with internal pull-up. This causes an “external” or “hardware” reset of the module. The current parameter settings are not saved in the module’s non-volatile memory and a proper network detach is not performed.
- Using the AT+CPWROFF command. This causes an “internal” or “software” reset of the module. The current parameter settings are saved in the module’s non-volatile memory and a proper network detach is performed.

### 2.3.6 Real Time Counter (RTC)

A key system feature available on the module is the Real Time Counter. This counter can generate multiple interrupts and events to the CPU and radio as well as internal and external hardware blocks. These events can be precisely timed ranging from microseconds up to hours, and allows for periodic BLE advertising events etc., without involving the main CPU. The RTC can be operated in power-on and standby modes.

## 2.4 Serial interfaces

NINA-B1 modules provide the following serial communication interfaces:

- 1x UART interface: 4-wire unbalanced asynchronous serial interface used for AT commands interface, data communication and u-blox connectivity software upgrades using the FOAT feature.
- 3x SPI interfaces: Up to three serial peripheral interfaces can be used simultaneously.
- 2x I2C interfaces: Inter-Integrated Circuit (I2C) interface for communication with digital sensors.

 All digital interface pins on the module are shared between the digital and analog interfaces and GPIOs. Any function can be assigned to any pin that is not already occupied.

### 2.4.1 Asynchronous serial interface (UART)

The UART interface supports hardware flow control and baud-rates up to 1 Mbps. Other characteristics of the UART interface are listed below:

- Data lines (**RXD** as input, **TXD** as output) and hardware flow control lines (**CTS** as input, **RTS** as output) are provided.
- Hardware flow control or no flow control (default) is supported.
- Power saving indication available on the hardware flow control output (**CTS** line): The line is driven to the OFF state when the module is not ready to accept data signals.
- Programmable baud-rate generator allows most industry standard rates, as well as non-standard rates up to 1 Mbps.

- Frame format configuration:
  - 8 data bits
  - Even or no-parity bit
  - 1 stop bit

Default frame configuration is 8N1, meaning eight (8) data bits, no (N) parity bit, and one (1) stop bit.

## 2.4.2 Serial peripheral interface (SPI)

NINA-B1 supports up to 3 Serial Peripheral Interfaces that can operate in both master and slave mode with a maximum serial clock frequency of 8 MHz in both master and slave modes. The SPI interfaces use 4 signals: **SCLK**, **MOSI**, **MISO** and **CS**. When using the SPI interface in master mode, it is possible to use GPIOs as additional Chip Select (CS) signals to allow addressing of multiple slaves.

## 2.4.3 I<sup>2</sup>C interface

The Inter-Integrated Circuit interfaces can be used to transfer or receive data on a 2-wire bus network. The NINA-B1 modules can operate as both master and slave on the I2C bus using both standard (100 kbps) and fast (400 kbps) transmission speeds. The interface uses the **SCL** signal to clock instructions and data on the **SDL** signal.

## 2.4.4 I<sup>2</sup>S interface

The Inter-IC Sound (I2S) interface can be used to transfer audio sample streams between NINA-B1 and external audio devices such as codecs, DACs, and ADCs. It supports original I2S and left or right-aligned interface formats in both master and slave mode. It uses up to 5 signals: Master clock (**MCK**), Left right clock or Word clock (**LRCK**), Serial clock (**SCK**), Serial data in (**SDIN**) and Serial data out (**SDOUT**). The Master side of the interface always provides the **LRCK** and **SCK** clock signals, but as an addition NINA-B1 can supply a **MCK** clock signal in both master and slave mode to provide to external systems that cannot generate their own clock signal. The two data signals - **SDIN** and **SDOUT** allow for simultaneous bi-directional audio streaming. The interface supports 8, 16 and 24-bit sample widths with up to 48 kHz sample rate.

## 2.5 GPIO

The NINA-B1 modules are versatile concerning pin-out. If un-configured, there will be 19 GPIO pins in total and no analog or digital interfaces. All digital interfaces or functions must then be allocated to a GPIO pin before use. 8 out of the 19 GPIO pins are analog enabled thus they can have an analog function allocated to them. In addition to the serial interfaces, Table 3 shows the number of digital and analog functions that can be assigned to a GPIO pin.

Function	Description	Default NINA pin	Configurable GPIOs
General purpose input	Digital input with configurable edge detection and interrupt generation		Any
General purpose output	Digital output with configurable drive strength, pull-up, pull-down, open-source, open-drain and/or slew rate		Any
Pin disabled	Pin is disconnected from input buffers and output drivers.	All*	Any
Timer/ counter	High precision time measurement between two pulses/ Pulse counting with interrupt/event generation		Any
Interrupt/ Event trigger	Interrupt/event trigger to the software application/ Wake up event		Any
ADC input	8/10/12-bit analog to digital converter		Any analog
Analog comparator input	Compare two voltages, capable of generating wake-up events and interrupts		Any analog

Function	Description	Default NINA pin	Configurable GPIOs
PWM output	Output complex pulse width modulation waveforms		Any
Connection status indication	Indicates if a BLE connection is maintained	BLUE**	Any

\* = If left unconfigured

\*\* = If using the u-blox connectivity software

**Table 3: GPIO custom functions configuration**

## 2.5.1 PWM

The NINA-B1 modules provide up to 12 independent PWM channels that can be used to generate complex waveforms. These waveforms can be used to control motors, dim LEDs and as audio signals, if connected to speakers. Duty-cycle sequences may be stored in RAM to be chained and looped into complex sequences without CPU intervention. Each channel uses a single GPIO pin as output.

## 2.6 Analog interfaces

8 out of the 19 digital GPIOs can be multiplexed to analog functions. The following analog functions are available for use:

- 1x 8-channel ADC
- 1x Analog comparator\*
- 1x Low-power analog comparator\*

\*Only one of the comparators can be used simultaneously.

### 2.6.1 ADC

The Analog to Digital Converter (ADC) can sample up to 200 kHz using different inputs as sample triggers. It supports 8/10/12-bit resolution. Any of the 8 analog inputs can be used both as single-ended inputs and as differential pairs for measuring the voltage across them. The ADC supports full 0 V to VCC input range.

### 2.6.2 Comparator

The comparator compares voltages from any analog pin with different references as shown in Table 4. It supports full 0 V to VCC input range and can generate different software events to the rest of the system.

### 2.6.3 Low power comparator

The low-power comparator operates in the same way as the normal comparator, with some reduced functionality. It can be used during sleep mode as a wake up source.

## 2.6.4 Analog pin options

Table 4 shows the supported connections of the analog functions.

 An analog pin may not be simultaneously connected to multiple functions.

Analog function	Can be connected to
ADC single-ended input	Any analog pin or VCC
ADC differential input	Any analog pin or VCC pair
Comparator IN+	Any analog pin
Comparator IN-	Pin 24 or 25, VCC, 1.2 V, 1.8 V, 2.4 V
Low-power comparator IN+	Any analog pin
Low-power comparator IN-	Pin 24 or 25, 1/16 to 15/16 VCC in steps of 1/16 VCC

**Table 4: Possible uses of analog pin**

## 2.7 u-blox connectivity software features

 This section describes the available features when using the u-blox connectivity software. For additional information, see the u-blox Short Range AT Commands Manual [3] and NINA-B1 Getting Started [5].

### 2.7.1 u-blox Serial Port Service (SPS)

The serial port service feature enables serial port emulation over Bluetooth low energy.

### 2.7.2 System status signals

The RED, GREEN and BLUE pins are used to signal the system status according to Table 5. They are active low and are intended to be routed to an RGB LED.

Mode	Status	RGB LED Color	RED	GREEN	BLUE
Data\Extended Data mode (EDM)	IDLE	Green	HIGH	LOW	HIGH
Command mode	IDLE	Orange	LOW	LOW	HIGH
EDM/Data mode, Command mode	CONNECTING	Purple	LOW	HIGH	LOW
EDM/Data mode, Command mode	CONNECTED*	Blue	HIGH	HIGH	LOW

\* = LED flashes on data activity

**Table 5: System status indication**

 The CONNECTING and CONNECTED statuses indicate u-blox SPS connections.

### 2.7.3 System control signals

The following input signals are used to control the system:

- **RESET\_N** is used to reset the system. See section 2.3.5 for detailed information.
- If **SWITCH\_2** is driven low during start up, the UART serial settings are restored to their default values.
- **SWITCH\_2** can be used to open a Bluetooth LE connection with a peripheral device.
- If both **SWITCH\_1** and **SWITCH\_2** are driven low during start up, the system will enter the bootloader mode.
- If both **SWITCH\_1** and **SWITCH\_2** are driven low during start up and held low for 10 seconds, the system will exit the bootloader mode and restore all settings to their factory default.

### 2.7.4 UART signals

In addition to the normal **RXD**, **TXD**, **CTS**, and **RTS** signals, the u-blox connectivity software adds the **DSR** and **DTR** pins to the UART interface. Note that they are not used as originally intended, but to control the state of the NINA module. For example, depending on the current configuration:



The **DSR** pin can be used to:

- Enter command mode
  - Disconnect and/or toggle connectable status
  - Enable/disable the rest of the UART interface
- Enter/wake up from sleep mode

The **DTR** pin can be used to indicate:

- The system mode
- If the SPS peers are connected
- If a Bluetooth LE bonded device is connected
- A Bluetooth LE GAP connection

 See the u-blox Short Range AT Commands Manual [3] and NINA-B1 Getting Started [5] for more information.

## 2.7.5 IO signals

When using the u-blox connectivity software, 7 module pins can be used for manual, digital read/write operations. These pins can be configured as outputs or inputs with or without pull-up/pull-down, using AT commands. For more information, see the u-blox Short Range AT Commands Manual [3].

 In this data sheet, these signals are defined as IO signals to distinguish from the GPIO signals described in section 2.5. The IO signals are used with u-blox connectivity software only and controlled using AT commands; the GPIO signals, being a hardware functionality, can be used only by writing a custom software application.

## 2.8 Debug interfaces

### 2.8.1 SWD

The NINA-B1 series modules provide an SWD interface for flashing and debugging. The SWD interface consists of two pins: **SWDCLK** and **SWDIO**.

### 2.8.2 Trace – Serial Wire Viewer

A serial trace option will also be available as an additional pin: **SWO**. The Serial Wire Output is used to:

- Support printf style debugging
- Trace OS and application events
- Emit diagnostic system information

A debugger that supports Serial Wire Viewer (SWV) is required. The trace function can be used only when developing a custom application.

## 3 Pin definition

### 3.1 Pin assignment

The pin-out described in Figure 3 below is an example pin-out that shows the module in an unconfigured state. Alternatively, if you use the u-blox connectivity software, refer to the pin-out in section 3.2.

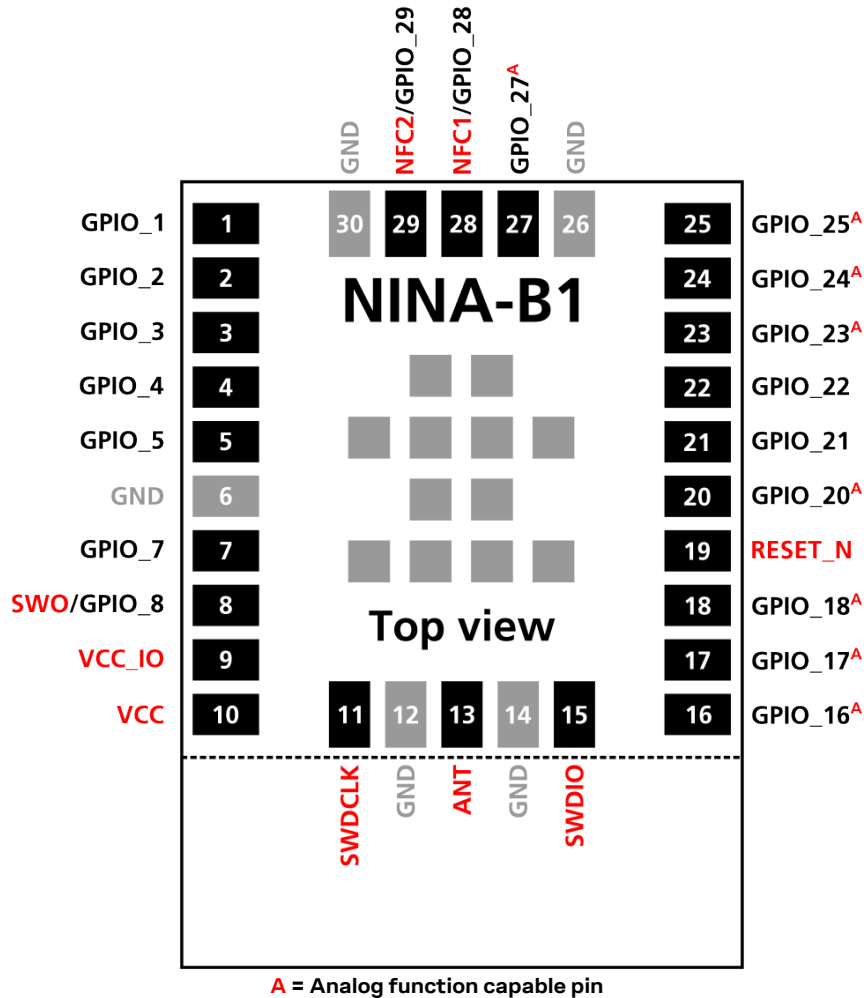





Figure 3: NINA-B1 series pin assignment (top view)

The grey pins in the center of the modules are GND pins. The outline of NINA-B111 ends at the dotted line as shown in Figure 3, where the antenna area of NINA-B112 begins.

-  All digital or analog functions described in this data sheet may be freely assigned to any GPIO pin. Analog functions are limited to analog capable pins. Signals marked **red** in Figure 3 are not freely assignable but locked to a specific pin.
-  GPIO pins 16, 17, 18 and 20 are connected to pins located close to the radio part of the RF chip. It is recommended to avoid using these pins for high speed digital interfaces or sinking/sourcing large currents through them. Doing so may affect RF performance.
-  Do not apply an NFC field to the NFC pins when they are configured as GPIOs as it can cause permanent damage to the module. When driving different logic levels on these pins in GPIO mode, a small current leakage will occur. Ensure that they are set to the same logic level before entering into any power saving modes. See section 4.2.6 for more information.

No.	Name	I/O	Description	nRF52 pin	Remarks
1	GPIO_1	I/O	General purpose I/O	P0.08	
2	GPIO_2	I/O	General purpose I/O	P0.11	
3	GPIO_3	I/O	General purpose I/O	P0.12	
4	GPIO_4	I/O	General purpose I/O	P0.13	
5	GPIO_5	I/O	General purpose I/O	P0.14	
6	GND	-	Ground		
7	GPIO_7	I/O	General purpose I/O	P0.16	
8	SWO/GPIO_8	I/O	Serial Wire debug trace data output	P0.18	May be used as a GPIO
9	VCC_IO	I	Module I/O level voltage input		Must be connected to VCC on NINA-B1
10	VCC	I	Module supply voltage input		1.7-3.6 V range
11	SWDCLK	I	Serial Wire Debug port clock signal		
12	GND	-	Ground		
13	ANT	I/O	Tx/Rx antenna interface		50 Ω nominal characteristic impedance, only used with NINA-B111 modules
14	GND	-	Ground		
15	SWDIO	I/O	Serial Wire Debug port data signal		
16	GPIO_16	I/O	Analog function enabled GPIO	P0.28	Pin is analog capable, use as low drive, low frequency GPIO only
17	GPIO_17	I/O	Analog function enabled GPIO	P0.29	Pin is analog capable, use as low drive, low frequency GPIO only
18	GPIO_18	I/O	Analog function enabled GPIO	P0.30	Pin is analog capable, use as low drive, low frequency GPIO only
19	RESET_N	I/O	System reset input	P0.21	Active low
20	GPIO_20	I/O	Analog function enabled GPIO	P0.31	Pin is analog capable, use as low drive, low frequency GPIO only
21	GPIO_21	I/O	General purpose I/O	P0.07	
22	GPIO_22	I/O	General purpose I/O	P0.06	
23	GPIO_23	I/O	Analog function enabled GPIO	P0.05	Pin is analog capable
24	GPIO_24	I/O	Analog function enabled GPIO	P0.02	Pin is analog capable
25	GPIO_25	I/O	Analog function enabled GPIO	P0.03	Pin is analog capable
26	GND	-	Ground		
27	GPIO_27	I/O	Analog function enabled GPIO	P0.04	Pin is analog capable
28	NFC1/GPIO_28	I/O	NFC pin 1 (default)	P0.09	May be used as a GPIO
29	NFC2/GPIO_29	I/O	NFC pin 2 (default)	P0.10	May be used as a GPIO
30	GND	-	Ground		
	EGP	-	Exposed Ground Pins		The exposed pins in the center of the module should be connected to GND

**Table 6: NINA-B1 series pin-out**

### 3.2 Pin assignment in the u-blox connectivity software

The pin-out as shown in Figure 4 describes the pin configuration used in the u-blox connectivity software.

Figure 4 and Table 7 reflect the latest u-blox connectivity software version only.

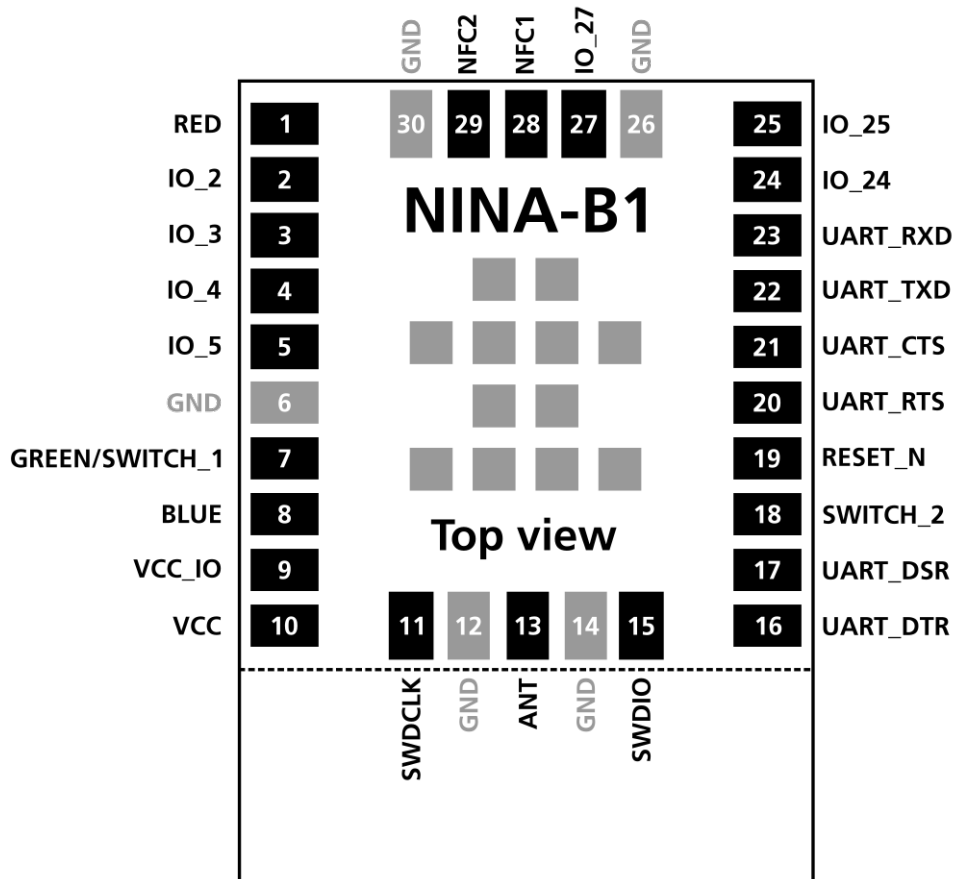

Figure 4: NINA-B1 series pin assignment (top view) while using the u-blox connectivity software

The grey pins in the center of the modules are GND pins. The outline of NINA-B111 ends at the dotted line as shown in Figure 4, where the antenna area of NINA-B112 begins.

It is required to follow this pin layout when using the u-blox connectivity software. No additional interfaces can be added.

No.	Name	I/O	Description	Remarks
1	RED	O	RED system status signal	Active low, should be routed to an RGB LED
2	IO_2	I/O	u-blox connectivity software IO pin	Can be used for manual digital I/O
3	IO_3	I/O	u-blox connectivity software IO pin	Can be used for manual digital I/O
4	IO_4	I/O	u-blox connectivity software IO pin	Can be used for manual digital I/O
5	IO_5	I/O	u-blox connectivity software IO pin	Can be used for manual digital I/O
6	GND	-	Ground	
7	GREEN/SWITCH_1	I/O	This signal is multiplexed: GREEN: System status signal. SWITCH_1: Multiple functions	Active low. GREEN: Should be routed to an RGB LED. SWITCH_1: See section 2.7.3 for more information.
8	BLUE	O	BLUE system status signal	Active low, should be routed to an RGB LED
9	VCC_IO	I	Module I/O level voltage input	Must be connected to VCC on NINA-B1
10	VCC	I	Module supply voltage input	1.7-3.6 V range
11	SWDCLK	I	Serial Wire Debug port clock signal	
12	GND	-	Ground	
13	ANT	I/O	Tx/Rx antenna interface	50 $\Omega$ nominal characteristic impedance, only used with NINA-B111 modules
14	GND	-	Ground	
15	SWDIO	I/O	Serial Wire Debug port data signal	
16	UART_DTR	O	UART data terminal ready signal	Used to indicate system status
17	UART_DSR	I	UART data set ready signal	Used to change system modes
18	SWITCH_2	I	Multiple functions	Active low, see section 2.7.3 for more information.
19	RESET_N	I	External system reset input	Active low
20	UART_RTS	O	UART request to send control signal	Used only when hardware flow control is enabled
21	UART_CTS	I	UART clear to send control signal	Used only when hardware flow control is enabled
22	UART_TXD	O	UART data output	
23	UART_RXD	I	UART data input	
24	IO_24	I/O	u-blox connectivity software IO pin	Can be used for manual digital I/O
25	IO_25	I/O	u-blox connectivity software IO pin	Can be used for manual digital I/O
26	GND	-	Ground	
27	IO_27	I/O	u-blox connectivity software IO pin	Can be used for manual digital I/O
28	NFC1	I/O	NFC pin 1	
29	NFC2	I/O	NFC pin 2	
30	GND	-	Ground	
	EGP	-	Exposed Ground Pad	The exposed pads in the center of the module should be connected to GND

**Table 7: NINA-B1 series and u-blox connectivity software pin-out**

## 4 Electrical specifications

Stressing the device above one or more of the ratings listed in the Absolute maximum rating section may cause permanent damage. These are stress ratings only. Operating the module at these or at any conditions other than those specified in the Operating conditions section of this document should be avoided. Exposure to absolute maximum rating conditions for extended periods may affect device reliability.

Operating condition ranges define those limits within which the functionality of the device is guaranteed. Where application information is given, it is advisory only and does not form part of the specification.

### 4.1 Absolute maximum ratings

Symbol	Description	Condition	Min	Max	Unit
VCC	Module supply voltage	Input DC voltage at VCC pin	-0.3	3.9	V
V_DIO	Digital pin voltage	Input DC voltage at any digital I/O pin	-0.3	3.9	V
P_ANT	Maximum power at receiver	Input RF power at antenna pin		+10	dBm

**Table 8: Absolute maximum ratings**

The product is not protected against overvoltage or reversed voltages. If necessary, voltage spikes exceeding the power supply voltage specification, given in table above, must be limited to values within the specified boundaries by using appropriate protection devices.

#### 4.1.1 Maximum ESD ratings

Parameter	Min	Typical	Max	Unit	Remarks
ESD sensitivity for all pins except ANT pin			4	kV	Human body model according to JEDEC JS001
			750	V	Charged device model according to JESD22-C101
ESD indirect contact discharge			±8	kV	According to EN 301 489-1

**Table 9: Maximum ESD ratings**

NINA-B1 series modules are Electrostatic Sensitive Devices and require special precautions while handling. See section 8.4 for ESD handling instructions.

### 4.2 Operating conditions

Unless otherwise specified, all operating condition specifications are at an ambient temperature of 25°C and a supply voltage of 3.0 V.

Operation beyond the specified operating conditions is not recommended and extended exposure beyond them may affect device reliability.

#### 4.2.1 Operating temperature range

Parameter	Min	Max	Unit
Storage temperature	-40	+85	°C
Operating temperature	-40	+85	°C

**Table 10: Temperature range**

## 4.2.2 Supply/Power pins

Symbol	Parameter	Min	Typ	Max	Unit
VCC	Input supply voltage	1.7	3.0	3.6	V
t_RVCC	Supply voltage rise time			60	ms
VCC_ripple	VCC input noise peak to peak, 10 - 100 KHz			100	mV
	VCC input noise peak to peak, 100 KHz - 1 MHz			50	mV
	VCC input noise peak to peak, 1 - 3 MHz			25	mV
VCC_IO	I/O reference voltage		VCC		V

**Table 11: Input characteristics of voltage supply pins**

## 4.2.3 Current consumption

Table 12 shows the typical current consumption of a NINA-B1 module, independent of the software used.

Mode	Condition	Typical	Peak
Sleep	No clocks running, no RAM data retention	300 nA	
Sleep	No clocks running, 64 kB RAM data retention	620 nA	
Standby	RTC and 64 kB RAM data retention. System running on 32.768 kHz clock from crystal.	2.2 $\mu$ A	
Active	CPU running benchmarking tests @ 64 MHz clock speed, all interfaces idle	3.7 mA	
Active	Radio RX only	5.4 mA	
Active	Radio TX only, +0dBm output power	5.3 mA	

**Table 12: Module VCC current consumption**

Table 13 shows the current consumption during some typical use cases when using the u-blox connectivity software:

Mode	Condition	3.3 V VCC		1.8 V VCC	
		Average	Peak	Average	Peak
Active	Advertising 1s periods with +4 dBm output power and 31 bytes payload, CPU and UART interface is running	1.8 mA	12 mA	2.5 mA	20 mA
Standby	Advertising 1s periods with +4 dBm output power and 31 bytes payload	26 $\mu$ A	9.3 mA	34 $\mu$ A	16 mA
Standby	One advertisement event (4.7 ms), +4 dBm output power and 31 bytes payload	3.4 mA	9.3 mA	5.3 mA	16 mA
Active	Connected as peripheral, connection events 30 ms periods, +4 dBm output power and 0 bytes payload, CPU and UART interface is running	1.8 mA	12 mA	2.6 mA	21 mA
Standby	Connected as peripheral, connection events 30 ms periods, +4 dBm output power and 0 bytes payload	140 $\mu$ A	9.2 mA	190 $\mu$ A	16 mA
Sleep	UART DSR pin is used to enter sleep mode. No RAM retention	300 nA	2.6 mA	300 nA	2.6 mA

**Table 13: Current consumption during typical use cases**

### 4.2.4 RF performance

Parameter	Test condition	Min	Typ	Max	Unit
Receiver input sensitivity	Conducted at 25 °C		-95		dBm
Output power	Conducted at 25 °C		+4		dBm

Table 14: RF performance

#### 4.2.4.1 NINA-B112 radiation patterns

The below radiation patterns show the relative output power of an EVB-NINA-B112 transmitting at 0 dBm output power. Both horizontal and vertical antenna polarizations were used. The NINA-B112 module was rotated 360° around the azimuth axis while being kept at 0°, 90° and 180° elevation as shown in Figure 5.

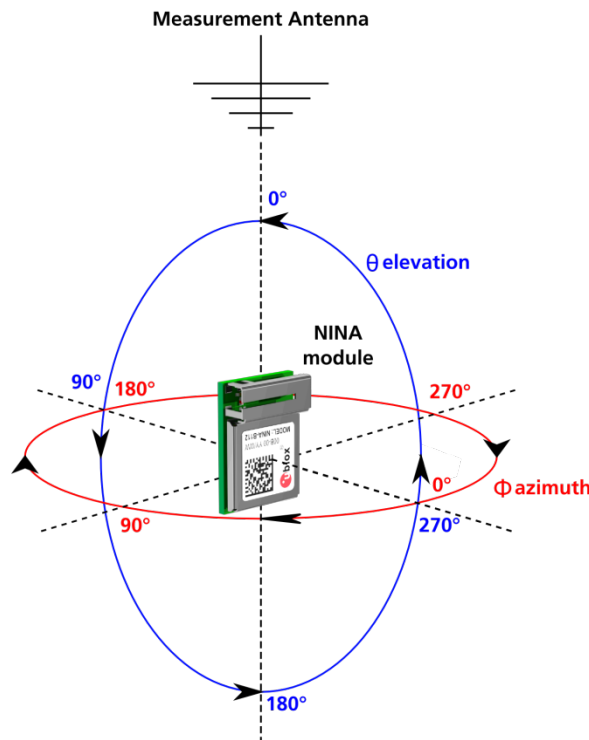

Figure 5: Azimuth and elevation rotation axes relative to the measurement antenna



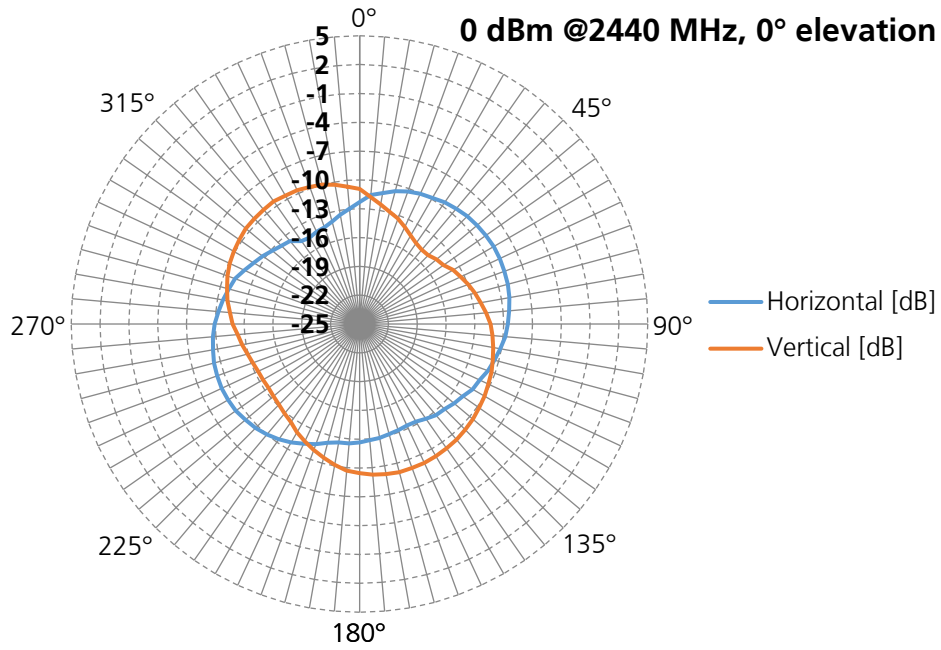

Figure 6: Radiation pattern of NINA-B112 kept at 0° elevation

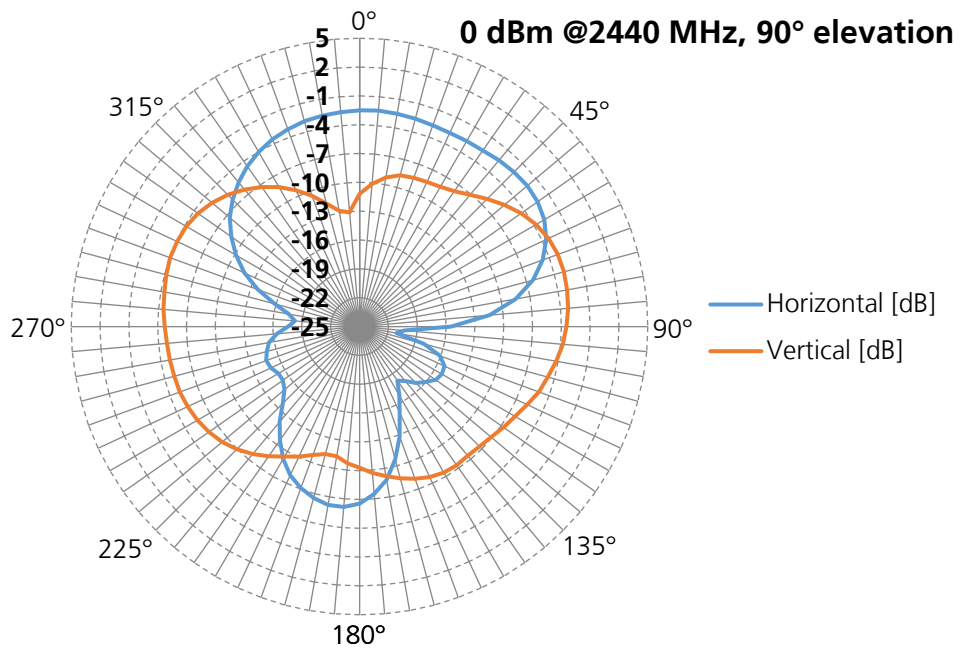

Figure 7: Radiation pattern of NINA-B112 kept at 90° elevation

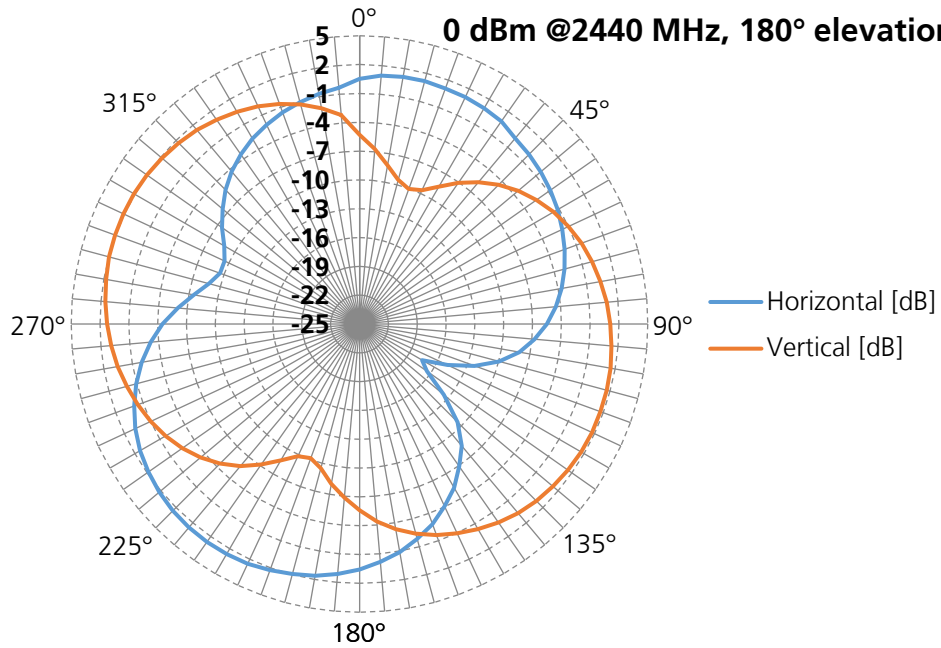

Figure 8: Radiation pattern of NINA-B112 kept at 180° elevation

### 4.2.5 RESET\_N pin

Pin name	Parameter	Min	Typ	Max	Unit	Remarks
RESET_N	Low-level input	0		0.3*VCC	V	
	Internal pull-up resistance		13		kΩ	
	RESET duration			55	ms	Time taken to release a pin reset.

Table 15: RESET\_N pin characteristics

### 4.2.6 Digital pins

Pin name	Parameter	Min	Typ	Max	Unit	Remarks
Any digital pin	Input characteristic: Low-level input	0		0.3*VCC	V	
	Input characteristic: high-level input	0.7*VCC		VCC	V	
	Output characteristic: Low-level output	0		0.4	V	Normal drive strength
		0		0.4	V	High drive strength
	Output characteristic: High-level output	VCC-0.4		VCC	V	Normal drive strength
	VCC-0.4		VCC	V	High drive strength	
GPIO_28, GPIO_29	Leakage current		2	10	μA	When driven to different logic levels

Table 16: Digital pin characteristics

## 5 Mechanical specifications

### 5.1 NINA-B111 Mechanical specification

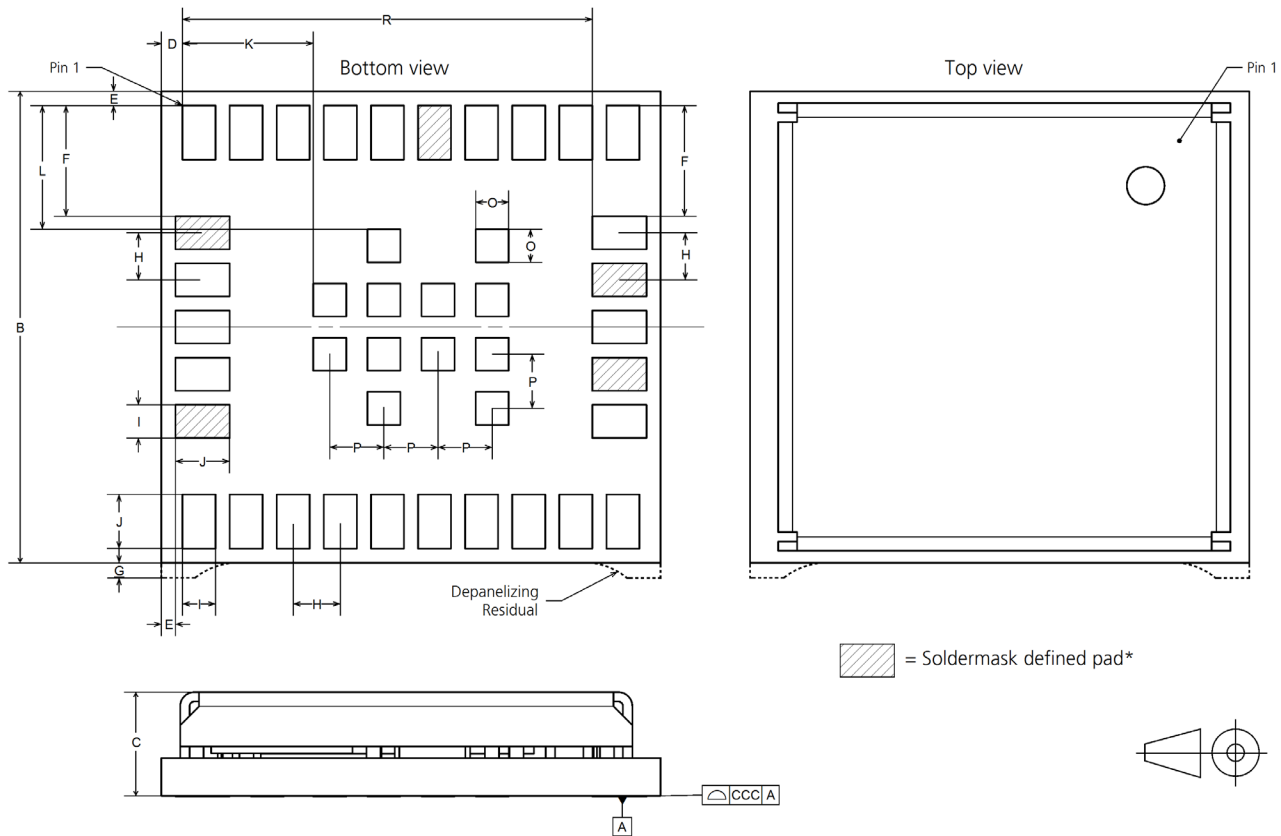

Figure 9: NINA-B111 mechanical outline

Parameter	Description	Typical		Tolerance	
A	Module PCB Length [mm]	10.6	(417 mil)	+0.20/-0.10	(+7.9/-3.9 mil)
B	Module PCB Width [mm]	10.0	(394 mil)	+0.20/-0.10	(+7.9/-3.9 mil)
C	Module Thickness [mm]	2.2	(87 mil)	+0.40/-0.20	(+16/-7.9 mil)
ccc	Seating Plane Coplanarity [mm]	0.10	(3.9 mil)	+0.02/-0.10	(+0.8/-3.9 mil)
D	Horizontal Edge to Lateral Pin No 1 Edge [mm]	0.45	(18 mil)	+0.10/-0.10	(+3.9/-3.9 mil)
E	Vertical and Horizontal Edge to Lateral Pin No 1 Edge	0.30	(12 mil)	+0.10/-0.10	(+3.9/-3.9 mil)
F	Vertical Pin No1 Edge to Lateral Pin Edge [mm]	2.35	(92.5 mil)	+0.05/-0.05	(+2/-2 mil)
G	Depanelizing Residual [mm]	0.10	(3.9 mil)	+0.25/-0.10	(+9.8/-3.9 mil)
H	Lateral and Antenna Row Pin to Pin Pitch [mm]	1.0	(39 mil)	+0.05/-0.05	(+2/-2 mil)
I	Lateral and Antenna Row Pin Width [mm]	0.70	(28 mil)	+0.05/-0.05	(+2/-2 mil)
J	Lateral and Antenna Row Pin Height [mm]	1.15	(45.3 mil)	+0.05/-0.05	(+2/-2 mil)
K	Horizontal Pin No1 Edge to Central Pin Edge [mm]	2.78	(109 mil)	+0.05/-0.05	(+2/-2 mil)
L	Vertical Pin No1 Edge to Central Pin Edge [mm]	2.63	(104 mil)	+0.05/-0.05	(+2/-2 mil)
O	Central Pin and Inner Row Width and Height [mm]	0.70	(28 mil)	+0.05/-0.05	(+2/-2 mil)
P	Central Pin to Central Pin Pitch [mm]	1.15	(45.3 mil)	+0.05/-0.05	(+2/-2 mil)
Q	Inner Row Pin to Pin Pitch [mm]	1.1	(43 mil)	+0.05/-0.05	(+2/-2 mil)
R	Horizontal Pin No1 Edge to Antenna Row Pin Edge	8.7	(34 mil)	+0.05/-0.05	(+2/-2 mil)
*	Soldermask defined pads additional height and/or	0.05	(2 mil)	-	-
	Module Weight [g]	<1.0			

Table 17: NINA-B111 mechanical outline data

## 5.2 NINA-B112 Mechanical specifications

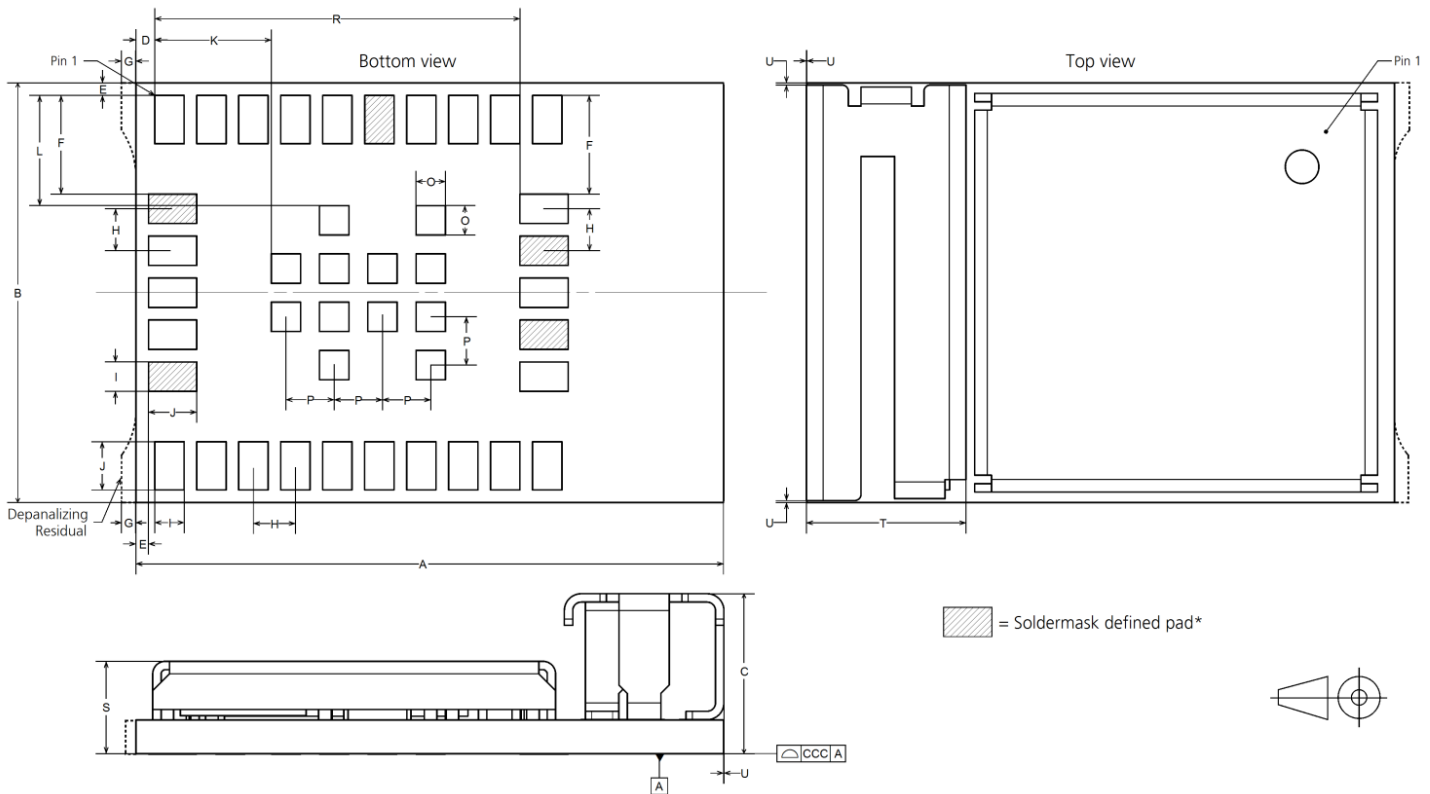

Figure 10: NINA-B112 mechanical outline

Parameter	Description	Typical		Tolerance	
A	Module PCB Length [mm]	14.0	(551 mil)	+0.20/-0.10	(+7.9/-3.9 mil)
B	Module PCB Width [mm]	10.0	(394 mil)	+0.20/-0.10	(+7.9/-3.9 mil)
C	Module Thickness [mm]	3.8	(150 mil)	+0.40/-0.20	(+16/-7.9 mil)
ccc	Seating Plane Coplanarity [mm]	0.10	(3.9 mil)	+0.02/-0.10	(+0.8/-3.9 mil)
D	Horizontal Edge to Lateral Pin No 1 Edge [mm]	0.45	(18 mil)	+0.10/-0.10	(+3.9/-3.9 mil)
E	Vertical and Horizontal Edge to Lateral Pin No 1 Edge	0.30	(12 mil)	+0.10/-0.10	(+3.9/-3.9 mil)
F	Vertical Pin No1 Edge to Lateral Pin Edge [mm]	2.35	(92.5 mil)	+0.05/-0.05	(+2/-2 mil)
G	Depanelizing Residual [mm]	0.10	(3.9 mil)	+0.25/-0.10	(+9.8/-3.9 mil)
H	Lateral and Antenna Row Pin to Pin Pitch [mm]	1.0	(39 mil)	+0.05/-0.05	(+2/-2 mil)
I	Lateral and Antenna Row Pin Width [mm]	0.70	(28 mil)	+0.05/-0.05	(+2/-2 mil)
J	Lateral and Antenna Row Pin Height [mm]	1.15	(45.3 mil)	+0.05/-0.05	(+2/-2 mil)
K	Horizontal Pin No1 Edge to Central Pin Edge [mm]	2.78	(109 mil)	+0.05/-0.05	(+2/-2 mil)
L	Vertical Pin No1 Edge to Central Pin Edge [mm]	2.63	(104 mil)	+0.05/-0.05	(+2/-2 mil)
O	Central Pin and Inner Row Width and Height [mm]	0.70	(28 mil)	+0.05/-0.05	(+2/-2 mil)
P	Central Pin to Central Pin Pitch [mm]	1.15	(45.3 mil)	+0.05/-0.05	(+2/-2 mil)
Q	Inner Row Pin to Pin Pitch [mm]	1.1	(43 mil)	+0.05/-0.05	(+2/-2 mil)
R	Horizontal Pin No1 Edge to Antenna Row Pin Edge	8.7	(34 mil)	+0.05/-0.05	(+2/-2 mil)
S	PCB and Shield Cover Thickness [mm]	2.2	(87 mil)	+0.40/-0.20	(+16/-7.9 mil)
T	Module Antenna Width [mm]	3.8	(150 mil)	+0.20/-0.20	(+7.9/-7.9 mil)
U	Antenna overhang outside module outline on any side	0.0	-	+0.60	(+24 mil)
*	Soldermask defined pads additional height and/or	0.05	(2 mil)	-	-
	Module Weight [g]	<1.0			

Table 18: NINA-B112 mechanical outline data

## 6 Qualification and approvals

### 6.1 Compliance with the RoHS directive



The NINA-B1 series modules comply with the "Directive 2011/65/EU of the European Parliament and the Council on the Restriction of Use of certain Hazardous Substances in Electrical and Electronic Equipment" (RoHS).

No natural rubbers, hygroscopic materials, or materials containing asbestos are employed.

### 6.2 European Union regulatory compliance

Information about European Union regulatory compliance for the NINA-B1 series modules is available in the NINA-B1 Declaration of Conformity [4].

### 6.3 Safety compliance

In order to fulfill the safety standard EN 60950-1, the NINA-B1 series modules must be supplied with a Class-2 Limited Power Source.

### 6.4 FCC and IC Compliance

#### 6.4.1 IC compliance

This device complies with Industry Canada license-exempt RSS standard(s).

Operation is subject to the following two conditions:

1. This device may not cause interference, and
2. This device must accept any interference, including interference that may cause undesired operation of the device.

Under Industry Canada regulations, this radio transmitter may only operate using an antenna of a type and maximum (or lesser) gain approved for the transmitter by Industry Canada. To reduce potential radio interference to other users, the antenna type and its gain should be chosen in such a way that the equivalent isotropically radiated power (e.i.r.p.) is not more than that is necessary for successful communication.

This equipment complies with IC RSS-102 radiation exposure limits set forth for an uncontrolled environment. This equipment should be installed and operated with a minimum distance of 20 cm between the radiator and your body.

#### 6.4.2 Conformité aux normes d'IC

Cet appareil est conforme à la(aux) norme(s) RSS sans licence d'Industry Canada.

Son utilisation est soumise aux deux conditions suivantes:

1. Cet appareil ne doit pas causer d'interférences et
2. il doit accepter toutes interférences reçues, y compris celles susceptibles d'avoir des effets indésirables sur son fonctionnement.

Conformément aux réglementations d'Industry Canada, cet émetteur radio ne peut fonctionner qu'à l'aide d'une antenne dont le type et le gain maximal (ou minimal) ont été approuvés pour cet émetteur par Industry Canada. Pour réduire le risque d'interférences avec d'autres utilisateurs, il faut choisir le type d'antenne et son gain de telle sorte que la puissance isotrope rayonnée équivalente (p.i.r.e) ne soit pas supérieure à celle requise pour obtenir une communication satisfaisante.

Cet équipement respecte les limites d'exposition aux rayonnements IC RSS-102 définies pour un environnement non contrôlé. Il doit être installé et utilisé en maintenant une distance minimum de 20 cm entre le radiateur et votre corps.

### 6.4.3 FCC statement

This device complies with Part 15 of the FCC Rules. Operation is subject to the following two conditions:

1. This device may not cause harmful interference, and
2. This device must accept any interference received, including interference that may cause undesired operation.

 This equipment has been tested and found to comply with the limits for a Class B digital device, pursuant to Part 15 of the FCC Rules. These limits are designed to provide reasonable protection against harmful interference in a residential installation. This equipment generates, uses and can radiate radio frequency energy and, if not installed and used in accordance with the instructions, may cause harmful interference to radio communications. However, there is no guarantee that the interference will not occur in a particular installation. If this equipment does cause harmful interference to radio or television reception, which can be determined by turning the equipment off and on, the user is encouraged to try to correct the interference by one or more of the following measures:

- Reorient or relocate the receiving antenna
- Increase the separation between the equipment and receiver
- Connect the equipment into an outlet on a circuit different from that to which the receiver is connected.



Consult the dealer or an experienced radio/TV technician for help.

The NINA-B1 series modules are for OEM integrations only. The end-user product will be professionally installed in such a manner that only the authorized antennas are used.

For NINA-B111 an external antenna connector (U.FL. connector) reference design (see the NINA-B1 Series System Integration Manual [1]) is available and must be followed to comply with the NINA-B1 FCC/IC modular approval.

Any changes or modifications NOT explicitly APPROVED by u-blox could cause the module to cease to comply with FCC rules part 15, and thus void the user's authority to operate the equipment.

#### 6.4.3.1 Cautions

-  Any changes or modification could cause the module to cease to comply with FCC rules part 15 and thus void the user's authority to operate the equipment.
-  §15.407 statement; in case of absence of information to transmit or operational failure, the NINA-B1 module will automatically discontinue transmission.

### 6.4.4 Labeling requirements for end product

For an end product using the NINA-B1 modules there must be a label containing, at least, the following information:

This device contains  
 FCC ID: XPYNINAB1  
 IC: 8595A-NINAB1

The label must be affixed on an exterior surface of the end product such that it will be visible upon inspection in compliance with the modular approval guidelines developed by the FCC.

In accordance with 47 CFR § 15.19, the end product shall bear the following statement in a conspicuous location on the device:

"This device complies with Part 15 of the FCC Rules. Operation is subject to the following two conditions;

- (1) This device may not cause harmful interference, and
- (2) This device must accept any interference received, including interference that may cause undesired operation."

When the device is so small or for such use that it is not practicable to place the statement above on it, the information shall be placed in a prominent location in the instruction manual or pamphlet supplied to the user or, alternatively, shall be placed on the container in which the device is marketed.

In case, where the final product will be installed in locations where the end-user is not able to see the FCC ID and/or this statement, the FCC ID and the statement shall also be included in the end-product manual.

### 6.4.5 FCC and IC IDs

Model	FCC ID	IC ID
NINA-B111	XPYNINAB1	8595A-NINAB1
NINA-B112	XPYNINAB1	8595A-NINAB1

Table 19: FCC and IC IDs for different models of the NINA-B1 series modules

## 6.5 Japan radio equipment compliance

The NINA-B1 series modules comply with the Japanese Technical Regulation Conformity Certification of Specified Radio Equipment (ordinance of MPT N°. 37, 1981), Article 2, Paragraph 1:

- Item 19 "2.4 GHz band wide band low power data communication system"

When a product integrated with a NINA-B1 module is placed on the Japanese market the product must be affixed with a label with the Giteki marking below. The marking must be visible for inspection.

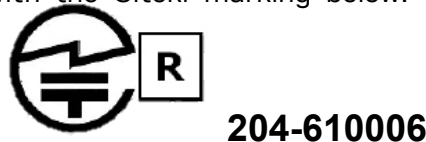

Figure 11: Giteki mark, and the NINA-B1 MIC certification number

The recommended size of the Giteki mark is Ø5.0 mm but the minimum size is Ø3.0 mm.

As the MIC ID is not included on the NINA-B1 series label, the end product holder must also include a copy of the Japan Radio Certificate to the end product technical documentation. Contact the u-blox support for your area as listed in the Contact section to obtain a copy of the radio certificate.

## 6.6 NCC Taiwan compliance

### 6.6.1 Taiwan NCC Warning Statement

- 經型式認證合格之低功率射頻電機，非經許可，公司、商號或使用者均不得擅自變更頻率、加大功率或變更原設計之特性及功能。
- 低功率射頻電機之使用不得影響飛航安全及干擾合法通信；經發現有干擾現象時，應立即停用，並改善至無干擾時方得繼續使用。前項合法通信，指依電信法規定作業之無線電通信。低功率射頻電機須忍受合法通信或工業、科學及醫療用電波輻射性電機設備之干擾。

Statement translation:

- Without permission granted by the NCC, any company, enterprise, or user is not allowed to change frequency, enhance transmitting power or alter original characteristic as well as performance to approved low power radio-frequency devices.
- The low power radio-frequency devices shall not influence aircraft security and interfere legal communications; If found, the user shall cease operating immediately until no interference is achieved. The said legal communications means radio communications is operated in compliance with the Telecommunications Act. The low power radio-frequency devices must be susceptible with the interference from legal communications or ISM radio wave radiated devices.

### 6.6.2 NINA-B111 labeling requirements for end product

When a product containing a NINA-B111 module is placed on the Taiwanese market, the product must be affixed with a label or marking containing at least the following information:



Any similar wording that expresses the same meaning may be used. The marking must be visible for inspection.

### 6.6.3 NINA-B112 labeling requirements for end product

When a product containing a NINA-B112 module is placed on the Taiwanese market, the product must be affixed with a label or marking containing at least the following information:



Any similar wording that expresses the same meaning may be used. The marking must be visible for inspection.

## 6.7 KCC South Korea compliance

When a product containing a NINA-B1 module is placed on the South Korean market, the product must be affixed with a label or marking containing the KC logo and certification number shown in the figure below. This information must also be included in the products user manuals.



The height of the KC logo must be at least 5 mm.

## 6.8 Anatel Brazil compliance

When a product containing a NINA-B1 module is placed on the Brazilian market, the product must be affixed with a label or marking containing the Anatel logo, NINA-B1 Homologation number: 03882-16-05903 and a statement claiming that the device may not cause harmful interference but must accept it (Resolution No 506).





“Este equipamento opera em caráter secundário, isto é, não tem direito a proteção contra interferência prejudicial, mesmo de estações do mesmo tipo, e não pode causar interferência a sistemas operando em caráter primário.”

Statement translation:

“This equipment operates on a secondary basis and, consequently, must accept harmful interference, including from stations of the same kind, and may not cause harmful interference to systems operating on a primary basis.”

When the device is so small or for such use that it is not practicable to place the statement above on it, the information shall be placed in a prominent location in the instruction manual or pamphlet supplied to the user or, alternatively, shall be placed on the container in which the device is marketed.

In case, where the final product will be installed in locations where the end-user is not able to see the Anatel logo, NINA-B1 Homologation number and/or this statement, the Anatel logo, NINA-B1 Homologation number and the statement shall also be included in the end-product manual.

## 6.9 Australia and New Zealand regulatory compliance



The NINA-B1 modules are compliant with AS/NZS 4268:2012/AMDT 1:2013 standard – Radio equipment and systems – Short range devices – Limits and methods of standard measurement made by the Australian Communications and Media Authority (ACMA).

The NINA-B1 module test reports can be used as part of evidence in obtaining permission the Regulatory Compliance Mark (RCM). To meet overall Australian and/or New Zealand compliance on the end product, the integrator must create a compliance folder containing all the relevant compliance test reports.

More information on registration as a Responsible Integrator and labeling requirements will be found at the following websites:

Australian Communications and Media Authority web site <http://www.acma.gov.au/>.

New Zealand Radio Spectrum Management Group web site [www.rsm.govt.nz](http://www.rsm.govt.nz).

## 6.10 South Africa regulatory compliance

The NINA-B1 modules are compliant and certified by the Independent Communications Authority of South Africa (ICASA). End products that are made available for sale or lease or is supplied in any other manner in South Africa shall have a legible label permanently affixed to its exterior surface. The label shall have the ICASA logo and the ICASA issued license number as shown in the figure below. The minimum width and height of the ICASA logo shall be 3 mm. The approval labels must be purchased by the customer’s local representative directly from the approval authority ICASA. A sample of a NINA-B1 ICASA label is included below:



More information on registration as a Responsible Integrator and labeling requirements will be found at the following website:

Independent Communications Authority of South Africa (ICASA) web site - <https://www.icasa.org.za>

## 6.11 Bluetooth qualification information



The NINA-B1 series modules have been qualified according to the Bluetooth version 4.2 and 5.0 specifications. For an end product with NINA-B1 integrated, no further qualification is required. If the end product is to be Bluetooth listed, the QD ID listed in Table 20 shall be included in the end product listing. Use Table 20 to select the QD ID to refer to, depending on what version of the u-blox connectivity software or, for open CPU, what version of the Nordic SoftDevice is used.

Bluetooth version	Bluetooth product type	QD ID	Listing Date	Nordic SoftDevice S132 version	u-Blox connectivity software version
4.2	End Product	85618	16-Aug-2016	3.0.0 to 4.0.x	1.0.0 to 3.0.1
5.0	End Product	100763	18-Sep-2017	5.0.0 or later	4.0.0 or later

**Table 20: NINA-B1 Bluetooth QD IDs**

## 7 Antennas

This chapter gives an overview of the different external antennas that can be used together with the NINA-B1 series modules.

- ⚠** This radio transmitter IC: 8595A-NINAB1 has been approved by Industry Canada to operate with the antenna types listed below with the maximum permissible gain and required antenna impedance for each antenna type indicated. Antenna types not included in this list, having a gain greater than the maximum gain indicated for that type, are strictly prohibited for use with this device.
- ⚠** Cet émetteur radio IC: 8595A-NINAB1 été approuvé par Industry Canada pour fonctionner avec les types d'antenne énumérés ci-dessous avec le gain maximum autorisé et l'impédance nécessaire pour chaque type d'antenne indiqué. Les types d'antenne ne figurant pas dans cette liste et ayant un gain supérieur au gain maximum indiqué pour ce type-là sont strictement interdits d'utilisation avec cet appareil.

For each antenna, the “Approvals” field defines in which region or market the antenna is pre-approved for use with the NINA-B1 series modules. Definitions of the «Approvals» field are:

- FCC – The antenna is approved for use in countries that accept the FCC radio approvals, primarily the US.
- IC – The antenna is approved for use in countries that accept the IC radio approvals, primarily Canada.
- RED – The antenna is approved for use in countries that accept the Radio Equipment Directive, primarily the European countries.
- MIC – The antenna is approved for use in the Japanese market.
- NCC – The antenna is approved for use in the Taiwanese market.
- KCC – The antenna is approved for use in the Korean market.
- ANATEL – The antenna is approved for use in the Brazilian market.
- ACMA – The antenna is approved for use in the Australian and New Zealand markets.
- ICASA – The antenna is approved for use in the South African market.

In general, antennas with SMD connection, Reverse Polarity SMA connector or U.FL connector are approved for use in all the above mentioned markets. The antennas with SMA connector are not approved for use in the US or Canadian markets due to FCC/IC regulations.

### 7.1 Antenna accessories

Name	U.FL to SMA adapter cable
Connector	U.FL and SMA jack (outer thread and pin receptacle)
Impedance	50 Ω
Minimum cable loss	0.5 dB, The cable loss must be above the minimum cable loss to meet the regulatory requirements. Minimum cable length 100 mm.
Comment	The SMA connector can be mounted in a panel. See the NINA-B1 System Integration Manual [1] for information on how to integrate the U.FL connector.
Approval	RED, MIC, NCC, KCC, ANATEL, ACMA and ICASA



<b>Name</b>	<b>U.FL to Reverse Polarity SMA adapter cable</b>	
Connector	U.FL and Reverse Polarity SMA jack (outer thread and pin)	
Impedance	50 $\Omega$	
Minimum cable loss	0.5 dB, The cable loss must be above the minimum cable loss to meet the regulatory requirements. Minimum cable length 100 mm.	
Comment	The Reverse Polarity SMA connector can be mounted in a panel. See the NINA-B1 System Integration Manual [1] for information on how to integrate the U.FL connector. It is required to follow this reference design to comply with the NINA-B1 FCC/IC modular approvals.	
Approval	FCC, IC, RED, MIC, NCC, KCC, ANATEL, ACMA and ICASA	

## 7.2 Approved antennas

### NINA-B112 (u-blox LILY antenna)

Manufacturer	ProAnt	
Gain	+3 dBi	
Impedance	50 $\Omega$	
Size (HxWxL)	3.0 x 3.8 x 9.9 mm	
Type	PIFA	
Comment	SMD PIFA antenna on NINA-B112. Should not be mounted inside a metal enclosure.	
Approval	FCC, IC, RED, MIC, NCC, KCC, ANATEL, ACMA and ICASA	

### GW.26.0111

Manufacturer	Taoglas	
Polarization	Vertical	
Gain	+2.0 dBi	
Impedance	50 $\Omega$	
Size	$\varnothing$ 7.9 x 30.0 mm	
Type	Monopole	
Connector	SMA (M)	
Comment	To be mounted on the U.FL to SMA adapter cable.	
Approval	RED, MIC, NCC, KCC, ANATEL, ACMA and ICASA	

---

**Ex-IT 2400 RP-SMA 28-001**

---

Manufacturer	ProAnt
Polarization	Vertical
Gain	+3.0 dBi
Impedance	50 $\Omega$
Size	$\varnothing$ 12.0 x 28.0 mm
Type	Monopole
Connector	Reverse Polarity SMA plug (inner thread and pin receptacle).
Comment	This antenna must be mounted on a metal ground plane for best performance. To be mounted on the U.FL to Reverse Polarity SMA adapter cable. An SMA version antenna is also available but not recommended for use (Ex-IT 2400 SMA 28-001).
Approval	FCC, IC, RED, MIC, NCC, KCC, ANATEL, ACMA and ICASA



---

**Ex-IT 2400 MHF 28-001**

---

Manufacturer	ProAnt
Polarization	Vertical
Gain	+2.0 dBi
Impedance	50 $\Omega$
Size	$\varnothing$ 12.0 x 28.0 mm
Type	Monopole
Cable length	100 mm
Connector	U.FL. connector
Comment	This antenna must be mounted on a metal ground plane for best performance. To be mounted on a U.FL connector. See the NINA-B1 System Integration Manual [1] for information on how to integrate the U.FL connector. It is required to follow this reference design to comply with the NINA-B1 FCC/IC modular approvals.
Approval	FCC, IC, RED, MIC, NCC, KCC, ANATEL, ACMA and ICASA



---

**Ex-IT 2400 RP-SMA 70-002**

---

Manufacturer	ProAnt
Polarization	Vertical
Gain	+3.0 dBi
Impedance	50 $\Omega$
Size	$\varnothing$ 10 x 83 mm
Type	Monopole
Connector	Reverse Polarity SMA plug (inner thread and pin receptacle)
Comment	To be mounted on the U.FL to Reverse Polarity SMA adapter cable. An SMA version antenna is also available but not recommended for use (Ex-IT 2400 SMA 70-002).
Approval	FCC, IC, RED, MIC, NCC, KCC, ANATEL, ACMA and ICASA



---

**InSide-2400**

---

Manufacturer	ProAnt
Gain	+3.0 dBi
Impedance	50 $\Omega$
Size	27 x 12 mm (triangular)
Type	Patch
Cable length	100 mm
Connector	U.FL. connector
Comment	Part of this antenna should be attached to a plastic enclosure for best performance. To be mounted on a U.FL connector. See the NINA-B1 System Integration Manual [1] for information on how to integrate the U.FL connector. It is required to follow this reference design to comply with the NINA-B1 FCC/IC modular approvals.
Approval	FCC, IC, RED, MIC, NCC, KCC, ANATEL, ACMA and ICASA



---

**FlatWhip-2400 RP-SMA**

---

Manufacturer	ProAnt
Gain	+3.0 dBi
Impedance	50 $\Omega$
Size	$\varnothing$ 50.0 x 30.0 mm
Type	Monopole
Connector	Reverse Polarity SMA plug (inner thread and pin receptacle).
Comment	To be mounted on the U.FL to SMA adapter cable. An SMA version antenna is also available but not recommended for use (FlatWhip-2400 SMA).
Approval	FCC, IC, RED, MIC, NCC, KCC, ANATEL, ACMA and ICASA



## 8 Product handling

### 8.1 Packaging

The NINA-B1 series modules are delivered as hermetically sealed, reeled tapes to enable efficient production, production lot set-up and tear-down. For more information about packaging, see the u-blox Package Information Guide [2].

#### 8.1.1 Reels

NINA-B1 modules are deliverable in quantities of 500 pieces on a reel. The reel types for the NINA-B1 modules are provided in Table 21 and detailed information about the reel types are described in u-blox Package Information Guide [2].

Model	Reel Type
NINA-B111	B
NINA-B112	A

Table 21: Reel types for different models of the NINA-B1 series

#### 8.1.2 Tapes

Figure 12 and Figure 13 shows the position and orientation of the NINA-B1 modules as they are delivered on tape. The dimensions of the tapes are specified in Figure 14 and Figure 15.



Figure 12: Orientation of NINA-B111 modules on tape



Figure 13: Orientation of NINA-B112 modules on tape

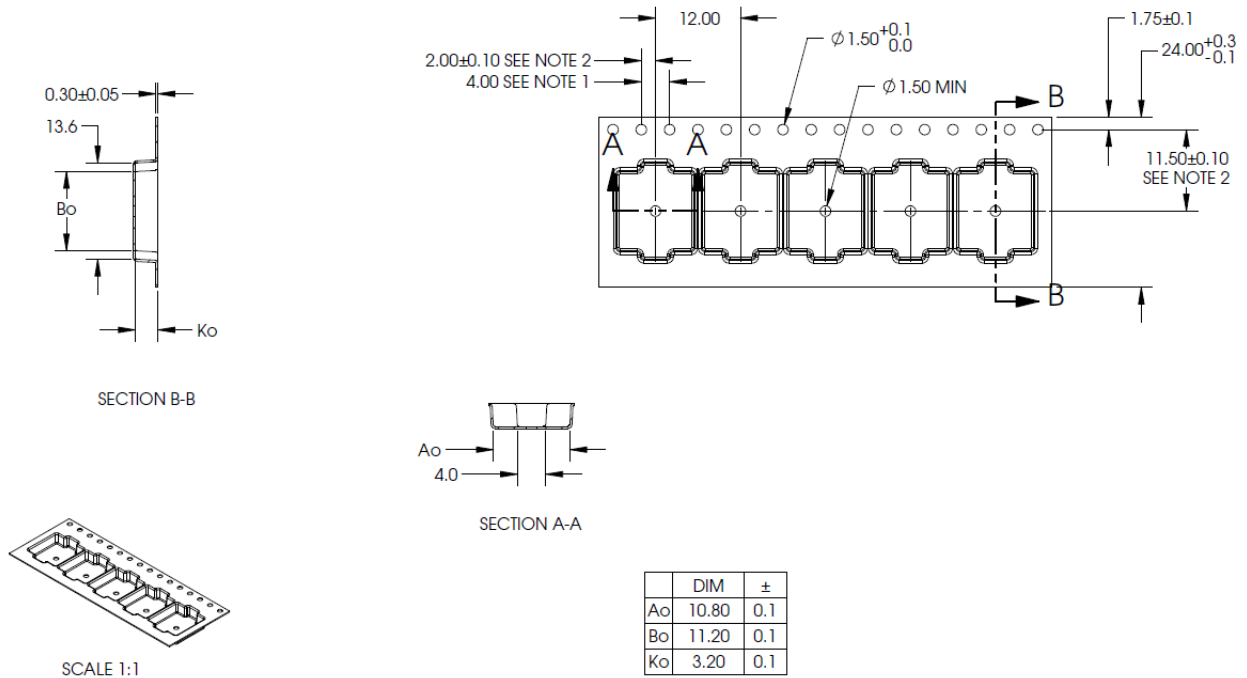

NOTES:

1. 10 SPROCKET HOLE PITCH CUMULATIVE TOLERANCE ±0.2
2. POCKET POSITION RELATIVE TO SPROCKET HOLE MEASURED AS TRUE POSITION OF POCKET, NOT POCKET HOLE.
3. Ao AND Bo ARE MEASURED ON A PLANE AT A DISTANCE "R" ABOVE THE BOTTOM OF THE POCKET.

Figure 14: NINA-B111 tape dimensions

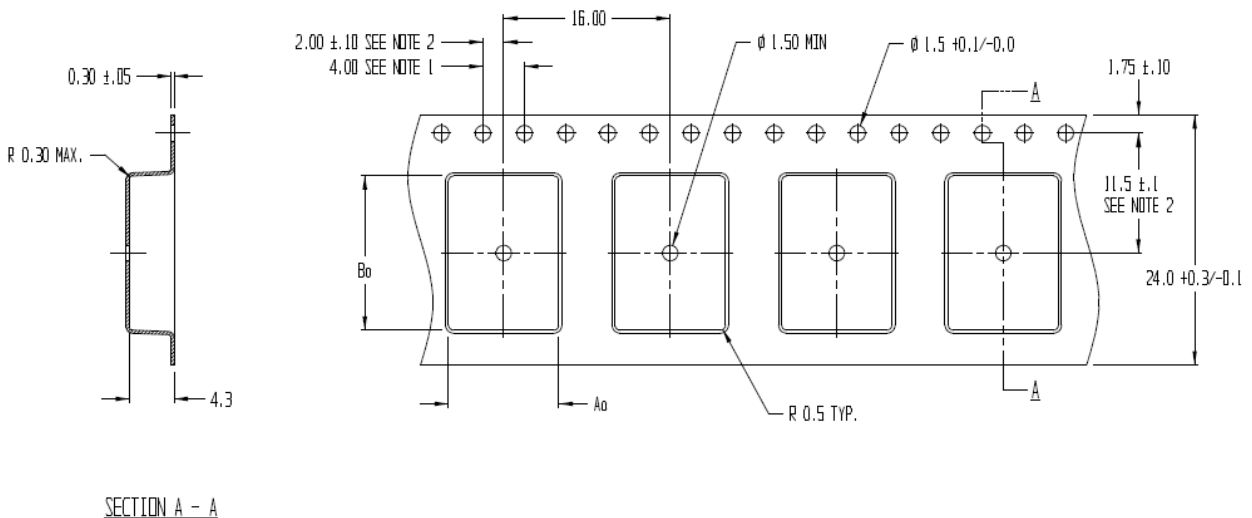

Ao = 10.6  
Bo = 14.8  
Ko = 4.3

NOTES:

1. 10 SPROCKET HOLE PITCH CUMULATIVE TOLERANCE ±0.2
2. POCKET POSITION RELATIVE TO SPROCKET HOLE MEASURED AS TRUE POSITION OF POCKET, NOT POCKET HOLE
3. Ao AND Bo ARE CALCULATED ON A PLANE AT A DISTANCE "R" ABOVE THE BOTTOM OF THE POCKET.

Figure 15: NINA-B112 tape dimensions



## 8.2 Moisture sensitivity levels

-  The NINA-B1 series modules are Moisture Sensitive Devices (MSD) in accordance with the IPC/JEDEC specification.

The Moisture Sensitivity Level (MSL) relates to the required packaging and handling precautions. The NINA-B1 series modules are rated at MSL level 4. For more information regarding moisture sensitivity levels, labeling and storage, see the u-blox Package Information Guide [2].

-  For MSL standards, see IPC/JEDEC J-STD-020, which can be downloaded from [www.jedec.org](http://www.jedec.org).

## 8.3 Reflow soldering

Reflow profiles are to be selected according to u-blox recommendations. See NINA-B1 Series System Integration Manual [1] for more information.

-  Failure to observe these recommendations can result in severe damage to the device.

## 8.4 ESD precautions

-  The NINA-B1 series modules contain highly sensitive electronic circuitry and are Electrostatic Sensitive Devices (ESD). Handling the NINA-B1 series modules without proper ESD protection may destroy or damage them permanently.

The NINA-B1 series modules are electrostatic sensitive devices (ESD) and require special ESD precautions typically applied to ESD sensitive components. Section 4.1.1 provides the maximum ESD ratings of the NINA-B1 series modules.

Proper ESD handling and packaging procedures must be applied throughout the processing, handling and operation of any application that incorporates the NINA-B1 series module. The ESD precautions should be implemented on the application board where the module is mounted as described in the NINA-B1 Series System Integration Manual [1].

-  Failure to observe these recommendations can result in severe damage to the device.

## 9 Labeling and ordering information

### 9.1 Product labeling

The labels of the NINA-B1 series modules include important product information as described in this section. Figure 16 illustrates the label of all the NINA-B1 series modules, which includes u-blox logo, production lot, product type number and certification numbers (if applicable).



Figure 16: Location of product type number on the NINA-B1 series module label

Reference	Description
1	Date of unit production (year/week)
2	Product version
3	Product name
4	Data Matrix with unique serial number of 19 alphanumeric symbols. The first 3 symbols represent the unique module type no. 683: NINA-B111 and 684: NINA-B112, the next 12 symbols represent the unique hexadecimal Ethernet MAC address of the module AABBCDDDEEFF, and the last 4 symbols represent the hardware and firmware version encoded HFFF.

Table 22: NINA-B1 series label description

### 9.2 Explanation of codes

Three different product code formats are used. The **Product Name** is used in documentation such as this data sheet and identifies all u-blox products, independent of packaging and quality grade. The **Ordering Code** includes options and quality, while the **Type Number** includes the hardware and software versions. Table 23 below details these three different formats:

Format	Structure
Product Name	PPPP-TGVV
Ordering Code	PPPP-TGVV-TTQ
Type Number	PPPP-TGVV-TTQ-XX

Table 23: Product code formats

Table 24 explains the parts of the product code.

Code	Meaning	Example
PPPP	Form factor	NINA
TG	Platform (Technology and Generation) T – Dominant technology, For example, W: Wi-Fi, B: Bluetooth G - Generation	B1: Bluetooth Generation 1
VV	Variant based on the same platform; range [00...99]	11: default mounting, with antenna pin
TT	Major Product Version	00: first revision
Q	Quality grade A: Automotive B: Professional C: Standard	B: professional grade
XX	Minor product version (not relevant for certification)	Default value is 00

**Table 24: Part identification code**

## 9.3 Ordering information

Ordering Code	Product
NINA-B111-00B	NINA-B1 module with antenna pin, preflashed with u-blox connectivity software v1.0.0
NINA-B111-01B	NINA-B1 module with antenna pin, preflashed with u-blox connectivity software v2.0.0
NINA-B111-02B	NINA-B1 module with antenna pin, preflashed with u-blox connectivity software v3.0.1
NINA-B111-03B	NINA-B1 module with antenna pin, preflashed with u-blox connectivity software v4.0.0
NINA-B112-00B	NINA-B1 module with internal antenna, preflashed with u-blox connectivity software v1.0.0
NINA-B112-01B	NINA-B1 module with internal antenna, preflashed with u-blox connectivity software v2.0.0
NINA-B112-02B	NINA-B1 module with internal antenna, preflashed with u-blox connectivity software v3.0.1
NINA-B112-03B	NINA-B1 module with internal antenna, preflashed with u-blox connectivity software v4.0.0

**Table 25: Product ordering codes**

# Appendix

## A Glossary

Abbreviation	Definition
ADC	Analog to Digital Converter
BLE	Bluetooth Low Energy
BPF	Band Pass Filter
CTS	Clear To Send
ESD	Electro Static Discharge
FCC	Federal Communications Commission
GATT	Generic ATtribue profile
GPIO	General Purpose Input/Output
IC	Industry Canada
I2C	Inter-Integrated Circuit
MCU	Micro Controller Unit
MSD	Moisture Sensitive Device
SPI	Serial Peripheral Interface
UART	Universal Asynchronous Receiver/Transmitter

**Table 26: Explanation of the abbreviations and terms used**

## Related documents

- [1] NINA-B1 Series System Integration Manual, document number UBX-15026175
- [2] u-blox Package Information Guide, document number UBX-14001652
- [3] u-blox Short Range AT Commands Manual, document number UBX-14044127
- [4] NINA-B1 Declaration of Conformity, document number UBX-16022176
- [5] NINA-B1 Getting Started, document number UBX-16009942
- [6] NINA-B1 Product Summary, document number UBX-15018552

 For regular updates to u-blox documentation and to receive product change notifications, register on our homepage ([www.u-blox.com](http://www.u-blox.com)).

## Revision history

Revision	Date	Name	Comments
R01	5-Nov-2015	ajoh, fbro	Initial release.
R02	22-Feb-2016	ajoh	In Figure 1, replaced GPIO(s) with NFC. Modified Figure 2. Added a new section for NFC (section 2.2.2) and included pin description for NFC in Table 6 and Table 7. Added Real Time Counter section (section 2.3.6). Modified sections 2.4.2, 2.5, and 2.6. Split the pin-out section into mbed/platform (section 3.1) and SPA (section 3.2) and updated these sections. Updated Figure 3. Updated NINA-B112 radio performance. Updated mechanical dimensions (section 5) Modified the number of pieces on a reel to 500 in section 8.1.1.
R03	19-Apr-2016	ajoh	Modified the supported Serial peripheral interface (section 2.4.2).
R04	17-Jun-2016	ajoh, fbro, mhan, kgom	Renamed Serial Port Application as NINA-B11x firmware. Updated the pin-out (section 3), added extra information about NFC pins and added section 2.7. Switched places of DSR and DTR pins in B11x firmware pin-out, updated system functions text (section 2.3), added measurements to electrical specifications (section 4), and a few minor changes. Included figures for tape orientation and tape dimensions in section 8.1.2. Added approved antennas list (chapter 7). Document status changed to Advance Information.
R05	09-Aug-2016	ajoh	Added radiation patterns for NINA-B112 (section 4.2.4.1). Further described features tied to the u-blox connectivity software (section 2.7). Added new product qualifications and type approvals (section 6), and updated the approved antennas list (chapter 7). Added information about the available debug interfaces (section 2.8). Changed the document status to Early Production Information.
R06	28-Feb-2017	ajoh, kgom	Added hardware and software option (sections 1.5 and 1.6). Added Bluetooth address information (section 1.7). Removed the 'supported features' section and table. Clarified the module pinout used by the u-blox connectivity software. Added information about the exposed GND pins in the center of the module in section 3. Corrected information in Table 7 (SWITCH_1 is not used to restore UART settings). Added current consumption data when powering NINA-B1 with 1.8 V in Table 13. Added detailed tolerances information to the mechanical dimensions (section 5). Added type approval information for Taiwan, South Korea, Brazil, Australia/New Zealand, and South Africa (section 6). Corrected a typo in Table 16 (max value for high level input characteristic is VCC, not 0) and in Table 5 (blue RGB led color is caused by low signal on BLUE not RED). On page 2, added type numbers for u-blox connectivity software v2.0.0; replaced Document status with Disclosure restriction.
R07	16-May-2017	kgom	Minor updates.
R08	29-Jun-2017	ajoh, kgom	Updated Table 1. Updated product status to Mass Production. Added more information in the Block Diagram (Figure 1). Added information about I2S (section 2.4.4) and PWM (section 2.5.1) interfaces. Increased the number of

Revision	Date	Name	Comments
			analog capable pins to 8 (previously 7); the new pin was previously intended for another use. Updated section 3.1. Included ordering codes for -02B version in Table 25 and type numbers on page 2. In section 2.7, clarified that system signals indicate SPS connections only and added information about how the DTR pin can be used. Added information about the contents of the label DataMatrix bar code to Table 22.
R09	24-Apr-2018	ajoh, lalb, kgom	<p>Added new software version 4.0.0: New ordering codes/type numbers in the last table on page 2. Updated Table 1 and section 2.7 with new features. Added information about IO signals (section 2.7.5). Added I/O signals to the pin-out for u-blox connectivity software (Table 7) (used to be RSVD). Included ordering codes for -03B version in Table 25.</p> <p>Included support for Bluetooth version 5. Clarified information on Bluetooth qualification (section 6.11) and included Bluetooth v5 QD ID. Added notes that country approvals for Bluetooth 5 are still pending for Japan and Korea. A few minor changes based on the latest brand guidelines of Arm Mbed. Updated the product status for the ordering codes/type numbers ending with -02B-00 to Mass Production in the last table on page 2.</p>
R10	8-Aug-2018	lalb, kgom	Updated that the country approvals for Bluetooth 5 in Japan and Korea have been completed (by removing the notes that those country approvals previously were pending).
R11	21-Nov-2018	kgom	Updated the product status for the ordering codes/type numbers ending with -03B-00 to Mass Production in the last table on page 2.
R12	2-Jan-2019	ajoh	Changed the format of the approved antennas list (chapter 7) to align with other u-blox products.

# Contact

For complete contact information, visit us at [www.u-blox.com](http://www.u-blox.com).

## u-blox Offices

### North, Central and South America

#### u-blox America, Inc.

Phone: +1 703 483 3180  
E-mail: [info\\_us@u-blox.com](mailto:info_us@u-blox.com)

#### Regional Office West Coast:

Phone: +1 408 573 3640  
E-mail: [info\\_us@u-blox.com](mailto:info_us@u-blox.com)

#### Technical Support:

Phone: +1 703 483 3185  
E-mail: [support@u-blox.com](mailto:support@u-blox.com)

### Headquarters

#### Europe, Middle East, Africa

#### u-blox AG

Phone: +41 44 722 74 44  
E-mail: [info@u-blox.com](mailto:info@u-blox.com)  
Support: [support@u-blox.com](mailto:support@u-blox.com)

### Asia, Australia, Pacific

#### u-blox Singapore Pte. Ltd.

Phone: +65 6734 3811  
E-mail: [info\\_ap@u-blox.com](mailto:info_ap@u-blox.com)  
Support: [support\\_ap@u-blox.com](mailto:support_ap@u-blox.com)

#### Regional Office Australia:

Phone: +61 2 8448 2016  
E-mail: [info\\_anz@u-blox.com](mailto:info_anz@u-blox.com)  
Support: [support\\_ap@u-blox.com](mailto:support_ap@u-blox.com)

#### Regional Office China (Beijing):

Phone: +86 10 68 133 545  
E-mail: [info\\_cn@u-blox.com](mailto:info_cn@u-blox.com)  
Support: [support\\_cn@u-blox.com](mailto:support_cn@u-blox.com)

#### Regional Office China (Chongqing):

Phone: +86 23 6815 1588  
E-mail: [info\\_cn@u-blox.com](mailto:info_cn@u-blox.com)  
Support: [support\\_cn@u-blox.com](mailto:support_cn@u-blox.com)

#### Regional Office China (Shanghai):

Phone: +86 21 6090 4832  
E-mail: [info\\_cn@u-blox.com](mailto:info_cn@u-blox.com)  
Support: [support\\_cn@u-blox.com](mailto:support_cn@u-blox.com)

#### Regional Office China (Shenzhen):

Phone: +86 755 8627 1083  
E-mail: [info\\_cn@u-blox.com](mailto:info_cn@u-blox.com)  
Support: [support\\_cn@u-blox.com](mailto:support_cn@u-blox.com)

#### Regional Office India:

Phone: +91 80 405 092 00  
E-mail: [info\\_in@u-blox.com](mailto:info_in@u-blox.com)  
Support: [support\\_in@u-blox.com](mailto:support_in@u-blox.com)

#### Regional Office Japan (Osaka):

Phone: +81 6 6941 3660  
E-mail: [info\\_jp@u-blox.com](mailto:info_jp@u-blox.com)  
Support: [support\\_jp@u-blox.com](mailto:support_jp@u-blox.com)

#### Regional Office Japan (Tokyo):

Phone: +81 3 5775 3850  
E-mail: [info\\_jp@u-blox.com](mailto:info_jp@u-blox.com)  
Support: [support\\_jp@u-blox.com](mailto:support_jp@u-blox.com)

#### Regional Office Korea:

Phone: +82 2 542 0861  
E-mail: [info\\_kr@u-blox.com](mailto:info_kr@u-blox.com)  
Support: [support\\_kr@u-blox.com](mailto:support_kr@u-blox.com)

#### Regional Office Taiwan:

Phone: +886 2 2657 1090  
E-mail: [info\\_tw@u-blox.com](mailto:info_tw@u-blox.com)  
Support: [support\\_tw@u-blox.com](mailto:support_tw@u-blox.com)

## X-ON Electronics

Largest Supplier of Electrical and Electronic Components

*Click to view similar products for [Bluetooth Modules - 802.15.1 category](#):*

*Click to view products by [U-Blox manufacturer](#):*

Other Similar products are found below :

[A2541R24A10GM](#) [CYBLE-212023-10](#) [BM78SPP05MC2-0002AA](#) [CYW20732S](#) [968EMB0019](#) [TB-03F-AT\\_Mesh](#) [ENW89857A1KF](#)  
[ENW49D01A1KF](#) [SPB228-D-1](#) [88980124](#) [NINA-B222-03B](#) [1327](#) [RN42HID-I/RM](#) [ENW-89829C3KF](#) [BLE113-A-V1](#) [SPBTLE-RFTR](#)  
[BM70BLE01FC2-0B03AA](#) [ACN52832](#) [A2541E24A10GM](#) [450-0168R](#) [MOTG-BLUETOOTH](#) [ABBTM-2.4GHz-52-T](#) [ABBTM-2.4GHz-T](#)  
[ABBTM-2.4GHz-T2](#) [ACN52840](#) [4076](#) [AFERO-BL24-01](#) [BLED112](#) [BM62SPKS1MC2-0001AA](#) [BM78SPPS5MC2-0002AA](#) [PX0880/1](#)  
[DAT12](#) [DG100 IOT EDGE GATEWAY](#) [BT680F](#) [PBA31309V1.00 S LK64](#) [E73-2G4M08S1CX](#) [ATSAMB11-MR510CA](#)  
[BM20SPKA1NBC-0001AA](#) [BM20SPKS1NBC-0001AA](#) [BM23SPKS1NB9-0B02AA](#) [BM70BLE01FC2-0B04AA](#) [BM77SPP03MC2-0007AA](#)  
[BM77SPP03MC2-0008AA](#) [BM78SPPS5NC2-0002AA](#) [BM83SM1-00TA](#) [DM164146](#) [RN42NU-IRM](#) [RN42U-I/RM](#) [RN42XVP-I/RM](#)  
[RN4678-V/RM113](#)