

NORA-W2 series

Stand-alone multiradio modules

Data sheet



Abstract

This technical data sheet describes the NORA-W2 series stand-alone multiradio modules. NORA-W2 modules come with pre-flashed application software, Wi-Fi (802.11b/g/n). NORA-W2 has several important embedded security features, including secure boot which ensures that only authenticated software can run on the module. The modules are ideal for critical IoT applications where security is important.



Document information

Title	NORA-W2 series	
Subtitle	Stand-alone multiradio modules	
Document type	Data sheet	
Document number	UBX-21046925	
Revision and date	R04	19-Dec-2023
Disclosure restriction	C1 – Public	

Product status	Corresponding content status	
Functional sample	Draft	For functional testing. Revised and supplementary data will be published later.
In development / Prototype	Objective Specification	Target values. Revised and supplementary data will be published later.
Engineering sample	Advance Information	Data based on early testing. Revised and supplementary data will be published later.
Initial production	Early Production Information	Data from product verification. Revised and supplementary data may be published later.
Mass production / End of life	Production Information	Document contains the final product specification.

This document applies to the following products:

Product name	Type number	Software version	Hardware version	PCN ref.	Product status
NORA-W251AWS	NORA-W251AWS-00B-00	1.1 (upgradeable to 1.2)	04	N/A	Initial Production
NORA-W256AWS	NORA-W256AWS-00B-00	1.1 (upgradeable to 1.2)	04	N/A	Initial production

u-blox or third parties may hold intellectual property rights in the products, names, logos and designs included in this document. Copying, reproduction, or modification of this document or any part thereof is only permitted with the express written permission of u-blox. Disclosure to third parties is permitted for clearly public documents only.

The information contained herein is provided "as is". No warranty of any kind, either express or implied, is made in relation to the accuracy, reliability, fitness for a particular purpose or content of this document. This document may be revised by u-blox at any time. For most recent documents, please visit www.u-blox.com.

Copyright © u-blox AG.

Contents

Document information	2
Contents	3
1 Functional description	5
1.1 Overview.....	5
1.2 Applications	5
1.3 Block diagram	6
1.4 Product variants.....	6
1.4.1 NORA-W251AWS.....	6
1.4.2 NORA-W256AWS.....	6
1.5 Radio performance	7
1.6 CPU.....	7
1.6.1 Software options	7
1.7 IEEE 802.11d and additional regulatory domains.....	8
1.7.1 NORA-W2 IEEE 802.11d implementation description	8
2 Interfaces	10
2.1 Power supply	10
2.1.1 Module supply input (VCC)	10
2.1.2 Digital I/O interfaces reference voltage (VCC_IO).....	10
2.2 System functions.....	10
2.2.1 Module reset	10
2.3 RF antenna interface.....	10
2.3.1 Internal antenna.....	11
2.3.2 External RF antenna interface.....	11
2.4 IO signals.....	11
2.4.1 Drive capability	11
2.4.2 System status IO signals	11
2.4.3 UART	12
3 Pin definition	13
3.1 NORA-W2 pin assignment.....	13
3.2 Pinout	13
4 Electrical specifications	15
4.1 Absolute maximum ratings	15
4.1.1 Maximum ESD ratings.....	15
4.2 Operating conditions.....	15
4.2.1 Operating temperature range.....	15
4.2.2 Supply/Power pins	16
4.2.3 RESET_N pin.....	16
4.2.4 Digital pins.....	16
4.2.5 Current consumption.....	17
4.2.6 Wi-Fi radio characteristics.....	17

4.2.7 Bluetooth Low Energy characteristics	18
4.2.8 Antenna radiation patterns.....	19
5 Mechanical specifications	21
5.1 NORA- W256AWS mechanical specifications.....	21
5.2 NORA-W251AWS mechanical specifications	21
6 Qualification and approvals.....	23
6.1 Country approvals.....	23
6.2 Bluetooth qualification.....	23
7 Product handling.....	24
7.1 Packaging	24
7.1.1 Reels	24
7.1.2 Tapes.....	24
7.2 Moisture sensitivity levels.....	25
7.3 Reflow soldering	25
7.4 ESD precautions.....	25
8 Labeling and ordering information	26
8.1 Product labeling.....	26
8.2 Product identifiers	27
8.3 Identification codes	27
8.4 Ordering information.....	27
Appendix	28
A Glossary	28
Related documents	29
Revision history	29
Contact.....	29

1 Functional description

1.1 Overview

The NORA-W2 series are stand-alone multiradio modules integrating a powerful 32-bit, dual-core microcontroller unit (MCU) and a radio for wireless communication. The radio supports Wi-Fi 802.11b/g/n in the 2.4 GHz ISM band and Bluetooth Low Energy 5.

The embedded AWS IoT ExpressLink compliant software includes secured certificates that are pre-flashed in the modules. The module offers “out of the box” connectivity with Amazon Web Services (AWS), so that your customers can benefit from convenient cloud access to applications and all other services that AWS provides. NORA-W2 also supports secure over-the air (OTA) updates of both the module firmware and the host application. Control and data communication with the module is performed with stateless AT-commands over a serial interface.

NORA-W2 includes a wireless MCU, flash memory, and crystal. It also includes components for antenna matching, filtering, and decoupling – making it a very compact stand-alone multiradio module. The module is designed with secure boot, which ensures the module boots up only in the presence of authenticated software. The small size and the embedded security capabilities make NORA-W2 ideal for critical IoT applications, where security is important. Intended applications include consumer products, telematics, low power sensors, connected factories, connected buildings (appliances and surveillance), point-of-sales, and health devices.

The NORA-W2 series is globally certified, which reduces time to market for the end-product. To ensure operation in harsh professional environments, the modules are industrial grade and qualified according to ISO 16750, supporting temperature range of –40 °C to +85 °C.

1.2 Applications

NORA-W2 series are suitable for a wide range of applications, including:

- Wi-Fi networks
- Internet of Things (IoT)
- Telematics
- Point-of-sales
- Medical and industrial networks
- Home/building automation apps

1.3 Block diagram

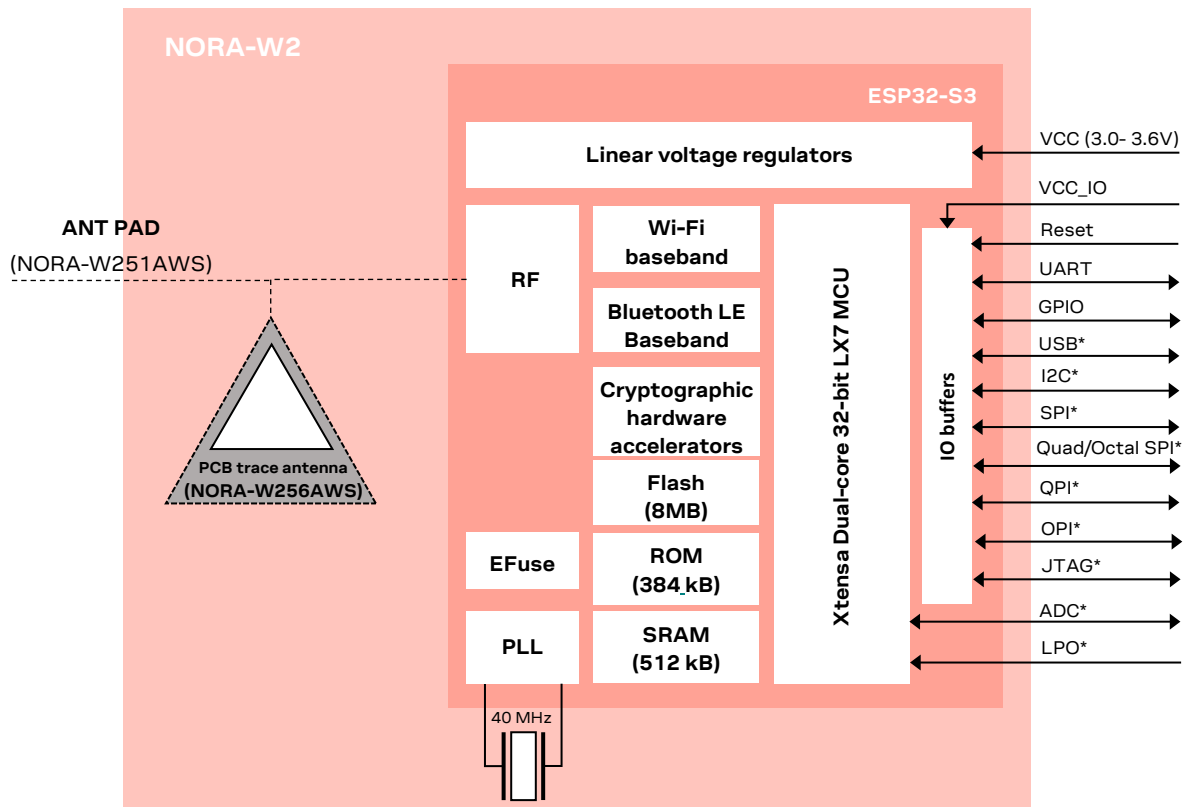

*Not supported by current software.

Figure 1: NORA-W2 series block diagram

1.4 Product variants

NORA-W2 series modules come with pre-flashed application software, supporting Wi-Fi 802.11b/g/n 2.4 GHz ISM band. The host system can set up and control the module through the AT command interface. See also the AWS IoT ExpressLink AT commands manual available from the AWS developer page [\[6\]](#).

1.4.1 NORA-W251AWS

The NORA-W251AWS module has no internal antenna, but the RF signal for routing to an external antenna or antenna connector signal is exposed through a dedicated module pin instead. The module outline is 10.4 x 14.3 mm with a height of 1.9 mm.

1.4.2 NORA-W256AWS

The NORA-W256AWS module is equipped with an internal PCB trace antenna, using antenna technology licensed from Abracon. The RF signal is not connected to any module pin. The module outline is 10.4 x 14.3 mm with a height of 1.9 mm.

1.5 Radio performance

NORA-W2 series (NORA-W251AWS and NORA-W256AWS) modules support Wi-Fi and are conformant with IEEE 802.11b/g/n single-band 2.4 GHz operation and Bluetooth Low Energy specifications, as shown in [Table 1](#).

Wi-Fi	Bluetooth Low Energy
IEEE 802.11b/g/n	Bluetooth 5.0
Band support Station mode: 2.4 GHz, channel 1-13* Access Point mode: 2.4 GHz, channel 1-13*	Band support 2.4 GHz, 40 channels
Typical conducted output power: 17 dBm	Typical conducted output power 7 dBm
Typical radiated output power: 20 dBm EIRP**	Typical radiated output power 10 dBm EIRP**
Conducted sensitivity -97 dBm	Conducted sensitivity -98 dBm
Data rates: IEEE 802.11b: 1 / 2 / 5.5 / 11 Mbit/s IEEE 802.11g: 6 / 9 / 12 / 18 / 24 / 36 / 48 / 54 Mbit/s IEEE 802.11n: MCS 0-7, HT20, HT40	Data rates: 1 / 2 Mbit/s 125 / 500 Kbit/s

* Maximum support for 802.11d depends on the region.

** RF power including maximum antenna gain (3 dBi).

Table 1: NORA-W2 series Wi-Fi and Bluetooth characteristics

1.6 CPU

NORA-W2 series modules have a dual-core system with two Harvard Architecture Xtensa LX7 CPUs operating at a maximum 240 MHz internal clock frequency.

The main features of the internal NORA-W2 memory include:

- 384 KB ROM for booting and core functions.
- 512 KB SRAM for data and instruction.
- 8 MB FLASH for code storage, including hardware encryption to protect programs.
- 4 kbit EFUSE (non-erasable memory) for MAC addresses, module configuration, flash encryption, and chip ID.

NORA-W2 series modules can be used to design solutions with top-grade security. Including integrated cryptographic hardware accelerators, the modules feature secure boot functionality that ensures that the module can only be restarted with authenticated software.

1.6.1 Software options

NORA-W2 series modules come with the pre-flashed application software, supporting IEEE 802.11 b/g/n single-band 2.4 GHz operation. The host system can set up and control the module through the AT command interface. NORA-W2 modules provide top-grade security, thanks to secure boot, which ensures the module boots up only with original AWS IoT ExpressLink software.

1.7 IEEE 802.11d and additional regulatory domains

NORA-W2 series modules support the IEEE 802.11d wireless network standard, which extends the original IEEE 802.11 specification to include support for “additional regulatory domains”.

NORA-W2 -based devices configure automatically to operate in accordance regulatory domains.

By passively scanning (listening) for beacons available wireless networks, NORA-W2 modules identify the channels supported by each network and determine the best access point with which to connect. The modules configure automatically to operate in accordance with the policies and regulations of the regional domain in which they operate.

Passive scans are performed once on startup and then once every hour. After the first passive scan the channel list is filtered in accordance with 802.11d.

1.7.1 NORA-W2 IEEE 802.11d implementation description

When used as Wi-Fi stations, NORA-W2 modules passively scan access point (AP) beacons at start-up. A new scan is performed every hour to update the regulatory domain. The algorithm is restarted when the module is turned on or reset. It is not possible to override the algorithm described by reconfiguring the device.

The beacons include information elements that describe the country name, data rates, channel quantity, signal strength, and maximum transmission level of the wireless network that they represent. Based on the information received from the beacons, the modules compare APs and choose which one to use. NORA-W2 modules configure automatically to operate on all bands supported in the regulatory domain of the chosen AP, as shown in [Table 2](#).

NORA-W2 supports the following three domains:

- **FCC:** This is the regulatory body for products used in the US. If the scan results include country information pertaining solely to the FCC the regulatory domain is set to FCC.
- **ETSI and UKCA:** This is the regulatory domain for the products sold primarily in Europe and Great Britain. If at least one scan result contains country information pertaining to non-FCC countries, and no other contrary information is received, the regulatory domain is set to ETSI and UKCA.
- **WORLD:** In this domain, NORA-W2 modules operate on all channels supported both by FCC, ETSI, UKCA, and most other countries in the world. This is the initial regulatory domain. If subsequent scans contain country information for both FCC and non-FCC countries, the regulatory domain is always set to WORLD. In [Figure 2](#) this state is shown as WORLD-FINAL. This state is not exited until the device is reset.

The state transition diagram shown in [Figure 2](#) describes the algorithm for selecting the current regulatory domain.

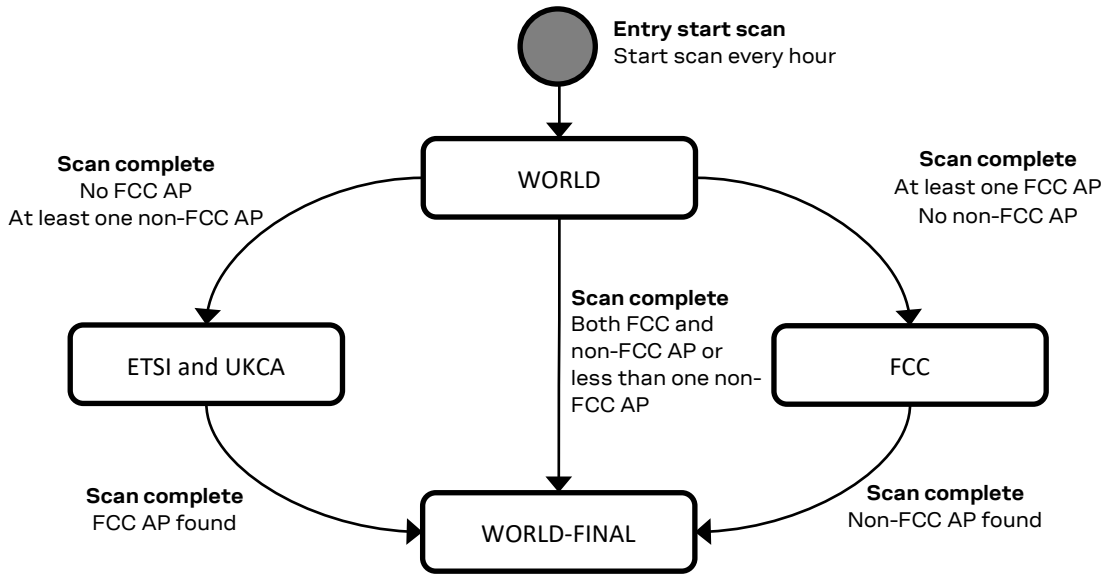

Figure 2: NORA-W2 series IEEE 802.11d state transition diagram

[Table 2](#) shows the channels that are supported in the different regulatory domains.

Regulatory domain	Band	Tx channels
WORLD	2.4 GHz	1, 2, 3, 4, 5, 6, 7, 8, 9, 10, 11
ETSI and UKCA	2.4 GHz	1, 2, 3, 4, 5, 6, 7, 8, 9, 10, 11, 12, 13
FCC	2.4 GHz	1, 2, 3, 4, 5, 6, 7, 8, 9, 10, 11

Table 2: Channel list for supported regulatory domains

The maximum output power is reduced on some channels depending on regulatory requirements. For example, frequency band edge requirements can limit the output power on channels close to band edges.

2 Interfaces

2.1 Power supply

The power for NORA-W2 series modules is supplied through **VCC** and **VCC_IO** pins by DC voltage.

-  The system power supply circuit must be able to support peak power. As the current drawn from **VCC** and **VCC_IO** can vary significantly based on Wi-Fi power consumption profiles.

2.1.1 Module supply input (VCC)

NORA-W2 series modules use an integrated Linear Voltage converter to transform and stabilize the supply voltage applied to the **VCC** pin.

2.1.2 Digital I/O interfaces reference voltage (VCC_IO)

NORA-W2 series modules support an additional supply input for setting the I/O voltage level.

The separate **VCC_IO** pin enables integration of the module into applications with different voltage levels without any level converters. NORA-W2 modules currently support a 3.3 V IO voltage level only.

2.2 System functions

NORA-W2 series modules are power efficient devices capable of operating in power saving mode. The following system power saving modes are available:

- Standby state – stops Wi-Fi until the **WAKE** pin is asserted, the time has elapsed, or activity on AT UART port is detected.
- Light sleep
- Deep sleep

toggling the **WAKE** on NORA-W2 module when module is in deep sleep mode, allows the module to enter active wake mode.

2.2.1 Module reset

NORA-W2 series modules can be reset (rebooted) in any of the following ways:

- **RESET_N** pin. Normally set high by an internal pull-up, a logical low state on this signal low causes a “reset” of the module. **RESET_PIN** should be driven by an open drain, open collector, or contact switch.
- **EXPRESSLINK_RST**. Similar reset on NORA-W2 modules can be asserted using software **AT** command.

2.3 RF antenna interface

The RF antenna interface of NORA-W2 modules supports Wi-Fi, and Bluetooth Low Energy on the same antenna. The different communication protocols are time divided on the antenna to switch between the Bluetooth and Wi-Fi data. Although communication using these different protocols is (more or less) transparent in the application, these protocols are never active at the same time in the module antenna.

NORA-W2 series modules support either an internal antenna (NORA-W256AWS) or external antennas connected through a dedicated antenna pin (NORA-W251AWS).

2.3.1 Internal antenna

NORA-W256AWS modules have internal antennas that are specifically designed and optimized for NORA modules. NORA-W256AWS module is equipped with a 2.4 GHz PCB trace antenna.

It is advisable to place the PCB trace antenna, embedded in NORA-W256AWS, in the middle and along the side edge of the host PCB.

For NORA-W256AWS designs, keep a minimum clearance of 5 mm between the antenna and the casing. Also, keep at least 10 mm of free space around the metal antenna including the area directly below it. If a metal enclosure is required, use NORA-W251AWS and an external antenna.

It is beneficial to have a large solid ground plane on the host PCB with a good grounding on the module. The minimum ground plane size is 24 x 30 mm but more than 50 x 50 mm is recommended.

For more information about antenna-related design, see also the NORA-W2 series system integration manual [1].

 The **ANT** signal solder pin is not available on the NORA-W256AWS module.

2.3.2 External RF antenna interface

The NORA-W251AWS module has an antenna signal (**ANT**) pin with a characteristic impedance of 50 Ω for use with an external antenna. The antenna signal supports both Tx and Rx.

The external antenna, for example, can be an SMD antenna (or PCB integrated antenna) on the host board. An antenna connector for using an external antenna through a coaxial cable could also be implemented. A cable antenna might be necessary if the module is mounted in a shielded enclosure such as a metal box or cabinet.

An external antenna connector (U.FL. connector) is included in the available reference design, which must be followed to comply with the NORA-W2 FCC/IC modular approvals. See also the NORA-W2 series system integration manual [1].

2.4 IO signals

2.4.1 Drive capability

All GPIO pins are normally configured for medium current consumption. Using this standard drive capability, a pin configured as output can source and an input sink a certain amount of current.

2.4.2 System status IO signals

The **RED**, **GREEN** and **BLUE** pins are used to signal the status. They are active low and are intended to be routed to an RGB LED.

Status	RGB LED color	GREEN	BLUE	RED
IDLE	TBD	-	-	-
CONNECTING*	TBD	-	-	-
CONNECTED*	TBD	-	-	-

* = LED flashes on data activity

Table 3: System status indication

2.4.3 UART

NORA-W2 modules include a UART for communication with an application host processor (AT commands, data communication, and software upgrades).

The following UART signals are available:

- Data lines (**RXD** as input, **TXD** as output)
- Frame format configuration:
 - 8 data bits
 - Even or no-parity bit
 - 1 stop bit
 - 115200 bits/s baud rate

3 Pin definition

3.1 NORA-W2 pin assignment

Figure 3 shows the pinout for NORA-W2 modules.

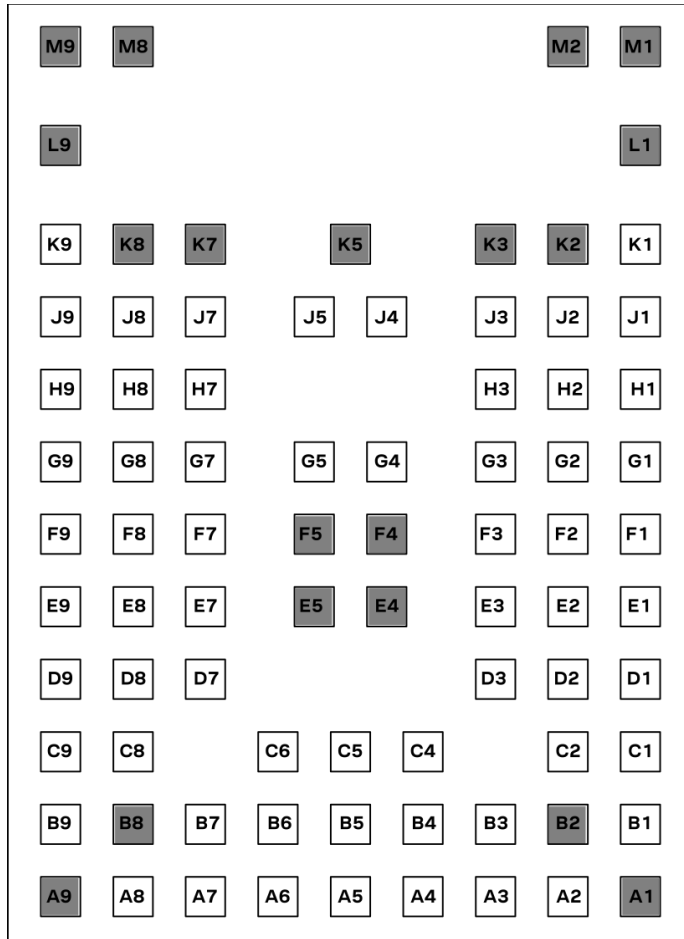

Figure 3: NORA-W251AWS/W256AWS pin assignment (top view)

All grey pins located on the module are GND pins.

3.2 Pinout

Table 4 describes the common pinout for all NORA-W2 series modules.

No.	NORA function	I/O	Description	ESP32-S3 function	Remarks
A3	EXPRESSLINK_I2C_SCL	I/O	General Purpose I/O	GPIO17	Reserved
A5	EXPRESSLINK_RST	I/O		FSPIDQS / GPIO14	
A6	EXPRESSLINK_DEBUG_TX	O	SPI2 IO7 / General Purpose I/O	FSPIIO7 / GPIO13	
A7	VCCIO	I	Module I/O level voltage input		VIO voltage supply
A8	VCC	I	Module supply voltage input		3.0-3.6 V module supply

¹ I/O notations: I=Input, O=Output, I/O=Input or Output, PU=Pull Up, PD=Pull Down, D=Default, PP=Push-Pull, OD=Open Drain, AI/AO=Analog Input/Output, NC=Not Connected

No.	NORA function	I/O	Description	ESP32-S3 function	Remarks
B1	EXPRESSLINK_SPI_SCK	I/O	SPI2 clock / General Purpose I/O	FSPICLK / GPIO36	Reserved
B3	EXPRESSLINK_SPI_SS	I/O	SPI2 Chip select / General Purpose I/O	FSPICS0 / GPIO34	Reserved
B4	EXPRESSLINK_I2C_SDA	I/O	General Purpose I/O	GPIO18	Reserved
B7	VCCIO	I	Module I/O level voltage input		VIO voltage supply.
C1	EXPRESSLINK_SPI_MISO	I/O	SPI2 Master Input Slave Output / General Purpose I/O	FSPIQ / GPIO37	Reserved
C2	EXPRESSLINK_SPI_MOSI	I/O	SPI2 Master Output Slave Input / General Purpose I/O	FSPID / GPIO35	Reserved
D8	EXPRESSLINK_SPARE1	I/O	General Purpose I/O	GPIO4	Reserved
E7	EXPRESSLINK_SPARE2	I/O	General Purpose I/O	GPIO9	Reserved
F7	BOOT	I/O	General Purpose I/O	GPIO0/ Boot	No Connect. Disabled for NORA-W2
G2	EXPRESSLINK_WAKE	I/O	General Purpose I/O	FSPIIO6 / GPIO12	
G3	EXPRESSLINK_EVENT	I/O	SPI2 IO5 / General Purpose I/O	FSPIIO5 / GPIO11	
G8	EXPRESSLINK_TXD	I/O	UART data output / General Purpose I/O	U0TXD / GPIO43	
G9	EXPRESSLINK_RXD	I/O	UART data input / General Purpose I/O	U0RXD / GPIO44	
H8	LED2	I/O	General Purpose I/O	GPIO2	Reserved
H9	LED1	I/O	General Purpose I/O	GPIO8	Reserved
J3	RESET_N	I	External system reset input.	RESET	Active low
J8	LED3	I/O	General Purpose I/O	GPIO5	Reserved
K9	ANT	I/O	Antenna Tx/Rx interface	LNA_IN	50 Ω nominal characteristic impedance, only used with NORA-W251AWS modules. NC for NORA- W256AWS
	EGP	-	Exposed Ground Pins		Exposed scattered grey pins on the module should be connected to GND
L1-M9	EAGP	-	Exposed Antenna Ground Pins		Exposed pins underneath the antenna area should be connected to GND

Table 4: NORA-W2 pinout

4 Electrical specifications

Stressing the device above one or more of the ratings listed in the [Absolute maximum ratings](#) can cause permanent damage. These are stress ratings only. Operating the module at these or at any conditions other than those specified in the [Operating conditions](#) should be avoided. Exposure to absolute maximum rating conditions for extended periods may affect device reliability.

All given application information is only advisory and does not form part of the specification.

4.1 Absolute maximum ratings

Symbol	Description	Condition	Min	Max	Unit
VCC/VCC_IO	Module supply voltage	Input DC voltage at VCC and VCC_IO pins	-0.3	3.6	V
I _{VCC_MAX} + I _{VCC_IO_MAX}	Absolute maximum power consumption			500	mA
DPV	Digital pin voltage	Input DC voltage at any digital I/O pin	-0.3	3.6	V
P_ANT	Maximum power at receiver	Input RF power at antenna pin		0	dBm
Tstr	Storage temperature		-40	+85	°C

Table 5: Absolute maximum ratings

The product is not protected against overvoltage or reversed voltages. If necessary, voltage spikes exceeding the power supply voltage specifications shown in [Table 5](#) must be limited to values within the specified boundaries using appropriate protection devices.

4.1.1 Maximum ESD ratings

Parameter	Min.	Typical	Max.	Unit	Remarks
ESD immunity			±8*	kV	Indirect discharge according to IEC 61000-4-2
ESD sensitivity, tested for all pins except ANT and RSVD pins #11, #15, #33			2.0	kV	Human body model according to JEDEC JS001

* Preliminary values tested on EVK-NINA-W1 evaluation board.

Table 6: Maximum ESD ratings

NORA-W2 series modules are Electrostatic Sensitive Devices, which means that some special precautions must be observed when handling them. See also [ESD precautions](#).

4.2 Operating conditions

Operation beyond the specified operating conditions is not recommended and extended exposure beyond them may affect device reliability.

Unless otherwise specified, all operating condition specifications are at an ambient temperature of 25 °C and at a supply voltage of 3.3 V.

4.2.1 Operating temperature range

Parameter	Min	Max	Unit
Operating temperature	-40	+85	°C

Table 7: Temperature range

4.2.2 Supply/Power pins

Symbol	Parameter	Condition	Min	Typ	Max	Unit
VCC	Input supply voltage	Ambient temperature -40 °C to +85 °C	3.00	3.30	3.60	V
VCC_IO	I/O reference voltage	Ambient temperature -40 °C to +85 °C	3.00	3.30	3.60	V

Table 8: Input characteristics of voltage supply pins

4.2.3 RESET_N pin

Figure 4 shows the conditions for VCC and RESET_N timing during start-up and reset duration. The pin characteristics are described in Table 9.

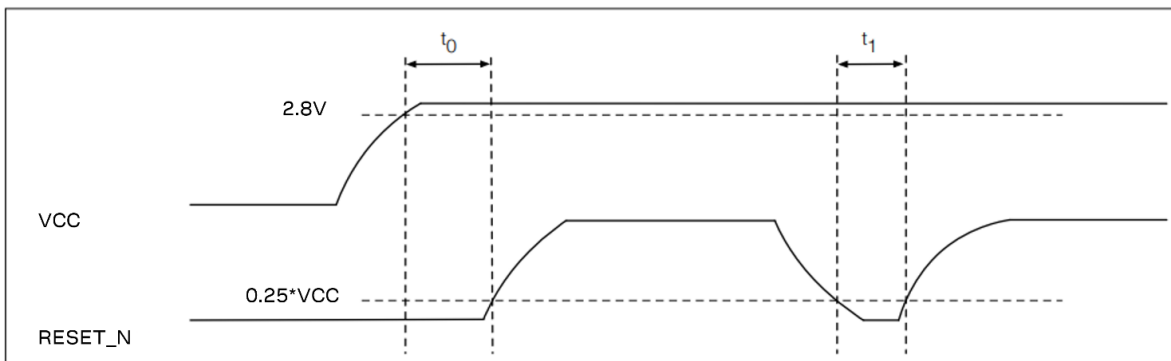

Figure 4: Module power-up and reset timing

Pin name	Parameter	Min	Typ	Max	Unit
RESET_N	Low-level input	-0.3		0.3*VCC	V
	Internal pull-up resistance		45		kΩ
	Internal capacitance		10		nF
t ₀	Time from VCC valid input level 2.8 V to RESET_N release reaches 0.25*VCC	50	1000		μs
t ₁	Duration of RESET_N pin < low level input 0.25*VCC, to trigger hardware reset	50			μs

Table 9: RESET_N pin characteristics

4.2.4 Digital pins

Pin name	Parameter	Min	Typ	Max	Unit	Remarks
Any digital pin	Input characteristic: Low-level input	0		0.3*VCC_IO	V	
	Input characteristic: high-level input	0.7*VCC_IO		VCC_IO	V	
	Output characteristic: Low-level output	0		0.4	V	
	Output characteristic: High-level output	VCC_IO-0.4		VCC_IO	V	
	Drive capability			20	mA	Source/Sink
	Pull-up/pull-down resistance			45	kΩ.	
Signals rerouted through the IO MUX	Output signal speed			20	MHz	
	Input signal speed			10	MHz	The GPIO matrix delays the input signals by two cycles of the AHB clock, which is typically around 25 ns at 80 MHz.

Table 10: Digital pin characteristics

4.2.5 Current consumption

The typical current consumption of a NORA-W2 module is shown in [Table 11](#). All measurements taken with 3.3 V supply at 25 °C.

Radio mode	Activity	Typ	Unit	Remarks
Wi-Fi	Disconnected, not connected to access point	84	mA	Current consumption for active transmission is highly dependent on the application use case
	Connected to access point, no data transmission	42	mA	
Deep-sleep mode	RTC memory and RTC peripherals are powered on	8	μA	
Reset		33	μA	

Table 11: Current consumption during typical use cases

4.2.6 Wi-Fi radio characteristics

$V_{CC} = 3.3 \text{ V}$, $T_{amb} = 25 \text{ °C}$

Parameter	Operating mode	Specification	Unit
RF Frequency Range	802.11b/g/n	2.400 – 2.484	GHz
Modulation	802.11b	CCK and DSSS	
	802.11g/n	OFDM	
Supported Data Rates	802.11b	1, 2, 5.5, 11	Mbit/s
	802.11g	6, 9, 12, 18, 24, 36, 48, 54	Mbit/s
	802.11n	MCS0 – MCS7	
Supported Bandwidth	802.11n	20,40	MHz
Supported Guard Interval	802.11n	400, 800	ns

Table 12: Wi-Fi radio characteristics

[Table 13](#) shows the maximum (conducted) transmitter output power and receiver sensitivity for supported modes of operation.

Parameter	Operating mode	Data rate	Specification (dBm)	Bandwidth	802.11 EVM Limit (dBm)
Conducted Transmit Power	802.11b	1 Mbit/s	20 ± 1	20 MHz	-21 dBm
		11 Mbit/s	20 ± 1		-21 dBm
	802.11g	6 Mbit/s	19 ± 1	20 MHz	-20 dBm
		54 Mbit/s	16 ± 1		-26.5 dBm
	802.11n	MCS0	19 ± 1	20 MHz	-21.5 dBm
			16 ± 1		-28.5 dBm
		MCS7	19 ± 1	40 MHz	-23.5 dBm
			16 ± 1		-28.5 dBm

Parameter	Operating mode	Data rate	Specification (dBm)	Bandwidth	802.11 EVM Limit (dBm)	
Receiver Sensitivity	802.11b	1 Mbit/s	-97.5 ± 2	20 MHz	N/A	
		11 Mbit/s	-88.5 ± 2		N/A	
	802.11g	6 Mbit/s	-93 ± 2	20 MHz	N/A	
		54 Mbit/s	-76 ± 2		N/A	
	802.11n	MCS0		-92.5 ± 2	20 MHz	N/A
				-74 ± 2		N/A
		MCS7		-90 ± 2	40 MHz	N/A
				-71 ± 2		N/A

* There is lower output power on band edge channels.

Table 13: Wi-Fi radio maximum transmitter and receiver power parameter

Maximum transmitter output power values are only supported in certain regions, depending upon the certification approval. See also [Radio performance](#).

4.2.7 Bluetooth Low Energy characteristics

$V_{CC} = 3.3\text{ V}$, $T_{amb} = 25\text{ °C}$

Parameter	Specification	Unit
RF Frequency Range	2.400 – 2.4835	GHz
Supported Modes	Bluetooth v5.0	
Number of channels	40	
Modulation	GFSK	
Transmit Power (typical)	$20^* \pm 1$	dBm
Receiver Sensitivity (typical)	-98 ± 2	dBm

* The maximum output power varies depending upon the region of operation.

Table 14: Bluetooth Low Energy characteristics

4.2.8 Antenna radiation patterns

Figure 4 provides an overview of the measurement procedure and describes how the NORA-W256AWS module is aligned to the XYZ-coordinate system. A measurement is taken at every dotted position above the module image (shown left). Each measurement is represented as a grid point in the radiation pattern (shown right).

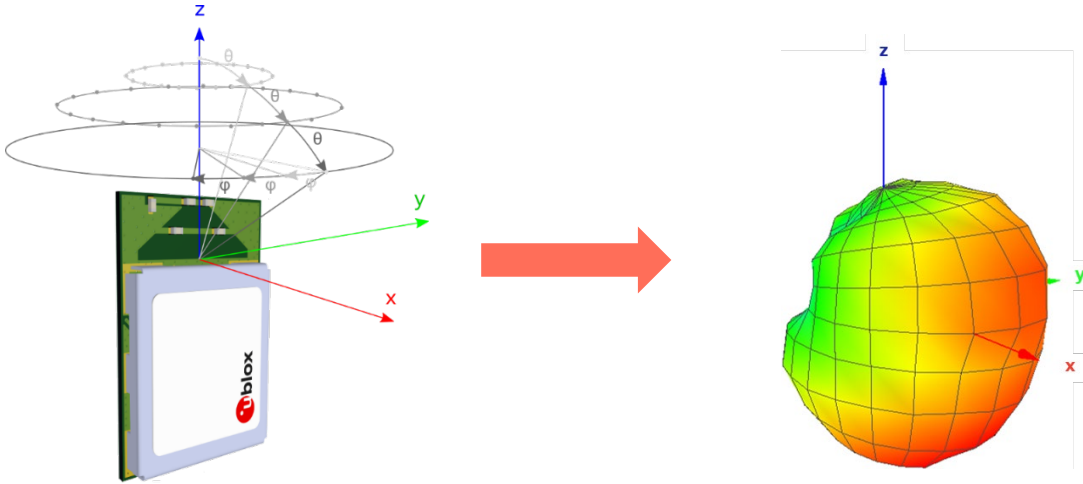
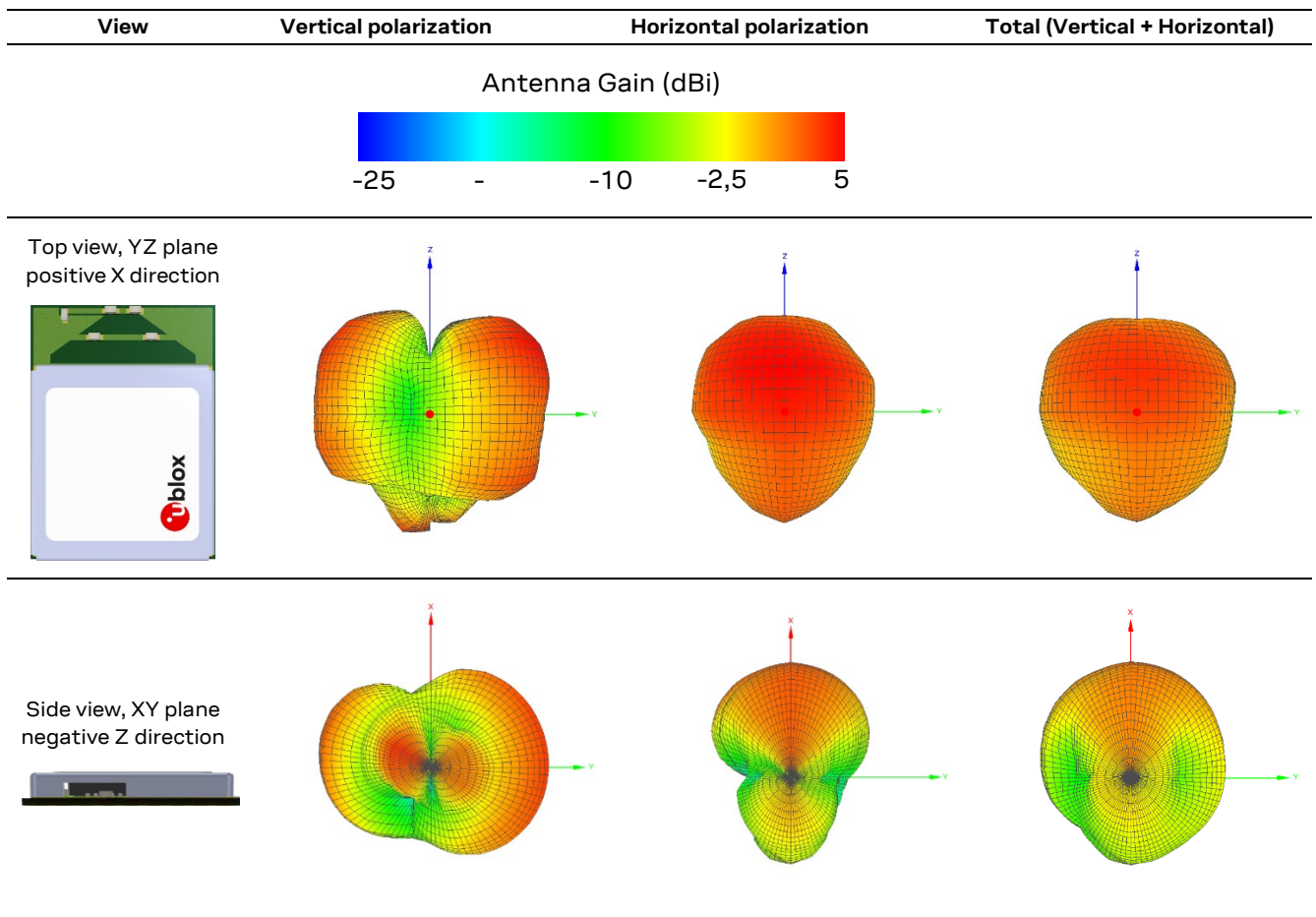

Figure 5: Measurement procedure for radiation patterns

Table 15 shows the displayed radiation patterns of the internal PCB trace antenna on NORA-W256AWS.



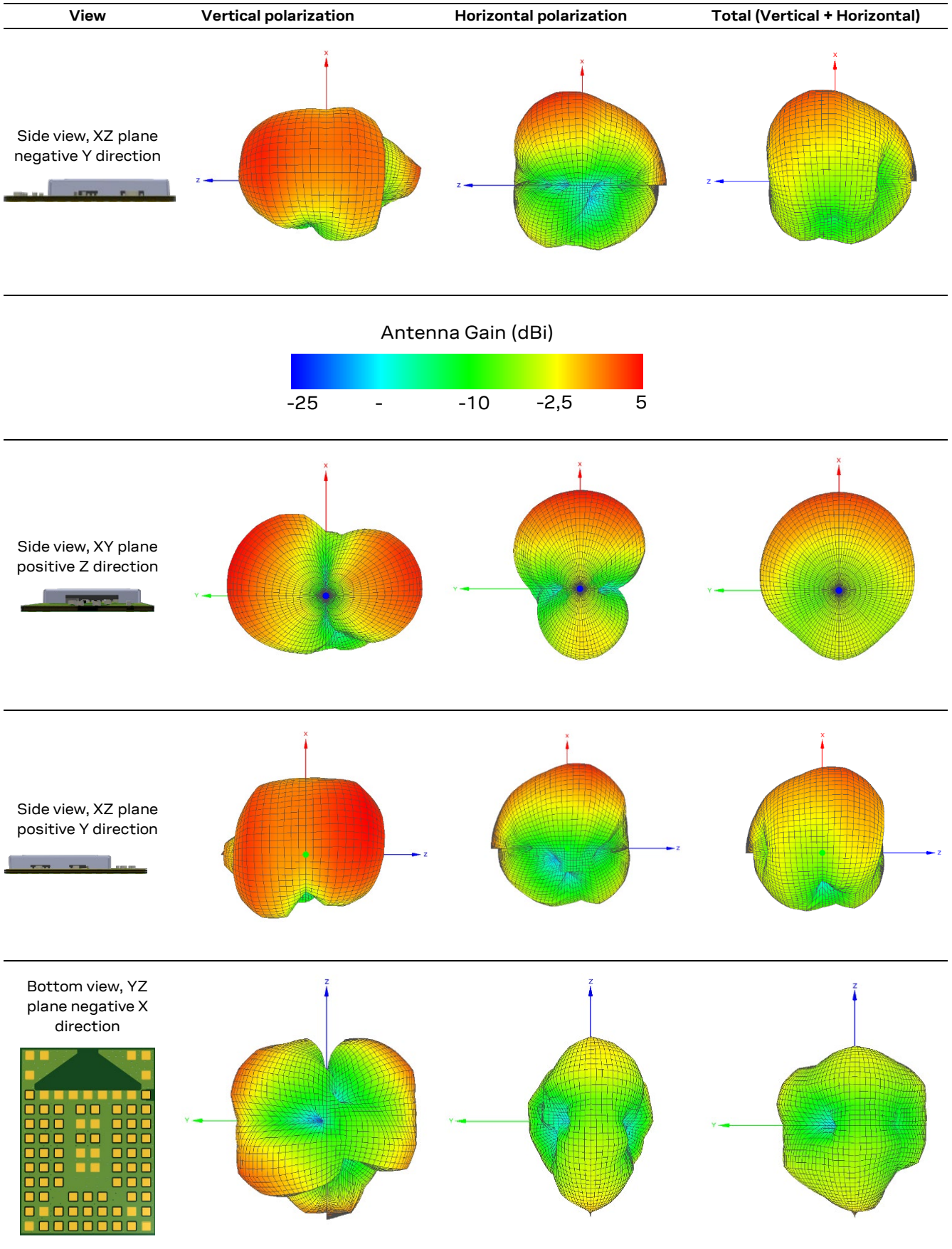

Table 15: NORA-W256AWS antenna radiation patterns

5 Mechanical specifications

5.1 NORA-W256AWS mechanical specifications

Figure 6 shows the critical dimensions of the NORA-W256AWS package.

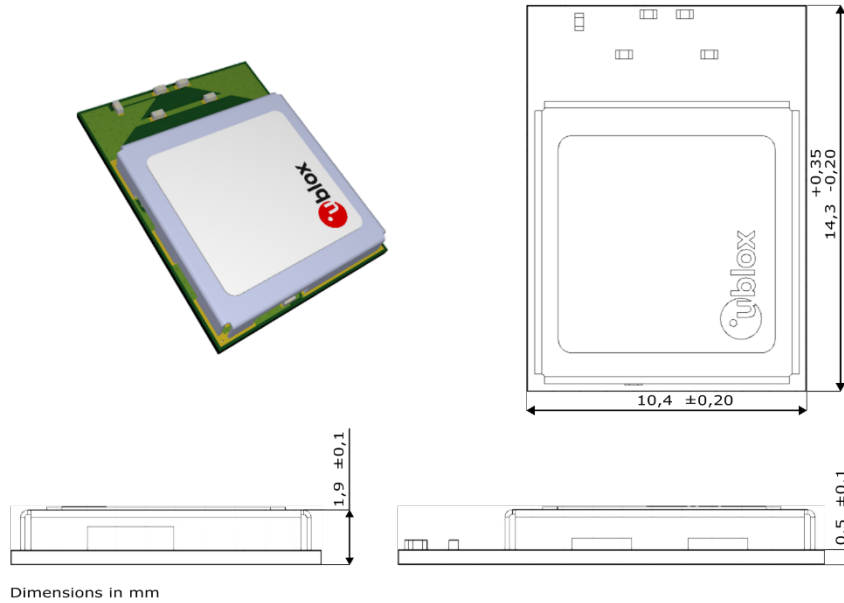

Figure 6: NORA-W256AWS dimensions

5.2 NORA-W251AWS mechanical specifications

Figure 7 shows the critical dimensions of the NORA-W251AWS package.

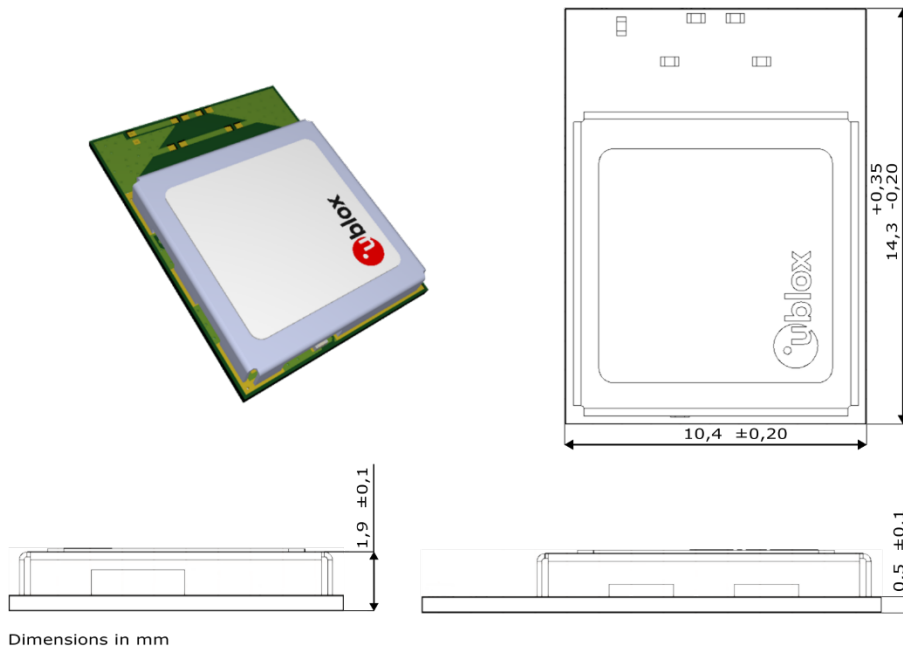

Figure 7: NORA-W251AWS dimensions

Figure 8 shows the mechanical outline of NORA-W2 modules.

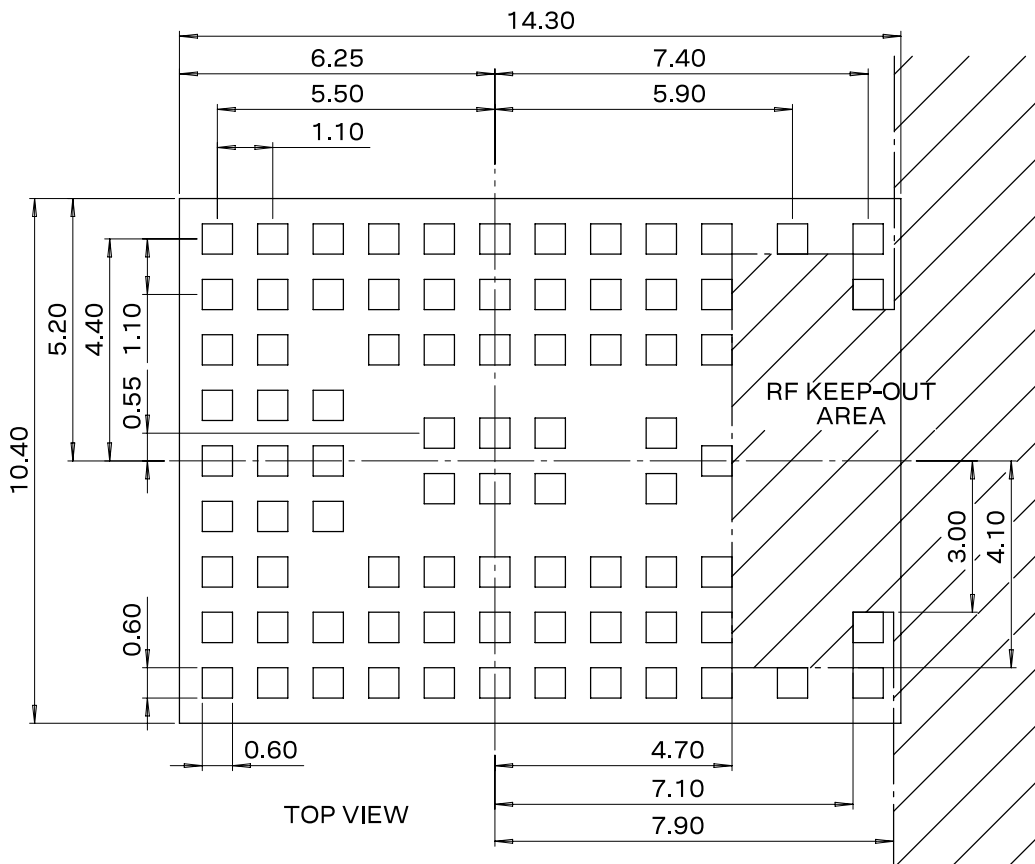



Figure 8: NORA-W2 mechanical outline

6 Qualification and approvals

6.1 Country approvals

NORA-W2 modules are certified for use in the following countries/regions:

Country/region	NORA-W251AWS	NORA-W256AWS
Europe	Approved	Approved
UKCA	Approved	Approved
USA	Approved	Approved
Canada	Approved	Approved
Japan	Approved	Approved
Taiwan	Pending	Pending
South Korea	Approved	Approved
Brazil	Approved	Approved
Australia	Approved	Approved
New Zealand	Approved	Approved
South Africa	Pending	Pending

 For detailed information about the regulatory requirements that must be met when using NORA-W2 modules in an end product, see the system integration manual [1].

6.2 Bluetooth qualification



End products must be qualified and listed with the [Bluetooth Special Interest Group \(SIG\)](#). Product declarations are submitted through the [Bluetooth Launch Studio website](#).

NORA-W25 modules are qualified as a Controller Subsystem in accordance with the Bluetooth 5.0 specification and are registered with the SIG Qualified Design IDs (QDID) shown in [Table 16](#).

To list your product that integrates NORA-W251AWS or NORA-W256AWS with no additional testing required, combine the QDID for the Bluetooth stack implemented in the Host Subsystem with the QDID of the pre-qualified Controller Subsystem, as shown in [Table 16](#).

Model	Product type	QDID	Listing date
NORA-W251AWS, NORA-W256AWS	Controller Subsystem	198070	14-Nov-2022
NORA-W251AWS, NORA-W256AWS	Host Subsystem	141499	8-Nov-2019

Table 16: NORA-W2 series Bluetooth qualified design ID

7 Product handling

7.1 Packaging

NORA-W2 modules are delivered as hermetically sealed, reeled tapes that enable efficient production, production lot set-up, and tear-down. For more information about packaging, see also the Packaging information reference [2].

⚠ NORA-W2 series modules are in functional sample status, as described in the [Document information](#). Consequently, the information is valid and available only after the module is fully tested and approved during the Initial Production stage.

7.1.1 Reels

NORA-W2 series modules are deliverable in quantities of 500 pieces on a reel. [Table 18](#) describes the reel types for each module variant.

Model	Reel type
NORA-W251AWS	A3
NORA-W256AWS	A3

Table 17: Reel types for different NORA-W2 series modules

For further information about the reel types, see also the Packaging information reference [2].

7.1.2 Tapes

[Figure 10](#) shows the position and orientation of NORA-W2 series modules as they are delivered on tape.



Figure 9: NORA-W251 module on tape orientation



Figure 10: NORA-W256 module on tape orientation

Figure 11 shows the tape and pocket dimensions of the module.

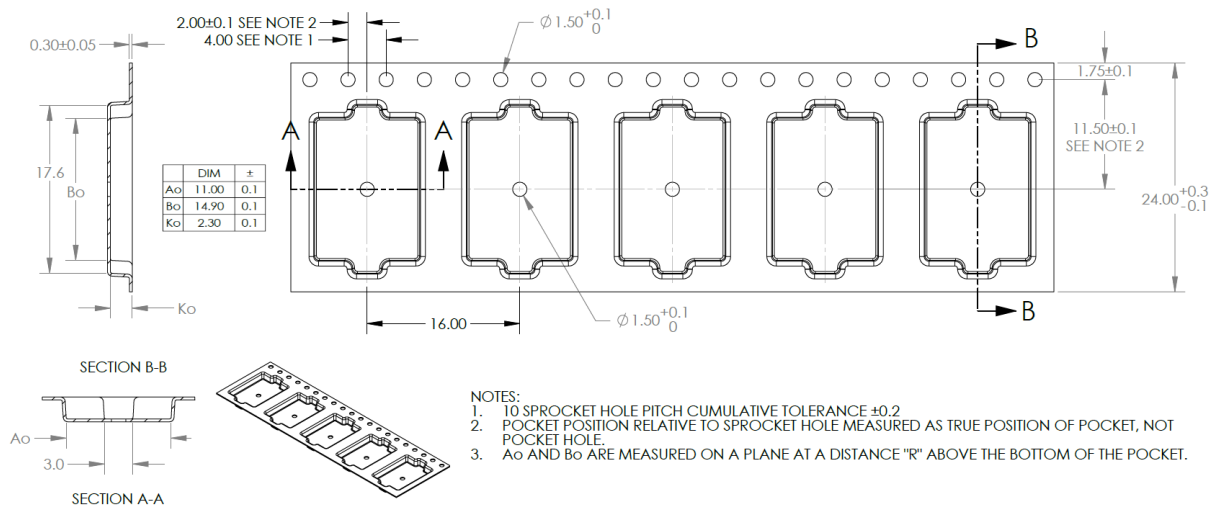

Figure 11: NORA-W2 tape dimensions

7.2 Moisture sensitivity levels

- ⚠ The NORA-W2 series modules are Moisture Sensitive Devices (MSD) in accordance with the IPC/JEDEC specification.

The Moisture Sensitivity Level (MSL) relates to the required packaging and handling precautions. The NORA-W2 series modules are rated at MSL level 4. For more information regarding moisture sensitivity levels, labeling, and storage, see the u-blox package information guide [2].

- 📖 For MSL standards, see IPC/JEDEC J-STD-020, which can be downloaded from www.jedec.org.

7.3 Reflow soldering

Reflow soldering profiles must be selected in accordance with u-blox soldering recommendations described in the NORA-W2 system integration manual [1].

- ⚠ Failure to observe these recommendations can result in severe damage to the product.

7.4 ESD precautions

- ⚠ NORA-W2 series modules are Electrostatic Sensitive Devices that demand the observance of special handling precautions against static damage. Failure to observe these precautions can result in severe damage to the product. See also [Maximum ESD ratings](#).

Proper ESD handling and packaging procedures must be applied throughout the processing, handling, and operation of any application that incorporates the NORA-W2 series module. ESD precautions are particularly relevant when handling the application board on which the module is mounted.

For further information about the handling of NORA-W2 series modules, see also the NORA-W2 system integration manual [1].

8 Labeling and ordering information

8.1 Product labeling

The labels (8 x 8 mm) on NORA-W2 series modules include important product information.

Figure 12 shows the label attached to all the NORA-W2 series modules, which includes product type number and revision, production date, and data matrix that bears a unique serial number and the u-blox logo. Each of the given label references are given in millimeters [mm].

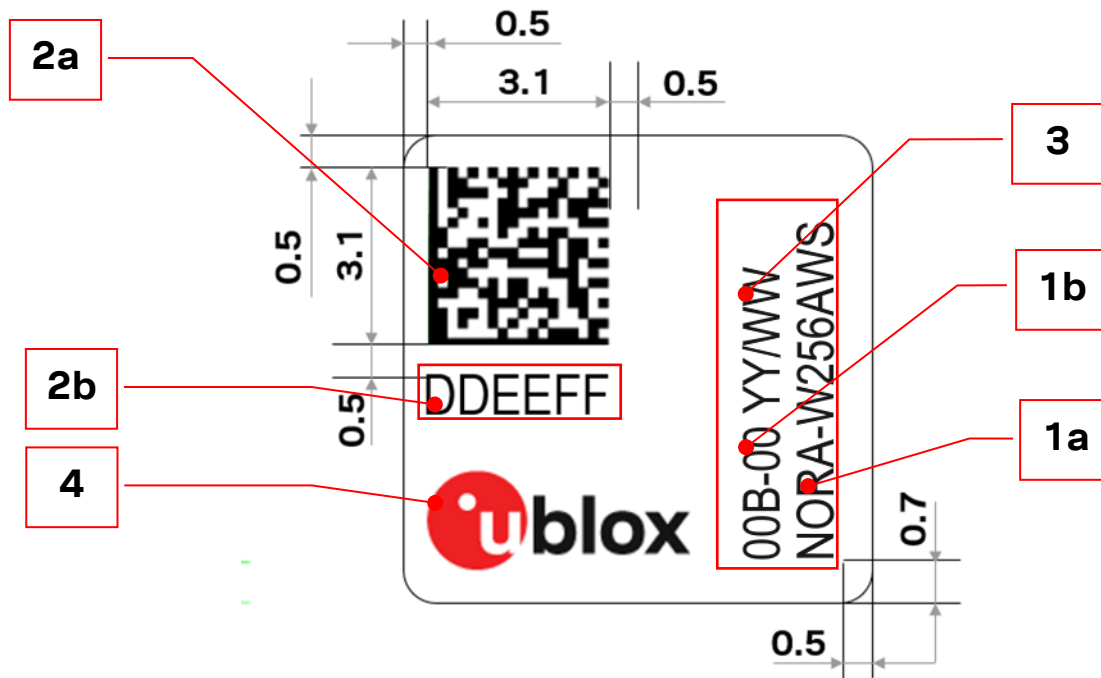

Figure 12: Location of product type number on the NORA-W2 series module label

Reference	Description
1a	Text box containing Product Name and approval ID:s (Applicable model names: NORA-W2xx).
1b	Product type number
2a	Data Matrix with unique serial number comprising 19 alphanumeric digits: (product identifier, serial number, datacode) <ul style="list-style-type: none"> Product identifier: 3 digits, used for production tracking and are an abbreviated representation of the Type number that is unique to each module variant Serial number: 12 digits, Unique MAC address assigned during module production. Datacode: 4 digits, Represent the hardware and firmware version encoded.
2b	The six last hex symbols of the MAC address (AABBCCDDEEFF).
3	Date of production encoded YY/WW (year/week).
4	u-blox logo with the red dot to indicates pin 1.

Table 18: NORA-W2 series label description

8.2 Product identifiers

Table 19 describes the three product identifiers, namely the Type number, Model name and Ordering code.

Format	Description	Nomenclature
Model name	Describes the form factor, platform technology and platform variant. Used mostly in product documentation like this data sheet, the model name represents the most common identity for all u-blox products	PPPP-TGVV
Ordering code	Comprises the model name – with additional identifiers to describe the major product version and quality grade	PPPP-TGVV-TTQ
Type number	Comprises the model name and ordering code – with additional identifiers to describe minor product versions.	PPPP -TGVV-TTQ-XX

Table 19: Product code formats

8.3 Identification codes

Table 20 describes the individual identification codes represented in each product identifier.

Code	Meaning	Example
PPPP	Form factor	NORA
TG	Platform (Technology and Generation) T – Dominant technology, For example, W: Wi-Fi, B: Bluetooth G – Generation	W2: Wi-Fi Generation 2
VV	Variant based on the same platform; range [00...99]	01: product with antenna pin
TT	Major Product Version	00: first revision
Q	Quality grade A: Automotive B: Professional C: Standard	B: professional grade
XX	Minor product version (not relevant for certification)	Default value is 00

Table 20: Part identification code

8.4 Ordering information

Ordering code	Product
NORA-W251AWS-00B	Wi-Fi IEEE802.11 b/g/n module with antenna pin. Includes AWS IoT ExpressLink software with secure boot
NORA-W256AWS-00B	Wi-Fi IEEE802.11 b/g/n module with internal PCB trace antenna. Includes AWS IoT ExpressLink software with secure boot

Table 21: Product ordering codes

Appendix

A Glossary

Abbreviation	Definition
ADC	Analog to Digital Converter
AWS	Amazon Web Services
BLE	Bluetooth low energy
BPF	Band Pass Filter
CAN	Controller Area Network
CTS	Clear To Send
DAC	Digital to Analog Converter
DC	Direct Current
D/C	Don't Care
DSR	Data Set Ready
ESD	Electro Static Discharge
FCC	Federal Communications Commission
GATT	Generic ATtribute profile
GND	Ground
GPIO	General Purpose Input/Output
I2C	Inter-Integrated Circuit
IC	Industry Canada
IEEE	Institute of Electrical and Electronics Engineers
IoT	Internet of Things
LPO	Low Power Oscillator
MCU	Micro Controller Unit
MDIO	Management Data Input / Output
MII	Media-Independent Interface
MIMO	Multi-Input Multi-Output
MRD	Market Requirement Document
MSD	Moisture Sensitive Device
N/A	Not Applicable
PCN	Product Change Notification
PIFA	Planar Inverted IF Antenna
QSPI	Quad Serial Peripheral Interface
RMII	Reduced Media Independent Interface
RTS	Request To Send
RXD	Receive Data
SDIO	Secure Digital Input Output
SDK	Software Development Kit
SPI	Serial Peripheral Interface
TBD	To Be Defined
TXD	Transmit Data
UART	Universal Asynchronous Receiver/Transmitter

Table 22: Explanation of the abbreviations and terms used

Related documents

- [1] NORA-W2 series system integration manual, [UBX-22005177](#)
- [2] Packaging information reference, [UBX-14001652](#)
- [3] NORA-W2 declaration of conformity, TBD
- [4] NORA-W2 series product summary, [UBX-21044252](#)
- [5] NORA-B1 data sheet, [UBX-20027119](#)
- [6] AWS IoT ExpressLink developer page, <https://docs.aws.amazon.com/expresslink>

 For product change notifications and regular updates of u-blox documentation, register on our website, www.u-blox.com.

Revision history

Revision	Date	Name	Comments
R01	19-Nov-2021	asoh	Initial release of the data sheet for NORA-W2 series modules with open CPU architecture.
R02	15-Jul-2022	asoh	Added boot pin mapping, assigned boot pin to NC and LED3 function to the GPIO5 pin, and included other significant changes in the module Pinout . Clarified currently support for 3.3 V IO voltage level only in section Digital I/O interfaces reference voltage .
R03	31-Mar-2023	asoh, hekf	Revised product status in Document information . Revised typical values for conducted power, radiated power, and conducted sensitivity in Radio performance . Added table data and timing diagram for RESET_N pin . Revised power modes in System functions . Revised table data in Pinout , Current consumption and Wi-Fi radio characteristics . Revised typical values for transmit power and receiver sensitivity in Bluetooth Low Energy characteristics . Added UKCA certification and revised status in Country approvals , NORA-W2 IEEE 802.11d implementation description , and other related references. Revised typical values for transmit power and receiver sensitivity in Bluetooth Low Energy characteristics and included QD ID data in Bluetooth qualification .
R04	19-Dec-2023	hekf	Updated Country approvals and Bluetooth qualification .

Contact

u-blox AG

Address: Zürcherstrasse 68
8800 Thalwil
Switzerland

For further support and contact information, visit us at www.u-blox.com/support.

X-ON Electronics

Largest Supplier of Electrical and Electronic Components

Click to view similar products for [Multiprotocol Modules](#) category:

Click to view products by [U-Blox](#) manufacturer:

Other Similar products are found below :

[9260.NGWG.NV 958867](#) [AX210.NGWG.NV](#) [BM833](#) [ESP32-C3-MINI-1U-H4](#) [ESP32-WROOM-32U-16MB](#) [ESP32-WROOM-32UE](#)
[ESP32-WROOM-32D-H4](#) [ESP32-WROOM-32U-H4](#) [ESP32-PICO-MINI-02U-N8R2](#) [ESP32-C6-WROOM-1-N4](#) [ESP32-C6-WROOM-1U-N4](#)
[ESP32-C6-WROOM-1-N8](#) [BE200.NGWG.NV](#) [BE200.NGWG](#) [BE202.NGWG.NV](#) [BE200.NGWG.NVX](#) [AX411.NGWG.NV](#) [AX210.D2WG](#)
[AX210.NGWG.NVX](#) [AX211.NGWG](#) [EC200UEUAA-N05-TA0AA](#) [SC20ELSATEA-8GB-UGAD](#) [SG560DEUPA-U61-TA0AA](#)
[AX211.NGWG.NV](#) [ISM43340-M4G-L44-10CF-C6.2.1.11](#) [KG100SABMD](#) [BC40P](#) [S007-PIN254](#) [S007-PIN127](#) [ESP32-C3-12F](#)
[FC41DAHMD](#) [EWM-W179M201E](#) [ESP32-C6-WROOM-1U-N8](#) [ATWILC3000-MR110CA](#) [RS9113-NBZ-D5W](#) [ATWINC3400-](#)
[MR210UA122](#) [ESP32-WROOM-32](#) [AMPAK AP12356 WIFI/BT KIT](#) [AIW-154BN](#) [AIW-165BN](#) [AIW-166K1](#) [AIW-166K2](#) [AIW-166K3](#)
[AIW-166K4](#) [AIW-355 DQ-N01](#) [AIW-355 DQ-C01](#) [EWM-W159M201E](#) [EWM-W192K1](#) [EWM-W192K2](#) [W106C](#)