

NORA-W30 series

Stand-alone dual-band Wi-Fi and Bluetooth modules

Data sheet

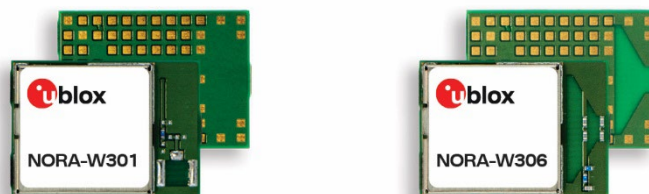

Abstract

Aimed towards developers and other technical staff, this document provides important information necessary for the design of customer applications based on the module. It includes an overview and comprehensive functional description of each NORA-W30 module variant – together with a detailed pin list, block diagram, mechanical and electrical specification, application development information, and more.

Document information

Title	NORA-W30 series	
Subtitle	Stand-alone dual-band Wi-Fi and Bluetooth modules	
Document type	Data sheet	
Document number	UBX-22021117	
Revision and date	R05	26-Apr-2024
Disclosure restriction	C1-Public	

Product status	Corresponding content status	
Functional sample	Draft	For functional testing. Revised and supplementary data will be published later.
In development / Prototype	Objective specification	Target values. Revised and supplementary data will be published later.
Engineering sample	Advance information	Data based on early testing. Revised and supplementary data will be published later.
Initial production	Early production information	Data from product verification. Revised and supplementary data may be published later.
Mass production / End of life	Production information	Document contains the final product specification.

This document applies to the following products:

Product name	Type number	IN/PCN reference	Product status
NORA-W301	NORA-W301-00B-00	N/A	Initial production
NORA-W306	NORA-W306-00B-00	N/A	Initial production

u-blox or third parties may hold intellectual property rights in the products, names, logos, and designs included in this document. Copying, reproduction, or modification of this document or any part thereof is only permitted with the express written permission of u-blox. Disclosure to third parties is permitted for clearly public documents only.

The information contained herein is provided "as is" and u-blox assumes no liability for its use. No warranty, either express or implied, is given, including but not limited to, with respect to the accuracy, correctness, reliability, and fitness for a particular purpose of the information. This document may be revised by u-blox at any time without notice. For the most recent documents, visit www.u-blox.com.

Copyright © u-blox AG.

Contents

Document information	2
Contents	3
1 Functional description	6
1.1 Overview.....	6
1.2 Applications	6
1.3 Block diagram	7
1.4 Product variants.....	7
1.4.1 NORA-W301	7
1.4.2 NORA-W306	7
1.5 Radio performance	8
1.6 CPU.....	8
1.6.1 Open CPU software	9
1.6.2 Software upgrade	9
1.7 MAC addresses	9
1.8 Power modes.....	9
2 Interfaces	10
2.1 Power supply	10
2.2 Low power clock	10
2.3 Module reset	10
2.4 Bootstrap pins	10
2.5 RF antenna interface.....	10
2.5.1 Internal antenna.....	10
2.5.2 External RF antenna interface.....	11
2.6 IO signals.....	11
2.6.1 PWM timer	11
2.7 Data interfaces.....	11
2.7.1 USI.....	11
2.7.2 I2C	11
2.7.3 I2S	12
2.7.4 IR.....	12
2.7.5 Key-scan	12
2.7.6 Q-decoder	12
2.7.7 RTC	12
2.7.8 SDIO.....	12
2.7.9 SPI.....	13
2.7.10 SPI Flash	13
2.7.11 UART	13
2.7.12 USB	13
2.7.13 Wake sources	13
2.8 Analog interfaces	14

- 2.8.1 ADC 14
- 2.9 Debug interface 14
 - 2.9.1 SWD 14
- 3 Pin definition 15**
- 3.1 NORA-W3 pin definition 15
 - 3.1.1 NORA-W30 open CPU pin assignments 15
- 4 Electrical specifications 20**
- 4.1 Absolute maximum ratings 20
 - 4.1.1 ESD characteristics 20
- 4.2 Recommended operating conditions 20
 - 4.2.1 Operating temperature 20
 - 4.2.2 Supply / power pins 20
 - 4.2.3 I2C pull-up resistor values 21
 - 4.2.4 nRESET pin 21
 - 4.2.5 Low frequency clock 21
 - 4.2.6 Digital pins 21
 - 4.2.7 Current consumption 21
 - 4.2.8 Wi-Fi radio characteristics 22
 - 4.2.9 Bluetooth LE characteristics 23
 - 4.2.10 Antenna radiation patterns 24
- 5 Mechanical specifications 26**
- 5.1 NORA-W30 footprint dimensions 26
- 5.2 NORA-W30 mechanical specifications 27
 - 5.2.1 NORA-W301 mechanical specifications 27
 - 5.2.2 NORA-W306 mechanical specifications 27
- 6 Qualifications and approvals 28**
- 6.1 Country approvals 28
- 6.2 Bluetooth qualification 28
- 6.3 Environmental 28
 - 6.3.1 RoHS 28
 - 6.3.2 REACH 28
- 6.4 Antennas 29
- 7 Product handling 30**
- 7.1 Packaging 30
 - 7.1.1 Reels 30
 - 7.1.2 Tapes 30
- 7.2 Moisture sensitivity levels 31
- 7.3 Reflow soldering 31
- 7.4 ESD precautions 32
- 8 Labeling and ordering information 33**
- 8.1 Product labeling 33
- 8.2 Ordering information 33

Appendix	34
A Glossary	34
Related documentation	35
Revision history	35
Contact.....	35

1 Functional description

1.1 Overview

NORA-W3 series are small, stand-alone, dual-band Wi-Fi™ and Bluetooth® Low Energy microcontroller unit (MCU) modules. The modules are perfect for integrating wireless connectivity into end products.

With Wi-Fi 4 (IEEE 802.11a/b/g/n) in the 2.4 and 5 GHz bands it can be a Wi-Fi station connecting to a remote access point or act as an access point. NORA-W30 is Bluetooth 5.3 qualified and can assume peripheral or central roles, or both simultaneously. It can be a GATT client or server.

The module embeds a dual-core MCU, with a powerful Arm® Cortex®-M33 compatible processor for the main application and an Arm Cortex-M23 compatible processor for low power operation.

The NORA-W30 series includes hardware security features like secure boot, trusted execution environment with Arm TrustZone®, encrypted flash, protection of debug port, and a crypto acceleration engine. The wireless communication can be secured with WPA2/WPA3 authentication, TLS 1.2/1.3 encryption, Bluetooth LE secure connection pairing, and HTTPS.

The modules are suitable for a wide range of applications, including industrial automation, smart cities, smart buildings and homes, metering and utilities, healthcare, and EV charging.

NORA-W306 comes with an internal PCB antenna while NORA-W301 has a module pin to connect to an external antenna of choice. The internal PCB antenna provides a robust low-profile solution with high performance and an extensive range. The NORA-W30 series is globally certified for use with the internal antenna or a range of external antennas, which reduces time, cost and effort for customers integrating Wi-Fi and Bluetooth low energy in their designs.

NORA-W30 modules have the same physical dimensions as other NORA modules and have critical pins and interfaces at the same positions. This offers maximum flexibility for the development of similar end-devices with different radio technologies. The modules support operation in an extended temperature range of -40°C to +105°C and are qualified for professional grade applications.

 Approval for NORA-W30 is currently pending in some countries. See also [Country approvals](#).

1.2 Applications

NORA-W30 series are suitable for a wide range of applications, including:

- Wi-Fi networks
- Internet of Things (IoT)
- Bluetooth Low Energy applications
- Metering and utilities
- Point-of-sales
- Healthcare
- Access to laptops, mobile phones, and similar consumer devices
- Smart buildings and homes
- EV charging

1.3 Block diagram

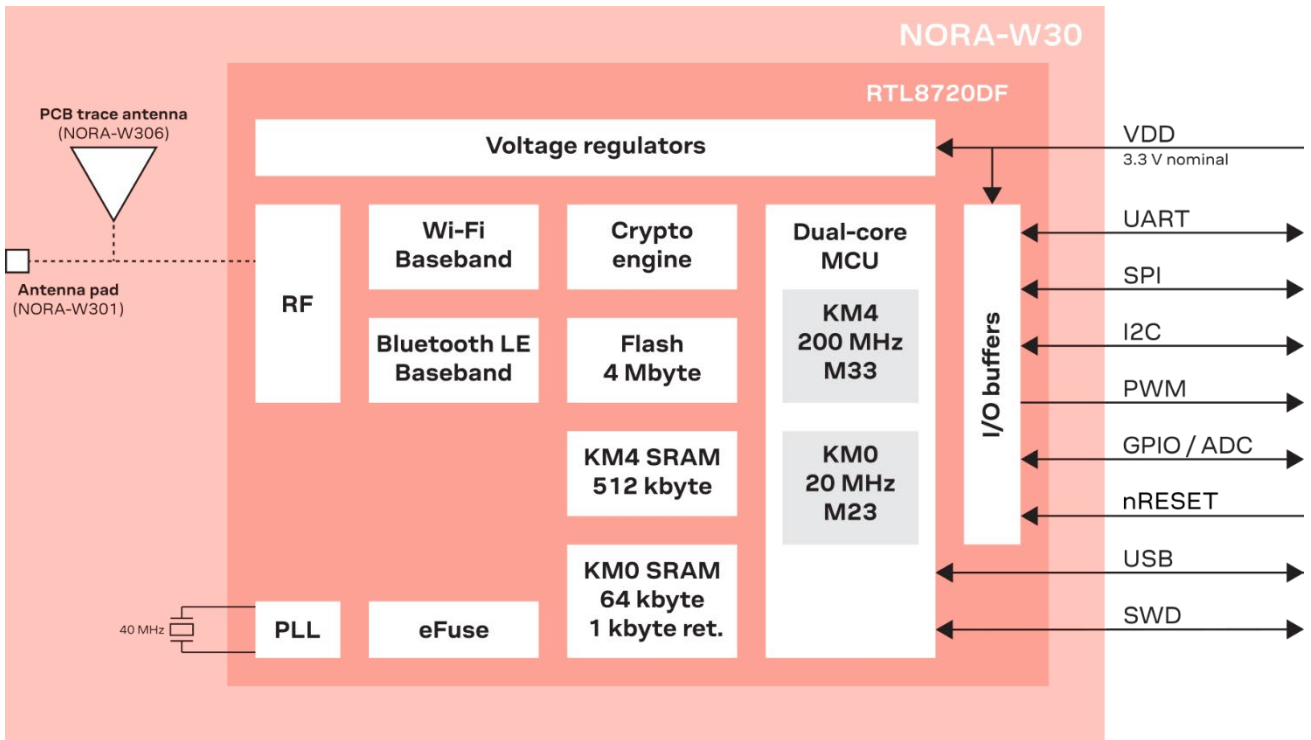

Figure 1: NORA-W30 series block diagram

1.4 Product variants

NORA-W30 modules have an open CPU architecture that is tailored towards OEMs that want to embed Wi-Fi 802.11a/b/g/n and Bluetooth Low Energy 5.3 in the 2.4 GHz ISM band into their own application. NORA-W30 product variants share the same pin-out, footprint, and size of 14.3 mm x 10.4 mm x 1.9 mm.

1.4.1 NORA-W301

NORA-W301 has no internal antenna. The RF signal for routing to an external antenna or antenna connector signal is exposed through a dedicated module pin.

1.4.2 NORA-W306

NORA-W306 is equipped with an internal PCB trace antenna, using antenna technology licensed from Abracon. The RF signal is not connected to any module pin.

1.5 Radio performance

The radio provides support for Wi-Fi 4, IEEE 802.11a/b/g/n in the 2.4 GHz and 5 GHz ISM bands and Bluetooth LE communication in the 2.4 GHz ISM band, as shown in [Table 1](#).

Wi-Fi	Bluetooth Low Energy
IEEE 802.11a/b/g/n	Bluetooth LE 5.3
Band support Station mode: 2.4 GHz, channels 1-13*, (14 Japan only)** 5 GHz, channels 36-165*	Band support 2.4 GHz, 40 channels
Access Point mode: 2.4 GHz, channels 1-13*, (14 Japan only)* 5 GHz, channels 36-48, 149-165*	
Typical conducted output power: 2.4 GHz, 20 dBm 5 GHz, 18 dBm	Typical conducted output power 8 dBm (NORA-W306) 6.5 dBm (NORA-W301)
Typical radiated output power: 2.4 GHz, 25.3 dBm EIRP** 5 GHz, 23.3 dBm EIRP**	Typical radiated output power 11.8 dBm EIRP**
Conducted sensitivity 802.11b, -98 dBm (1 Mbps) 802.11g, -95 dBm (6 Mbps) 802.11a, -93 dBm (6 Mbps) 802.11n, -95 dBm (2.4GHz, MCS 0) 802.11n, -93 dBm (5GHz, MCS 0)	Conducted sensitivity LE1M, -101 dBm LE2M, -97 dBm
Data rates: IEEE 802.11a: 6 / 9 / 12 / 18 / 24 / 36 / 48 / 54 Mbps IEEE 802.11b: 1 / 2 / 5.5 / 11 Mbps IEEE 802.11g: 6 / 9 / 12 / 18 / 24 / 36 / 48 / 54 Mbps IEEE 802.11n: MCS 0-7, HT20 (6.5-150 Mbps), HT40	Data rates: 1 / 2 Mbps

* Maximum support depends on the region.

** RF power including maximum antenna gain (2.4GHz – 5.3 dBi, 5GHz – 5.3 dBi).

Table 1: NORA-W30 series Wi-Fi and Bluetooth characteristics

1.6 CPU

NORA-W30 embeds a dual-core MCU, with a powerful Arm Cortex-M33 compatible processor running at 200 MHz for the main application and an Arm Cortex-M23 compatible processor running at 20 MHz for low power operation.

The main features of the internal NORA-W30 memory include:

- 4 Mbyte flash for applications
- 512 kbyte RAM for the main core
- 64 kbyte RAM for the low power core
- Arm TrustZone hardware encryption to protect programs.

1.6.1 Open CPU software

NORA-W30 series modules are not supplied with any application software but include an open-CPU architecture that allows customers to develop advanced applications running on the dual core 32-bit MCU.

NORA-W30 series modules can be used to design solutions with top-grade security. Including integrated cryptographic hardware accelerators, the modules feature secure boot functionality that ensures that the module can only be restarted with authenticated software.

1.6.2 Software upgrade

A bootloader is included in ROM. When upgrading the module firmware, see also the NORA-W30 system integration manual [1].

1.7 MAC addresses

NORA-W30 series modules are assigned a block of four MAC addresses. The lowest number is encoded in the 2D data matrix printed on the label. The remaining are intended to be calculated by the application according to Table 2.

MAC address	Assignment	Remarks
Base address	Wi-Fi station	Printed on label data matrix. See Product labeling .
Base address + 1	Wi-Fi access point	Calculated by application
Base address + 2	Bluetooth LE device address	Calculated by application
Base address + 3	Unused	

Table 2: MAC addresses

1.8 Power modes

NORA-W30 series modules are power efficient devices capable of operating in different power saving modes and configurations. Different sections of the module can be powered off when they are not needed, and complex wake up events can be generated from different external and internal inputs.

NORA-W30 series have three power modes: active, sleep, and deep-sleep as noted in [2].

Power mode	Description	Conditions
Active	Normal operation	
Sleep	Processor clock idle System clock running	All SRAM retained Interrupts on All I/O retained
Deep-sleep	System clock halted PLL switched off Flash memory switched off	1 kbyte SRAM retained Interrupts off 7 GPIO retained

Table 3: Power modes

For more information about power modes, see the Realtek RTL872xD data sheet [2] and Ameba-D application note [3].

2 Interfaces

2.1 Power supply

The power for NORA-W30 series modules is supplied through **VDD** pins with a nominal voltage of 3.3 VDC. The input voltage is also the input / output (I/O) reference voltage for interfacing external circuitry.

 The system power supply circuit must be able to support peak power. As the current drawn from **VDD** can vary significantly based on Wi-Fi and Bluetooth LE power consumption profiles.

NORA-W30 series modules use an integrated voltage converter to transform and stabilize the supply voltage applied to the **VDD** pin. The voltage converter operates in linear low drop-out mode (LDO) or switching power supply (SPS) mode. SPS is the default mode.

2.2 Low power clock

NORA-W36 series modules have an internal low frequency clock which is derived from the main clock. If low power modes are required, an external 32.768 kHz LPO signal, **EXT_32K**, can be supplied externally.

2.3 Module reset

NORA-W30 series modules can be reset (rebooted) with a low-level input on the **nRESET** pin. See also the NORA-W30 series system integration manual [\[1\]](#).

2.4 Bootstrap pins

Pins B1 (**PA30**), H2 (**SWD_DATA**), and A5 (**PA7**) are used to configure the boot mode. Default is pulled high for best power efficiency, booting normally from internal flash. See also the NORA-W30 series system integration manual [\[1\]](#).

2.5 RF antenna interface

The RF antenna interface of NORA-W30 modules supports Wi-Fi and Bluetooth LE on the same antenna. The different communication protocols are time divided on the antenna to switch between the Bluetooth and Wi-Fi data. Although communication using these different protocols is (more or less) transparent in the application, these protocols are never active at the same time in the module antenna.

NORA-W30 series modules support either an internal antenna (NORA-W306) or external antennas connected through a dedicated antenna pin (NORA-W301).

2.5.1 Internal antenna

NORA-W306 modules have internal antennas that are specifically designed and optimized for NORA modules. NORA-W306 module is equipped with a dual-band PCB trace antenna tuned for the 2.4 GHz and 5 GHz ISM bands.

For more information about antenna-related design, see also the NORA-W30 series system integration manual [\[1\]](#).

 The **ANT** signal solder pin is not available on the NORA-W306 module.

2.5.2 External RF antenna interface

The NORA-W301 module has an antenna signal (**ANT**) pin with a characteristic impedance of 50 Ω for using an external antenna. The antenna signal supports both Tx and Rx.

The external antenna, for example, can be an SMD antenna (or PCB integrated antenna) on the host board. An antenna connector for use with an external antenna through a coaxial cable could also be implemented. A cable antenna might be necessary if the module is mounted in a shielded enclosure such as a metal box or cabinet.

An external antenna connector (U.FL connector) reference design is available and must be followed to comply with the NORA-W30 FCC/ISED modular approvals. See the NORA-W30 series system integration manual [1] for the U.FL reference design and the list of approved antennas.

2.6 IO signals

NORA-W30 series modules have 20 pins available for general purpose input / output (GPIO). Specific functions are available on selected pins. A limited combination of data interfaces may be used at one time. For available assignments, see [Pin definition](#) and the system integrations manual [1].

2.6.1 PWM timer

The Pulse Width Modulation (PWM) timer consists of a 16-bit auto-reload up-counter driver by an 8-bit prescaler. It can be used for a variety of purposes, including measuring input pulse lengths (input capture) and generating output waveforms (PWM) that can be used to drive RGB LED devices.

The PWM controller is available on 12 high speed GPIO channels and 6 low power GPIO channels.

2.7 Data interfaces

Data interfaces are described in detail in the Realtek RTL8720DF data sheet [2] and user manual [3].

2.7.1 USI

The Universal Serial Interface (USI) is a high-speed peripheral that can be assigned as a universal asynchronous receiver transmitter (**UART**), a main or sub node inter integrated circuit (**I2C**), or a main or sub node serial peripheral interface (**SPI**). Use of the USI is in addition to other available UART, I2C or SPI instances, depending on GPIO pin availability.

One USI instance is available. It is a high-speed peripheral that powers down in sleep and deep sleep modes.

2.7.2 I2C

The Inter-Integrated Circuit (I2C) bus is a two-wire serial interface consisting of serial data (**SDA**) and serial clock (**SCL**) signals. These signals carry information between devices connected to the bus. Each device is recognized by a unique address and can operate as either a transmitter or receiver, depending on the function of the device. Devices can also be considered as main or sub nodes when performing data transfers. A main node device initiates a data transfer on the bus and generates the clock signal to permit the transfer. At that time, any device addressed is considered a sub node.



Each I2C interface can only be programmed to operate in either a main or sub node. Operating main or sub nodes simultaneously is not supported.

Three I2C instances are available. One high-speed and one associated with the USI power off in sleep and deep sleep modes. The low power instance powers off in sleep mode. When used as a sub node, the low-power instance can be used to wake NORA-W30 from sleep mode upon a decoded address match.

2.7.3 I2S

Inter-IC Sound (I2S) is a serial bus standard used for communication with digital audio devices. It communicates audio data between integrated circuits in an electronic device. The I2S bus separates clock and serial data signals, resulting in a lower jitter than typical communication systems that recover the clock from the data stream.

The I2S interface can operate as main or sub nodes, as a receiver, or a transmitter. It can address three different audio standards including the I2S Philips standard, the left-justified standard, and the right-justified standard.

One I2S instance is available. It is a high-speed peripheral and powers off sleep and deep sleep modes.

2.7.4 IR

The Infrared Radiation (IR) interface is designed to process IR signals with carrier frequencies of under 500 kHz. The hardware interface supports modulation with can be used on the IR transmission. It can also detect the period of continuous high- or low-level signal and record it in the RX FIFO. Application code then processes the serial signal.

One IR interface is available. It is a high-speed peripheral and powers off in sleep and deep sleep modes.

2.7.5 Key-scan

The key-scan interface automatically scans a keypad matrix and generates interrupts on activity. This frees the CPU from scanning a keypad from within an application. Key arrangements of up to 5 x 2 or 4 x 3 are supported.

One key-scan instance is available. It is a low-power peripheral that remains powered in sleep and deep sleep modes and can be used as a wake source.

2.7.6 Q-decoder

The Quadrature Decoder (Q-decoder or QDEC) interface is used to determine the position and speed of rotary devices, such as servomotors, volume control wheels, and PC mice. The decoded signals are used as sensory input to a system to determine the absolute or relative position of a rotary device, which can be used in a control loop.

One Q-decoder instance is available. It is a low power peripheral that is powered off in deep sleep.

2.7.7 RTC

The Real-Time Clock (RTC) is an independent Binary Coded Decimal (BCD) timer/counter. One 32-bit register contains seconds, minutes, hours (12- or 24-hour format) expressed in BCD format. A second 32-bit register contains the days expressed in binary format. RTC clock sources are derived from the system clock or low power clock, or **EXT_32K**, logic-level low frequency (32.768 kHz) clock input. **RTC_OUT** can be used as an alarm output.

One RTC instance is available. It is a low power peripheral that runs in all states – active, sleep, and deep sleep – and can be used as a wake source.

2.7.8 SDIO

Secure Digital Input / Output (SDIO) is a fast, 4-bit interface and may operate as a host or device with a clock rate of up to 50 MHz. SDIO 2.0 SDR25 (25 Mbytes / sec) is supported. SDIO can operate as a SD card host. INIC mode is supported for SDIO to Wi-Fi transformation.

One SDIO instance is available. It is a high-speed peripheral that is powered off in deep sleep mode.

2.7.9 SPI

The serial peripheral interface (SPI) is a synchronous serial communication consisting of four signals: clock (**CLK**), chip select (**CS**), main-in-sub-out (**MISO**) data, and main-out-sub-in (**MOSI**) data.

Three SPI instances are available, each operating as a main or sub mode. SPI0 can be configured with a maximum rate of 50 Mbps. SPI1 has a maximum rate of 25 Mbps. The third SPI port is associated with the **USI** peripheral, with a maximum rate of 50 Mbps. All SPI ports are powered off in sleep and deep sleep modes.

2.7.10 SPI Flash

The SPI Flash interface is a 4-bit memory interface that manages CPU instruction and data code access to external flash memory. It implements erase and program memory operations and read/write protection mechanisms. It accelerates code execution with a system of instruction and prefetch cache lines.

One SPI Flash instance is available. It is powered off in deep sleep mode.

2.7.11 UART

The Universal Asynchronous Receiver Transmitter (UART) is an asynchronous serial interface consisting of up to four signals – transmit data (**TXD**), receive data (**RXD**), request-to-send (**RTS**) handshake, and clear-to-send (**CTS**) handshake. The handshake signals are optional, though recommended at higher speeds.

Four UART instances are available. One is a high-speed peripheral. One is associated with the **USI**. Two are low-power peripherals. All UARTs are powered off in deep sleep.

2.7.12 USB

The Universal Serial Bus (USB, v2.0) utilizes two data signals as a bidirectional, differential pair to connect host computers and peripheral devices.

One USB peripheral interface is available. High-speed (HS, up to 480 Mbps), full-speed (FS, up to 12 Mbps), and low-speed (LS, up to 1.5 Mbps) modes are supported. The USB peripheral is powered off in sleep and deep sleep modes.

2.7.13 Wake sources

NORA-W30 can wake from sleep by the sources described in [Table 4](#).

Peripheral	Source	Remarks
HS_UART	Receive activity	
LP_UART	Receive activity	
COMP or ADC	Analog input level interrupt	
I2C	Wake on address match	I2C target mode only
BOD	Brown-out event	
WLAN	Wake on beacon interval	Default 102.4 ms
GPIO	PA[12], PA[13], PA[14], PA[15], PA[25], PA[26]	
TIMER	Wake on timer event	
AON	After deep sleep wake event	See Table 5

Table 4: Wake sources

NORA-W30 can wake from deep sleep by the sources described in [Table 5](#).

Peripheral	Source	Remarks
PDB	Power down event	
KEYSCAN	Key press on configured GPIOs	
TSF	WLAN Time sync	
RTC	Real time clock event	
AON_TIMER	Wake after a predetermined interval	
AON_GPIO	PA[12], PA[13], PA[14], PA[15], PA[25], PA[26]	

Table 5: Deep sleep wake sources

2.8 Analog interfaces

2.8.1 ADC

A 12-bit Successive Approximation Register (SAR) Analog-to-Digital Converter (ADC) is available on three GPIO pins. The input range is 0 V to 3.3 V. The maximum conversion rate is 1 M samples / second. The ADC remains on in sleep and deep sleep modes and can be used as a wake source.

2.9 Debug interface

2.9.1 SWD

NORA-W30 series uses the Arm® Serial Wire Debug (SWD) interface (**SWD_DATA** and **SWD_CLK**) for programming and debugging both cores of the Realtek RTL8720DF within the module.

3 Pin definition

3.1 NORA-W3 pin definition

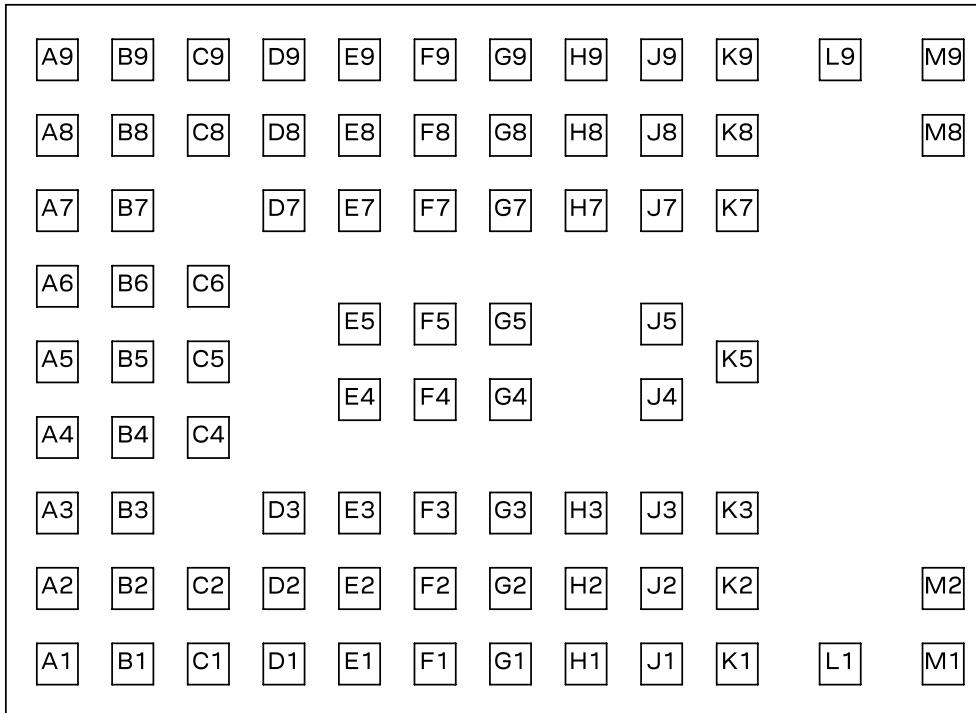

TOP VIEW

Figure 2: Pin layout

3.1.1 NORA-W30 open CPU pin assignments

Table 6 describes the NORA-W30 open CPU module pin assignments.

No	Name	I/O ¹	Boot strap	Alternate functions
A1	VSS	Power		
A2	n/c	-		
A3	n/c	-		
A4	n/c	-		
A5	PA[7]	I/O, PU	UART_DL	UART_LOG_TXD
A6	PA[8]	I/O, PU		UART_LOG_RXD
A7	VDD	Power		3.0 VDC to 3.6 VDC power supply input and I/O reference voltage
A8	VDD	Power		3.0 VDC to 3.6 VDC power supply input and I/O reference voltage
A9	VSS	Power		
B1	PA[30]	I/O, PU	SPS_SEL	HS_USI_SPI_CLK, HS_PWM7, LP_PWM1
B2	VSS	Power		
B3	PA[28]	I/O		LP_UART_CTS, HS_USI_SPI_CS, HS_PWM6, LP_PWM0, RREF
B4	n/c	-		

¹ I/O notations: I=Input only, I/O=Input or Output, PU=Pull Up, AI=Analog Input, n/c=Not Connected

No	Name	I/O ¹	Boot strap	Alternate functions
B5	n/c	-		
B6	n/c	-		
B7	VDD	Power		
B8	VSS	Power		
B9	n/c	-		
C1	PA[26]	I/O		LP_UART_TXD, HS_USI_SPI_MISO, IR_RX, LP_I2C_SDA, HS_PWM5, LP_PWM5, HSDP
C2	PA[25]	I/O		LP_UART_RXD, HS_USI_SPI_MOSI, IR_TX, LP_I2C_SCL, HS_PWM4, LP_PWM4, HSDM
C4	n/c	-		
C5	n/c	-		
C6	n/c	-		
C8	PB[23]	I/O		LP_TIM5_TRIG, SPI_DATA2, SD_D1, HS_PWM15, LP_PWM3, I2S_MCLK, QDEC_PHA, EXT_32K
C9	n/c	-		
D1	n/c	-		
D2	n/c	-		
D3	n/c	-		
D7	n/c	-		
D8	PB[1]	I/O, AI		LP_UART_TXD, HS_TIM4_TRIG
D9	n/c	-		
E1	n/c	-		
E2	n/c	-		
E3	n/c	-		
E4	VSS	Power		
E5	VSS	Power		
E7	n/c	-		
E8	PB[2]	I/O, AI		LP_UART_RXD, HS_TIM5_TRIG
E9	PB[22]	I/O		LP_TIM4_TRIG, SPI_DATA3, SD_D0, HS_PWM14, LP_PWM2, I2S_SD_RX, QDEC_PHB
F1	n/c	-		
F2	n/c	-		
F3	n/c	-		
F4	VSS	Power		
F5	VSS	Power		
F7	n/c	-		
F8	PB[21]	I/O		HS_USI_UART_RXD, HS_UART0_RTS, SPI0_CS, SPI_CLK, HS_USI_I2C_SDA, SD_CLK, HS_PWM13, LP_PWM1, I2S_WS, QDEC_IDX
F9	PB[20]	I/O		HS_USI_UART_TXD, HS_UART0_CTS, SPI0_CLK, SPI_DATA0, HS_USI_I2C_SCL, SD_CMD, HS_PWM12, LP_PWM0, I2S_CLK
G1	n/c	-		
G2	n/c	-		
G3	n/c	-		
G4	n/c	-		
G5	n/c	-		
G7	n/c	-		
G8	PB[19]	I/O		HS_UART0_TXD, HS_USI_UART_CTS, SPI0_MISO, SPI_DATA1, SD_D3, HS_PWM11, LP_PWM5, SWD_DATA, I2S_SD_TX0

No	Name	I/O ¹	Boot strap	Alternate functions
G9	PB[18]	I/O		HS_UART0_RXD, HS_USI_UART_RTS, SPI0_MOSI, SPI_CS, SD_D2, HS_PWM10, LP_PWM4, SWD_CLK
H1	n/c	-		
H2	PA[27]	I/O, PU	BL_EN	SWD_DATA (Default), LP_UART_RTS
H3	n/c	-		
H7	n/c	-		
H8	PA[15]	I/O		LP_UART_CTS, SPI1_CS, KEY_ROW2, KEY_COL6
H9	PA[14]	I/O		LP_UART_RTS, SPI1_CLK, I2S_SD_TX2, KEY_ROW2
J1	n/c	-		
J2	PB[3]	I/O, AI		SWD_CLK (Default)
J3	nRESET	I, PU		
J4	n/c	-		
J5	n/c	-		
J7	n/c	-		
J8	PA[13]	I/O		LP_UART_RXD, SPI1_MISO, HS_PWM1, LP_PWM1, I2S_SD_TX1, KEY_ROW1
J9	PA[12]	I/O		LP_UART_TXD, SPI1_MOSI, HS_PWM0, LP_PWM0, I2S_MCLK, KEY_ROW0
K1	n/c	-		
K2	VSS	Power		
K3	VSS	Power		
K5	VSS	Power		
K7	VSS	Power		
K8	VSS	Power		
K9	ANT	I/O		50 Ω Single-ended antenna connection, only connected on NORA-W361
L1	VSS	Power		
L9	VSS	Power		
M1	VSS	Power		
M2	VSS	Power		
M8	VSS	Power		
M9	VSS	Power		

Table 6: NORA-W30 open CPU pinout table

The alternate pin functions are described in [Table 7](#).

Only certain functions may be enabled at one time. For more information about pin multiplexing, see also the system integration guide [\[1\]](#).

Signal	I/O	Description
EXT_32K	O	32.768 kHz clock output
HSDM	I/O	USB data signal minus
HSDP	I/O	USB data signal plus
HS_PWM0	O	High speed PWM output, channel 0
HS_PWM1	O	High speed PWM output, channel 1
HS_PWM4	O	High speed PWM output, channel 4
HS_PWM5	O	High speed PWM output, channel 5
HS_PWM6	O	High speed PWM output, channel 6
HS_PWM7	O	High speed PWM output, channel 7
HS_PWM10	O	High speed PWM output, channel 10
HS_PWM11	O	High speed PWM output, channel 11

Signal	I/O	Description
HS_PWM12	O	High speed PWM output, channel 12
HS_PWM13	O	High speed PWM output, channel 13
HS_PWM14	O	High speed PWM output, channel 14
HS_PWM15	O	High speed PWM output, channel 15
HS_TIM4_TRIG	I	High speed timer capture, channel 4
HS_TIM5_TRIG	I	High speed timer capture, channel 5
HS_UART0_CTS	I	High speed UART0, clear to send
HS_UART0_RTS	O	High speed UART0, ready to send
HS_UART0_RXD	I	High speed UART0, receive data
HS_UART0_TXD	O	High speed UART0, transmit data
HS_USI_I2C_SCL	O	High speed universal serial interface, I2C clock
HS_USI_I2C_SDA	I/O	High speed universal serial interface, I2C data
HS_USI_SPI_CLK	O	High speed universal serial interface, SPI clock
HS_USI_SPI_CS	O	High speed universal serial interface, chip select
HS_USI_SPI_MISO	I	High speed universal serial interface, main in sub out
HS_USI_SPI_MOSI	O	High speed universal serial interface, main out sub in
HS_USI_UART_CTS	I	High speed universal serial interface, UART clear to send
HS_USI_UART_RTS	O	High speed universal serial interface, UART ready to send
HS_USI_UART_RXD	I	High speed universal serial interface, UART receive data
HS_USI_UART_TXD	O	High speed universal serial interface, UART transmit data
I2S_MCLK	O	I2S main clock output
I2S_SD_RX	I	I2S data input
I2S_SD_TX0	O	I2S data output 0
I2S_SD_TX1	O	I2S data output 1
I2S_SD_TX2	O	I2S data output 2
I2S_CLK	I/O	I2S data clock
I2S_WS	I/O	I2S word select
IR_RX	I	Infrared receive
IR_TX	O	Infrared transmit
KEY_COLO	O	Keypad column 0
KEY_COL1	O	Keypad column 1
KEY_COL5	O	Keypad column 5
KEY_COL6	O	Keypad column 6
KEY_ROW0	I	Keypad row 0
KEY_ROW1	I	Keypad row 1
KEY_ROW2	I	Keypad row 2
KEY_ROW3	I	Keypad row 3
KEY_ROW4	I	Keypad row 4
LP_I2C_SCL	O	Low power I2C clock
LP_I2C_SDA	I/O	Low power I2C data
LP_PWM0	O	Low power PWM output, channel 0
LP_PWM1	O	Low power PWM output, channel 1
LP_PWM2	O	Low power PWM output, channel 2
LP_PWM3	O	Low power PWM output, channel 3
LP_PWM4	O	Low power PWM output, channel 4
LP_PWM5	O	Low power PWM output, channel 5

Signal	I/O	Description
LP_TIM4_TRIG	I	Low power timer capture, channel 5
LP_TIM5_TRIG	I	Low power timer capture, channel 5
LP_UART_CTS	I	Low power UART clear to send
LP_UART_RTS	O	Low power UART request to send
LP_UART_RXD	I	Low power UART receive data
LP_UART_TXD	O	Low power UART transmit data
QDEC_IDX	I	Quadrature decoded index pulse
QDEC_PHA	I	Quadrature decoded index phase A
QDEC_PHB	I	Quadrature decoded index phase B
RREF	AI	USB reference resistor, use 1% (value undefined)
SD_CLK	O	SDIO clock
SD_CMD	O	SDIO command
SD_D0	I/O	SDIO data 0
SD_D1	I/O	SDIO data 1
SD_D2	I/O	SDIO data 2
SD_D3	I/O	SDIO data 3
SPIO_CLK	O	High speed SPI0, SPI clock
SPIO_CS	O	High speed SPI0, chip select
SPIO_MISO	I	High speed SPI0, main in sub out
SPIO_MOSI	O	High speed SPI0, main out sub in
SPI1_CLK	O	High speed SPI1, SPI clock
SPI1_CS	O	High speed SPI1, chip select
SPI1_MISO	I	High speed SPI1, main in sub out
SPI1_MOSI	O	High speed SPI1, main out sub in
SPI_CLK	O	Quad SPI clock
SPI_CS	O	Quad SPI chip select
SPI_DATA0	I/O	Quad SPI data 0
SPI_DATA1	I/O	Quad SPI data 1
SPI_DATA2	I/O	Quad SPI data 2
SPI_DATA3	I/O	Quad SPI data 3
SWD_CLK	O	Serial wire debug clock
SWD_DATA	I/O	Serial wire debug data
UART_LOG_RXD	I	Debug UART receive data
UART_LOG_TXD	O	Debug UART transmit data

Table 7: Alternate function signal descriptions

4 Electrical specifications

Stressing the device above one or more of the ratings listed in the [Absolute maximum ratings](#) section may cause permanent damage. These are stress ratings only.

Operating the module at these or at any conditions other than those specified in the [Recommended operating conditions](#) should be avoided. Exposure to absolute maximum rating conditions for extended periods can affect device reliability.

All given application information is only advisory and does not form part of the specification.

4.1 Absolute maximum ratings

Symbol	Description	Condition	Min	Max	Unit
VDD	Module supply voltage	Input DC voltage at VDD pins	-0.3	3.63	V
I _{VDD MAX}	Absolute maximum power consumption ²	3.3 VDC power supply		800	mA
T _{STR}	Storage temperature		-40	+105	°C

Table 8: Absolute maximum ratings

The product is not protected against overvoltage or reversed voltages. If necessary, voltage spikes exceeding the power supply voltage specification shown in [Table 8](#) must be limited to values within the specified boundaries by using appropriate protection devices.

4.1.1 ESD characteristics

Parameter	Min.	Typical	Max.	Unit	Remarks
Human body model (HBM)			±2000	V	JEDEC EIA/JESD22-A114
Charge device model (CDM)			± 500	V	JEDEC EIA/JESD22-C101

Table 9: ESD characteristics

4.2 Recommended operating conditions

4.2.1 Operating temperature

Parameter	Min.	Max.	Unit
Operating temperature	-40	+105	°C

Table 10: Temperature range

4.2.2 Supply / power pins

The input supply can operate at a nominal input voltage of 3.3 VDC.

Symbol	Parameter	Condition	Min	Typ	Max	Unit
VDD	Input supply voltage	Ambient temperature -40 °C to +105 °C	3.00	3.30	3.60	V
t _{PRDY}	VDD ramp up to 1.76 VDC		0.1	0.6	4.6	ms
t _{CORE}	MCU HS core power ready			15		ms
t _{BOOT}	MCU HS core boot time		200	200		ms

Table 11: Input characteristics of voltage supply pins

² 800 mA @ 40 µsec during WLAN channel enable and change.

4.2.3 I2C pull-up resistor values

NORA-W30 series has configurable, internal pull-up and pull-down resistors. A minimum value of 4.7 kΩ may be selected on pins assigned to I2C functionality.

4.2.4 nRESET pin

Pin name	Parameter	Min	Typ	Max	Unit
nRESET	Low-level input	0		0.2*VDD	V
	Internal pull-up resistance		10		kΩ
t _{RESET}	Minimum nRESET low pulse	1	1		ms

Table 12: nRESET pin characteristics

4.2.5 Low frequency clock

NORA-W36 series modules have an internal low frequency clock which is derived from the main clock. If low power modes are required, an external 32.768 kHz LPO signal – **EXT_32K** – can be supplied externally. Voltage levels are defined at [Digital pins](#).

Symbol	Parameter	Min	Typ	Max	Unit
EXT_32K	Input clock frequency		32.768		kHz

Table 13: External LPO clock characteristics

4.2.6 Digital pins

Digital pin specifications depend on the power supply voltage, **VDD**.

Pin name	Parameter	Min	Typ	Max	Unit	Remarks
Any digital pin	Input characteristic: Low-level input	0		0.8	V	
	Input characteristic: high-level input	2.0		VDD	V	
	Output characteristic: Low-level output	0		0.4	V	
	Output characteristic: High-level output	2.4		VDD	V	
	Drive capability	3.6		23.3	mA	For drive settings, see [2] and [3]
	Loading capacitance			15	pF	
	Pull-up/pull-down resistance	4.7		50	kΩ	For pull settings, see [2] and [3]

Table 14: Digital pin characteristics at VDD=3.3 VDC

4.2.7 Current consumption

The typical current consumption of a NORA-W30 module is shown in [Table 15](#). The current consumption is highly dependent on the application implementation. All measurements taken with 3.3 V supply at 25 °C except as noted.

The current consumption figures are inherited from the Realtek RTL 8720DF data sheet [2].

Power mode	Activity	Min.	Typ.	Unit	Remarks
Wi-Fi	Wi-Fi Tx packet P _{OUT} 17 dBm, Ch7/MCS0/Bandwidth 20 MHz		252	mA	
	Wi-Fi Tx packet P _{OUT} 15 dBm, Ch100/MCS0/Bandwidth 20 MHz		300	mA	
	Wi-Fi Rx and listening		63	mA	

Power mode	Activity	Min.	Typ.	Unit	Remarks
Bluetooth LE	Bluetooth Tx Pout 8 dBm		100	mA	
	Bluetooth Rx and listening		60	mA	
Active	CPU 200 MHz RF off		20	mA	
Sleep mode	CPU idle RF off Interrupts on SRAM: all retained LP wake sources enabled		75	μA	
Deep sleep mode	CPU off RF off Interrupts off SRAM: 1Kbyte retained LP wake sources disabled		10	μA	

Table 15: Current consumption during typical use cases

4.2.8 Wi-Fi radio characteristics

 $V_{DD} = 3.3\text{ V}$, $T_{amb} = 25\text{ °C}$

Parameter	Operation mode		Specification	Unit
RF frequency range	802.11a/n		5.180 – 5.825	GHz
	802.11b/g/n		2.412 – 2.472	GHz
	802.11b/g/n	(Japan only)	2.412 – 2.484	GHz
Modulation	802.11b		CCK and DSSS	
	802.11a/g/n		OFDM	
Supported Data Rates	802.11a		6, 9, 12, 18, 24, 36, 48, 54	Mbit/s
	802.11b		1, 2, 5.5, 11	Mbit/s
	802.11g		6, 9, 12, 18, 24, 36, 48, 54	Mbit/s
	802.11n		MCS0 – MCS7	
Supported Bandwidth	802.11n		20, 40	MHz
Supported Guard Interval	802.11n		400, 800	ns
Conducted Transmit Power (typical)	2.4 GHz CCK	1 Mbit/s	20	dBm*
		11 Mbit/s	18	dBm*
	2.4 GHz OFDM	6 Mbit/s	19	dBm*
		54 Mbit/s	17	dBm*
	2.4 GHz HT20 / HT40	MCS0	18	dBm*
		MCS7	16	dBm*
	5 GHz OFDM	6 Mbit/s	18	dBm*
		54 Mbit/s	14	dBm*
	5 GHz HT20 / HT40	MCS0	16	dBm*
		MCS7	13	dBm*
Receiver Sensitivity (typical)	2.4 GHz CCK	1 Mbit/s	-98	dBm
		11 Mbit/s	-91	dBm
	2.4 GHz OFDM	6 Mbit/s	-95	dBm
		54 Mbit/s	-77	dBm
	2.4 GHz HT20	MCS0	-95	dBm
		MCS7	-75	dBm
	2.4 GHz HT40	MCS0	-93	dBm

Parameter	Operation mode		Specification	Unit
		MCS7	-72	dBm
	5 GHz OFDM	6 Mbit/s	-93	dBm
		54 Mbit/s	-76	dBm
	5 GHz HT20	MCS0	-93	dBm
		MCS7	-74	dBm
	5 GHz HT40	MCS0	-91	dBm
		MCS7	-71	dBm

* There is lower output power on band edge channels and certain regulatory domains.

Table 16: Wi-Fi radio characteristics

4.2.9 Bluetooth LE characteristics

$V_{DD} = 3.3\text{ V}$, $T_{amb} = 25\text{ °C}$

Parameter	Specification	Unit
RF Frequency Range	2.400 – 2.4835	GHz
Supported Modes	Bluetooth LE 5.3	
Number of channels	40	
Modulation	GFSK	
Transmit Power (typical)	8 ± 1 (NORA-W306), 6.5 ± 1 (NORA-W301)	dBm
Receiver Sensitivity (typical)	-101 ± 2	dBm

* Conducted output power.

Table 17: Bluetooth LE characteristics

4.2.10 Antenna radiation patterns

Antenna patterns for approved antennas associated with NORA-W301 can be found in the respective antenna data sheet. See the NORA-W30 system integration manual [1] for the list of approved antennas.

Table 18 and Table 19 show radiation patterns for NORA-W306.

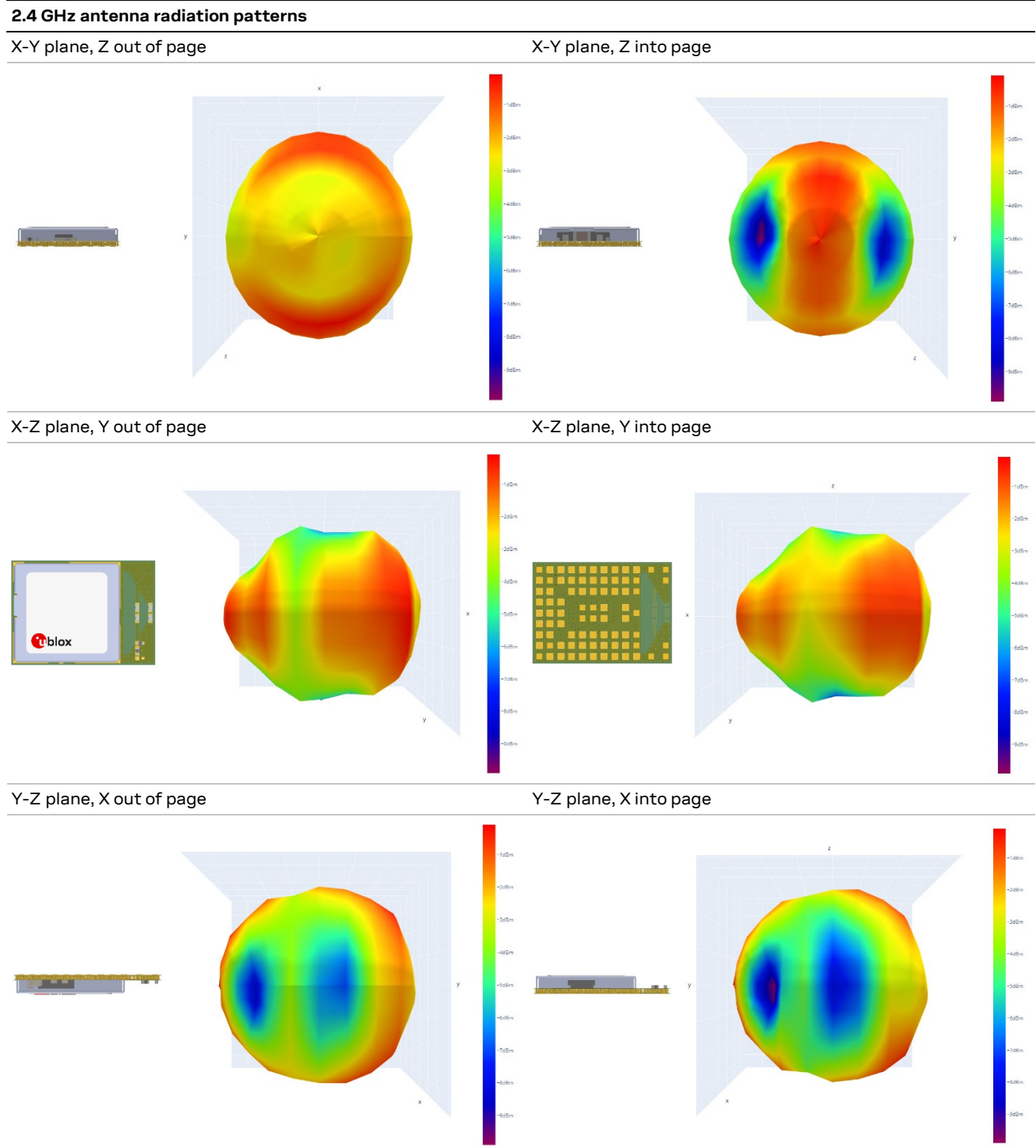
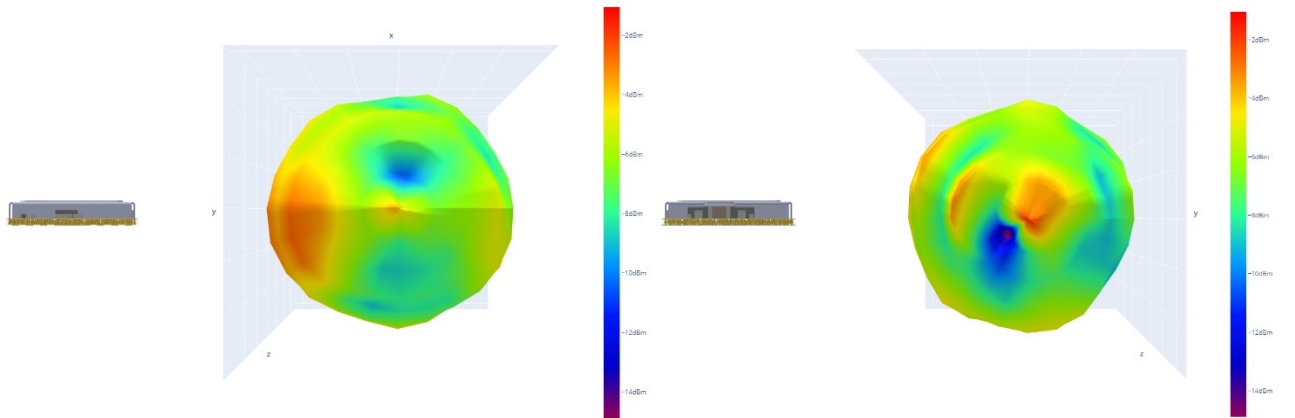

Table 18: NORA-W306 Wi-Fi and Bluetooth antenna characteristics in the 2.4 GHz band

5 GHz antenna radiation patterns

X-Y plane, Z out of page

X-Y plane, Z into page



X-Z plane, Y out of page

X-Z plane, Y into page

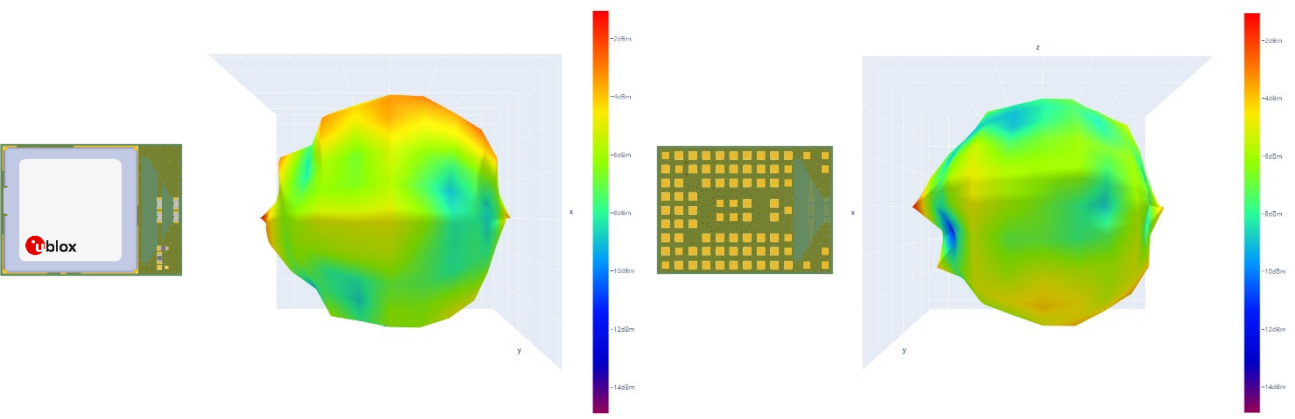

Y-Z plane, X out of page

Y-Z plane, X into page

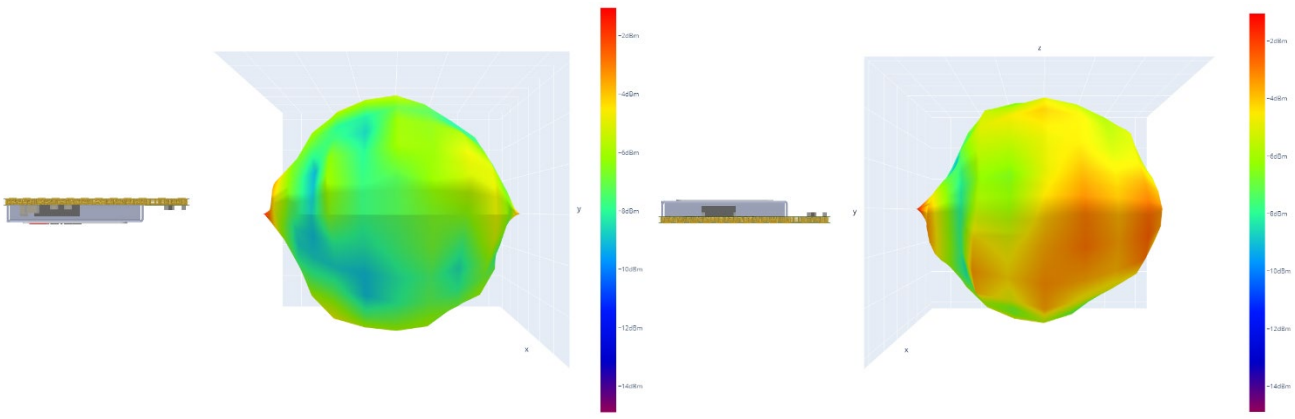
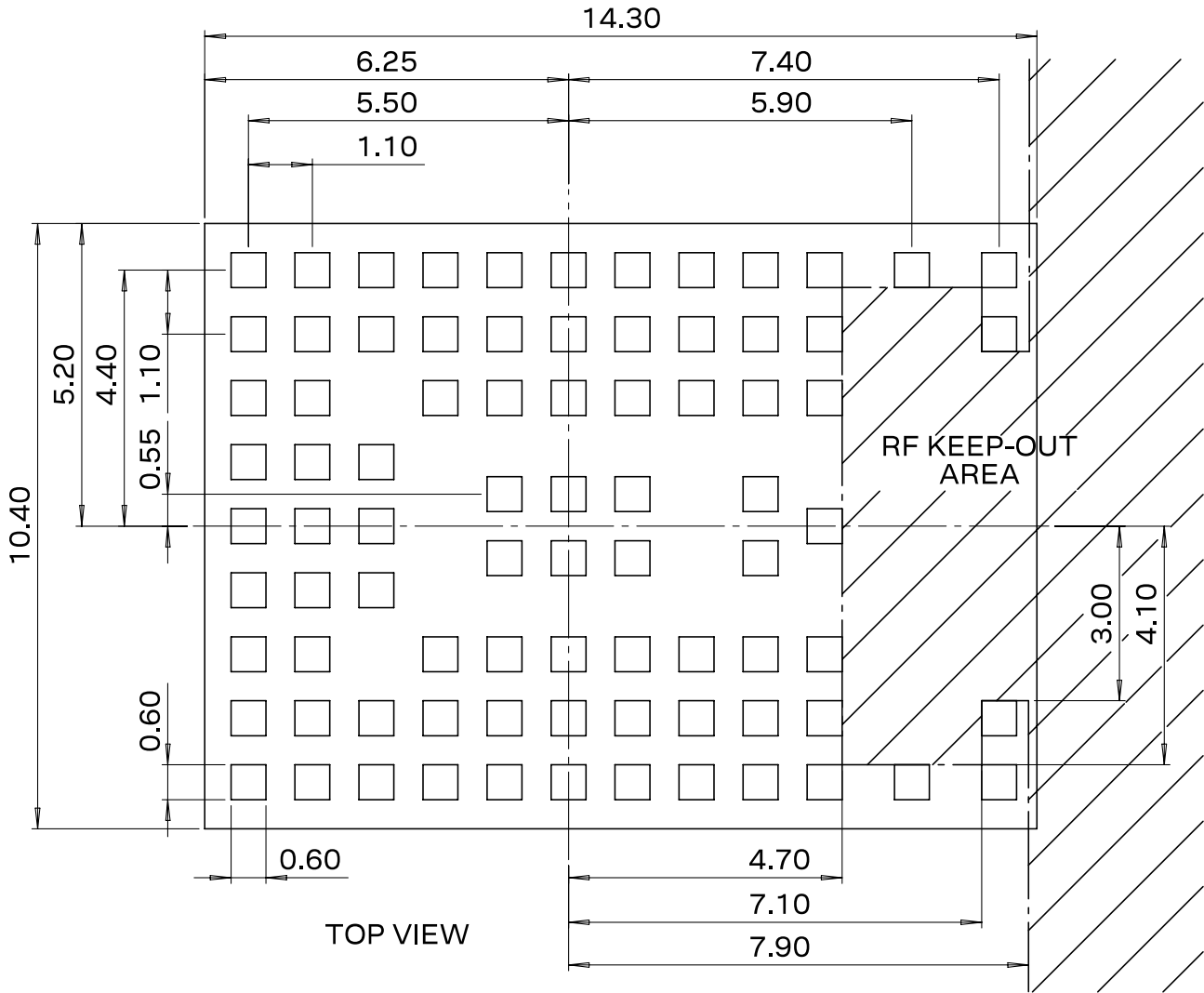

Table 19: NORA-W306 Wi-Fi antenna characteristics in the 5 GHz band

5 Mechanical specifications

5.1 NORA-W30 footprint dimensions

Figure 3 shows the common footprint and dimensions of NORA-W30 series modules that are shared across the whole product family.



All dimensions in mm.

Figure 3: NORA-W30 footprint dimensions

The RF keep-out area is only required for NORA-W306 modules.

5.2 NORA-W30 mechanical specifications

5.2.1 NORA-W301 mechanical specifications

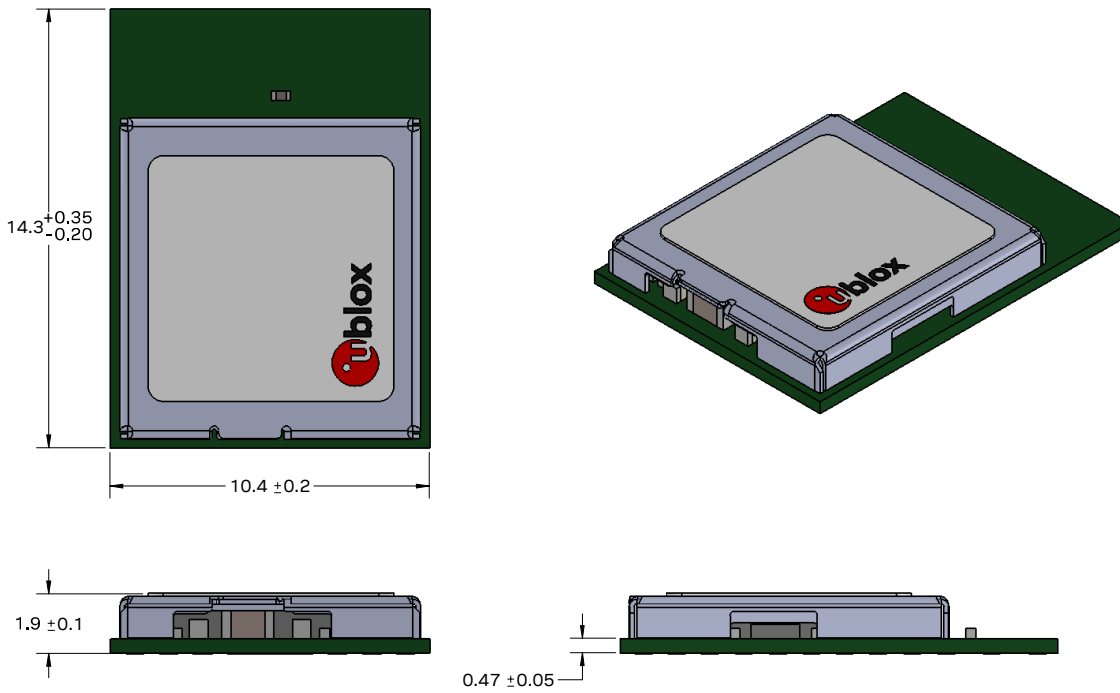

Dimensions in mm

Figure 4: NORA-W301 mechanical specification

5.2.2 NORA-W306 mechanical specifications

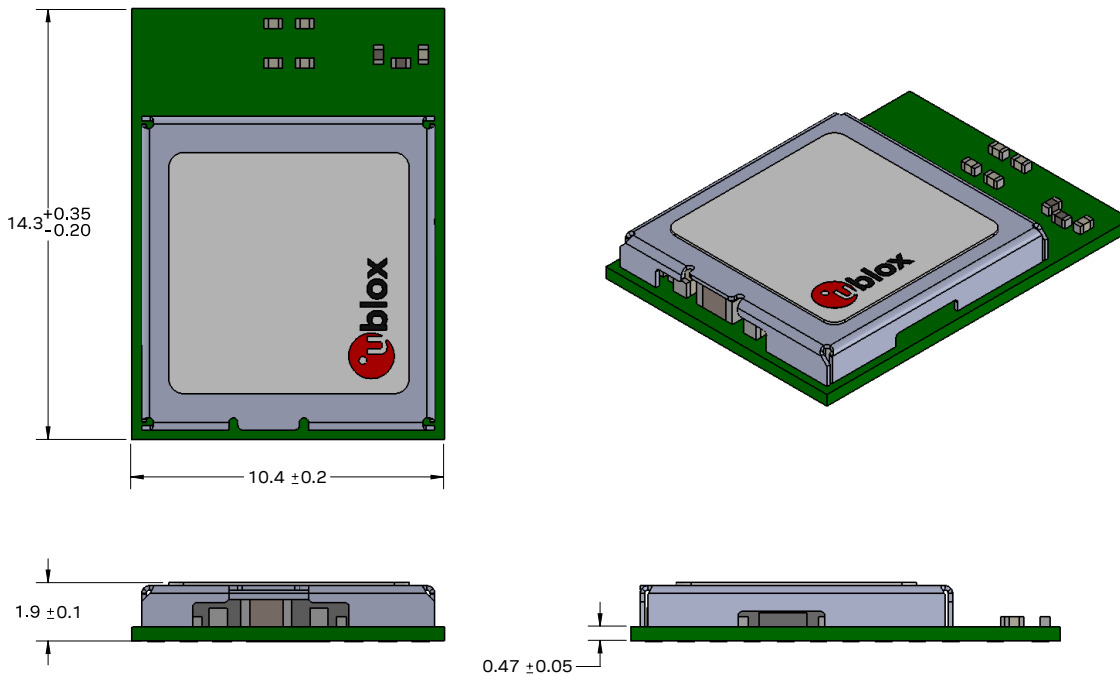

Dimensions in mm

Figure 5: NORA-W306 mechanical specification

6 Qualifications and approvals

6.1 Country approvals

The NORA-W30 module series is certified for use in the countries/regions shown in

Country	Agency	Approval
Europe	RED	Approved
Great Britain	UKCA	Approved
USA	FCC	Approved
Canada	ISED	Approved
Japan	MIC	Pending
Taiwan	NCC	Pending
South Korea	KCC	Pending
Australia and New Zealand	ACMA	Pending
Brazil	ANATEL	Pending
South Africa	ICASA	Pending

Table 20: Country approvals

 For detailed information about the regulatory requirements that must be met when using NORA-W30 modules in an end-product, see the NORA-W30 series SIM [\[1\]](#).

6.2 Bluetooth qualification



NORA-W30 series is a Bluetooth qualified design, listed in accordance with the Bluetooth specification.

All products that use Bluetooth technology must be qualified with the [Bluetooth Special Interest Group \(SIG\)](#) to obtain its own declaration ID. This is applicable also for products that are using an already Bluetooth qualified module.

The Bluetooth Qualification Process is initiated at the [Bluetooth SIG Launch Studio website](#). When submitting the qualification, use the “Qualification without required testing” path, and reference the QDID listed in [Table 21](#).

Product type	Declaration ID	Referenced QDID
End product	D065864	194774

Table 21: Bluetooth qualified design ID for NORA-W30 series

6.3 Environmental

6.3.1 RoHS

NORA-W30 series modules are in compliance with Directive 2011/65/EU (EU RoHS 2) and its amendment, Directive 2015/863 (EU RoHS3) of the European Parliament and the Council on the restriction of the use of certain hazardous substances in electrical and electronic equipment.

6.3.2 REACH

NORA-W30 series modules do not contain the SVHC (Substance of Very High Concern), as defined by Directive EC/1907/2006 Article according to REACH Annex XVII.

6.4 Antennas

NORA-W306 includes an internal PCB antenna, whereas NORA-W301 is equipped with an antenna pin for connecting an external antenna. For information about the approved antennas for use with NORA-W30 modules, see the system integration manual [\[1\]](#).

7 Product handling

7.1 Packaging

7.1.1 Reels

NORA-W30 series modules are delivered as hermetically sealed, reeled tapes to enable efficient production, production lot set-up and tear-down. For more information about packaging, see the Product packaging reference guide [5].

NORA-W30 modules are delivered in quantities of 500 pieces on a reel.

The reel types for NORA-W30 modules are shown in Table 22, with more detailed information included in the Product packaging reference guide [5].

Model	Reel type
NORA-W301	A3
NORA-W306	A3

Table 22: Reel types for different NORA-W30 series modules

7.1.2 Tapes

Figure 6 and Figure 7 show the position and orientation of NORA-W30 modules as they are delivered on tape. The dimensions of the tapes are specified in Figure 8.



Figure 6: NORA-W301 module on tape orientation

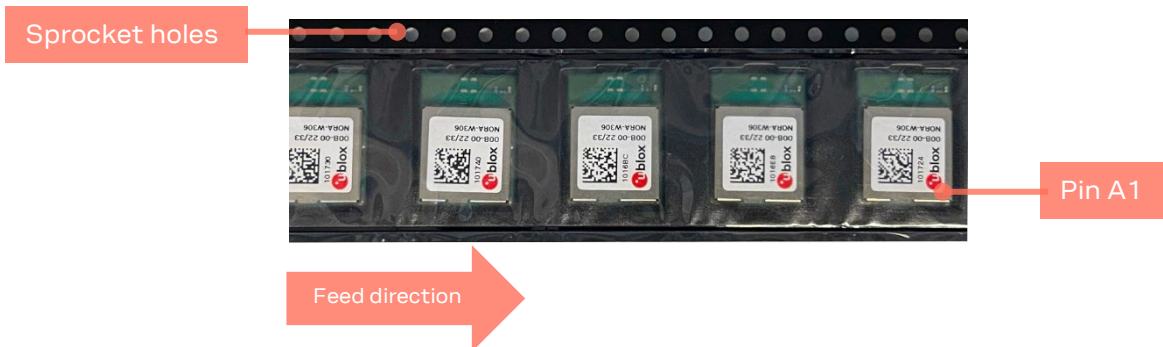
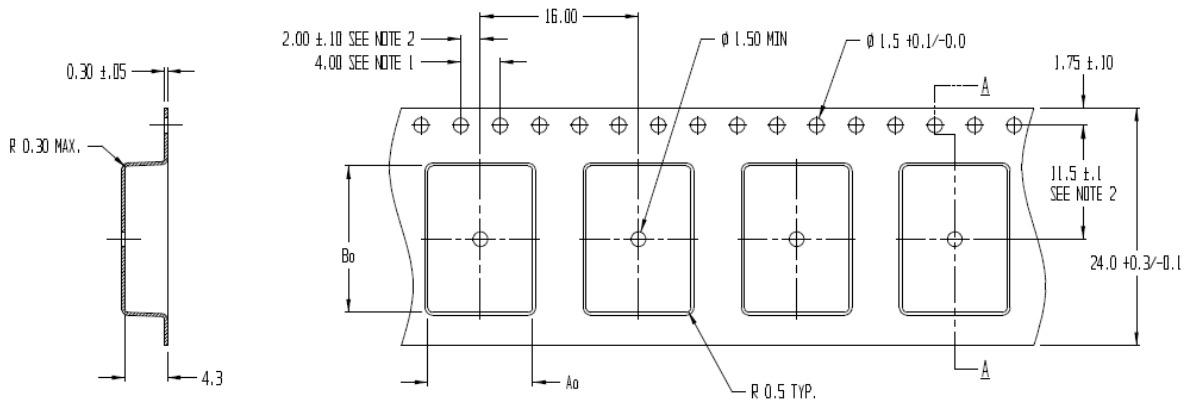

Figure 7: NORA-W306 module on tape orientation



SECTION A - A

$A_0 = 10.6$
 $B_0 = 14.8$
 $K_0 = 4.3$

NOTES:

1. 10 SPROCKET HOLE PITCH CUMULATIVE TOLERANCE ± 0.2
2. POCKET POSITION RELATIVE TO SPROCKET HOLE MEASURED AS TRUE POSITION OF POCKET, NOT POCKET HOLE
3. A_0 AND B_0 ARE CALCULATED ON A PLANE AT A DISTANCE "R" ABOVE THE BOTTOM OF THE POCKET.

Figure 8: NORA-W301/NORA-W306 tape dimensions

7.2 Moisture sensitivity levels

- The NORA-W30 series modules are Moisture Sensitive Devices (MSD) in accordance with the IPC/JEDEC specification.

The Moisture Sensitivity Level (MSL) relates to the required packaging and handling precautions. The NORA-W30 series modules are rated at MSL level 4. For more information regarding moisture sensitivity levels, labeling, and storage, see the Product packaging reference guide [5].

- For MSL standards, see IPC/JEDEC J-STD-020, which can be downloaded from www.jedec.org.

7.3 Reflow soldering

Reflow profiles are to be selected according to u-blox recommendations. See NORA-W30 series system integration manual [1] for more information.

- Failure to observe these recommendations can result in severe damage to the device.

7.4 ESD precautions

-  NORA-W30 series modules contain highly sensitive electronic circuitry and are Electrostatic Sensitive Devices (ESD). Handling the NORA-W30 series modules without proper ESD protection may destroy or damage them permanently.



NORA-W30 series modules are electrostatic sensitive devices (ESD) and require special ESD precautions typically applied to ESD sensitive components. See also [Maximum ESD ratings](#).

Proper ESD handling and packaging procedures must be applied throughout the processing, handling and operation of any application that incorporates the NORA-W30 series module. The ESD precautions should be implemented on the application board where the module is mounted as described in the NORA-W30 series system integration manual [1].

-  Failure to observe these recommendations can result in severe damage to the device.

8 Labeling and ordering information

8.1 Product labeling

The labels (8 x 8 mm) of the NORA-W30 series modules described in the section include important product information.

Figure 9 shows the label of all the NORA-W30 series modules, which includes product type number and revision, production date, and data matrix that bears a unique serial number and the u-blox logo.

All units in mm unless specified stated otherwise.

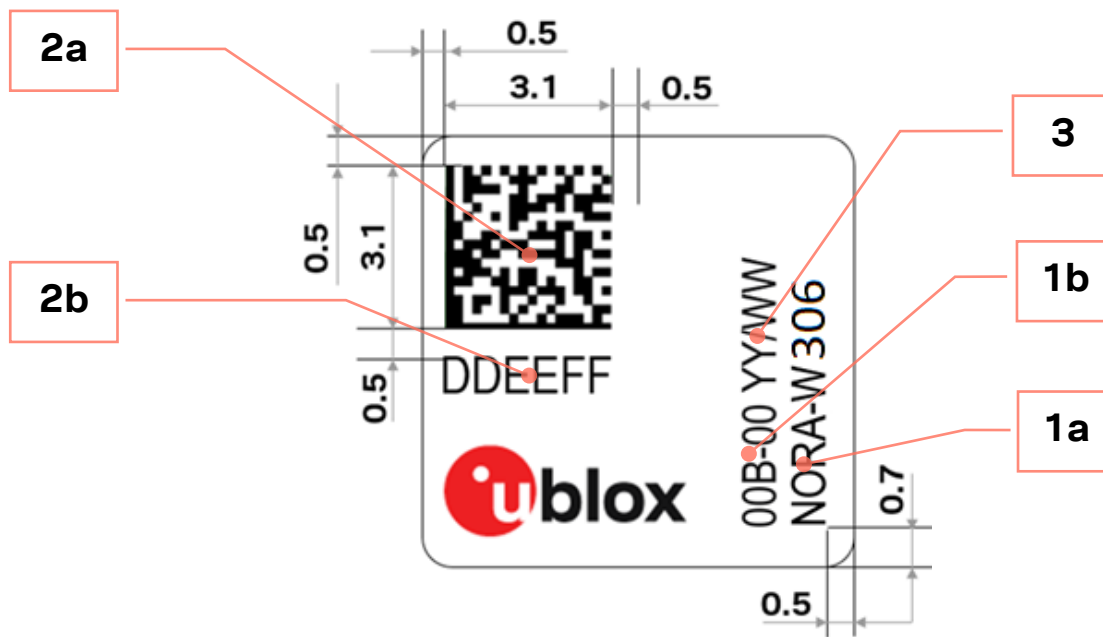

Figure 9: Location of product type number on the NORA-W30 series module label

Reference	Description
1a	Product Name (Applicable model names: NORA-W301, NORA-W306).
1b	Product type number suffix.
2a	Data Matrix with unique serial number comprising 19 alphanumeric symbols: <ul style="list-style-type: none"> The first 3 symbols are used for production tracking and are an abbreviated representation of the Type number that is unique to each module variant. The following 12 symbols represent the unique hexadecimal Bluetooth address of the module AABCCDDEEFF, and The last 4 symbols represent the hardware and firmware version encoded HFFF.
2b	The six last hex symbols of the MAC address (AABCCDDEEFF).
3	Date of production encoded YY/WW (year/week).

Table 23: NORA-W30 series label description

8.2 Ordering information

Ordering code	Product
NORA-W301-00B	Module with antenna pin. Open CPU version. Using RTL8720DF.
NORA-W306-00B	Module with internal PCB trace antenna. Open CPU version. Using RTL8720DF.

Table 24: Product ordering codes

Appendix

A Glossary

Abbreviation	Definition
ADC	Analog to Digital Converter
AON	Always ON
ARM	Arm (Advanced RISC Machines) Holdings
BOD	Brown-Out Detect
CDM	Charge Device Model
COMP	Comparator
CPU	Central Processing Unit
ESD	ElectroStatic Discharge
IEEE	Institute of Electrical and Electronics Engineers
GATT	Generic Attributes
GPIO	General Purpose Input / Output
HBM	Human Body Model
I2C	Inter Integrated Circuit
I2S	Inter-IC Sound
IOT	Internet of Things
IR	Infrared Radiation
LAN	Local Area Network
LPO	Low Power Oscillator
MAC	Media Access Controller
MCU	Microcontroller Unit
MSL	Moisture Sensitivity Level
PCB	Printed Circuit Board
PCBA	Printed Circuit Board Assembly
PWM	Pulse Width Modulation
QDEC	Quadrature Decoder
RF	Radio Frequency
RTC	Real-Time Clock
SDIO	Secure Digital Input / Output
SPI	Serial Peripheral Interface
SWD	Serial Wire Debug
TBD	To Be Decided
TLS	Transport Layer Security
UART	Universal Asynchronous Receiver Transmitter
USB	Universal Serial Bus
USI	Universal Serial Interface
WLAN	Wireless LAN
WPA	Wi-Fi Protected Access

Table 25: Explanation of the abbreviations and terms used

Related documentation

- [1] NORA-W30 system integration manual, [UBX-22021119](#)
- [2] Realtek UM0401 RTL872xD [data sheet](#)
- [3] Realtek UM0400 Ameba-D [user manual](#)
- [4] Realtek AN0400 Ameba-D [application note](#)
- [5] Product packaging reference guide, [UBX-14001652](#)

 For product change notifications and regular updates of u-blox documentation, register on our website, www.u-blox.com.

Revision history

Revision	Date	Name	Comments
R01	14-Oct-2022	brec	Initial release
R02	8-Nov-2022	brec	Added LP_UART in Wake sources . Revised alternate function signal descriptions in NORA-W30 open CPU pin assignments . Revised disclosure restriction class.
R03	12-Dec-2022	cmag	Revised product status in Document information .
R04	20-Dec-2023	brec	Revised product status in Document information , updated Bluetooth LE 5 to Bluetooth LE 5.3, added link to UM0400 Ameba-D user manual, updated Absolute maximum rating table.
R05	26-Apr-2024	brec	Updated table data to define typical Bluetooth conducted and radiated output power for NORA-W306 and NORA-W301 in Radio performance . Updated NORA-W30 open CPU pinout table data with revised descriptions for alternate functions in NORA-W30 open CPU pin assignments . Revised maximum storage temperature in Absolute maximum ratings . Added parameter values describing input characteristics for Supply / power pins . Revised table data describing current consumption during typical use cases in Current consumption . Added Antenna radiation patterns . Added approval status in Country approvals . Included qualified design IDs together with other revisions in Bluetooth qualification . Revised I2C and SPI terminology to align with contemporary language standards.

Contact

u-blox AG

Address: Zürcherstrasse 68
8800 Thalwil
Switzerland

For further support and contact information, visit us at www.u-blox.com/support.

X-ON Electronics

Largest Supplier of Electrical and Electronic Components

Click to view similar products for [Multiprotocol Modules](#) category:

Click to view products by [U-Blox](#) manufacturer:

Other Similar products are found below :

[9260.NGWG.NV 958867](#) [AX210.NGWG.NV](#) [BM833](#) [ESP32-C3-MINI-1U-H4](#) [ESP32-WROOM-32U-16MB](#) [ESP32-WROOM-32UE](#)
[ESP32-WROOM-32D-H4](#) [ESP32-WROOM-32U-H4](#) [ESP32-PICO-MINI-02U-N8R2](#) [ESP32-C6-WROOM-1-N4](#) [ESP32-C6-WROOM-1U-N4](#)
[ESP32-C6-WROOM-1-N8](#) [BE200.NGWG.NV](#) [BE200.NGWG](#) [BE202.NGWG.NV](#) [BE200.NGWG.NVX](#) [AX411.NGWG.NV](#) [AX210.D2WG](#)
[AX210.NGWG.NVX](#) [AX211.NGWG](#) [EC200UEUAA-N05-TA0AA](#) [SC20ELSATEA-8GB-UGAD](#) [SG560DEUPA-U61-TA0AA](#)
[AX211.NGWG.NV](#) [ISM43340-M4G-L44-10CF-C6.2.1.11](#) [KG100SABMD](#) [BC40P](#) [S007-PIN254](#) [S007-PIN127](#) [ESP32-C3-12F](#)
[FC41DAHMD](#) [EWM-W179M201E](#) [ESP32-C6-WROOM-1U-N8](#) [ATWILC3000-MR110CA](#) [RS9113-NBZ-D5W](#) [ATWINC3400-](#)
[MR210UA122](#) [ESP32-WROOM-32](#) [AMPAK AP12356 WIFI/BT KIT](#) [AIW-154BN](#) [AIW-165BN](#) [AIW-166K1](#) [AIW-166K2](#) [AIW-166K3](#)
[AIW-166K4](#) [AIW-355 DQ-N01](#) [AIW-355 DQ-C01](#) [EWM-W159M201E](#) [EWM-W192K1](#) [EWM-W192K2](#) [W106C](#)