

ZOE-M8

Ultra-small u-blox M8 GNSS SiP modules Data Sheet

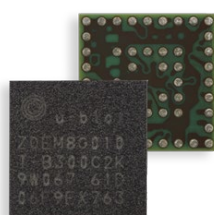

Abstract

Technical data sheet describing the ZOE-M8 ultra-small SiP modules with superior performance. The modules provide a fully integrated, complete solution, reducing design and test efforts. They are ideal for passive antennas, due to built-in SAW and LNA and have high accuracy thanks to concurrent reception of up to 3 GNSS.

Document Information

Title	ZOE-M8	
Subtitle	Ultra-small u-blox M8 GNSS SiP modules	
Document type	Data Sheet	
Document number	UBX-16008094	
Revision and date	R08	14-Aug-2019
Document status	Production Information	

Product status	Corresponding content status	
In Development / Prototype	Objective Specification	Target values. Revised and supplementary data will be published later.
Engineering Sample	Advance Information	Data based on early testing. Revised and supplementary data will be published later.
Initial Production	Early Production Information	Data from product verification. Revised and supplementary data may be published later.
Mass Production / End of Life	Production Information	Document contains the final product specification.

This document applies to the following products:

Product name	Type number	ROM/FLASH version	PCN reference
ZOE-M8G	ZOE-M8G-0-10	ROM SPG 3.01 / FLASH FW SPG 3.01	N/A
ZOE-M8Q	ZOE-M8Q-0-10	ROM SPG 3.01 / FLASH FW SPG 3.01	N/A

u-blox or third parties may hold intellectual property rights in the products, names, logos and designs included in this document. Copying, reproduction, modification or disclosure to third parties of this document or any part thereof is only permitted with the express written permission of u-blox.

The information contained herein is provided "as is" and u-blox assumes no liability for its use. No warranty, either express or implied, is given, including but not limited to, with respect to the accuracy, correctness, reliability and fitness for a particular purpose of the information. This document may be revised by u-blox at any time without notice. For the most recent documents, visit www.u-blox.com.

Copyright © u-blox AG.

Contents

Document Information	2
Contents	3
1 Functional description	5
1.1 Overview	5
1.2 Product features	5
1.3 GNSS performance	6
1.4 Block diagram	7
1.5 Supported GNSS constellations	7
1.5.1 GPS	7
1.5.2 GLONASS	8
1.5.3 BeiDou	8
1.5.4 Galileo	8
1.6 Assisted GNSS (A-GNSS).....	8
1.6.1 AssistNow™ Online.....	8
1.6.2 AssistNow™ Offline.....	9
1.6.3 AssistNow™ Autonomous	9
1.7 Augmentation systems	9
1.7.1 Satellite-Based Augmentation System (SBAS)	9
1.7.2 QZSS	9
1.7.3 IMES	10
1.7.4 Differential GPS (D-GPS).....	10
1.8 Broadcast navigation data and satellite signal measurements	10
1.9 Odometer	10
1.10 Data logging	10
1.11 Geofencing.....	11
1.12 Message integrity protection	11
1.13 Spoofing detection	11
1.14 EXTINT: External interrupt.....	11
1.1.1 Pin control	11
1.1.2 Aiding	11
1.15 TIMEPULSE	12
1.16 Protocols and interfaces	12
1.17 Interfaces.....	12
1.17.1 UART	12
1.17.2 SPI	12
1.17.3 Display Data Channel (DDC)	12
1.17.4 Serial Quad Interface (SQI)	13
1.17.5 Interface selection (D_SEL)	13
1.18 Configurable Input Output pins	13
1.19 Safe Boot Mode	13

1.20 System reset.....	13
1.21 Clock generation.....	13
1.21.1 Oscillator.....	13
1.21.2 Real-Time Clock (RTC).....	14
1.22 Power management	14
1.22.1 DC/DC converter (optional and only on ZOE-M8Q).....	14
1.22.2 Operating modes	14
1.23 Antenna.....	15
2 Pin definition	16
2.1 Pin assignment.....	16
3 Electrical specification	19
3.1 Absolute maximum rating.....	19
3.2 Operating conditions.....	19
3.2.1 DC electrical characteristic	20
3.2.2 Baseband parameters	20
3.3 Indicative power requirements.....	21
3.4 SPI timing diagrams	21
3.4.1 Timing recommendations.....	22
4 Mechanical specification	23
5 Reliability tests and approvals.....	24
5.1 Reliability tests.....	24
5.2 Approvals.....	24
6 Product handling.....	25
6.1 Packaging	25
6.1.1 Reels	25
6.1.2 Tapes.....	25
6.2 Shipment, storage and handling	26
6.3 Moisture sensitivity levels.....	26
6.4 Reflow soldering	26
6.5 ESD handling precautions.....	26
7 Default messages	27
8 Labeling and ordering information	28
8.1 Product labeling.....	28
8.2 Explanation of product codes.....	28
8.3 Ordering codes.....	28
8.4 Date code and lot number	29
8.5 Pin 1 marking	29
Related documents	30
Revision history	30
Contact.....	31

1 Functional description

1.1 Overview

The ZOE-M8G and ZOE-M8Q are u-blox’s super small, highly integrated GNSS SiP (System in Package) modules based on the high performing u-blox M8 concurrent positioning engine. The ultra-miniature form factor integrates a complete GNSS receiver including SAW filter, LNA and TCXO. ZOE-M8G is the 1.8 V variant, and ZOE-M8Q is the 3 V variant.

ZOE-M8 SiPs are mainly targeted for applications that require a small size without compromising performance. For RF optimization, the ZOE-M8 SiPs integrate a front-end SAW filter and an additional front-end LNA for increased jamming immunity and easier antenna integration. A passive antenna can be used to provide a highly integrated system solution with minimal eBOM.

Incorporating ZOE-M8 into customer designs is simple and straightforward, thanks to the fully integrated design, single voltage supply, low power consumption, simple interface and sophisticated interference suppression that ensure maximum performance even in GNSS-hostile environments.

With its dual-frequency RF front-end, the ZOE-M8 GNSS SiPs are able to utilize concurrent reception of up to three GNSS systems (GPS / Galileo together with BeiDou or GLONASS). In addition, the ZOE-M8 SiPs provide SPI interface for optional external Flash, allowing future firmware upgrades and improved A-GNSS performance.

Thanks to u-blox’s advanced algorithms and complete GNSS solution, the ZOE-M8 SiPs meet even the most stringent requirements in versatile industrial and consumer applications, such as UAVs, vehicles and assets tracking. It also supports message integrity protection, anti-jamming, and anti-spoofing, providing reliable positioning in difficult environmental conditions as well as in security attack scenarios.

The ZOE-M8 SiPs can be easily integrated in manufacturing thanks to the advanced S-LGA (Soldered Land Grid Array) packaging technology, which enables easier and more reliable soldering processes compared to a normal LGA (Land Grid Array) package.

The ZOE-M8 SiPs are fully tested and qualified according to the JESD47 / ISO 16750 standard.

1.2 Product features

Model	Category	GNSS	Supply	Interfaces	Features	Grade
	Standard Precision GNSS High Precision GNSS Dead Reckoning Timing	GPS / QZSS GLONASS Galileo BeiDou Number of concurrent GNSS	1.71 V – 1.89 V 2.7 V – 3.6 V	UART USB SPI DDC (I ² C compliant)	Programmable (Flash) Data logging Additional SAW Additional LNA RTC crystal Oscillator Built-in antenna Timepulse	Standard Professional Automotive
ZOE-M8G	•	• • • • 3	•	• • • •	• • o T	•
ZOE-M8Q	•	• • • • 3	•	• • • •	• • o T	•

E = External Flash required o = Optional, or requires external components C= Crystal / T = TCXO

1.3 GNSS performance

Parameter	Specification					
Receiver type	72-channel u-blox M8 engine GPS L1C/A, SBAS L1C/A, QZSS L1C/A, QZSS L1 SAIF, GLONASS L1OF, BeiDou B1I, Galileo E1B/C					
Accuracy of time pulse signal	RMS	30 ns				
	99%	60 ns				
Frequency of time pulse signal	0.25 Hz to 10 MHz (configurable)					
Operational limits ¹	Dynamics	≤ 4 g				
	Altitude	50,000 m				
	Velocity	500 m/s				
Velocity accuracy ²	0.05 m/s					
Heading accuracy ²	0.3 degrees					
Horizontal position accuracy ³	GNSS	GPS & GLONASS	GPS	GLONASS	BeiDou	Galileo
		2.5 m	2.5 m	4 m	3 m	TBC ⁴
Max navigation update rate	ROM	10 Hz	18 Hz	18 Hz	18 Hz	18 Hz
	Flash	5 Hz	10 Hz	10 Hz	10 Hz	10 Hz
Time-To-First-Fix ⁵	Cold start	26 s	29 s	30 s	34 s	45 s
	Hot start	1 s	1 s	1 s	1 s	1 s
	Aided starts ⁶	2 s	2 s	2 s	3 s	7 s
Sensitivity ⁷	Tracking & Navigation	-167 dBm	-166 dBm	-166 dBm	-160 dBm	-159 dBm
	Reacquisition	-160 dBm	-160 dBm	-156 dBm	-157 dBm	-153 dBm
	Cold start	-148 dBm	-148 dBm	-145 dBm	-143 dBm	-138 dBm
	Hot start	-157 dBm	-157 dBm	-156 dBm	-155 dBm	-151 dBm

Table 1: ZOE-M8 performance in different GNSS modes (default: concurrent reception of GPS and GLONASS)

¹ Assuming Airborne < 4 g platform

² 50% @ 30 m/s

³ CEP, 50%, 24 hours static, -130 dBm, > 6 SVs

⁴ To be confirmed when Galileo reaches full operational capability

⁵ All satellites at -130 dBm, except Galileo at -127 dBm

⁶ Dependent on aiding data connection speed and latency

⁷ Demonstrated with a good external LNA

1.4 Block diagram

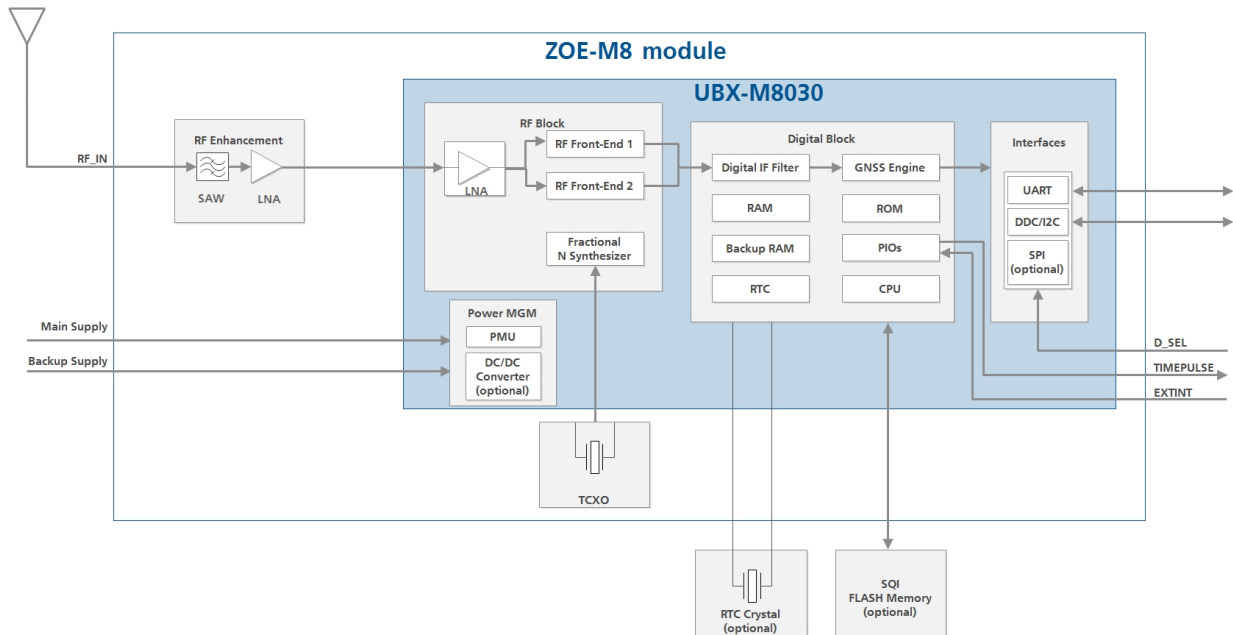

Figure 1: ZOE-M8 block diagram

1.5 Supported GNSS constellations

ZOE-M8 GNSS SiPs are concurrent GNSS receivers which can receive and track multiple GNSS systems: GPS, Galileo, GLONASS and BeiDou. Owing to the dual-frequency RF front-end architecture, either GLONASS or BeiDou can be processed concurrently with GPS and Galileo signals, thereby providing reception of three GNSS systems. By default, the M8 receivers are configured for concurrent GPS and GLONASS, including SBAS and QZSS reception. If power consumption is a key factor, then the receiver should be configured for a single GNSS operation using GPS, Galileo, GLONASS or BeiDou and disabling QZSS and SBAS. The ZOE-M8 SiPs can be configured to receive any single GNSS constellation or any one combination from the set of permissible combinations shown below.

GPS	Galileo	GLONASS	BeiDou
•	•	–	–
•	•	•	–
•	•	–	•
•	–	•	–
•	–	–	•
–	•	•	–
–	•	–	•
–	–	•	•

Table 2: Permissible GNSS combinations (• = enabled)

The augmentation systems: SBAS and QZSS can be enabled only if GPS operation is configured.

Galileo is not enabled as the default configuration.

1.5.1 GPS

The ZOE-M8 positioning SiPs are designed to receive and track the L1C/A signals provided at 1575.42 MHz by the Global Positioning System.

1.5.2 GLONASS

The ZOE-M8 SiPs can receive and process the GLONASS satellite system as an alternative to the US-based Global Positioning System (GPS). The u-blox ZOE-M8 positioning SiPs are designed to receive and track the L1OF signals that GLONASS provides at $1602 \text{ MHz} + k \cdot 562.5 \text{ kHz}$, where k is the satellite's frequency channel number ($k = -7, \dots, 5, 6$). The ability to receive and track GLONASS L1OF satellite signals allows the design of GLONASS receivers where required by regulations.

To take advantage of GPS and GLONASS, dedicated hardware preparation must be made during the design-in phase. See the *ZOE-M8 Hardware Integration Manual* [1] for u-blox design recommendations.

1.5.3 BeiDou

The ZOE-M8 SiPs can receive and process the B1I signals that are broadcast at 1561.098 MHz from the BeiDou Navigation Satellite System. The ability to receive and track BeiDou signals in conjunction with another constellation results in higher coverage, improved reliability and better accuracy. Currently, BeiDou is not fully operational globally and provides Chinese regional coverage only. Global coverage is scheduled for 2020.

1.5.4 Galileo

The ZOE-M8 SiPs can receive and track the E1-B/C signals centered on the GPS L1 frequency band. GPS and Galileo signals can be processed concurrently together with either BeiDou or GLONASS signals, which enhances coverage, reliability and accuracy. The SAR return link message (RLM) parameters for both short and long versions are decoded by the receiver and made available to users via UBX proprietary messages.

 Galileo has been implemented according to ICD release 1.3 (December 2016). Since the Galileo satellite system has only recently reached Initial Services (IS) and has not yet reached Full Operational Capability (FOC), changes to the Galileo signal specification (OS SIS ICD) remain theoretically possible. u-blox therefore recommends the use of Flash memory in designs that utilize Galileo signals, in order to allow for a firmware update in the unlikely event of a change to the Galileo signal specification (OS SIS ICD).

 Galileo reception is by default disabled, but can be enabled by sending a configuration message (UBX-CFG-GNSS) to the receiver. See the *u-blox 8 / u-blox M8 Receiver Description Including Protocol Specification* [2] for more information.

1.6 Assisted GNSS (A-GNSS)

Supply of GNSS receiver assistance information, such as ephemeris, almanac, rough user position and time, will reduce the time to first fix significantly and improve acquisition sensitivity. All u-blox M8030 based products support the u-blox AssistNow Online and AssistNow Offline A-GNSS services, support AssistNow Autonomous, and are OMA SUPL compliant.

1.6.1 AssistNow™ Online

With AssistNow Online, an Internet connected host downloads assistance data from the u-blox AssistNow Online service to the receiver at system start-up. The Multi-GNSS Assistance (MGA) service is an HTTP protocol based network operator independent service.

Supplying assistance information, such as ephemeris, almanac, a rough last position and time, can reduce the time to first fix significantly and improve acquisition sensitivity.

 The AssistNow Online service provides data for GPS, GLONASS, BeiDou, Galileo and QZSS

1.6.2 AssistNow™ Offline

With the AssistNow Offline service, users can download long-term orbit data over the Internet at their convenience. The orbit data can be stored in the memory of the application processor or alternatively external SMI flash memory (if available). The function requires no connectivity at system start-up, enabling a position fix within seconds, even when no network is available. AssistNow Offline offers augmentation for up to 35 days.

 AssistNow Offline service provides data for GPS and GLONASS only, BeiDou and Galileo are not currently supported

1.6.3 AssistNow™ Autonomous

AssistNow Autonomous provides aiding information without the need for a host or external network connection. Based on previous broadcast satellite ephemeris data downloaded to and stored by the GNSS receiver, AssistNow Autonomous automatically generates accurate predictions of satellite orbital data (“AssistNow Autonomous data”) that is usable for future GNSS position fixes. The concept capitalizes on the periodic nature of GNSS satellites; by capturing strategic ephemeris data at specific times of the day.

u-blox’s AssistNow Autonomous benefits are:

- Faster fix in situations where GNSS satellite signals are weak
- No connectivity required
- Compatible with AssistNow Online (can work stand-alone, or in tandem with AssistNow Online service)
- No integration effort; calculations are done in the background, transparent to the user.

 The ZOE-M8 SiPs utilizing external Flash can predict accurate satellite ephemeris for up to six days after initial reception. The ROM based ZOE-M8 can use only GPS satellites with a prediction time of up to three days.

 For more information on A-GNSS, see the *u-blox 8 / u-blox M8 Receiver Description Including Protocol Specification [2]*.

1.7 Augmentation systems

1.7.1 Satellite-Based Augmentation System (SBAS)

The u-blox ZOE-M8 SiPs support reception of SBAS broadcast signals. These systems supplement GNSS data with additional regional or wide area GPS augmentation data. The system broadcasts range correction and integrity information via satellite which can be used by GNSS receivers to improve resulting precision. SBAS satellites can be used as additional satellites for ranging (navigation), further enhancing availability. The following SBAS types are supported: GAGAN, WAAS, EGNOS and MSAS.

 For more details see the *u-blox 8 / u-blox M8 Receiver Description Including Protocol Specification [2]*.

1.7.2 QZSS

The Quasi-Zenith Satellite System (QZSS) is a regional navigation satellite system that transmits additional GPS L1C/A signals for the Pacific region covering Japan and Australia. The ZOE-M8 SiPs are able to receive and track these signals concurrently with GPS signals, resulting in better availability especially under challenging signal conditions, e.g. in urban canyons. The L1-SAIF signal provided by QZSS can be enabled for reception via a GNSS configuration message.

1.7.3 IMES

The Japanese Indoor Messaging System (IMES) system is used for indoor position reporting using low-power transmitters which broadcast a GPS-like signal. The ZOE-M8 SiPs can be configured to receive and demodulate the signal to provide an in-door location estimate.

 This service is authorized and available only in Japan.

 IMES reception is disabled by default

1.7.4 Differential GPS (D-GPS)

u-blox ZOE-M8 SiPs support Differential-GPS (D-GPS) data according to RTCM specification 10402.3 [4]: "RECOMMENDED STANDARDS FOR DIFFERENTIAL GNSS". The use of Differential-GPS data improves GPS position accuracy. The RTCM implementation supports the following RTCM 2.3 messages:

Message Type	Description
1	Differential GPS Corrections
2	Delta Differential GPS Corrections
3	GPS Reference Station Parameters
9	GPS Partial Correction Set

Table 3: Supported RTCM 2.3 messages

 RTCM corrections cannot be used together with SBAS.

 For more details, see the u-blox 8 / u-blox M8 Receiver Description Including Protocol Specification [2].

1.8 Broadcast navigation data and satellite signal measurements

The ZOE-M8 SiPs can output all the GNSS broadcast data upon reception from tracked satellites. This includes all the supported GNSS signals plus the augmentation services SBAS, QZSS and IMES. The receiver also makes the tracked satellite signal information available, i.e. raw code phase and Doppler measurements, in a form aligned to the Radio Resource LCS Protocol (RRLP) [5]. For more details, see the u-blox 8 / u-blox M8 Receiver Description Including Protocol Specification [2].

1.9 Odometer

The odometer function provides information on travelled ground distance (in meters) based on the position and Doppler-based velocity output from the navigation solution. For each computed distance since the last odometer reset, the odometer estimates a 1-sigma accuracy value. The total cumulative ground distance is maintained and saved in the BBR memory.

 The odometer feature is disabled by default. For more details, see the u-blox 8 / u-blox M8 Receiver Description Including Protocol Specification [2].

1.10 Data logging

A ZOE-M8 SiP can be used in data logging applications with an external SQI flash. The data logging feature enables continuous storage of position, velocity and time information to the SQI flash memory (at least 16 Mbit). The information can be downloaded from the receiver later for further analysis or for conversion to a mapping tool.

 For more information, see the *u-blox 8 / u-blox M8 Receiver Description Including Protocol Specification [2]*.

1.11 Geofencing

ZOE-M8 SiPs support up to four circular geofencing areas defined on the Earth's surface using a 2D model. Geofencing is active when at least one geofence is defined; the current status can be found by polling the receiver. A GPIO pin can be used to indicate status, e.g. to wake up a host on activation.

1.12 Message integrity protection

ZOE-M8 SiPs provide a function to detect third party interference with the UBX message stream sent from receiver to host. The security mechanism “signs” nominated messages via a subsequent UBX message. This message signature is then compared with one generated by the host to determine if the message data has been altered. The signature algorithm seed can use one fixed secret ID-key set by eFuse in production and a dynamic ID-key set by the host, enabling users to detect “man-in-the-middle” style attacks.

1.13 Spoofing detection

Spoofing is a process whereby a malicious third party tries to control the reported position via a fake GNSS broadcast signal. This may result in the form of reporting incorrect position, velocity or time. To combat against this, the ZOE-M8 SiPs include spoofing detection measures to alert the host when signals appear to be suspicious. The receiver combines a number of checks on the received signals looking for inconsistencies across several parameters.

 This feature does not guarantee to detect all spoofing attacks.

1.14 EXTINT: External interrupt

EXTINT is an external interrupt pin with fixed input voltage thresholds with respect to **VCC**. It can be used for control of the receiver or for aiding.

For more information about how to implement and configure these features, see the *u-blox 8 / u-blox M8 Receiver Description including Protocol Specification [2]* and the *ZOE-M8 Hardware Integration Manual[1]*.

1.1.1 Pin control

The pin control feature allows overriding the automatic active/inactive cycle of power save mode. The state of the receiver can be controlled through the **EXTINT** pin.

The receiver can also be forced OFF using **EXTINT** when power save mode is not active.

1.1.2 Aiding

The **EXTINT** pin can be used to supply time or frequency aiding data to the receiver.

For time aiding, the time can be supplied using hardware time synchronization where an accurate time pulse is connected to the **EXTINT** pin.

Frequency aiding can be implemented by connecting a periodic rectangular signal with a frequency up to 500 kHz and arbitrary duty cycle (low/high phase duration must not be shorter than 50 ns) to the **EXTINT** pin, and providing the applied frequency value to the receiver using UBX messages.

1.15 TIMEPULSE

A configurable time pulse signal is available with u-blox ZOE-M8 SiPs.

The **TIMEPULSE** output generates pulse trains synchronized with GPS or UTC time grid with intervals configurable over a wide frequency range. Thus it may be used as a low frequency time synchronization pulse or as a high frequency reference signal.

By default the time pulse signal is configured to 1 pulse per second. For more information see the *u-blox 8 / u-blox M8 Receiver Description including Protocol Specification* [2].

1.16 Protocols and interfaces

Protocol	Type
NMEA	Input/output, ASCII, 0183, version 4.0 (configurable to V2.1, V2.3 or V4.1)
UBX	Input/output, binary, u-blox proprietary
RTCM	Input, messages 1, 2, 3, 9

Table 4: Available Protocols

All protocols are available on UART, DDC (I²C compliant) and SPI. For the specifications of the various protocols, see the *u-blox 8 / u-blox M8 Receiver Description Including Protocol Specification* [2].

1.17 Interfaces

A number of interfaces are provided either for data communication or memory access. The embedded firmware uses these interfaces according to their respective protocol specifications.

1.17.1 UART

The ZOE-M8 SiPs make use of a UART interface, which can be used for communication to a host. It supports configurable baud rates. For supported transfer rates, see the *u-blox 8 / u-blox M8 Receiver Description Including Protocol Specification* [2].

 Designs must allow access to the UART and the **SAFEBOOT_N** pin for future service, updates and reconfiguration.

1.17.2 SPI

The SPI interface is designed to allow communication to a host CPU. The interface can be operated in slave mode only. The maximum transfer rate using SPI is 125 kB/s and the maximum SPI clock frequency is 5.5 MHz. Note that SPI is not available in the default configuration, because its pins are shared with the UART and DDC interfaces. The SPI interface can be enabled by connecting **D_SEL** to ground (see section 1.17.5). In this case the DDC interface for data communication is no longer available.

1.17.3 Display Data Channel (DDC)

An I²C compliant DDC interface is available for communication with an external host CPU or u-blox cellular module. The interface can be operated in slave mode only. The DDC protocol and electrical interface are fully compatible with Fast-Mode of the I²C industry standard. Since the maximum SCL clock frequency is 400 kHz, thus the maximum transfer rate is 400 kb/s.

The DDC interface is I²C Fast Mode compliant. For timing parameters, consult the I²C standard.

 The maximum bit rate is 400 kb/s. The interface stretches the clock when slowed down while serving interrupts, so real bit rates may be slightly lower.

1.17.4 Serial Quad Interface (SQI)

An SQI is available in ZOE-M8 SiPs for connecting with an optional external flash memory. The flash memory is required for firmware updates and for data logging. In addition, it can be used to store configurations and to save AssistNow Offline and AssistNow Autonomous data.

For more information, see the ZOE-M8 Hardware Integration Manual [1].

1.17.5 Interface selection (D_SEL)

At startup the **D_SEL** pin determines which data interfaces are used for communication. If **D_SEL** is set to logical “1” or is not connected, UART and DDC become available. If **D_SEL** is set to logical “0”, i.e. connected to **GND**, the ZOE-M8 SiPs can communicate to a host via SPI.

Pin #	(D_SEL)=“1” (left open)	(D_SEL)=“0” (connected to GND)
J5	UART TX	SPI MISO
J4	UART RX	SPI MOSI
B1	DDC SCL	SPI CLK
A2	DDC SDA	SPI CS_N

Table 5: Data interface selection by D_SEL

1.18 Configurable Input Output pins

Configuration settings can be modified for several Input/Output pins with either UBX configuration messages or pin selection. This flexible configuration options allow the receivers to be optimally configured for specific applications requirements. The modified settings remain either permanent or effective until power-down or reset depending on the case. Customers can activate or remap the following pins on ZOE-M8 SiPs:

- Selection of DDC, UART TX/RX pins interface or SPI using **D_SEL** pin. See section 1.17.5.
- Selection of external interrupt pins. See section 1.14.
- Configuration of Timepulse. See section 1.15.

For more information, see the ZOE-M8 Hardware Integration Manual [1].

1.19 Safe Boot Mode

If Pin C4 (**SAFEBOOT_N**) is set to logical “0” at startup, the ZOE-M8 receiver enters Safe Boot Mode. In this mode, the receiver does not calculate positioning data, but is in a defined state that allows such actions as programming the flash memory in production, or recovering a corrupted flash memory.

For more information about Safe Boot Mode, see the ZOE-M8 Hardware Integration Manual [1].

1.20 System reset

The ZOE-M8 SiPs provide a **RESET_N** pin to reset the system and Real-Time Clock (RTC). The **RESET_N** pin should be only used in critical situations to recover the system.

1.21 Clock generation

1.21.1 Oscillator

Both ZOE-M8 SiP variants have a TCXO. The TCXO allows accelerated weak signal acquisition, enabling faster start and reacquisition times.



1.21.2 Real-Time Clock (RTC)

The use of the RTC Clock may be optionally used to maintain time in the event of power failure at **VCC**. The RTC is required for hot start, warm start, AssistNow Autonomous, AssistNow Offline and some Power Save Mode operations.

The use of the RTC is optional. The time information can be generated in one of these ways:

- by connecting to an external RTC crystal (for lower battery current – default mode)
- by sharing another RTC oscillator used within the application (for lowest system costs and smallest size)

If the main supply voltage fails and a battery is connected to **V_BCKP**, parts of the baseband section switch off, but the RTC still runs, providing a timing reference for the receiver. This operating mode is called Hardware Backup Mode, which enables all relevant data to be saved in the backup RAM to later allow a hot or warm start.

-  See Table 12 for details of RTC voltage requirements when using an optional RTC.
-  For more information about crystal operation and configuration, see the *ZOE-M8 Hardware Integration Manual*[1].
-  If neither backup RAM nor RTC are used, the backup battery is not needed and **V_BCKP** should be connected to **VCC**.

1.22 Power management

u-blox ZOE-M8 SiPs offer a power-optimized architecture with built-in autonomous power saving functions to minimize power consumption at any given time. Furthermore, the receiver can be used in two operating modes: Continuous mode for best performance or Power Save Mode for optimized power consumption.

1.22.1 DC/DC converter (optional and only on ZOE-M8Q)

ZOE-M8Q has an option to make use of a high-efficient, built-in DC/DC converter to allow low power consumption. To use the DC/DC converter, a capacitor and an inductor must be added to connect **V_DCDC_OUT** to **V_CORE**.

If the built-in DC/DC converter is not used, **VCC**, **V_DCDC_OUT** and **V_CORE** need to be shorted.

-  For more information, see the *ZOE-M8 Hardware Integration Manual*[1].

1.22.2 Operating modes

u-blox ZOE-M8 SiPs can be configured to run in either continuous mode or a choice of power save mode configurations. A template of power mode settings can be used to easily select typical power mode setups to cover the majority of users' requirements.

For specific power saving applications the user has the option to fully configure via the power save mode configuration. More information see the section 1.22.2.2.

The ZOE-M8 SiP power mode setup offers a choice of continuous operation and preset power save mode configurations.

- Continuous (default) mode for best GNSS performance vs. power consumption
- Continuous with no compromise in power consumption
- A 1Hz cyclic tracking mode for aggressive power reduction

- Choice of 2 or 4 Hz⁸ cyclic tracking modes for typical wearable applications
- ON/OFF interval mode

1.22.2.1 Continuous mode

Continuous mode uses the acquisition engine at full performance resulting in the shortest possible TTFF and the highest sensitivity. It searches for all possible satellites until the Almanac is completely downloaded. The receiver then switches to the tracking engine to lower power consumption.



Thus, a lower tracking current consumption level will be achieved when:

- A valid GNSS position is obtained
- The entire Almanac has been downloaded
- The Ephemeris for each satellite in view is valid

1.22.2.2 Power save mode

For specific power saving applications outside the typical preset power mode setups, users can configure a tailored power save mode.

Power save mode provides two dedicated methods, ON/OFF and cyclic tracking, which reduce average current consumption in different ways to match the needs of the specific application. These operations can be set by using a specific UBX message.

-  For ON/OFF power save operation, an RTC signal is required.
-  Position accuracy in power save mode is degraded compared to continuous mode.
-  For more information about power management strategies, see the u-blox 8 / u-blox M8 Receiver Description Including Protocol Specification [2].

1.23 Antenna

The ZOE-M8 SiPs are designed for use with passive⁹ and active¹⁰ antennas.

Parameter	Specification	
Antenna Type	Passive and active antenna	
Active Antenna Recommendations	Minimum gain	10 dB (including cable loss)
	Maximum gain	30 dB
	Maximum noise figure	2 dB

Table 6: Antenna recommendations and specifications for ZOE-M8 SiPs

⁸ Single GNSS constellation configuration only

⁹ For integration ZOE-M8 SiPs with Cellular products, see the *ZOE-M8 Hardware Integration Manual*[1].

¹⁰ For information on using active antennas with ZOE-M8 SiPs, see the *ZOE-M8 Hardware Integration Manual*[1].

2 Pin definition

2.1 Pin assignment

This section shows the pin assignments. Most PIOs are configurable and have shared functions. Use special care when designing with these pins since the overall function of the device can be affected.

The default configuration of the PIOs is listed in Table 7 below.

For more information, see the *ZOE-M8 Hardware Integration Manual* [1].

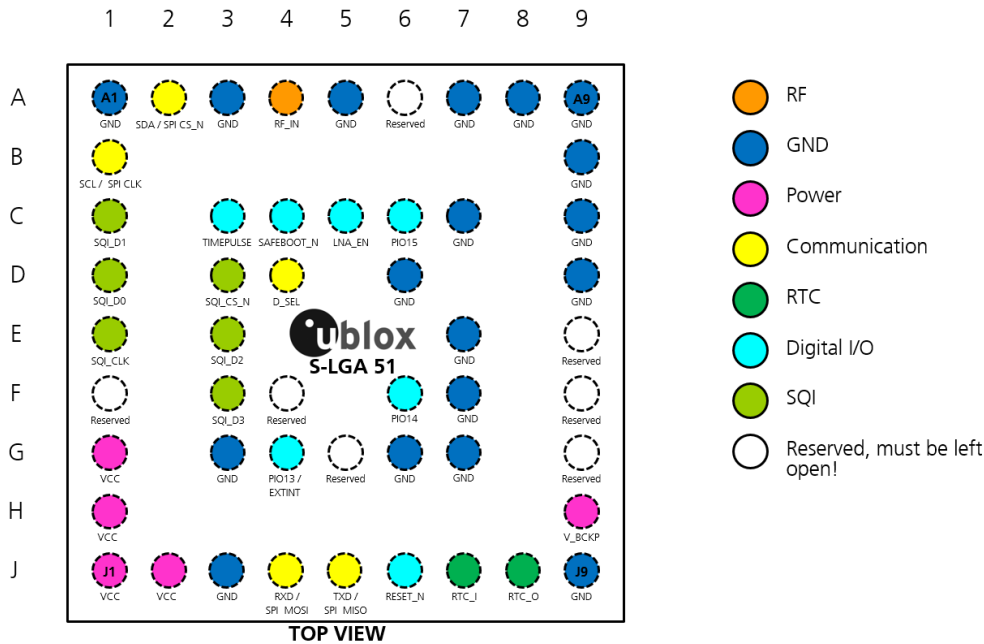

Figure 2: Pin assignment of ZOE-M8G (S-LGA51), top view

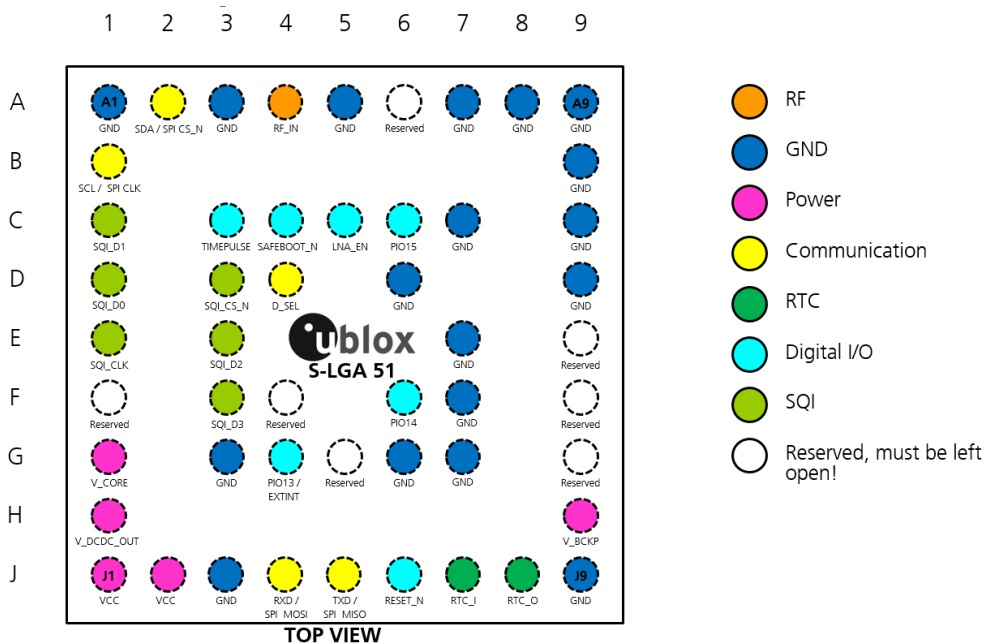

Figure 3: Pin assignment of ZOE-M8Q (S-LGA51), top view

For multiple function PIOs, select the specific signal by sending the specific configuration message.

Pin #	SiP	Name	I/O	Description	Remark
A1	All	GND		Ground	
A2	All	SDA / SPI CS_N	I/O	Serial interface. See section 1.17.5.	Leave open if not used.
A3	All	GND		Ground	
A4	All	RF_IN	I	GNSS signal input	
A5	All	GND		Ground	
A6	All	Reserved	I/O	Reserved.	Do not connect. Must be left open!
A7	All	GND		Ground	
A8	All	GND		Ground	
A9	All	GND		Ground	
B1	All	SCL / SPI CLK	I	Serial interface. See section 1.17.5.	Leave open if not used.
B9	All	GND		Ground	
C1	All	SQI_D1	I	Data line 1 to external SQI flash memory or reserved configuration pin.	Leave open if not used.
C3	All	TIMEPULSE	O	Time pulse output	Leave open if not used.
C4	All	SAFEBOOT_N	I	Used for programming the SQI flash memory and testing purposes.	Leave open if not used.
C5	All	LNA_EN	O	LNA on/off signal connected to internal LNA	Leave open if not used.
C6	All	PIO15	I/O	Digital I/O	Leave open if not used.
C7	All	GND		Ground	
C9	All	GND		Ground	
D1	All	SQI_D0	I/O	Data line 0 to external SQI flash memory or reserved configuration pin.	Leave open if not used.
D3	All	SQI_CS_N	I/O	Chip select for external SQI flash memory or configuration enable pin.	Leave open if not used.
D4	All	D_SEL	I	Interface selector	See section 1.17.5.
D6	All	GND		Ground	
D9	All	GND		Ground	
E1	All	SQI_CLK	I/O	Clock for external SQI flash memory or configuration pin.	Leave open if not used.
E3	All	SQI_D2	I/O	Data line 2 to external SQI flash memory or reserved configuration pin.	Leave open if not used.
E7	All	GND		Ground	
E9	All	Reserved	I/O	Reserved	Do not connect. Must be left open!
F1	All	Reserved	I/O	Reserved	Do not connect. Must be left open!
F3	All	SQI_D3	I/O	Data line 3 to external SQI flash memory or reserved configuration pin.	Leave open if not used.
F4	All	Reserved	I/O	Reserved	Do not connect. Must be left open!
F6	All	PIO14	I/O	Digital I/O	Leave open if not used.
F7	All	GND		Ground	
F9	All	Reserved	I/O	Reserved	Do not connect. Must be left open!
G1	ZOE-M8G	VCC	I	Supply voltage	Clean and stable supply needed
	ZOE-M8Q	V_CORE	I	Core Supply voltage	Connect to VCC if DCDC not used
G3	All	GND		Ground	

Pin #	SiP	Name	I/O	Description	Remark
G4	All	PIO13/EXTINT	I	External interrupt	Leave open if not used.
G5	All	Reserved	I/O	Reserved	Do not connect. Must be left open!
G6	All	GND		Ground	
G7	All	GND		Ground	
G9	All	Reserved	I/O	Reserved	Do not connect. Must be left open! Only exception is V_BCKP, which can be connected to this pin if not used.
H1	ZOE-M8G	VCC	I	Supply voltage	Clean and stable supply needed
	ZOE-M8Q	V_DCDC_OUT	O	DCDC converter output	Connect to VCC if DCDC not used
H9	All	V_BCKP	I	Backup supply	
J1	All	VCC	I	Supply voltage	Clean and stable supply needed
J2	All	VCC	I	Supply voltage	Clean and stable supply needed
J3	All	GND		Ground	
J4	All	RXD/SPI MOSI	I	Serial interface. See section 1.17.5.	Leave open if not used.
J5	All	TXD/SPI MISO	O	Serial interface. See section 1.17.5.	Leave open if not used.
J6	All	RESET_N	I	System reset. See section 1.20.	Leave open if not used.
J7	All	RTC_I	I	RTC Input	Connect to GND if no RTC Crystal attached.
J8	All	RTC_O	O	RTC Output	Leave open if no RTC Crystal attached.
J9	All	GND		Ground	

Table 7: ZOE-M8 pinout

For more information about the pinouts, see the ZOE-M8 Hardware Integration Manual [1].

3 Electrical specification

The limiting values given are in accordance with the Absolute Maximum Rating System (IEC 134). These are stress ratings only, and operation of the device at these or at any other conditions above those given in the Characteristics sections of the specification is not implied. Exposure to limiting values for extended periods may affect device reliability.

Where application information is given, it is advisory only and does not form part of the specification. For more information regarding power management, see the ZOE-M8 Hardware Integration Manual [1].

3.1 Absolute maximum rating

Symbol	SiP	Parameter	Min	Max	Unit
VCC	All	Supply voltage	-0.5	3.6	V
V_CORE	ZOE-M8Q	Core supply voltage	-0.5	3.6	V
V_DCDC_OUT	ZOE-M8Q	Output voltage of the internal DC/DC converter	-0.5	3.6	V
V_BCKP	All	Supply voltage baseband backup core	-0.5	3.6	V
V _{RTC}	All	Input voltage on RTC_I	-0.5	1.6	V
V _{DIG}	All	Input voltage on Configurable Inputs , RESET_N if VCC < 3.1 V	-0.5	VCC+0.5	V
		Input voltage on Configurable Inputs , RESET_N if VCC > 3.1 V		3.6	V
Pr _{fin}	All	RF Input power on RF_IN inband ¹¹		0	dBm
	All	RF Input power on RF_IN outband ¹²		+15	dBm
P _{tot}	All	Total power dissipation		500	mW
T _s	All	Storage temperature	-40	+85	°C

Table 8: Absolute maximum ratings

Stressing the device beyond the “Absolute Maximum Ratings” may cause permanent damage. These are stress ratings only. The product is not protected against overvoltage or reversed voltages. If necessary, voltage spikes exceeding the power supply voltage specification, given in table above, must be limited to values within the specified boundaries by using appropriate protection diodes.

3.2 Operating conditions

The test conditions specified in Table 9 apply to all characteristics defined in this section.

Symbol	Parameter	SiP	Min	Typical	Max	Unit	Remarks
T _{amb}	Ambient temperature	All	-40	+25	+85	°C	
GND	Ground	All		0		V	
VCC	Supply voltage	ZOE-M8G		1.8		V	
	Supply voltage	ZOE-M8Q		3.0		V	
V_CORE	Core supply voltage	ZOE-M8Q		3.0		V	
V_BCKP	Backup battery supply voltage	All		1.8		V	
NF _{tot}	Receiver Chain Noise Figure	All		2.5		dB	

Table 9: Test conditions

¹¹ Inband = 1525-1650 MHz

¹² Outband = 777-915 MHz, 1710-2200 MHz

All specifications are at an ambient temperature of 25°C. Extreme operating temperatures can significantly impact specification values. Applications operating near the temperature limits should be tested to ensure the specification.

3.2.1 DC electrical characteristic

For Power Management Unit (PMU) block diagrams, see the ZOE-M8 Hardware Integration Manual [1].

Symbol	Parameter	SiP	Min	Typ.	Max	Unit
V_BCKP	Input voltage for backup supply	All	1.4		3.6	V
V_CORE	Core supply voltage	ZOE-M8Q	1.4		3.6	V
VCC ¹³	Supply voltage	ZOE-M8G	1.71		1.89	V
	Supply voltage	ZOE-M8Q	2.7		3.6	V

Table 10: Power supply pins

Symbol	Parameter	Condition	Min	Typ.	Max	Unit
Ileak	Leakage current input pins			< 1		nA
Vil	Low level input voltage		0		0.2*VCC	V
Vih	High level input voltage		0.7*VCC		VCC+0.5	V
Vol	Low level output voltage for TXD/SPI MISO, RXD/SPI MOSI , SDA/SPI CS_N, SCL/SPI CLK , D_SEL, TIMEPULSE, PIO13/EXTINT, PIO14, PIO15, LNA_EN	I _{ol} = 4 mA			0.4	V
Voh	High level output voltage for TXD/SPI MISO, RXD/SPI MOSI , SDA/SPI CS_N, SCL/SPI CLK , D_SEL, TIMEPULSE, PIO13/EXTINT, PIO14, PIO15, LNA_EN	I _{oh} = 4 mA	VCC-0.4			V
Rpu	Pull-up resistor for SDA/SPI CS_N, SCL/SPI CLK , TIMEPULSE, PIO13/EXTINT, PIO14, RESET_N			11		kΩ
Rpu	Pull-up resistor for TXD/SPI MISO, RXD/SPI MOSI, PIO15, D_SEL			115		kΩ

Table 11: Digital I/O pins

3.2.2 Baseband parameters

Symbol	Parameter	SiP	Condition	Min.	Typ.	Max.	Unit
RTC_Fxtal	RTC crystal resonant frequency	All			32768		Hz
RTC_T_start	RTC startup time	All		0.2	0.35	0.9	sec
RTC_Amp	32768 Hz OSC oscillation amplitude	All		50		350	mVpp
RTC_ESR	32768 Hz Xtal equivalent series resistance	All				100	kΩ
RTC_CL	RTC integrated load capacitance	All	ESR = 80 kΩ	4	7	12	pF
DCDC_eff	DC/DC efficiency	ZOE-M8Q	3.3 V @ input, 4 mA – 80 mA, External components: L = 2.2 μH, C = 4.7 μF		85		%
V_DCDC_out	DC/DC output voltage	ZOE-M8Q	DC/DC enabled		1.4		V

Table 12: Baseband parameters

¹³ Max 50 mVpp ripple

3.3 Indicative power requirements

Table 13 lists examples of the total system supply current for a possible application.

The values in Table 13 are provided for customer information only as an example of typical current requirements. The values are characterized on samples; actual power requirements can vary depending on firmware version used, external circuitry, number of SVs tracked, signal strength, type of start as well as time, duration and conditions of test.

Parameter	Symbol	SiP	Typ GPS & GLONASS	Typ GPS / QZSS / SBAS	Max	Units	Condition
Max. supply current ¹⁴	I _{ccp}	All			67	mA	
Average supply current ¹⁵	I _{cc Acquisition} ¹⁶	ZOE-M8G	45	34.5		mA	Estimated at 1.8 V
		ZOE-M8Q	28	22		mA	Estimated at 3 V w/ DC/DC
		ZOE-M8Q	45	34.5		mA	Estimated at 3 V w/o DC/DC
	I _{cc Tracking} (Continuous mode)	ZOE-M8G	40	32.5		mA	Estimated at 1.8 V
		ZOE-M8Q	25	21		mA	Estimated at 3 V w/ DC/DC
		ZOE-M8Q	40	32.5		mA	Estimated at 3 V w/o DC/DC
	I _{cc Tracking} (Power Save mode / 1 Hz)	ZOE-M8G	12.5	11.5		mA	Estimated at 1.8 V
		ZOE-M8Q	9.0	8.5		mA	Estimated at 3 V w/ DC/DC
		ZOE-M8Q	12.5	11.5		mA	Estimated at 3 V w/o DC/DC
Backup battery current ¹⁷	I _{BCKP}	All	15			μA	HW Backup mode, VCC = 0 V, V _{BCKP} = 3 V using the RTC crystal
SW Backup current	I _{SWBCKP}	All	20			μA	SW Backup mode, VCC = 1.8 V (ZOE-M8G) VCC = 3.0 V (ZOE-M8Q) using the RTC crystal

Table 13: Currents to calculate the indicative power requirements

For more information about power requirements, see the ZOE-M8 Hardware Integration Manual [1].

All values in Table 13 are measured at +25 °C ambient temperature.

3.4 SPI timing diagrams

In order to avoid incorrect operation of the SPI, the user needs to comply with certain timing conditions. The following signals need to be considered for timing constraints:

Symbol	Description
SPI CS_N (SS_N)	Slave select signal
SPI CLK (SCK)	Slave clock signal

Table 14: Symbol description

¹⁴ Use this figure to dimension maximum current capability of power supply. Measurement of this parameter with 1 Hz bandwidth.

¹⁵ Simulated constellation of 8 satellites is used. All signals are at -130 dBm.

¹⁶ Average current from start-up until the first fix.

¹⁷ Use this figure to determine required battery capacity.

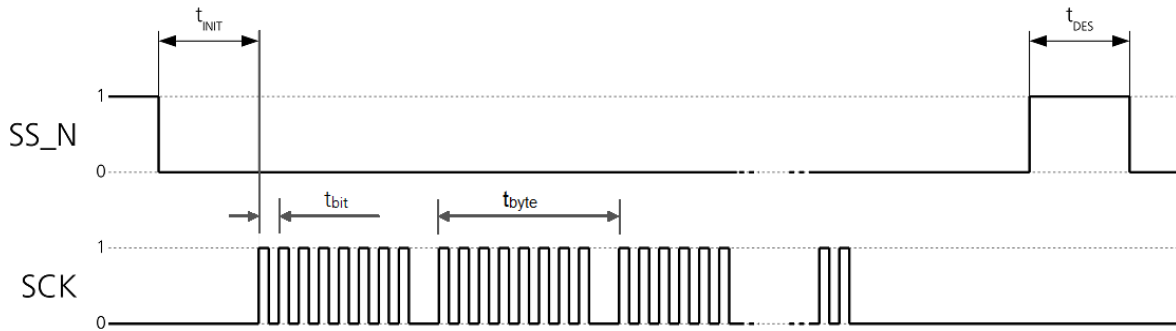



Figure 4: SPI timing diagram

3.4.1 Timing recommendations

The recommendations below are based on a firmware running from SQI flash memory.

Parameter	Description	Recommendation
t_{INIT}	Minimum Initialization Time	10 μ s
t_{DES}	Deselect Time	1 ms
t_{bit}	Minimum bit time	180 ns (5.5 MHz max bit frequency)
t_{byte}	Minimum byte period	8 μ s (125 kHz max byte frequency)

Table 15: SPI timing recommendations

 The values in the above table result from the requirement of an error-free transmission. By allowing just a few errors and disabling the glitch filter, the bit rate can be increased considerably.

4 Mechanical specification

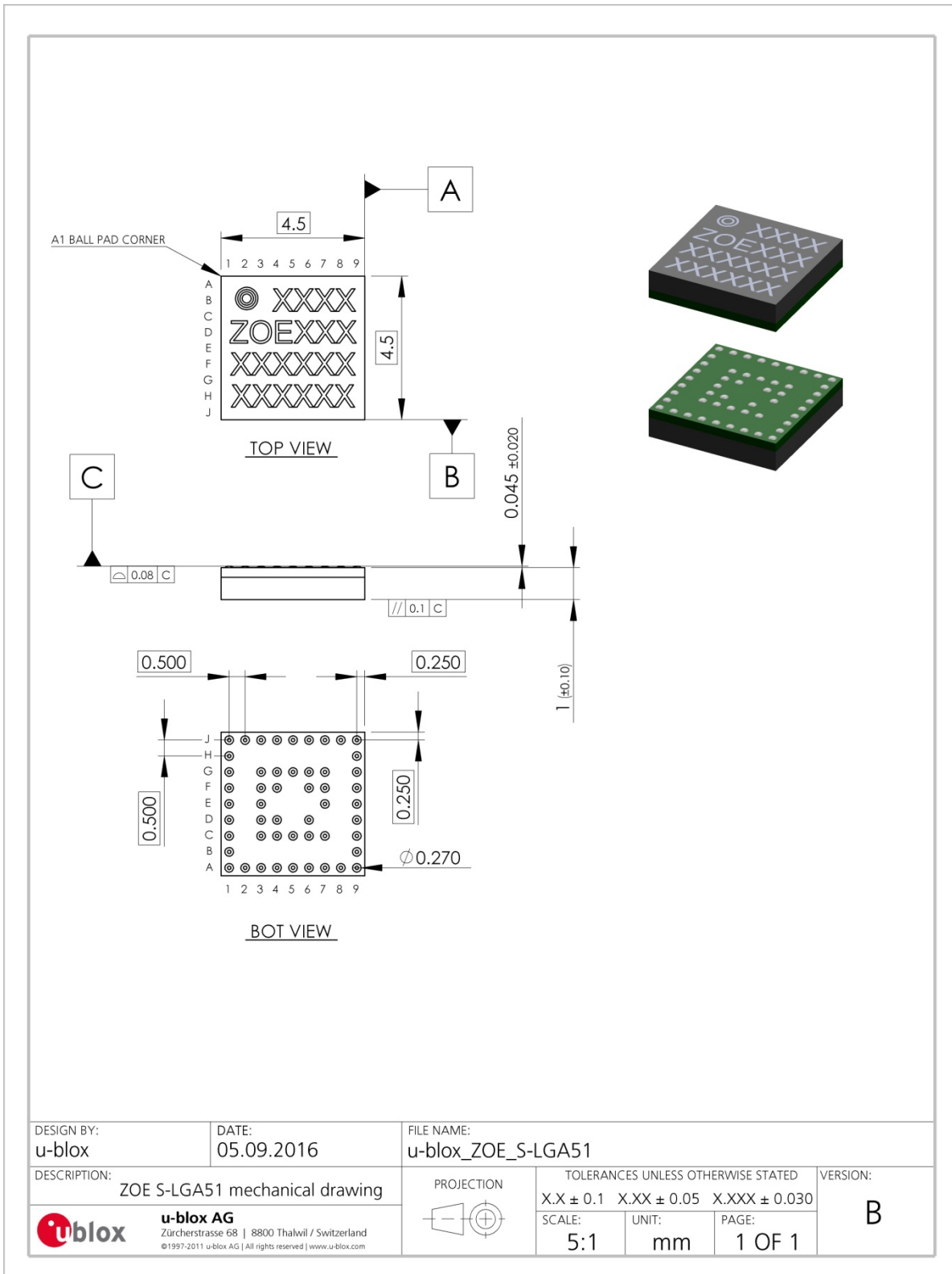

Figure 5: Mechanical drawing for ZOE-M8 (S-LGA), bottom view

5 Reliability tests and approvals

5.1 Reliability tests

 ZOE-M8 SiPs are based on AEC-Q100 qualified GNSS chips.

Qualification requirements are according to JEDEC standards JESD47 "*Stress-Test-Driven Qualification of Integrated Circuits*" and ISO 16750 "Road vehicles – environmental conditions and testing for electrical and electronic equipment".

5.2 Approvals



The ZOE-M8G and ZOE-M8Q SiPs comply with the Directives 2011/65/EU and 2015/863/EU of the European Parliament and the Council on the Restriction of Use of certain Hazardous Substances (RoHS).

6 Product handling

6.1 Packaging

ZOE-M8 SiPs are delivered as hermetically sealed, reeled tapes in order to enable efficient production lot set-up and tear-down. For more information about packaging, see the *u-blox Package Information Guide* [3].

6.1.1 Reels

ZOE-M8 SiPs are deliverable in quantities of 1000 pieces on a reel. The ZOE-M8 SiPs are shipped on Reel Type D, as described in the *u-blox Package Information Guide* [3].

6.1.2 Tapes

Figure 6 shows the feed direction and the orientation of the ZOE-M8 positioning SiPs on the tape. The positioning SiPs are placed such that the pin 1 is at the upper right for the S-LGA51 (Soldered LGA). The dimensions of the tapes are specified in Figure 6.

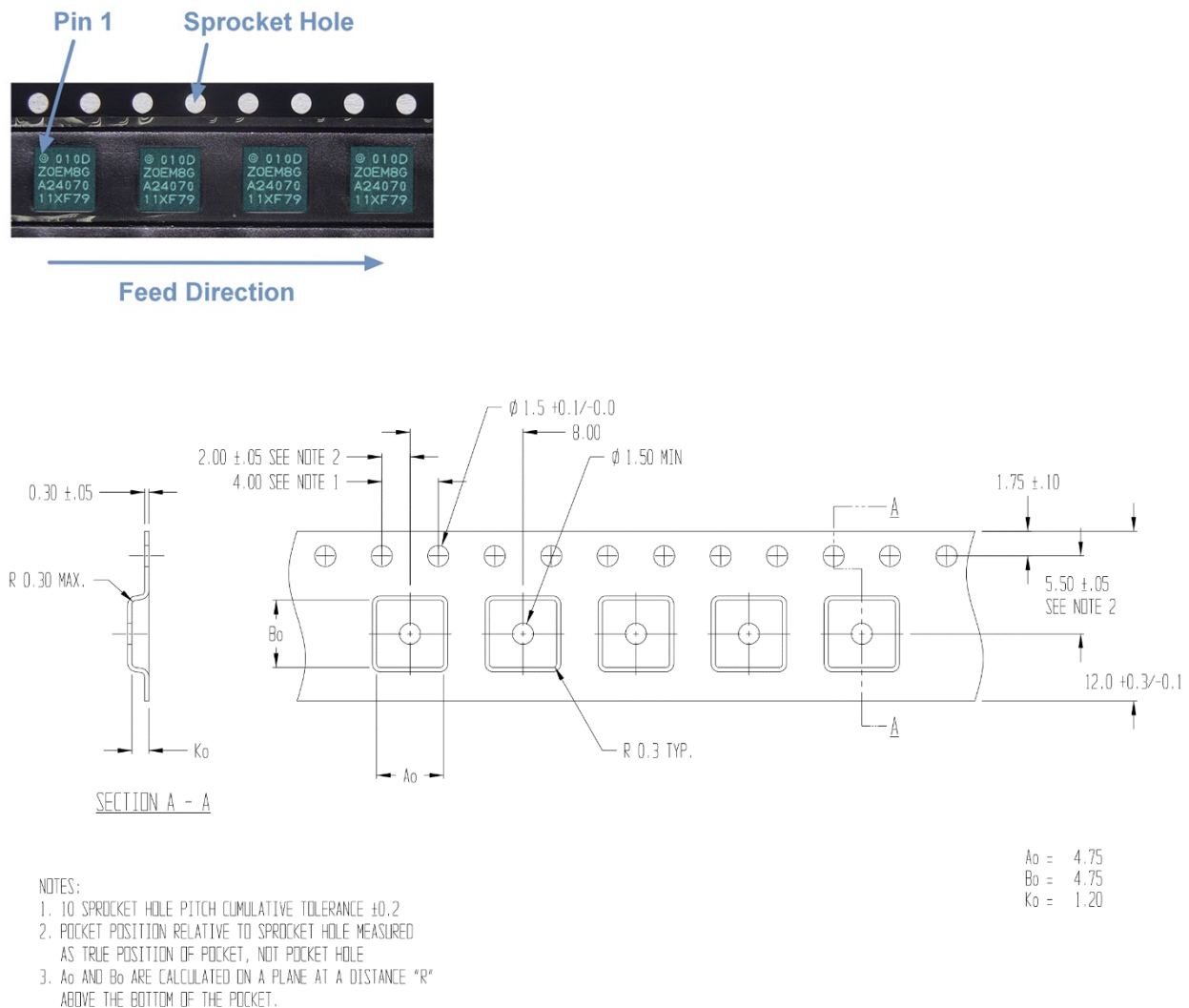



Figure 6: Dimensions and orientation for ZOE-M8 SiPs on the tape

6.2 Shipment, storage and handling

The absolute maximum rating of the storage temperature specified in the section 3.1 applies to the storage of the SiP both before and after soldering. Required storage conditions for SiPs in reeled tapes and for naked SiPs before soldering, other important information regarding shipment, storage and handling are described in the u-blox Package Information Guide [3].

6.3 Moisture sensitivity levels

The Moisture Sensitivity Level (MSL) relates to the packaging and handling precautions required. ZOE-M8 SiPs are rated at MSL level 3.

 For MSL standards, see IPC/JEDEC J-STD-020, which can be downloaded from www.jedec.org.

 For more information regarding MSL, see the u-blox Package Information Guide [3].

6.4 Reflow soldering

Reflow profiles are to be selected according u-blox recommendations (see the ZOE-M8 Hardware Integration Manual [1] for additional information).

6.5 ESD handling precautions

 ZOE-M8 positioning SiPs contain highly sensitive electronic circuitry and are Electrostatic Sensitive Devices (ESD). Observe precautions for handling! Failure to observe these precautions can result in severe damage to the GNSS receiver!

GNSS receivers are Electrostatic Sensitive Devices (ESD) and require special precautions when handling. Particular care must be exercised when handling patch antennas, due to the risk of electrostatic charges. In addition to standard ESD safety practices, the following measures should be taken into account whenever handling the receiver:

- Unless there is a galvanic coupling between the local GND (i.e. the work table) and the PCB GND, the first point of contact when handling the PCB must always be between the local GND and PCB GND.
- Before mounting an antenna patch, connect ground of the device
- When handling the RF pin, do not come into contact with any charged capacitors and be careful when contacting materials that can develop charges (e.g. patch antenna ~10 pF, coax cable ~50-80 pF/m, soldering iron, ...)
- To prevent electrostatic discharge through the RF input, do not touch any exposed antenna area. If there is any risk that such exposed antenna area is touched in non ESD protected work area, implement proper ESD protection measures in the design.
- When soldering RF connectors and patch antennas to the receiver's RF pin, make sure to use an ESD safe soldering iron (tip).

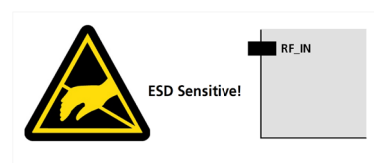

7 Default messages

Interface	Settings
UART Output	9600 Baud, 8 bits, no parity bit, 1 stop bit Configured to transmit both NMEA and UBX protocols, but only the following NMEA (no UBX) messages have been activated at start-up: GGA, GLL, GSA, GSV, RMC, VTG, TXT
UART Input	9600 Baud, 8 bits, no parity bit, 1 stop bit, Autobauding disabled Automatically accepts following protocols without need of explicit configuration: UBX, NMEA, RTCM The GNSS receiver supports interleaved UBX and NMEA messages.
DDC	Fully compatible with the I2C industry standard, available for communication with an external host CPU or u-blox cellular modules, operated in slave mode only. Default messages activated. NMEA and UBX are enabled as input messages, only NMEA as output messages. Maximum bit rate 400 kb/s.
SPI	Allow communication to a host CPU, operated in slave mode only. Default messages activated. SPI is not available in the default configuration.
TIMEPULSE (1 Hz Nav)	1 pulse per second, synchronized at rising edge, pulse length 100 ms

Table 16: Default messages

 Please refer to the u-blox 8 / u-blox M8 Receiver Description Including Protocol Specification [2] for information about further settings.

8 Labeling and ordering information

8.1 Product labeling

The labeling of u-blox M8 GNSS products includes important product information. The location of the ZOE-M8 product type number is shown in Figure 7.

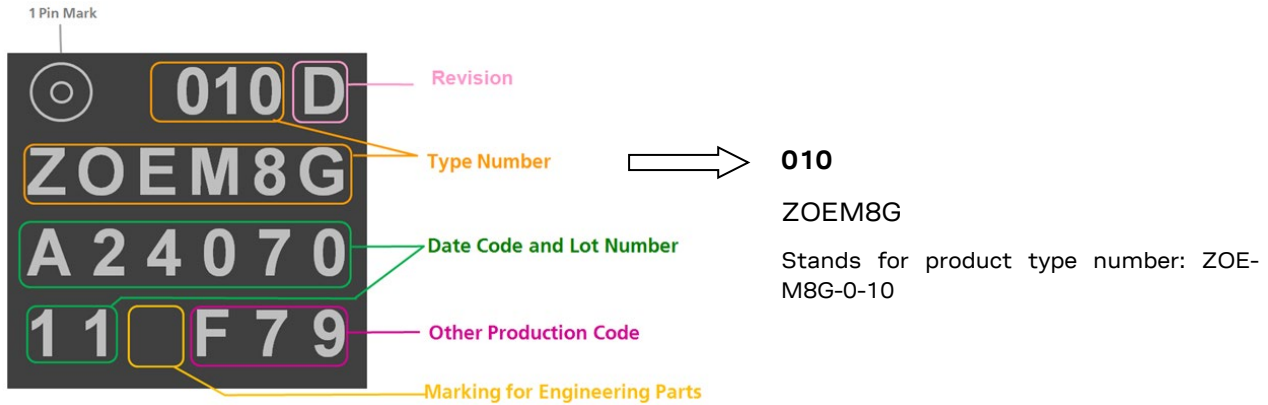

Figure 7: Description of ZOE-M8 product label (top view)

8.2 Explanation of product codes

Three different product code formats are used. The **Product Name** is used in documentation such as this data sheet and identifies all u-blox M8 products, independent of packaging and quality grade. The **Ordering Code** includes packaging and quality, while the **Type Number** includes the hardware and firmware versions. Table 17 below details these three different formats:

Format	Structure
Product Name	PPP-TGV
Ordering Code	PPP-TGV-N
Type Number	PPP-TGV-N-XX

Table 17: Product code formats

The parts of the product code are explained in Table 18.

Code	Meaning	Example
PPP	Product Family	ZOE
TG	Technology & Generation	M8 = u-blox M8
V	Variant	Function set (A-Z)
N	Option/ Quality Grade	Describes standardized functional element or quality grade; 0 = Default variant
XX	Product Detail	Describes product details or options such as hardware and software revision, cable length

Table 18: Part identification code

8.3 Ordering codes

Ordering No.	Product
ZOE-M8G-0	u-blox M8 concurrent GNSS S-LGA 1.8 V SiP, TCXO, ROM, 4.5x4.5 mm, 1000 pcs/reel
ZOE-M8Q-0	u-blox M8 concurrent GNSS S-LGA 3.0 V SiP, TCXO, ROM, 4.5x4.5 mm, 1000 pcs/reel

Table 19: Product ordering codes for professional grade positioning SiPs

8.4 Date code and lot number



The eight-digit **Date Code and Lot Number** includes the production date and lot number information.

Date Code and Lot Number	Meaning
YWWLLXXX	Y = production year, A = 2017, B = 2018, C = 2019 etc. WW = calendar week LL = lot number XXX = other production information

Table 20: Production date and lot number information

8.5 Pin 1 marking

The **pin 1 marking** is located on the top left corner.

-  The pin 1 marking shown in Figure 7 has changed. The change is effective from production date code and lot number **C0501XXX** (ZOE-M8G) and **B5101XXX** (ZOE-M8Q) onward.
-  Product changes affecting form, fit or function are documented by u-blox. For a list of Product Change Notifications (PCNs) see our website at: <http://www.u-blox.com/en/notifications.html>.

Related documents

- [1] ZOE-M8 Hardware Integration Manual, Doc. No. [UBX-16030136](#)
- [2] u-blox 8 / u-blox M8 Receiver Description Including Protocol Specification (public version), Doc. No. [UBX 13003221](#)
- [3] u-blox Package Information Guide, Doc. No. [UBX-14001652](#)
- [4] RTCM 10402.3 Recommended Standards for Differential GNSS, Ver. 2.3, RTCM AUG. 20, 2001
- [5] Radio Resource LCS Protocol (RRLP), (3GPP TS 44.031 version 11.0.0 Release 11)

 For regular updates to u-blox documentation and to receive product change notifications, register on our homepage (www.u-blox.com).

Revision history

Revision	Date	Name	Comments
R01	08-Dec-2016	jhak	Objective Specification
R02	16-Jan-2017	jhak	Updated section 1.5.4 (Galileo statement) and section 5 (qualification standard), updated Table 8 (VCC Max. rating), Figure 5 (mechanical specifications), Table 13 (average supply currents for GSP/QZSS/SBAS mode) and Figure 7 (product label description), added section 6.2 Shipment, storage and handling.
R03	21-Mar-2017	mdur	Advance Information. Updated mechanical drawing and dimensions (Figure 5), changed SW Backup current in Table 13 from 30 μ A to 20 μ A.
R04	11-Jul-2017	mdur	Added ZOE-M8Q variant. Updated power requirements (Table 13), product label information (Figure 7), and added tape dimensions and orientation information (Figure 6).
R05	13-Sep-2017	mdur	Updated mechanical drawing, product tape and label information (Figure 5, Figure 6 and Figure 7), remark modified for G9 pin in Table 7, parameter modified for V_{DIG} in Table 8.
R06	23-Oct-2017	mdur	Early Production Information. Modified highlights on page 1, Modified overview description (section 1.1), added a note about degraded position accuracy in power save mode (section 1.22.2.2),
R07	12-Dec-2017	mdur	Production Information. Corrected the statement about compatibility of AssistNow Autonomous in section 1.6.3.
R08	14-Aug-2019	mdur	Added RoHS Directive 2015/863/EU in section 5.2. Modified description of DCDC converter in section 1.22.1. Modified pin 1 marker in Figure 7: Description of ZOE-M8 product label (top view). Added Sections 8.4 (Date code and lot number) and 8.5 (Pin 1 marking).

Contact

For complete contact information, visit us at www.u-blox.com.

u-blox Offices

North, Central and South America

u-blox America, Inc.

Phone: +1 703 483 3180
E-mail: info_us@u-blox.com

Regional Office West Coast:

Phone: +1 408 573 3640
E-mail: info_us@u-blox.com

Technical Support:

Phone: +1 703 483 3185
E-mail: support@u-blox.com

Headquarters

Europe, Middle East, Africa

u-blox AG

Phone: +41 44 722 74 44
E-mail: info@u-blox.com
Support: support@u-blox.com

Asia, Australia, Pacific

u-blox Singapore Pte. Ltd.

Phone: +65 6734 3811
E-mail: info_ap@u-blox.com
Support: support_ap@u-blox.com

Regional Office Australia:

Phone: +61 2 8448 2016
E-mail: info_anz@u-blox.com
Support: support_ap@u-blox.com

Regional Office China (Beijing):

Phone: +86 10 68 133 545
E-mail: info_cn@u-blox.com
Support: support_cn@u-blox.com

Regional Office China (Chongqing):

Phone: +86 23 6815 1588
E-mail: info_cn@u-blox.com
Support: support_cn@u-blox.com

Regional Office China (Shanghai):

Phone: +86 21 6090 4832
E-mail: info_cn@u-blox.com
Support: support_cn@u-blox.com

Regional Office China (Shenzhen):

Phone: +86 755 8627 1083
E-mail: info_cn@u-blox.com
Support: support_cn@u-blox.com

Regional Office India:

Phone: +91 80 405 092 00
E-mail: info_in@u-blox.com
Support: support_in@u-blox.com

Regional Office Japan (Osaka):

Phone: +81 6 6941 3660
E-mail: info_jp@u-blox.com
Support: support_jp@u-blox.com

Regional Office Japan (Tokyo):

Phone: +81 3 5775 3850
E-mail: info_jp@u-blox.com
Support: support_jp@u-blox.com

Regional Office Korea:

Phone: +82 2 542 0861
E-mail: info_kr@u-blox.com
Support: support_kr@u-blox.com

Regional Office Taiwan:

Phone: +886 2 2657 1090
E-mail: info_tw@u-blox.com
Support: support_tw@u-blox.com

X-ON Electronics

Largest Supplier of Electrical and Electronic Components

Click to view similar products for [u-blox](#) category:

Click to view products by [U-Blox](#) manufacturer:

Other Similar products are found below :

[U-Blox](#)