

ZOE-M8B

Ultra-small, super low-power u-blox M8 GNSS SiP module

Data sheet

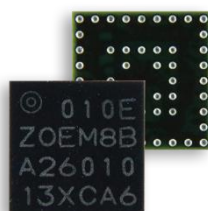

Abstract

Technical data sheet describing the ZOE-M8B ultra-small and super-low power GNSS SiP modules with Super-E mode. Power consumption is as low as 12 mW with Super-E mode. The modules provide a fully integrated, complete solution, reducing design and test efforts. Due to the built-in SAW and LNA, the modules are ideal for passive antennas, and, thanks to concurrent reception of up to 3 GNSS, they have high accuracy.

Document information

Title	ZOE-M8B	
Subtitle	Ultra-small, super low-power u-blox M8 GNSS SiP module	
Document type	Data sheet	
Document number	UBX-17035164	
Revision and date	R05	20-Mar-2020
Document status	Production Information	

Product status	Corresponding content status	
In Development / Prototype	Objective Specification	Target values. Revised and supplementary data will be published later.
Engineering Sample	Advance Information	Data based on early testing. Revised and supplementary data will be published later.
Initial Production	Early Production Information	Data from product verification. Revised and supplementary data may be published later.
Mass Production / End of Life	Production Information	Document contains the final product specification.

This document applies to the following products:

Product name	Type number	ROM/FLASH version	PCN reference
ZOE-M8B	ZOE-M8B-0-10	ROM SPG 3.51	N/A

u-blox or third parties may hold intellectual property rights in the products, names, logos and designs included in this document. Copying, reproduction, modification or disclosure to third parties of this document or any part thereof is only permitted with the express written permission of u-blox.

The information contained herein is provided "as is" and u-blox assumes no liability for its use. No warranty, either express or implied, is given, including but not limited to, with respect to the accuracy, correctness, reliability and fitness for a particular purpose of the information. This document may be revised by u-blox at any time without notice. For the most recent documents, visit www.u-blox.com.

Copyright © u-blox AG.

Contents

Document information	2
Contents	3
1 Functional description	5
1.1 Overview	5
1.2 Product features	5
1.3 GNSS performance	6
1.4 Block diagram	7
1.5 Supported GNSS constellations	7
1.5.1 GPS	8
1.5.2 GLONASS	8
1.5.3 BeiDou	8
1.5.4 Galileo	8
1.6 Assisted GNSS (A-GNSS).....	8
1.6.1 AssistNow™ Online.....	9
1.6.2 AssistNow™ Offline.....	9
1.6.3 AssistNow™ Autonomous	9
1.7 Augmentation systems	9
1.7.1 Satellite-based augmentation system (SBAS)	9
1.7.2 QZSS	10
1.7.3 IMES	10
1.7.4 Differential GPS (D-GPS).....	10
1.8 Broadcast navigation data and satellite signal measurements	10
1.9 Odometer	11
1.10 Data batching	11
1.11 Data logging	11
1.12 Geofencing.....	12
1.13 Message integrity protection	12
1.14 Spoofing detection	12
1.15 EXTINT: External interrupt.....	12
1.15.1 Pin control	12
1.15.2 Aiding	12
1.16 TIMEPULSE	12
1.17 Protocols and interfaces	13
1.18 Interfaces.....	13
1.18.1 UART	13
1.18.2 SPI	13
1.18.3 Display data channel (DDC)	13
1.18.4 Serial quad interface (SQI).....	13
1.18.5 Interface selection (D_SEL)	13
1.19 Configurable input output pins	14

1.20 Safe boot mode	14
1.21 System reset.....	14
1.22 Clock generation.....	14
1.22.1 Oscillator.....	14
1.22.2 Real-time clock (RTC)	14
1.23 Power management	15
1.23.1 Operating modes	15
1.24 Antenna.....	16
2 Pin definition	17
2.1 Pin assignment.....	17
3 Electrical specification	19
3.1 Absolute maximum rating.....	19
3.2 Operating conditions	20
3.2.1 DC electrical characteristic	20
3.2.2 Baseband parameters	21
3.3 Indicative power requirements.....	21
3.4 SPI timing diagrams	22
3.4.1 Timing recommendations.....	22
3.5 DDC timing diagrams	22
4 Mechanical specification	23
5 Reliability tests and approvals.....	24
5.1 Reliability tests	24
5.2 Approvals.....	24
6 Product handling.....	25
6.1 Packaging	25
6.1.1 Reels	25
6.1.2 Tapes.....	25
6.2 Shipment, storage and handling	26
6.3 Moisture sensitivity levels.....	26
6.4 Reflow soldering	26
6.5 ESD handling precautions.....	26
7 Default messages	27
8 Labeling and ordering information	28
8.1 Product labeling.....	28
8.2 Explanation of product codes.....	28
8.3 Ordering codes.....	28
8.4 Date code and lot number	29
8.5 Pin 1 marking	29
Related documents	30
Revision history	30
Contact.....	31

1 Functional description

1.1 Overview

ZOE-M8B is u-blox’s ultra-small, highly integrated GNSS SiP (System in Package) module, measuring just 4.5 x 4.5 x 1.0 mm.

Making use of the Super-Efficient (Super-E) mode, ZOE-M8B offers an ideal balance between miniature size, low power consumption and good GNSS performance. Super-E mode has two settings: “Performance” (the default) provides the best balance for power vs. performance; “power save” provides additional power savings at the cost of positioning accuracy. In Super-E mode, ZOE-M8B uses up to 2.5 times less power than a traditional M8 GNSS module with concurrent GNSS reception in 1 Hz full power mode, while still maintaining good positioning and speed accuracy. An average power consumption over a typical 30-minute track will be as low as 25 mW, using AssistNow Offline data and an industrial antenna design (that is, moderate-to-low signal levels).

The TCXO-based ZOE-M8B integrates a front-end SAW filter and an additional front-end LNA for increased jamming immunity and easier antenna integration. A passive antenna can be used to provide a highly integrated system solution with minimal eBOM.

Incorporating ZOE-M8B into customer designs is simple and straightforward thanks to the fully integrated design, single 1.8 V voltage supply, simple interface, and sophisticated interference suppression that ensure maximum performance even in GNSS-hostile environments. In addition, the ZOE-M8B provides an SQL interface for optional external flash, continuous data logging, and improved A-GNSS performance.

ZOE-M8B is based on the high performance of u-blox M8 concurrent GNSS engine, which supports GPS / GLONASS / BeiDou / Galileo, including message integrity protection, anti-jamming, and anti-spoofing. All of these features together provide reliable positioning in difficult environmental conditions, as well as in security attack scenarios.

ZOE-M8B is an ideal and fully integrated SiP solution for battery-powered wearable and portable devices, requiring low power and small size with good GNSS performance.

The ZOE-M8B can be easily integrated in manufacturing thanks to the advanced S-LGA (soldered land grid array) packaging technology, which enables easier and more reliable soldering processes compared to a normal LGA (land grid array) package.

The ZOE-M8B SiP is fully tested and qualified according to the JESD47 / ISO 16750 standard.

1.2 Product features

Model	Category	GNSS	Supply	Interfaces	Features	Grade
	Standard Precision GNSS High Precision GNSS Dead Reckoning Timing	GPS/QZSS GLONASS Galileo BeiDou Number of concurrent GNSS	1.71 V – 1.89 V 2.7 V – 3.6 V	UART USB SPI DDC (I ² C compliant)	Programmable (Flash) Data logging Additional SAW Additional LNA RTC crystal Oscillator Built-in antenna Timepulse	Standard Professional Automotive
ZOE-M8B	•	• • c •	•	• • •	E • • o T	•

E = External Flash required

c = only supported in continuous mode

o = Optional, or requires external components

T = TCXO

1.3 GNSS performance

Parameter	Specification					
Receiver type	72-channel u-blox M8 engine GPS L1C/A, QZSS L1C/A, QZSS L1-SAIF, GLONASS L1OF, BeiDou B1I, Galileo ¹ E1B/C, SBAS L1C/A: WAAS, EGNOS, MSAS, GAGAN					
Operational limits ²	Dynamics	≤ 4 g				
	Altitude	50,000 m				
	Velocity	500 m/s				
Velocity accuracy ³	Continuous mode	0.05 m/s				
	Super-E mode, performance setting (default) ⁶	0.2 m/s	Super-E mode, power save setting ⁶	0.4 m/s		
Heading accuracy ³	Continuous mode	0.3 degrees				
	Super-E mode, performance setting (default) ⁶	1 degree	Super-E mode, power save setting ⁶	2 degrees		
GNSS	GPS & GLONASS	GPS	GLONASS	BeiDou	Galileo	
Horizontal position accuracy in continuous mode ⁴	2.5 m	2.5 m	4.0 m	3.0 m	TBC ⁵	
Horizontal position accuracy in Super-E mode, performance setting (default) ^{4, 6}	3.5 m	3.0 m	9.0 m	N/A	not supported	
Horizontal position accuracy in Super-E mode, power save setting ^{4, 6}	4.0 m	3.5 m	10.5 m	N/A	not supported	
Max navigation update rate in continuous mode ⁷	10 Hz	18 Hz	18 Hz	18 Hz	18 Hz	
Max navigation update rate in Super-E mode	4 Hz	4 Hz	4 Hz	4 Hz	not supported	
Time-To-First-Fix ⁸	Cold start	26 s	29 s	30 s	34 s	45 s
	Hot start	1 s	1 s	1 s	1 s	1 s
	Aided starts ⁹	2 s	2 s	2 s	3 s	7 s
Sensitivity in continuous mode ¹⁰	Tracking & Navigation	-167 dBm	-166 dBm	-166 dBm	-160 dBm	-159 dBm
	Reacquisition	-160 dBm	-160 dBm	-156 dBm	-157 dBm	-153 dBm
	Cold start	-148 dBm	-148 dBm	-144 dBm	-143 dBm	-138 dBm
	Hot start	-157 dBm	-157 dBm	-154 dBm	-155 dBm	-151 dBm
Sensitivity in Super-E mode ¹⁰	Tracking & Navigation	-160 dBm	-160 dBm	-157 dBm	-159 dBm	not supported
	Reacquisition	-160 dBm	-160 dBm	-156 dBm	-157 dBm	not supported
	Cold start	-148 dBm	-148 dBm	-144 dBm	-143 dBm	not supported
	Hot start	-157 dBm	-157 dBm	-154 dBm	-155 dBm	not supported

Table 1: ZOE-M8B performance in different GNSS modes (default: concurrent reception of GPS and GLONASS)

¹ Galileo signals can be received reliably only in continuous mode. Galileo should not be enabled in Super-E mode.

² Assuming Airborne < 4 g platform

³ 50% at 30 m/s

⁴ CEP, 50%, 24 hours static, -130 dBm, > 6 SVs

⁵ To be confirmed when Galileo reaches full operational capability

⁶ Extreme operating temperatures can impact specification. Applications operating near the temperature limits should be tested to ensure the specifications.

⁷ Rates with SBAS and QZSS enabled for > 98% fix report rate under typical conditions

⁸ All satellites at -130 dBm, except Galileo at -127 dBm

⁹ Dependent on aiding data connection speed and latency

¹⁰ Demonstrated with a good external LNA

1.4 Block diagram

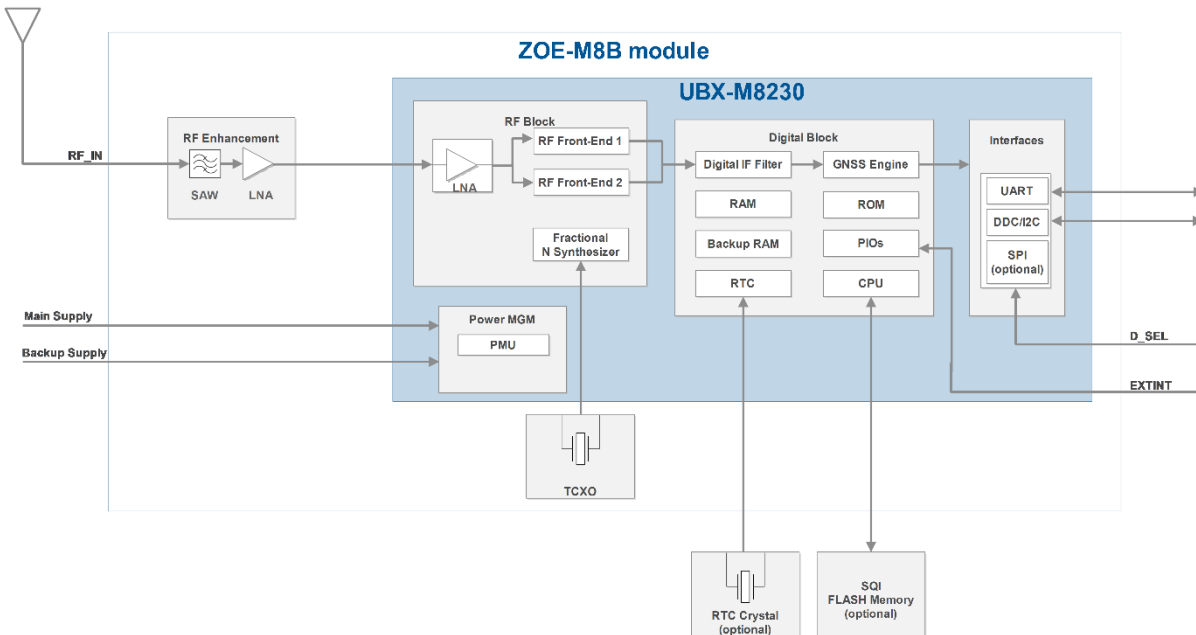

Figure 1: ZOE-M8B block diagram

1.5 Supported GNSS constellations

ZOE-M8B GNSS SiP is a concurrent GNSS receiver which can receive and track multiple GNSS systems: GPS, Galileo¹¹, GLONASS and BeiDou. Owing to the dual-frequency RF front-end architecture, either GLONASS or BeiDou can be processed concurrently with GPS and Galileo signals, providing reception of three GNSS systems. By default the M8 receivers are configured for concurrent GPS and GLONASS, including SBAS and QZSS reception. If power consumption is a key factor, then the receiver should be configured for a single-GNSS operation using GPS, GLONASS or BeiDou, and disabling SBAS.

u-blox M8 GNSS chips can be configured to receive any single-GNSS constellation or within the set of permissible combinations shown below.

GPS	BeiDou	GLONASS	Galileo10
•	–	–	•
•	–	•	•
•	•	–	•
•	–	•	–
•	•	–	–
–	–	•	•
–	•	–	•
–	•	•	–

Table 2: Permissible GNSS combinations (• = enabled)

QZSS can be enabled only if GPS operation is configured. QZSS should be enabled whenever GPS operation is configured.

¹¹ Galileo signals can be received reliably only in continuous mode. Galileo should not be enabled in Super-E mode.

 Galileo is not enabled in the default configuration. Galileo operation is supported only in continuous mode. Galileo should be disabled in Super-E mode.

1.5.1 GPS

The ZOE-M8B positioning SiP is designed to receive and track the L1C/A signals provided at 1575.42 MHz by the global positioning system (GPS).

1.5.2 GLONASS

The ZOE-M8B SiP can receive and process the GLONASS satellite system as an alternative to the US-based global positioning system (GPS). The u-blox ZOE-M8B positioning SiP is designed to receive and track the L1OF signals GLONASS provides at $1602 \text{ MHz} + k \cdot 562.5 \text{ kHz}$, where k is the satellite's frequency channel number ($k = -7, \dots, 5, 6$). The ability to receive and track GLONASS L1OF satellite signals allows design of GLONASS receivers where required by regulations.

To take advantage of GPS and GLONASS, dedicated hardware preparation must be made during the design-in phase. See the ZOE-M8B System Integration Manual [1] for u-blox design recommendations.

1.5.3 BeiDou

The ZOE-M8B SiP can receive and process the B1I signals broadcast at 1561.098 MHz from the BeiDou Navigation Satellite System. The ability to receive and track BeiDou signals in conjunction with another constellation results in higher coverage, improved reliability and better accuracy. Currently, BeiDou is not fully operational globally and provides Chinese regional coverage only. Global coverage is scheduled for 2020.

1.5.4 Galileo

ZOE-M8B receiver can receive and track the E1-B/C signals centered on the GPS L1 frequency band. GPS and Galileo signals can be processed concurrently together with either BeiDou or GLONASS signals, enhancing coverage, reliability and accuracy. The SAR return link message (RLM) parameters for both short and long versions are decoded by the receiver and made available to users via UBX proprietary messages.

 Galileo reception is by default disabled, but can be enabled by sending a configuration message (UBX-CFG-GNSS) to the receiver. See the u-blox 8 / u-blox M8 Receiver Description Including Protocol Specification [2] for more information.

 ZOE-M8B can acquire and track Galileo signals reliably only in continuous mode. Galileo should not be enabled in Super-E mode.

 Galileo has been implemented according to ICD release 1.3 (December 2016). At the time of implementation, the Galileo satellite system was not in full operational capability (FOC).

1.6 Assisted GNSS (A-GNSS)

Supply of GNSS receiver assistance information, such as ephemeris, almanac, rough user position and time, will reduce the time-to-first-fix significantly and improve acquisition sensitivity. All u-blox M8030-based products support the u-blox AssistNow Online and AssistNow Offline A-GNSS services, support AssistNow Autonomous, and are OMA SUPL compliant.

When using the AssistNow Online, Offline or Autonomous data, the ZOE-M8B GNSS receiver reaches minimal power consumption, since A-GNSS enables the receiver to maximize its power-optimized period. The A-GNSS assistance data also improves tracking accuracy in Super-E mode because the receiver can optimize the set of satellites used in low-power tracking.

1.6.1 AssistNow™ Online

With AssistNow Online, an internet-connected host downloads assistance data from the u-blox AssistNow Online service to the receiver at system start-up. The Multi-GNSS Assistance (MGA) service is an HTTP protocol-based network operator-independent service.

Supplying assistance information such as ephemeris, almanac, a rough last position and time, can reduce the time-to-first-fix significantly and improve acquisition sensitivity.

 The AssistNow Online service provides data for GPS, GLONASS, BeiDou, Galileo and QZSS

1.6.2 AssistNow™ Offline

With the AssistNow Offline service, users can download long-term orbit data over the Internet at their convenience. The orbit data can be stored in the memory of the application processor or alternatively external SQI flash memory (if available). The function requires no connectivity at system start-up, enabling a position fix within seconds, even when no network is available. AssistNow Offline offers augmentation for up to 35 days.

 AssistNow Offline service provides data for GPS and GLONASS only, BeiDou and Galileo are currently not supported.

1.6.3 AssistNow™ Autonomous

AssistNow Autonomous provides aiding information without the need for a host or external network connection. Based on previous broadcast satellite ephemeris data downloaded to and stored by the ZOE-M8B receiver, AssistNow Autonomous automatically generates accurate predictions of satellite orbital data (“AssistNow Autonomous data”) that is usable for future GNSS position fixes. The concept capitalizes on the periodic nature of GNSS satellites: their position in the sky is basically repeated every 24 hours. By capturing strategic ephemeris data at specific times of the day, the receiver can predict accurate satellite ephemeris for up to six days after initial reception. The use of an SQI flash memory is recommended when using AssistNow Autonomous, otherwise only GPS satellites are used and the prediction time decreases to three days.

u-blox’s AssistNow Autonomous benefits are:

- Faster fix in situations where GNSS satellite signals are weak
- No connectivity required
- Compatible with AssistNow Online (can work stand-alone, or in tandem with AssistNow Online service)
- No integration effort; calculations are done in the background, transparent to the user

 The ZOE-M8B SiP utilizing an external flash can predict accurate satellite ephemeris for up to six days after initial reception. The ROM-based ZOE-M8B SiP can use only GPS satellites with a prediction time of up to three days.

 For more information on A-GNSS see the u-blox 8 / u-blox M8 Receiver Description Including Protocol Specification [2].

1.7 Augmentation systems

1.7.1 Satellite-based augmentation system (SBAS)

ZOE-M8B GNSS receiver supports SBAS. These systems supplement GPS data with additional regional or wide-area GPS augmentation data. The system broadcasts augmentation data via satellite and this information can be used by GNSS receivers to improve the resulting precision. SBAS

satellites can be used as additional satellites for ranging (navigation), further enhancing precision and availability. The following SBAS types are supported: GAGAN, WAAS, EGNOS, and MSAS.

-  Tracking SBAS satellites uses power and requires a long decoding time. It is recommended to disable SBAS for Super-E mode. For more details, see u-blox 8 / u-blox M8 Receiver Description Including Protocol Specification [2].



1.7.2 QZSS

The Quasi-Zenith Satellite System (QZSS) is a regional navigation satellite system that transmits additional GPS L1C/A signals for the Pacific region covering Japan and Australia. The ZOE-M8B SiP is able to receive and track these signals concurrently with GPS signals, resulting in better availability especially under challenging signal conditions, for example, in urban canyons. The L1-SAIF signal provided by QZSS can be enabled for reception via a GNSS configuration message.

QZSS should be enabled whenever GPS operation is configured to prevent cross correlation issues.

1.7.3 IMES

The Japanese indoor messaging system (IMES) is used for indoor position reporting using low-power transmitters which broadcast a GPS-like signal. u-blox M8 receivers can be configured to receive and demodulate the signal to provide an in-door location estimate.



-  This service is authorized and available only in Japan.
-  IMES reception is disabled by default. IMES reception is supported only in continuous mode. It should be disabled in Super-E mode.

1.7.4 Differential GPS (D-GPS)

u-blox ZOE-M8B SiP supports differential-GPS (D-GPS) data according to RTCM specification 10402.3 [4] "Recommended Standards For Differential GNSS". The use of differential-GPS data improves GPS position accuracy. The RTCM implementation supports the following RTCM 2.3 messages:

Message type	Description
1	Differential GPS corrections
2	Delta differential GPS corrections
3	GPS reference station parameters
9	GPS partial correction set

Table 3: Supported RTCM 2.3 messages

-  RTCM corrections cannot be used together with SBAS.
-  For more details see the u-blox 8 / u-blox M8 Receiver Description Including Protocol Specification [2].
-  Reception and handling of the D-GPS data consumes additional power.

1.8 Broadcast navigation data and satellite signal measurements

The ZOE-M8B SiP can output all the GNSS broadcast data upon reception from tracked satellites. This includes all the supported GNSS signals plus the augmentation services SBAS, QZSS and IMES. The receiver also makes available the tracked satellite signal information, that is, raw code phase and

Doppler measurements in a form aligned to the Radio Resource LCS Protocol (RRLP) [5]. For more details see the u-blox 8 / u-blox M8 Receiver Description Including Protocol Specification [2].

1.9 Odometer

The odometer function provides information on traveled ground distance (in meters) based on the position and Doppler-based velocity output from the navigation solution. For each computed distance since the last odometer reset, the odometer estimates a 1-sigma accuracy value. The total cumulative ground distance is maintained and saved in the BBR memory.

 The odometer feature is enabled by default. For more details see the u-blox 8 / u-blox M8 Receiver Description Including Protocol Specification [2].

1.10 Data batching

The data batching feature allows position fixes to be stored in the RAM of the receiver to be retrieved later in one batch. Batching of position fixes happens independently of the host system, and can continue while the host is powered down.

Data batching is disabled by default. To utilize this feature, the batching operation must be enabled and the buffer size must be set. It is also possible to set up a PIO as a flag to indicate when the buffer is close to filling up.

The RAM available in the chip limits the size of the buffer. With the default 1 Hz navigation rate, up to five minutes of data can be stored to the buffer. To make the best use of the available space, only a minimum set of data is stored for each navigation epoch by default. More detailed information can be stored on the position fixes, however, this reduces the number of fixes that can be batched.

It is possible that the host is not able to retrieve the batched fixes before the buffer fills up. In such a case the oldest fix will be dropped and replaced with the newest. The host can request batching status information to see if fixes have been dropped.

For more information about configuration and use of the data batching see the u-blox 8 / u-blox M8 Receiver Description Including Protocol Specification [2] and ZOE-M8B System Integration Manual [1].

 Data batching is disabled per default. To utilize this feature, the batching operation must be enabled and the buffer size must be set. It is also possible to set up a PIO as a flag to indicate when the buffer is close to filling up.

1.11 Data logging

The ZOE-M8B SiP can be used in data logging applications. The data logging feature enables continuous storage of position, velocity and time information to an external SPI flash memory (at least 4 Mbit). It can also log the distance from the odometer and also additional data strings from the host. The information can be downloaded from the receiver later for further analysis or for conversion to a mapping tool.

Unlike the data batching, the data logging feature can store a large amount of data from a long period of time. However, the data logging requires use of external SPI flash.

 For more information see the u-blox 8 / u-blox M8 Receiver Description Including Protocol Specification [2].

1.12 Geofencing

The ZOE-M8B SiP supports up to four circular geofencing areas defined on the Earth's surface using a 2D model. Geofencing is active when at least one geofence is defined, the current status can be found by polling the receiver. A PIO pin can be nominated to indicate status to, for example, wake up a host on activation.

1.13 Message integrity protection

The ZOE-M8B SiP provides a function to detect third party interference with the UBX message stream sent from receiver to host. The security mechanism “signs” nominated messages via a subsequent UBX message. This message signature is then compared with the one generated by the host to determine if the message data has been altered. The signature algorithm seed can use one fixed secret ID key set by eFuse in production and a dynamic ID key set by the host, enabling users to detect “man-in-the-middle” style attacks.

1.14 Spoofing detection

Spoofing is a process whereby a malicious third party tries to control the reported position via a fake GNSS broadcast signal. This may result in the form of reporting incorrect position, velocity or time. To combat against this, the ZOE-M8B SiP includes spoofing detection measures to alert the host when signals appear to be suspicious. The receiver combines a number of checks on the received signals looking for inconsistencies across several parameters.



This feature does not guarantee to detect all spoofing attacks.

1.15 EXTINT: External interrupt

EXTINT is an external interrupt pin with fixed input voltage thresholds with respect to **VCC**. It can be used for control of the receiver or for aiding.

For more information about how to implement and configure these features, see the u-blox 8 / u-blox M8 Receiver Description including Protocol Specification [2] and the ZOE-M8B System Integration Manual [1].

1.15.1 Pin control

The pin control feature allows overriding the automatic active/inactive cycle of the Super-E mode, power save setting. The state of the receiver can be controlled through the **EXTINT** pin.

The receiver can also be forced OFF using **EXTINT** when the Super-E mode, power save setting is not active.

1.15.2 Aiding

The **EXTINT** pin can be used to supply time or frequency aiding data to the receiver.

For time aiding, the time can be supplied using hardware time synchronization where an accurate time pulse is connected to the **EXTINT** pin.

Frequency aiding can be implemented by connecting a periodic rectangular signal with a frequency up to 500 kHz and arbitrary duty cycle (low/high phase duration must not be shorter than 50 ns) to the **EXTINT** pin, and providing the applied frequency value to the receiver using UBX messages.

1.16 TIMEPULSE

Timepulse is not supported in ZOE-M8B.

1.17 Protocols and interfaces

Protocol	Type
NMEA	Input/output, ASCII, 0183, version 4.0 (Configurable to V2.1, V2.3 or V4.1)
UBX	Input/output, binary, u-blox proprietary
RTCM	Input, messages 1, 2, 3, 9

Table 4: Available protocols

All protocols are available on UART, DDC (I2C compliant) and SPI. For specification of the various protocols see the u-blox 8 / u-blox M8 Receiver Description Including Protocol Specification [2].

1.18 Interfaces

A number of interfaces are provided either for data communication or memory access. The embedded firmware uses these interfaces according to their respective protocol specifications.

1.18.1 UART

The ZOE-M8B SiP makes use of a UART interface, which can be used for communication to a host. It supports configurable baud rates. For supported transfer rates see the u-blox 8 / u-blox M8 Receiver Description Including Protocol Specification [2].

 Designs must allow access to the UART and the **SAFEBOOT_N** pin for future service, updates and reconfiguration.

1.18.2 SPI

The SPI interface is designed to allow communication to a host CPU. The interface can be operated in slave mode only. The maximum transfer rate using SPI is 125 kBytes/s and the maximum SPI clock frequency is 3 MHz, see section 3.4.1. Note that SPI is not available in the default configuration because its pins are shared with the UART and DDC interfaces. The SPI interface can be enabled by connecting PIO10 (D_SEL) to ground (see section 1.18.5). In this case the DDC interface for data communication is no longer available.

1.18.3 Display data channel (DDC)

An I2C-compliant DDC interface is available for communication with an external host CPU. The interface can be operated in slave mode only. The DDC protocol and electrical interface are fully compatible with Fast-Mode of the I2C industry standard. Since the maximum SCL clock frequency is 100 kHz, the maximum bit rate is 100 kbit/s.

1.18.4 Serial quad interface (SQI)

An SQI is available in ZOE-M8B SiP for connecting with an optional external flash memory. The flash memory is required for data logging. In addition, it can be used to store configurations and to save AssistNow Offline and AssistNow Autonomous data.

 For more information see the ZOE-M8B System Integration Manual [1].

1.18.5 Interface selection (D_SEL)

At startup the **D_SEL** pin determines which data interfaces are used for communication. If **D_SEL** is set to logical “1” or is not connected, UART and DDC become available. If **D_SEL** is set to logical “0”, i.e. connected to **GND**, the ZOE-M8B SiP can communicate to a host via SPI.

Pin #	(D_SEL)="1" (left open)	(D_SEL)="0" (connected to GND)
J5	UART TX	SPI MISO
J4	UART RX	SPI MOSI
B1	DDC SCL	SPI CLK
A2	DDC SDA	SPI CS_N

Table 5: Data interface selection by D_SEL

1.19 Configurable input output pins

Configuration settings can be modified for several input/output pins with either UBX configuration messages or pin selection. This flexible configuration options allow the receivers to be optimally configured for specific applications requirements. The modified settings remain either permanent or effective until power-down or reset depending on the case. Customers can activate or remap the following pins on ZOE-M8B SiP:

- Selection of DDC, UART TX/RX pins interface or SPI using **D_SEL** pin. See section 1.18.5.
- Selection of external interrupt pins. See section 1.15.



For more information see the ZOE-M8B System Integration Manual [1].

1.20 Safe boot mode

If pin C4 (**SAFEBOOT_N**) is set to logical “0” at startup, the ZOE-M8B receiver enters safe boot mode. In this mode the receiver does not calculate positioning data, but is in a defined state that allows such actions as programming the flash memory in production, or recovering a corrupted flash memory.



For more information about Safe Boot Mode see the ZOE-M8B System Integration Manual [1].

1.21 System reset

The ZOE-M8B SiP provides a **RESET_N** pin to reset the system and real-time clock (RTC). The **RESET_N** pin should be only used in critical situations to recover the system.

1.22 Clock generation

1.22.1 Oscillator

ZOE-M8B has a TCXO. The TCXO allows accelerated weak signal acquisition, enabling faster start and reacquisition times.



1.22.2 Real-time clock (RTC)

RTC may be optionally used to maintain time in the event of power failure at **VCC**. The RTC is required for hot start, warm start, AssistNow Autonomous, AssistNow Offline and some power save mode operations.

The use of the RTC is optional. The time information can be generated in one of these ways:

- By connecting to an external RTC crystal (for lower battery current – default mode)
- By sharing another RTC oscillator used within the application (for lowest system costs and smallest size)

If the main supply voltage fails and a battery is connected to **V_BCKP**, parts of the baseband section switch off, but the RTC still runs, providing a timing reference for the receiver. This operating mode is called hardware backup mode, which enables all relevant data to be saved in the backup RAM to later allow a hot or warm start.

-  See Table 12 for details of RTC voltage requirements when using an optional RTC.
-  For more information about crystal operation and configuration, see the ZOE-M8B System Integration Manual [1].
-  If neither backup RAM nor RTC are used, the backup battery is not needed and **V_BCKP** should be connected to **VCC**.

1.23 Power management

The ZOE-M8B SiP offers a power-optimized architecture with built-in autonomous power saving functions to minimize power consumption at any given time. Furthermore, the receiver can be used in different operating modes.

1.23.1 Operating modes

ZOE-M8B SiP can basically operate in two operating modes:

- Super-E Mode for best balance between power and performance
 - Continuous mode for best GNSS reception performance
 - For specific power-saving applications, the host system has also an option to set the receiver into its backup state. All essential data for quick re-starting of navigation can be saved either on the receiver side or on the host processor side.
 - For more information about power management strategies, see the ZOE-M8B System Integration Manual [1] and u-blox 8 / u-blox M8 Receiver Description Including Protocol Specification [2].
-  Unlike some other u-blox M8 receivers, the ZOE-M8B does not support self-managed ON/OFF power saving mode where the receiver periodically puts itself into the backup state.

1.23.1.1 Super-E mode

The ZOE-M8B GNSS SiP is intended to be run in the Super-E mode performance setting and defaults to this mode on power-up. The Super-E mode provides the best balance between current consumption vs. performance. Compared with the u-blox traditional u-blox 1 Hz full power mode, the Super-E provides 3x power savings while maintaining high levels of positioning and speed accuracy.

Super-E mode has two settings:

- The “performance” setting (the default) provides the best balance for power vs. performance.
- The “power save” setting provides additional power savings at the cost of positioning accuracy.

Super E-mode provides several navigation update rate options. The default navigation rate is 1 Hz, which gives low power consumption and good tracking accuracy. Selecting a 2 Hz or 4 Hz navigation rate improves the tracking accuracy, but also increases the power consumption. Using navigation rates with interval longer than 1 second (up to 10 seconds) achieve even lower power consumption.

The receiver will always start up in full power mode to search for satellites. In Super-E mode the receiver continues to search for more satellites after the first fix, until it has enough information for proper operation in the low power phase.

In the low power phase the receiver can also automatically duty-cycle an external LNA to further reduce the system total power usage.

Using AssistNow Online, Offline or Autonomous A-GNSS, assistance data helps the receiver to reach minimal power consumption, since A-GNSS enables the receiver to maximize its power-optimized period. The A-GNSS assistance data also improves tracking accuracy in Super-E mode because the receiver can optimize the set of satellites used in low-power tracking.

1.23.1.2 Continuous mode

Continuous mode uses the acquisition engine at full performance, resulting in the shortest possible TTFF and the highest sensitivity. It searches for all possible satellites until the almanac is completely downloaded. The receiver then switches to the tracking engine.

If balanced operation is selected for the continuous mode, then some GNSS RF operations are optimized. This reduces the power consumption slightly for the tracking phase.

In continuous mode, the navigation update rate can be raised up to 10 Hz in concurrent-GNSS mode and up to 18 Hz in single-GNSS mode.

1.24 Antenna

The ZOE-M8B SiP is designed for use with passive¹² and active¹³ antennas.

Parameter	Specification	
Antenna type	Passive and active antenna	
Active antenna recommendations	Minimum gain	10 dB (including cable loss)
	Maximum gain	30 dB
	Maximum noise figure	2 dB

Table 6: Antenna recommendations and specifications for ZOE-M8B SiP

¹² For integration ZOE-M8B SiP with Cellular products, see the ZOE-M8B System Integration Manual [1].

¹³ For information on using active antennas with ZOE-M8B SiP, see the ZOE-M8B System Integration Manual [1].

2 Pin definition

2.1 Pin assignment

This section shows the pin assignments. Most PIOs are configurable and have shared functions. Take special care when designing with these pins since the overall function of the device can be affected.

The default configuration of the PIOs is listed in Table 7 below.

For more information see the ZOE-M8B System Integration Manual [1].

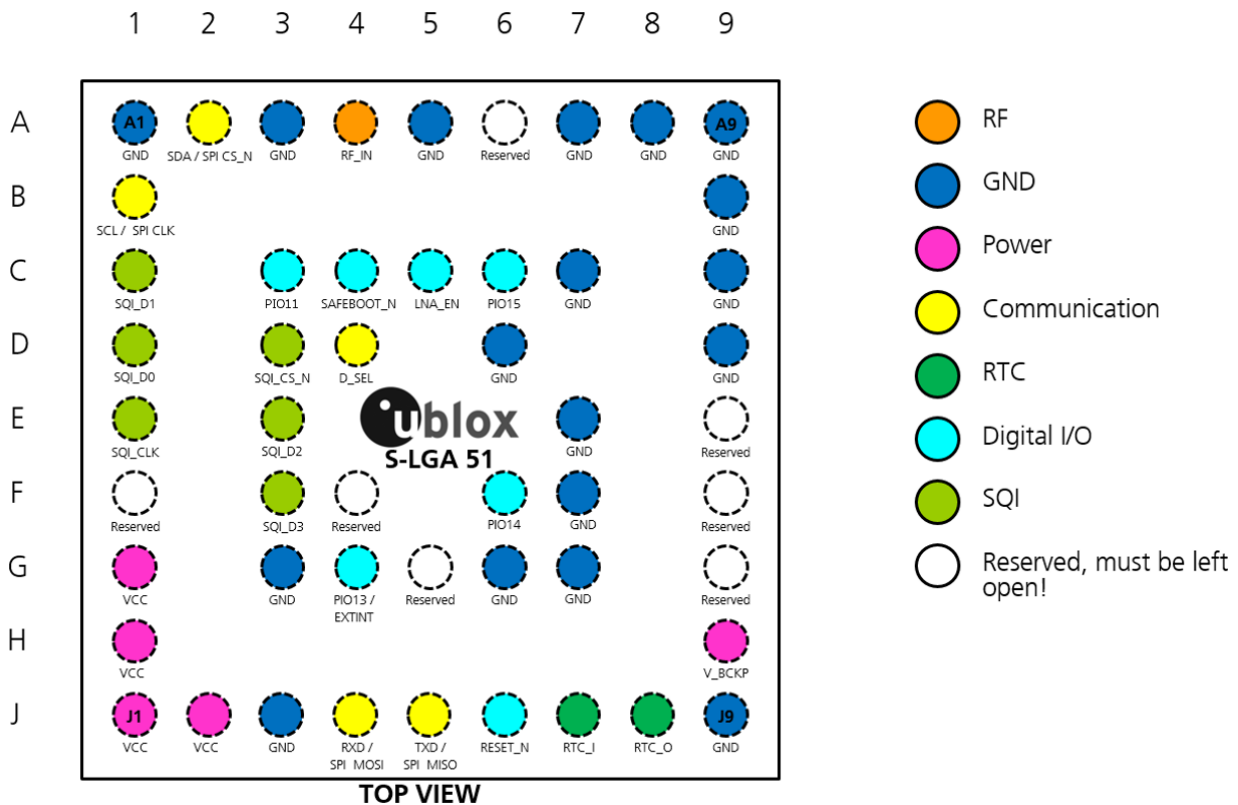

Figure 2: Pin assignment of ZOE-M8B (S-LGA51), top view

For multiple-function PIOs, select the specific signal by sending its configuration message.

Pin #	Name	I/O	Description	Remark
A1	GND		Ground	
A2	SDA / SPI CS_N	I/O	Serial interface. See section 1.18.5.	Leave open if not used.
A3	GND		Ground	
A4	RF_IN	I	GNSS signal input	
A5	GND		Ground	
A6	Reserved	I/O	Reserved	Do not connect. Must be left open!
A7	GND		Ground	
A8	GND		Ground	
A9	GND		Ground	
B1	SCL / SPI CLK	I	Serial interface. See section 1.18.5.	Leave open if not used.
B9	GND		Ground	
C1	SQI_D1	I	Data line 1 to external SQI flash memory or reserved configuration pin.	Leave open if not used.

Pin #	Name	I/O	Description	Remark
C3	PIO11	I/O	Digital I/O	Leave open if not used.
C4	SAFEBOOT_N	I	Used for programming the SQI flash memory and testing purposes.	Leave open if not used.
C5	LNA_EN	O	LNA on/off signal connected to internal LNA	Leave open if not used.
C6	PIO15	I/O	Digital I/O	Leave open if not used.
C7	GND		Ground	
C9	GND		Ground	
D1	SQI_D0	I/O	Data line 0 to external SQI flash memory or reserved configuration pin.	Leave open if not used.
D3	SQI_CS_N	I/O	Chip select for external SQI flash memory or configuration enable pin.	Leave open if not used.
D4	D_SEL	I	Interface selector. See section 1.18.5.	Leave open if not used.
D6	GND		Ground	
D9	GND		Ground	
E1	SQI_CLK	I/O	Clock for external SQI flash memory or configuration pin.	Leave open if not used.
E3	SQI_D2	I/O	Data line 2 to external SQI flash memory or reserved configuration pin.	Leave open if not used.
E7	GND		Ground	
E9	Reserved	I/O	Reserved	Do not connect. Must be left open!
F1	Reserved	I/O	Reserved	Do not connect. Must be left open!
F3	SQI_D3	I/O	Data line 3 to external SQI flash memory or reserved configuration pin.	Leave open if not used.
F4	Reserved	I/O	Reserved	Do not connect. Must be left open!
F6	PIO14	I/O	Digital I/O	Leave open if not used.
F7	GND		Ground	
F9	Reserved	I/O	Reserved	Do not connect. Must be left open!
G1	VCC	I	Supply voltage	Clean and stable supply needed
G3	GND		Ground	
G4	PIO13 / EXTINT	I	External interrupt	Leave open if not used.
G5	Reserved	I/O	Reserved	Do not connect. Must be left open!
G6	GND		Ground	
G7	GND		Ground	
G9	Reserved	I/O	Reserved	Do not connect. Must be left open! Only exception is V_BCKP, which can be connected to this pin if not used.
H1	VCC	I	Supply voltage	Clean and stable supply needed
H9	V_BCKP	I	Backup supply	
J1	VCC	I	Supply voltage	Clean and stable supply needed
J2	VCC	I	Supply voltage	Clean and stable supply needed
J3	GND		Ground	
J4	RXD/SPI MOSI	I	Serial interface. See section 1.18.5.	Leave open if not used.
J5	TXD/SPI MISO	O	Serial interface. See section 1.18.5.	Leave open if not used.
J6	RESET_N	I	System reset. See section 1.21.	Leave open if not used.
J7	RTC_I	I	RTC input	Connect to GND if no RTC crystal attached.
J8	RTC_O	O	RTC output	Leave open if no RTC crystal attached.
J9	GND		Ground	

Table 7: ZOE-M8B pinout

3 Electrical specification

The limiting values given are in accordance with the Absolute Maximum Rating System (IEC 134). Stress above one or more of the limiting values may cause permanent damage to the device. These are stress ratings only, and operation of the device at these or at any other conditions above those given in the Characteristics sections of the specification is not implied. Exposure to limiting values for extended periods may affect device reliability.

Where application information is given, it is advisory only and does not form part of the specification. For more information regarding power management see the ZOE-M8B System Integration Manual [1].

3.1 Absolute maximum rating

Symbol	Parameter	Min	Max	Unit
VCC	Supply voltage	-0.5	3.6	V
V_BCKP	Supply voltage baseband backup core	-0.5	3.6	V
V _{RTC}	Input voltage on RTC_I	-0.5	1.6	V
V _{DIG}	Input voltage on configurable Inputs , RESET_N if VCC < 3.1 V	-0.5	VCC+0.5	V
	Input voltage on configurable Inputs , RESET_N if VCC > 3.1 V	-0.5	3.6	V
Pr _{fin}	RF Input power on RF_IN inband ¹⁴		0	dBm
	RF Input power on RF_IN outband ¹⁵		+15	dBm
P _{tot}	Total power dissipation		500	mW
T _s	Storage temperature	-40	+85	°C

Table 8: Absolute maximum ratings

Stressing the device beyond the “Absolute Maximum Ratings” may cause permanent damage. These are stress ratings only. The product is not protected against overvoltage or reversed voltages. If necessary, voltage spikes exceeding the power supply voltage specification, given in Table 8, must be limited to values within the specified boundaries by using appropriate protection diodes.

¹⁴ Inband = 1525-1650 MHz

¹⁵ Outband = 777-915 MHz, 1710-2200 MHz

3.2 Operating conditions

The test conditions specified in Table 9 apply to all characteristics defined in this section.

Symbol	Parameter	Min	Typical	Max	Unit	Remarks
Tamb	Ambient temperature	-40	+25	+85	°C	
GND	Ground		0		V	
VCC	Supply voltage		1.8		V	
V_BCKP	Backup battery supply voltage		1.8		V	
NFtot	Receiver chain noise figure		2.5		dB	

Table 9: Test conditions

All specifications are at an ambient temperature of 25 °C. Extreme operating temperatures can significantly impact specification values. Applications operating near the temperature limits should be tested to ensure the specification.

3.2.1 DC electrical characteristic

For power management unit (PMU) block diagrams, see the ZOE-M8B System Integration Manual [1].

Symbol	Parameter	Min	Typical	Max	Unit
V_BCKP	Input voltage for backup supply	1.4		3.6	V
VCC ¹⁶	Supply voltage	1.71		1.89	V

Table 10: Power supply pins

Symbol	Parameter	Condition	Min	Typical	Max	Unit
Ileak	Leakage current input pins			< 1		nA
Vil	Low level input voltage		0		0.2*VCC	V
Vih	High level input voltage		0.7*VCC		VCC+0.5	V
Vol	Low level output voltage for TXD/SPI MISO, RXD/SPI MOSI, SDA/SPI CS_N, SCL/SPI CLK, D_SEL, PIO11, PIO13/EXTINT, PIO14, PIO15, LNA_EN	Iol = 4 mA			0.4	V
Voh	High level output voltage for TXD/SPI MISO, RXD/SPI MOSI, SDA/SPI CS_N, SCL/SPI CLK, D_SEL, PIO11, PIO13/EXTINT, PIO14, PIO15, LNA_EN	Ioh = 4 mA	VCC-0.4			V
Rpu	Pull-up resistor for SDA/SPI CS_N, SCL/SPI CLK, PIO11, PIO13/EXTINT, PIO14, RESET_N			11		kΩ
Rpu	Pull-up resistor for TXD/SPI MISO, RXD/SPI MOSI, PIO15, D_SEL			115		kΩ

Table 11: Digital IO pins

¹⁶ Max 50 mVpp ripple

3.2.2 Baseband parameters

Symbol	Parameter	SiP	Condition	Min	Typ.	Max	Unit
RTC_Fxtal	RTC crystal resonant frequency	All			32768		Hz
RTC_T_start	RTC startup time	All		0.2	0.35	0.9	sec
RTC_Amp	32768 Hz OSC oscillation amplitude	All		50		350	mVpp
RTC_ESR	32768 Hz Xtal equivalent series resistance	All				100	kΩ
RTC_CL	RTC integrated load capacitance	All	ESR = 80 kΩ	4	7	12	pF

Table 12: Baseband parameters

3.3 Indicative power requirements

Table 13 lists examples of the total system supply current for a possible application.

The values in Table 13 are provided for customer information only as an example of typical current requirements. The values are characterized on samples; actual power requirements can vary depending on the firmware version used, external circuitry, number of SVs tracked, signal strength, type of start as well as time, duration and conditions of test.

Parameter	Symbol	Typical GPS & GLONASS	Typical GPS	Max	Units	Condition
Max supply current ¹⁷	lccp			70	mA	VCC = 1.8 V
Average supply current ¹⁸	lcc aquisition ¹⁹	45	34.5		mA	VCC = 1.8 V
	lcc tracking (continuous mode)	40	32.5		mA	VCC = 1.8 V
	lcc tracking (Super-E mode, performance setting (default) / 1 Hz)	8.3	7.3		mA	VCC = 1.8 V
	lcc tracking (Super-E mode, power save setting / 1 Hz)	6.8	6.3		mA	VCC = 1.8 V
Backup battery current ²⁰	I_BCKP	15			uA	HW backup mode, VCC = 0 V, V_BCKP = 3 V using the RTC crystal
SW backup current	I_SWBCKP	20			uA	SW backup mode, VCC = 1.8 V, using the RTC crystal

Table 13: Currents to calculate the indicative power requirements

For more information about power requirements, see the ZOE-M8B System Integration Manual [1].

All values in Table 13 are measured at 25 °C ambient temperature.

¹⁷ Use this figure to dimension the maximum current capability of power supply. Measurement of this parameter with 1 Hz bandwidth.

¹⁸ Simulated constellation of 8 satellites is used. All signals are at -130 dBm.

¹⁹ Average current from startup until the first fix.

²⁰ Use this figure to determine required battery capacity.

3.4 SPI timing diagrams

To avoid incorrect operation of the SPI, you need to comply with certain timing conditions. The following signals need to be considered for timing constraints:

Symbol	Description
SPI CS_N (SS_N)	Slave select signal
SPI CLK (SCK)	Slave clock signal

Table 14: Symbol description

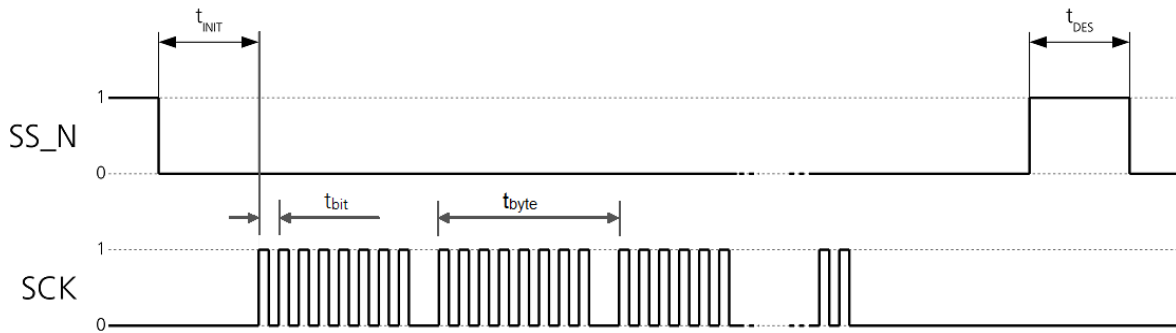

Figure 3: SPI timing diagram

3.4.1 Timing recommendations

The recommendations below are based on a firmware running from SQI flash memory.

Parameter	Description	Recommendation
t_{INIT}	Minimum initialization Time	10 μ s
t_{DES}	Deselect time	1 ms.
t_{bit}	Minimum bit time	1 μ s (1 MHz max bit frequency)
t_{byte}	Minimum byte period	8 μ s (125 kHz max byte frequency)

Table 15: SPI timing recommendations

- The values in the above table result from the requirement of an error-free transmission. By allowing just a few errors and disabling the glitch filter, the bit rate can be increased considerably.

3.5 DDC timing diagrams

The DDC interface is I2C Fast Mode compliant. For timing parameters consult the I2C standard.

- The maximum bit rate is 100 kbit/s. The interface stretches the clock when slowed down while serving interrupts, so real bit rates may be slightly lower.

4 Mechanical specification

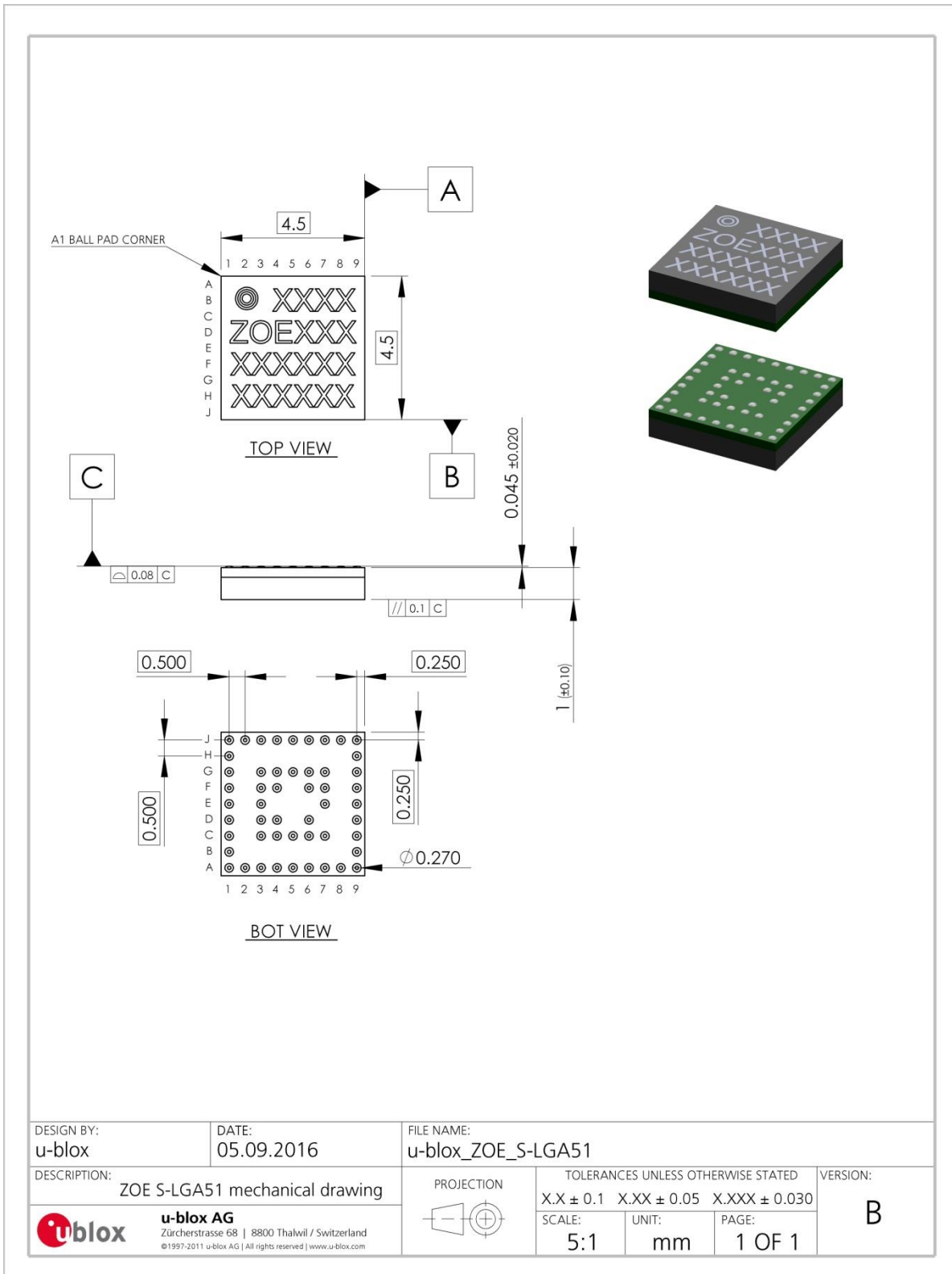

Figure 4: Mechanical drawing for ZOE-M8B (S-LGA), bottom view

5 Reliability tests and approvals

5.1 Reliability tests

 ZOE-M8B SiP is based on AEC-Q100 qualified GNSS chips.

Qualification requirements according JEDEC standards JESD47 "Stress-Test-Driven Qualification of Integrated Circuits" and ISO 16750 "Road vehicles – environmental conditions and testing for electrical and electronic equipment".

5.2 Approvals



The ZOE-M8B SiP complies with the Directives 2011/65/EU and 2015/863/EU of the European Parliament and the Council on the Restriction of Use of certain Hazardous Substances (RoHS).

6 Product handling

6.1 Packaging

To enable efficient production, production lot set-up and tear-down, ZOE-M8B is delivered in hermetically sealed, reeled tapes. For more information about packaging, see the u-blox Package Information Guide [3].

6.1.1 Reels

ZOE-M8B is deliverable in quantities of 1000 pcs on a reel. The ZOE-M8B SiP is shipped on Reel Type D, as described in the u-blox Package Information Guide [3].

6.1.2 Tapes

Figure 5 shows the feed direction and the orientation of the ZOE-M8B positioning SiP on the tape. The positioning SiPs are placed so that the pin 1 is at the upper right for the S-LGA51 (soldered LGA). The dimensions of the tapes are specified in the lower part of Figure 5.

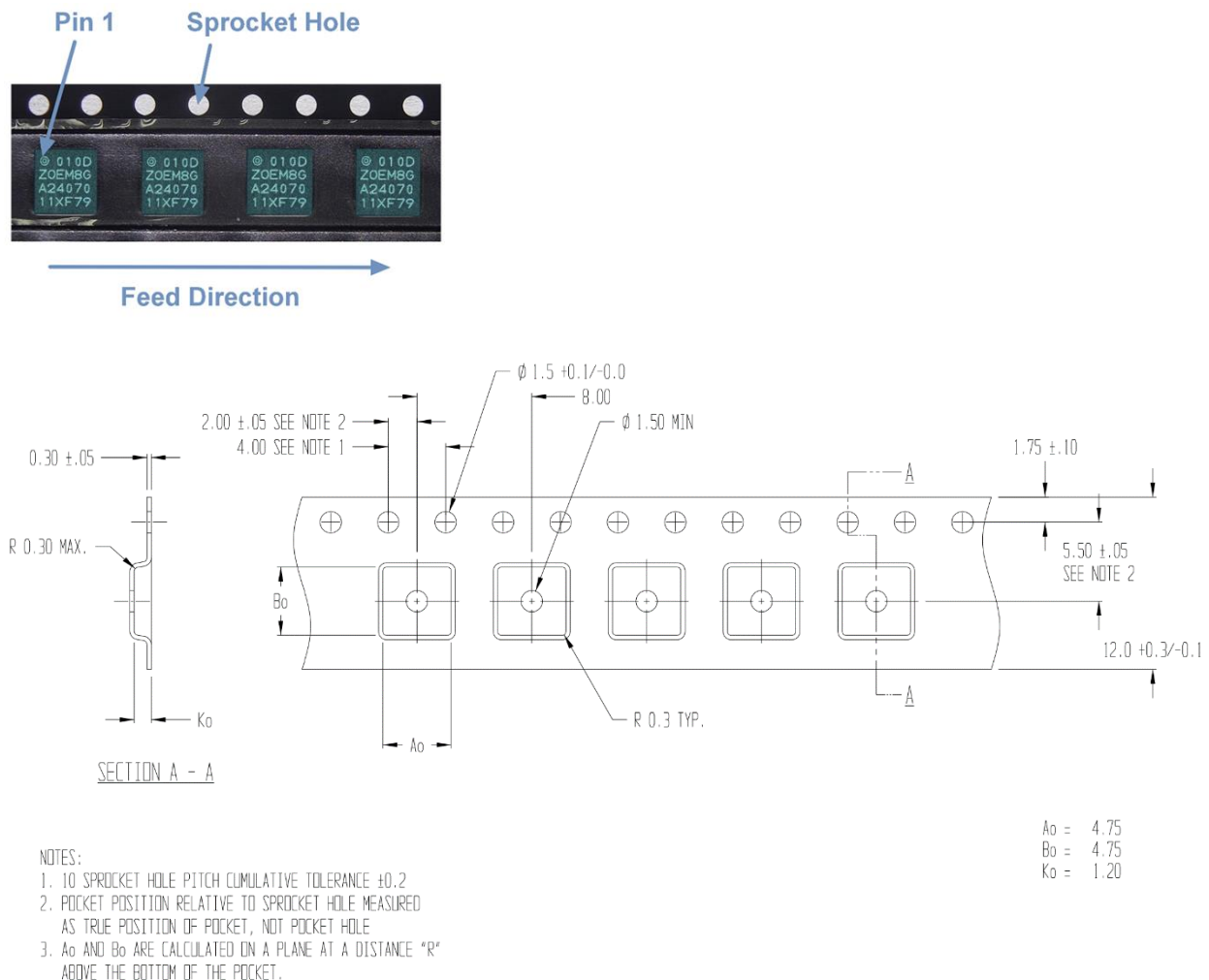



Figure 5: Dimensions and orientation for ZOE-M8B SiPs on the tape

6.2 Shipment, storage and handling

The absolute maximum rating of the storage temperature specified in section 3.1 applies to the storage of the SiP both before and after soldering. Required storage conditions for SiPs in reeled tapes and for naked SiPs before soldering, other important information regarding shipment, storage and handling are described in the u-blox Package Information Guide [3].

6.3 Moisture sensitivity levels

The moisture sensitivity level (MSL) relates to the packaging and handling precautions required. ZOE-M8B SiP is rated at MSL level 3.

 For MSL standard see IPC/JEDEC J-STD-020, which can be downloaded from www.jedec.org.

 For more information regarding MSL see the u-blox Package Information Guide [3].

6.4 Reflow soldering

Reflow profiles are to be selected according u-blox recommendations (see the ZOE-M8B System Integration Manual [1]).

6.5 ESD handling precautions

 ZOE-M8B positioning SiPs contain highly sensitive electronic circuitry and are Electrostatic Sensitive Devices (ESD). Observe precautions for handling! Failure to observe these precautions can result in severe damage to the GNSS receiver!

GNSS receivers are Electrostatic Sensitive Devices (ESD) and require special precautions when handling. Exercise particular care when handling patch antennas, due to the risk of electrostatic charges. In addition to standard ESD safety practices, take the following measures into account whenever handling the receiver:

- Unless there is a galvanic coupling between the local GND (i.e. the work table) and the PCB GND, the first point of contact when handling the PCB must always be between the local GND and PCB GND.
- Before mounting an antenna patch, connect ground of the device.
- When handling the RF pin, do not come into contact with any charged capacitors and be careful when contacting materials that can develop charges (e.g. patch antenna ~10pF, coax cable ~50-80 pF/m, soldering iron).
- To prevent electrostatic discharge through the RF input, do not touch any exposed antenna area. If there is any risk that such exposed antenna area is touched in a non-ESD protected work area, implement proper ESD protection measures in the design.
- When soldering RF connectors and patch antennas to the receiver's RF pin, make sure to use an ESD safe soldering iron (tip).

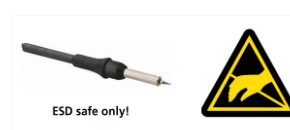

7 Default messages

Interface	Settings
UART Output	9600 baud, 8 bits, no parity bit, 1 stop bit Configured to transmit both NMEA and UBX protocols, but only the following NMEA (no UBX) messages have been activated at start-up: GGA, GLL, GSA, GSV, RMC, VTG, TXT
UART Input	9600 baud, 8 bits, no parity bit, 1 stop bit, autobauding disabled Automatically accepts the following protocols without need of explicit configuration: UBX, NMEA, RTCM The GNSS receiver supports interleaved UBX and NMEA messages.
DDC	Fully compatible with the I2C industry standard, available for communication with an external host CPU or u-blox cellular modules, operated in slave mode only. Default messages activated. NMEA and UBX are enabled as input messages, only NMEA as output messages. Maximum bit rate 100 kb/s.
SPI	Allow communication to a host CPU, operated in slave mode only. Default messages activated. SPI is not available in the default configuration.

Table 16: Default messages

 Please refer to the u-blox 8 / u-blox M8 Receiver Description Including Protocol Specification [2] for information about further settings.

8 Labeling and ordering information

8.1 Product labeling

The labeling of u-blox M8 GNSS SiP includes important product information. The location of the ZOE-M8B product type number is shown in Figure 6.

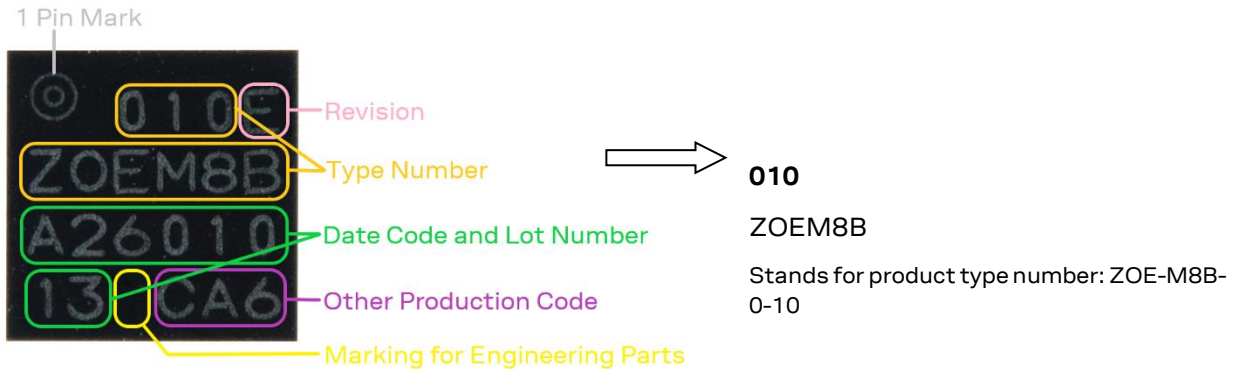

Figure 6: Description of ZOE-M8B product label

8.2 Explanation of product codes

Three different product code formats are used. The **Product Name** is used in documentation such as this data sheet and identifies all u-blox M8 products, independent of packaging and quality grade. The **Ordering Code** includes packaging and quality, while the **Type Number** includes the hardware and firmware versions. Table 17 below details these three different formats:

Format	Structure
Product name	PPP-TGV
Ordering code	PPP-TGV-N
Type number	PPP-TGV-N-XX

Table 17: Product code formats

The parts of the product code are explained in Table 18.

Code	Meaning	Example
PPP	Product family	ZOE
TG	Technology and generation	M8 = u-blox M8
V	Variant	Function set (A-Z)
N	Option/ quality grade	Describes standardized functional element or quality grade; 0 = Default variant
XX	Product detail	Describes product details or options such as hardware and software revision, cable length

Table 18: Part identification code

8.3 Ordering codes

Ordering code	Product
ZOE-M8B-0	u-blox M8 low-power concurrent GNSS S-LGA 1.8 V SiP, TCXO, ROM, 4.5x4.5 mm, 1000 pcs/reel

Table 19: Product ordering codes for professional grade positioning SiP

8.4 Date code and lot number



The eight-digit **Date Code and Lot number** includes the production date and lot number information.

Date code and Lot number	Meaning
YWWLLXXX	Y = production year, A = 2017, B = 2018, C = 2019 etc. WW = calendar week LL = lot number XXX = other production information

Table 20: Production date and lot number information

8.5 Pin 1 marking

The **pin 1 marking** is located on the top left corner.

-  The pin 1 marking shown in Figure 6 has changed. The change is effective from production date code and lot number **C0201XXX** onward.
-  Product changes affecting form, fit or function are documented by u-blox. For a list of Product Change Notifications (PCNs) see our website at: <http://www.u-blox.com/en/notifications.html>.

Related documents

- [1] ZOE-M8B System integration manual, doc. no. UBX-17045131
- [2] u-blox 8 / u-blox M8 Receiver Description Including Protocol Specification (Public version), doc. no. UBX 13003221
- [3] u-blox Package Information Guide, doc. no. UBX-14001652
- [4] RTCM 10402.3 Recommended Standards for Differential GNSS, Ver. 2.3, RTCM AUG. 20, 2001
- [5] Radio Resource LCS Protocol (RRLP), (3GPP TS 44.031 version 11.0.0 Release 11)

 For regular updates to u-blox documentation and to receive product change notifications, register on our homepage (www.u-blox.com).

Revision history

Revision	Date	Name	Comments
R01	21-Sep-2017	mdur	Objective Specification
R02	5-Feb-2018	mdur	Early Production Information, Super-E mode settings added in section 1.23.1.1, updated the GNSS performance figures in Table 1, updated the indicative power requirements in Table 13, changed minimum SQI flash size for logging in section 1.11.
R03	14-Mar-2018	mdur	Production Information
R04	13-Aug-2019	rmak	Updated Figure 1 (block diagram), Figure 6 (ZOE-M8B product label with pin 1 marker) and Section 5.2 (RoHS statement). Added Sections 8.4 (Date code and lot number) and 8.5 (Pin 1 marking).
R05	20-Mar-2020	rmak	Updated section 1.5.4 Galileo (removed reference to a possible flash firmware upgrade).

Contact

For complete contact information, visit us at www.u-blox.com.

u-blox Offices

North, Central and South America

u-blox America, Inc.

Phone: +1 703 483 3180
E-mail: info_us@u-blox.com

Regional Office West Coast:

Phone: +1 408 573 3640
E-mail: info_us@u-blox.com

Technical Support:

Phone: +1 703 483 3185
E-mail: support@u-blox.com

Headquarters

Europe, Middle East, Africa

u-blox AG

Phone: +41 44 722 74 44
E-mail: info@u-blox.com
Support: support@u-blox.com

Asia, Australia, Pacific

u-blox Singapore Pte. Ltd.

Phone: +65 6734 3811
E-mail: info_ap@u-blox.com
Support: support_ap@u-blox.com

Regional Office Australia:

Phone: +61 2 8448 2016
E-mail: info_anz@u-blox.com
Support: support_ap@u-blox.com

Regional Office China (Beijing):

Phone: +86 10 68 133 545
E-mail: info_cn@u-blox.com
Support: support_cn@u-blox.com

Regional Office China (Chongqing):

Phone: +86 23 6815 1588
E-mail: info_cn@u-blox.com
Support: support_cn@u-blox.com

Regional Office China (Shanghai):

Phone: +86 21 6090 4832
E-mail: info_cn@u-blox.com
Support: support_cn@u-blox.com

Regional Office China (Shenzhen):

Phone: +86 755 8627 1083
E-mail: info_cn@u-blox.com
Support: support_cn@u-blox.com

Regional Office India:

Phone: +91 80 405 092 00
E-mail: info_in@u-blox.com
Support: support_in@u-blox.com

Regional Office Japan (Osaka):

Phone: +81 6 6941 3660
E-mail: info_jp@u-blox.com
Support: support_jp@u-blox.com

Regional Office Japan (Tokyo):

Phone: +81 3 5775 3850
E-mail: info_jp@u-blox.com
Support: support_jp@u-blox.com

Regional Office Korea:

Phone: +82 2 542 0861
E-mail: info_kr@u-blox.com
Support: support_kr@u-blox.com

Regional Office Taiwan:

Phone: +886 2 2657 1090
E-mail: info_tw@u-blox.com
Support: support_tw@u-blox.com

X-ON Electronics

Largest Supplier of Electrical and Electronic Components

Click to view similar products for [GPS Modules](#) category:

Click to view products by [U-Blox](#) manufacturer:

Other Similar products are found below :

[A5135-H](#) [EWM-G109H01E](#) [ISM3333-C6.1](#) [S2-106ZN](#) [ZOE-M8Q-0](#) [EL.1A](#) [MIKROE-4150](#) [A2235H](#) [POL-2G](#) [L70B-M39](#) [2613011037000](#)
[101990655](#) [2614011037000](#) [L26T-S89](#) [L26ADR-S89](#) [L89-S90](#) [GPS-11858](#) [4037735104327](#) [RXM-GNSS-TM-T](#) [EWM-G108H01E](#) [DD-](#)
[14239](#) [GPS-10922](#) [GPS-12751](#) [NEO-M8M-0](#) [NEO-M8P-0](#) [SIM28ML](#) [RXM-GNSS-GM-T](#) [SIM28](#) [M10578-A3](#) [M10578-A3-U2](#) [FT-X-GPS](#)
[GPS-13740](#) [PKG300060P](#) [PKG300071](#) [PKG300071P](#) [PKG900000000271T](#) [PKG900000000853P](#) [PKG900000000853T](#) [RXM-GNSS-TM-B](#)
[RXM-GPS-F4-T](#) [RXM-GPS-FM-B](#) [RXM-GPS-FM-T](#) [RXM-GPS-R4-T](#) [A1084-A](#) [A2100-A](#) [A2200-A](#) [A2235-H](#) [A5100-A](#) [28504](#)
[113990659](#)