

APPROVAL SHEET

To :

Customer P/N :

UDE P/N : RM3-138A9V1F

Description : RJ45 multiport 2X1

Through Hole

10/100/1000 Base-T

Contact Area : 30 μ " Gold

LED:L-Green; R-Green/Yellow



Spec No.
RM3138-00

Update Date
2015/12/25

Revision
C

Approved	Checked	Prepared



湧德電子 股份有限公司
UDE Corp.

8F-1, No.58, Tongde 11th St., Taoyuan City, Taoyuan County (330), Taiwan
桃園縣桃園市(330)同德十一街58號 8F之1

TEL:+886-3-3568600 FAX:+886-3-3560611

<http://www.ude-corp.com/>

1. MECHANICAL DIMENSION

1.1 Product Dimension

General Tolerance : X.X : ± 0.38
X.XX : ± 0.25

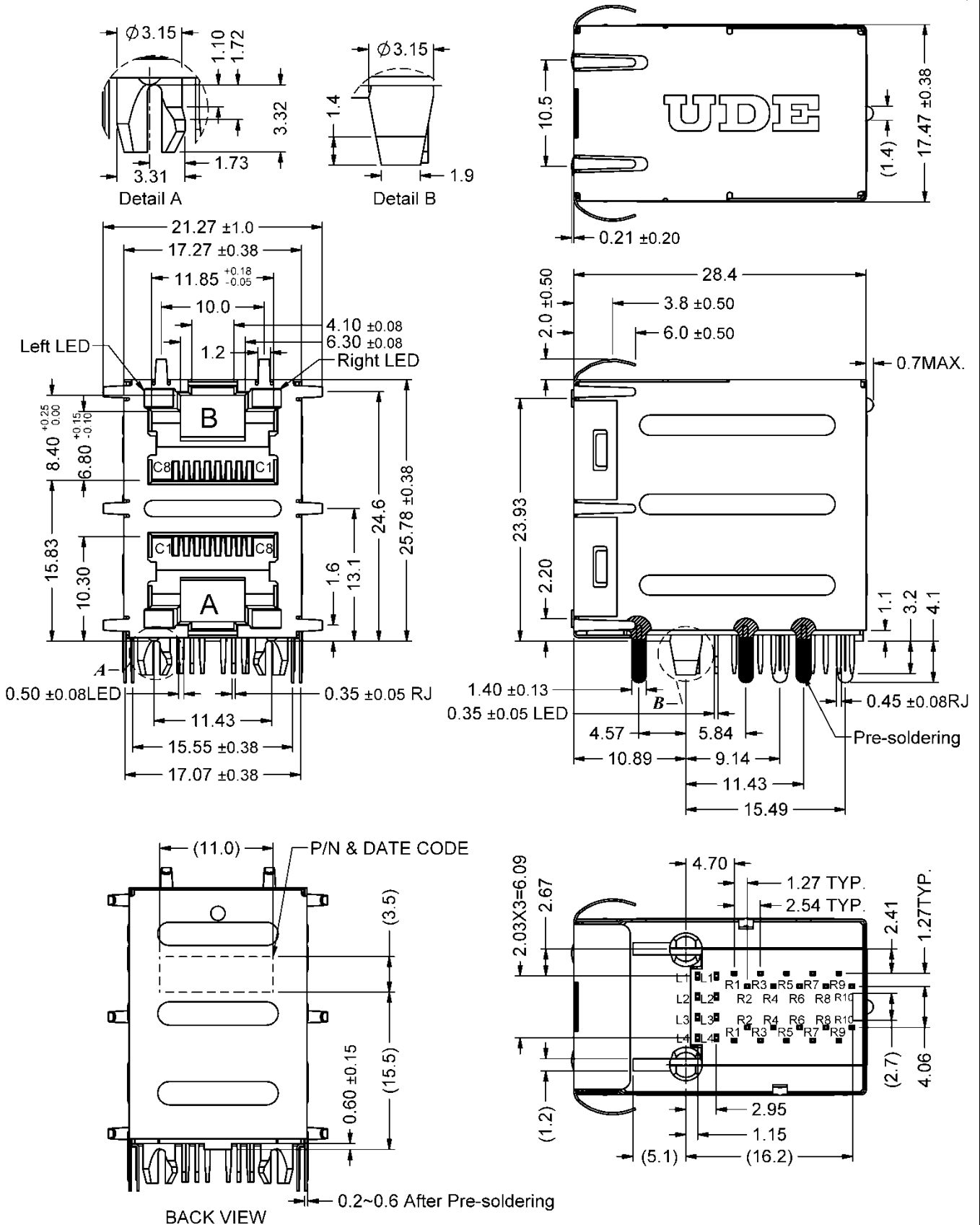

1.2 Recommended PCB Layout

Component Side of Board

All dimension tolerance are $\pm 0.05\text{mm}$ unless otherwise specified

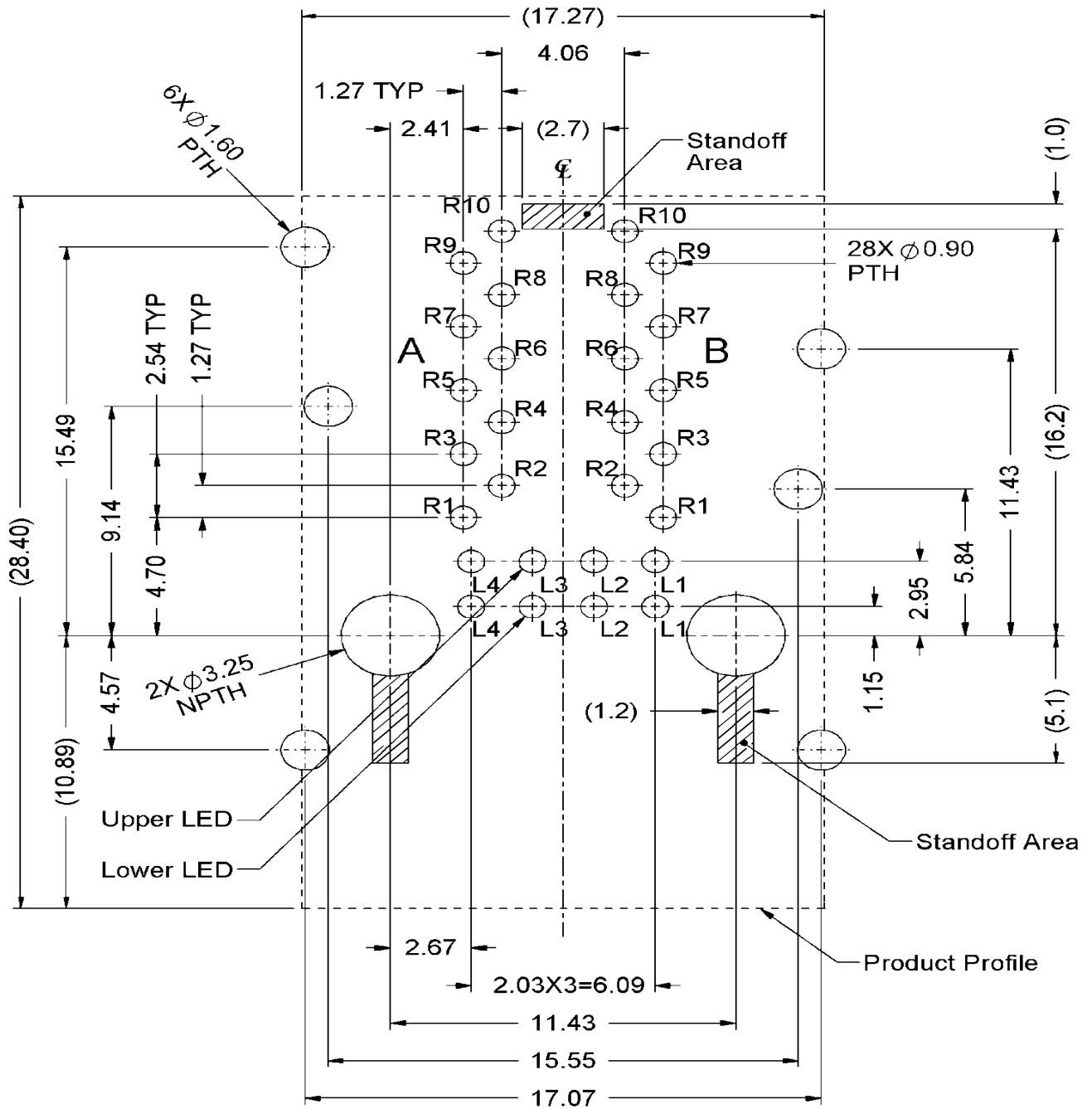

1.3 Packing Information

40 pcs finished goods per tray

5 trays (200 pcs finished goods) per inner box

4 Inner boxes (800 pcs finished goods) per master carton

1.4 Standard RJ45 Plug Specification

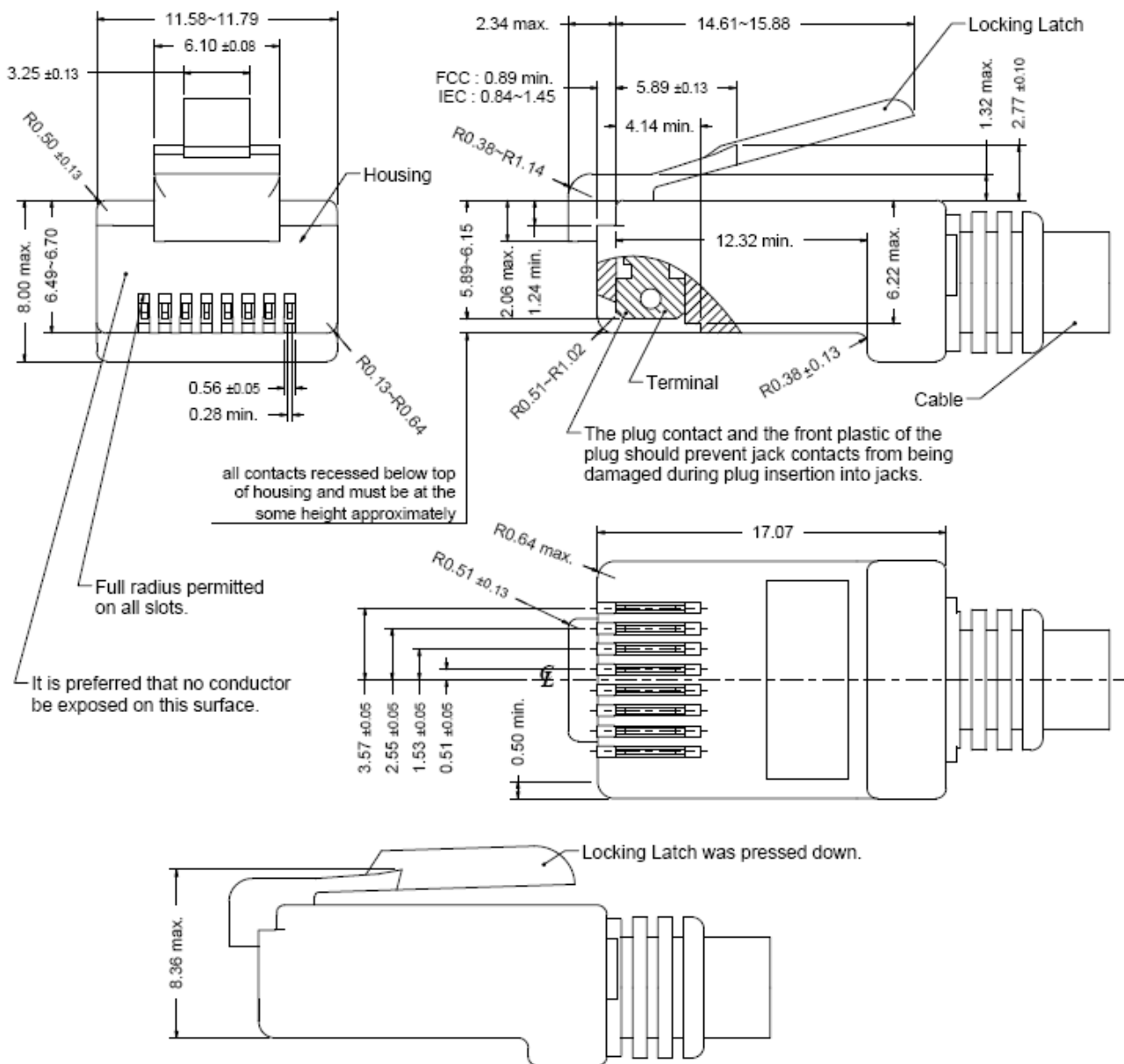

- All dimensions follow :

FCC subpart F, 68,500, Figure (C)(2)(i) & (C)(2)(ii) & (C)(3)(i)

IEC 60603-7

- All plugs must be meeting the requirements of plug Go & No-Go gauge.

Gauge follow : FCC subpart F, 68,500, Figure (C)(4)(i) & (C)(5)(i)

- There must be no damage to Housing and Locking Latch.

- There must be no nicks and cuts in cable.

- Durability : 750 cycles generally

2. REQUIREMENTS

2.1 Design and Construction

Product shall be of design, construction and physical dimensions specified on applicable.

2.2 Material

2.2.1 Terminal Parts (Underplating : 50 μ " min. Nickel overall)

2.2.1.1 RJ Terminal : Copper Titanium Alloy, YCUT-FX-H, Thickness=0.30mm

Finish : Contact Area : 30 μ " Gold

2.2.1.2 Input Terminal : Brass, C2680R-H, Thickness=0.35mm

Finish : 100 μ " min. Tin

2.2.1.3 Case Terminal : Brass, C2680R-SH, Thickness=0.30mm

Finish : 100 μ " min. Tin

2.2.2 Plastic Parts <UL94V-0>

2.2.2.1 Housing : PA6T, Black, 30%, G.F.

2.2.2.2 Case : PA6T, Black, 30%, G.F.

2.2.2.3 Spacer : PA6T, Black, 30%, G.F.

2.2.2.4 Terminal Cover : PA6T, Black, 30%, G.F.

2.2.2.5 Terminal Base : PA6T, Black, 30%, G.F.

2.2.2.6 Insert : PA6T, Black, 30%, G.F.

2.2.2.7 Light Pipe : PC, Transparent.

2.2.3 Shield Parts

2.2.3.1 Front Shield : Stainless, SUS 304R-1/2H, Thickness=0.20mm, unplating

2.2.3.2 Back Shield : Stainless, SUS 304R-1/2H, Thickness=0.20mm, Pre-soldering

2.3 Operating and Storage Temperature

Operating Temperature : 0°C to +70°C

Storage Temperature : -40°C to +85°C

2.4 RJ45 specifications

Insulation Resistance : 500MΩ min.

Insertion force with the latch depressed : 22N max

Removal force with the latch depressed : 44N max

Locking Force of Plug Latch : 50N min. @ 60+/-5 sec

Durability : 2500 cycles

2.5 Performance and Test Description

Product is designed to meet electrical, mechanical and environmental performance requirements specified in below table. All tests are performed at ambient environmental conditions per MIL-STD-1344A and EIA-364 unless otherwise specified.

2.6 Packaging and Packing

All parts shall be packaged and packed to protect against physical damage 、 corrosion and deterioration during shipment and storage.

3. ELECTRICAL CHARACTERISTICS

3.1 Schematic

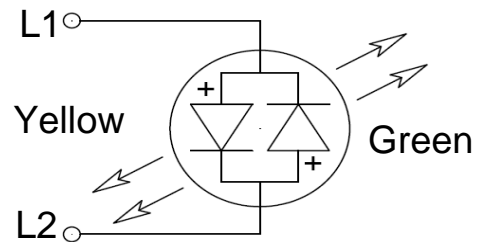
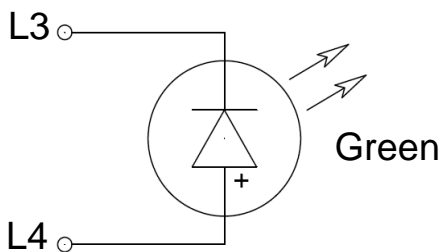
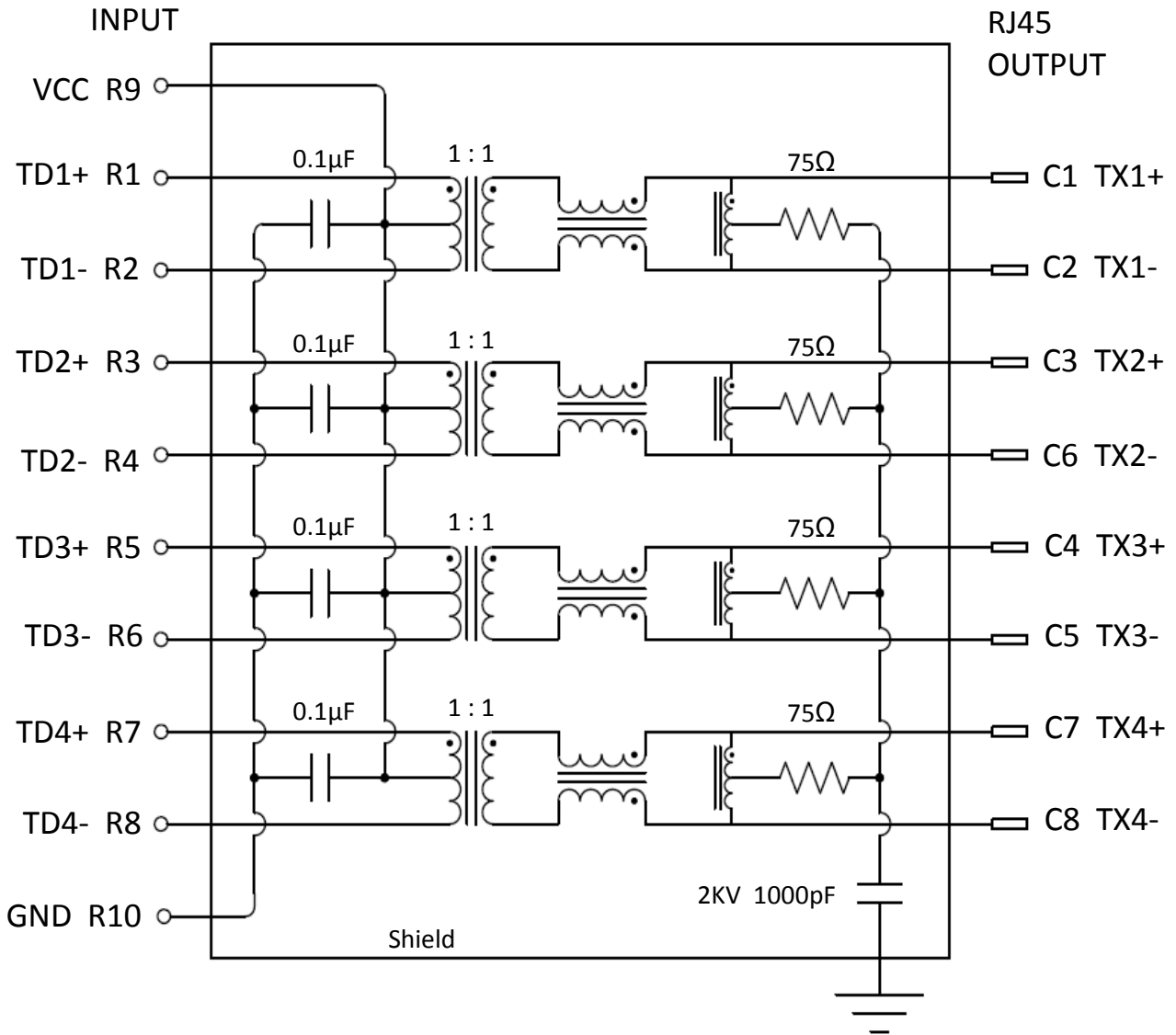

Emitting Color	λ_p (nm)	V_f @ $I_f=20mA$	I_r @ $V_r=5V$
Green	565	1.7 ~2.6 V	10µA max.
Yellow	585	1.7 ~2.6 V	10µA max.

3.2 Transmitter filter & Receiver filter

Type : Balance low pass 100Ω impedance

Insertion loss : 1~100 MHz -1.0dB max.

Return loss : 1~30 MHz -18dB min. load 100Ω

30~60MHz -16dB min. load 100Ω

60~80MHz -12dB min. load 100Ω

80~100MHz -10dB min. load 100Ω

3.3 Common Mode Rejection

@ 1~100 MHz -30dB min.

3.4 Cross Talk

@ 1~100 MHz -30dB min.

3.5 Inductance @ 100KHz, 0.1V, 8mA DC BIAS

Input (R1-R2), Input(R3-R4), Input (R5-R6), Input(R7-R8): 350 μH min.

3.6 HiPot Test

Input(R1-R2) To Output(C1-C2): 1500Vac 60s or 2250Vdc 60s

Input(R3-R4) To Output(C3-C6): 1500Vac 60s or 2250Vdc 60s

Input(R5-R6) To Output(C4-C5): 1500Vac 60s or 2250Vdc 60s

Input(R7-R8) To Output(C7-C8): 1500Vac 60s or 2250Vdc 60s

4. ORDER INFORMATION

R M 3 - 1 3 8A 9V1 F
 A B C D

A. LED Code :

L-Green; R-Green/Yellow. <Refer to Schematic of LED>

B. Mechanical Code :

w/ UDE Logo, w/ Top & Side Spring

C. Schematics Code :

9V1 : 9V1 circuit

D. Plating Code :

Underplating	50μ " min. Nickel overall	
Solder Tail	100μ " min. Bright Tin	100μ " min. Matted Tin
Contact Area	A : Gold Flash C : 6μ " gold B : 10μ " gold D : 15μ " gold <u>F : 30μ " gold</u> G : 50μ " gold	1 : Gold Flash 6 : 6μ " gold 2 : 15μ " gold 3 : 30μ " gold 4 : 50μ " gold

5. DIPPING TEMPERATURE PROFILE

Note :

The measuring point for the specified temperature shall be on the soldered part of the lead.

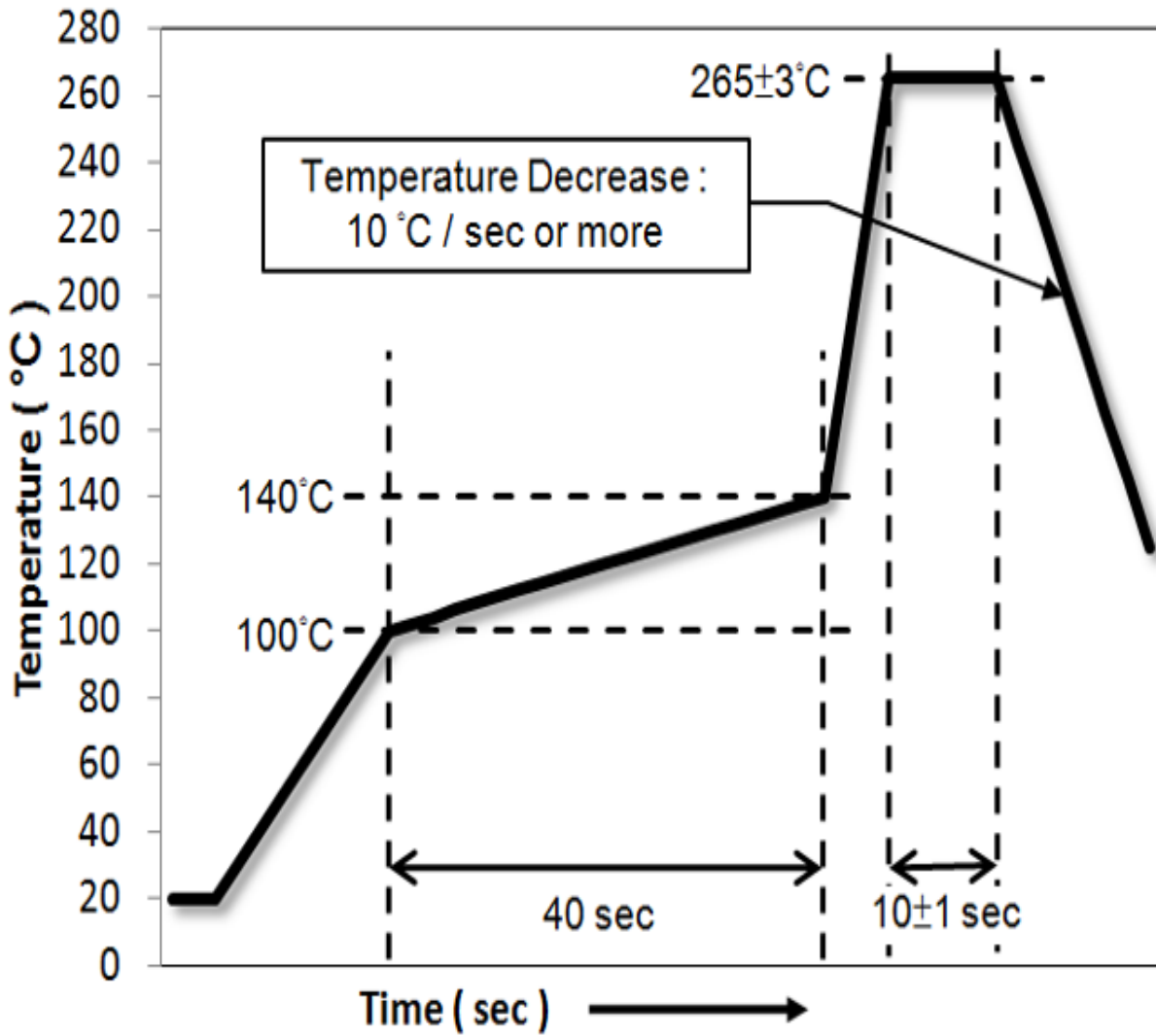

X-ON Electronics

Largest Supplier of Electrical and Electronic Components

Click to view similar products for [Modular Connectors](#) / [Ethernet Connectors](#) category:

Click to view products by [UDE manufacturer](#):

Other Similar products are found below :

[RJE231881317T](#) [MP1010RX-1000](#) [MP44RX-1000](#) [GAX-3-66](#) [GAX-8-62](#) [93606-0253](#) [GD-A-44](#) [GDCX-PA-66-50](#) [GDCX-PN-64](#) [GDCX-PN-66](#) [GDCX-PN-66-50](#) [GDLX-A-66](#) [GDLX-A-88](#) [GDLX-N-66](#) [GDLX-S-88K](#) [GDTX-S-88-50](#) [GDX-PA-1010](#) [GLX-N-1010M-BLK](#) [GLX-N-44M](#) [GLX-S-88M-BLK](#) [GMX-N-1010](#) [GMX-S-1010](#) [GMX-S-66](#) [GMX-SMT2-N-1010](#) [GMX-SMT2-N-64-50](#) [GMX-SMT2-S6-88](#) [GMX-SMT4-N-88](#) [GPX-2-64](#) [GRT1-BT1-5](#) [GSGX-N-2-88](#) [GSX-NS2-88-3.05](#) [GSX-NS2-88-3.05-50](#) [GSX-NS-88-3.05-30](#) [GSX-NS-88-3.05-50](#) [GSX-NS-88-3.68](#) [1-1775629-2](#) [GWLX-S-88-GR](#) [GWLX-S9-88-YG](#) [1300500326](#) [1300500227](#) [1300530003](#) [1300570002](#) [1324640-4](#) [RJ11FTVC2G](#) [RJ11FTVC2N](#) [RJFTVX2SA1G](#) [132764-001](#) [1400000](#) [1413176](#) [1413235](#)