

ONE BOARDLOCK (LEFT)

- NOTE:
- MATERIAL: HOUSING: PA9T, UL94 V-0, COLOR: (SEE TABLE). CONTACTS: BRASS.
 - FINISH: CONTACTS: 3.05um [120u"] MIN. MATTE-TIN. 1.27um [50u"] MIN. NICKEL UNDERPLATED ALL OVER. 3. WAVE SOLDER CAPABLE TO 265°C PER TEST SPEC. 109-202, CONDITION B.
 - NO TE LOGO AND DATE CODE ON THE PRODUCT WITH 4 POS. 5. THE KEY IDENTIFIED WAS SHOWN ON PAGE 5.

HSG COLOR & MATERIAL	WEIGHT	DIM A	DIM B	DIM C	POS.	PART NUMBER
IVORY PA9T	1.92	12.6	17.9	19.95	8	5099-5
	1.52	8.4	13.7	15.75	6	5099-6
	2.31	16.8	22.1	24.15	10	5099-7
	2.71	21.0	26.3	28.35	12	5099-8
	3.11	25.2	30.5	32.55	14	5099-9
	3.90	33.6	38.9	40.95	18	1-5099-0
	4.30	37.8	43.1	45.15	20	1-5099-1
	1.13	4.2	9.5	11.55	4	1-5099-2
	5.40	46.2	51.5	53.55	24	1-5099-3
	1.52	8.4	13.7	15.75	6	6-5099-6

Umax 东莞市友贸实业有限公司 DONGGUAN UMAXCONN ENTERPRISE LIMITED

TITLE: ATX POWER CONNECTOR 4.2mm PITCH, VERTICAL, DIP TYPE

PART NO. SEE TABLE

TOLERANCE: ANGLES X±.40 LINEAR X±0.40

REV	ECN NO.	NAME	DATE	'XXX±	'XXX±	DRWN: Terry	Q'TY:
				X±0.20	X±.40	CHKD: Schuml	FINISH:
				X±0.30	X±.40	APPD: Jason	MAT'L:

DWG NO. C-5099

UNITS: MM

SCALE: 1:1

SHEET: 6

SHEET REV: 0

1	REV	ECON NO.	NAME	DATE	'XXX±	'XX±	'XX±	DRWN: Terry	Q'TY:	6	7	8 CUSTOMER
					X±0.10	X±0.20	X±0.30	CHKD: Schuml	FINISH:			
					X±	X±0.30	X±	APPD: Jason	MAT'L:			
					X±	X±0.40	X±	DONGGUAN UMAXCONN ENTERPRISE LIMITED				
	TOLERANCE		ANGLES	Umax 东莞市外贸实业有限公司								
	LINEAR		TITLE: ATX POWER CONNECTOR									
	PART NO.		SEE TABLE									
	DWG NO.		C-5099									
	REVISION		SCALE SHEET REV									
	DATE		1:1 2 OF 6 0									

PART NUMBER	POS.	DIM C	DIM B	DIM A	WEIGHT	HSG COLOR & MATERIAL
2-5099-0	4	13.6	9.5	4.2	1.16	IVORY PA9T
2-5099-1	6	17.8	13.7	8.4	1.55	
2-5099-2	8	22.0	17.9	12.6	1.95	
2-5099-3	10	26.2	22.1	16.8	2.34	
2-5099-4	12	30.4	26.3	21.0	2.74	
2-5099-5	14	34.6	30.5	25.2	3.14	
2-5099-6	18	43.0	38.9	33.6	3.93	
2-5099-7	20	47.2	43.1	37.8	4.33	
2-5099-8	24	55.6	51.5	46.2	5.43	
2-5099-9	16	38.8	34.7	29.4	3.54	

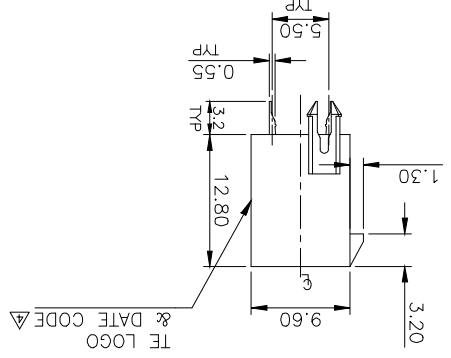
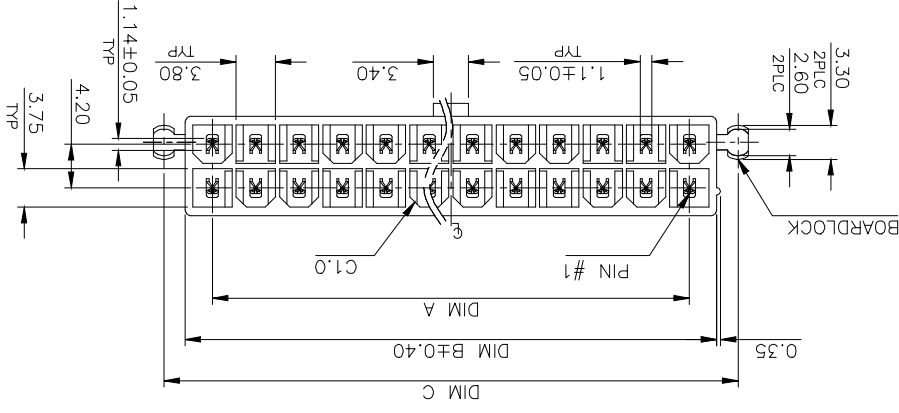
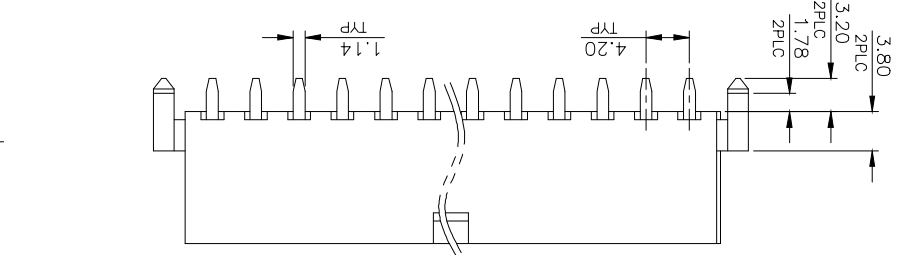
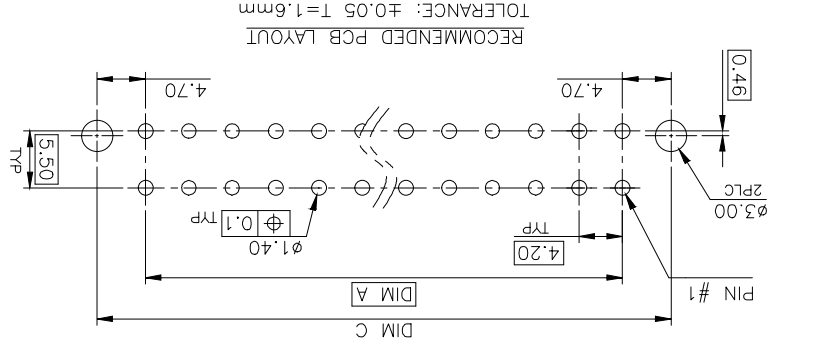

TWO BOARDLOCK

- NOTE:
- 1.MATERIAL: HOUSING: PA9T, UL94 V-0, COLOR: (SEE TABLE). CONTACTS: BRASS.
 2. FINISH: CONTACTS: 3.05um [120u"] MIN. MATTE-TIN. 1.27um [50u"] MIN. NICKEL UNDERPLATED ALL OVER.
 3. WAVE SOLDER CAPABLE TO 265°C PER TEST SPEC. 109-202, CONDITION B.
 4. NO TE LOGO AND DATE CODE ON THE PRODUCT WITH 4 POS.
 5. THE KEY IDENTIFIED WAS SHOWN ON PAGE 5.

1	REV	ECON NO.	NAME	DATE	'XXX±	'XX±	DRWN: Terry	Q'TY:	6	8 CUSTOMER
2					'XX±0.10	'XX±0.20	CHKD: Schuml	FINISH:		
3					'X±	'X±0.30	APPD: Jason	MAT'L:		
4					X±	X±0.40	Umax DONGGUAN UMAGCONN ENTERPRISE LIMITED 东莞市友贸实业有限公司			
5					TOLERANCE					
6	TITLE:		ATX POWER CONNECTOR 4.2mm PITCH, VERTICAL, DIP TYPE		PART NO.		SEE TABLE			
7	MM		1:1	3 OF 6	0	DWG NO. C-5099				

HSG COLOR & MATERIAL	WEIGHT	DIM A	DIM B	DIM C	POS.	PART NUMBER
IVORY PA9T	1.13	4.2	9.5	11.55	4	3-5099-0
	1.52	8.4	13.7	15.75	6	3-5099-1
	1.92	12.6	17.9	19.95	8	3-5099-2
	2.31	16.8	22.1	24.15	10	3-5099-3
	2.71	21.0	26.3	28.35	12	3-5099-4
	3.11	25.2	30.5	32.55	14	3-5099-5
	3.90	33.6	38.9	40.95	18	3-5099-6
	4.30	37.8	43.1	45.15	20	3-5099-7
5.40	46.2	51.5	53.55	24	3-5099-8	

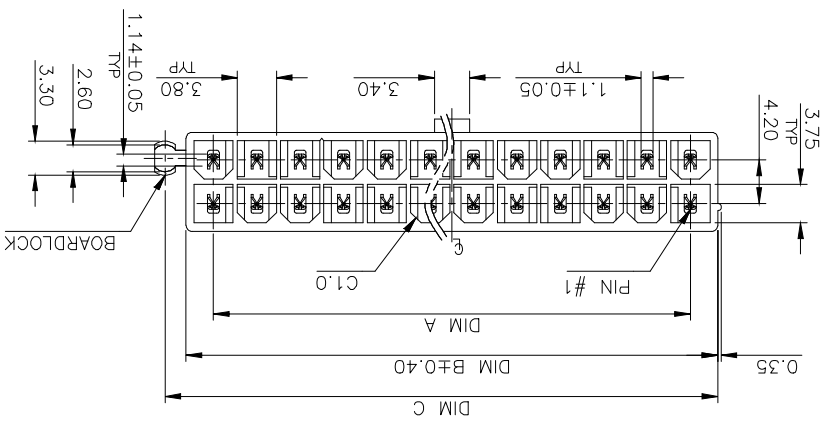
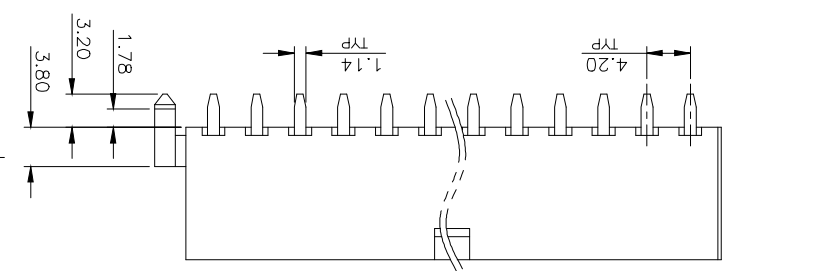
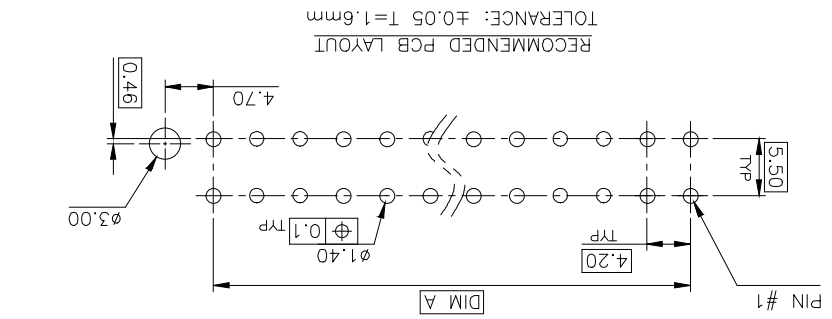

ONE BOARDLOCK (RIGHT)

- NOTE:
- MATERIAL: HOUSING: PA9T, UL94 V-0, COLOR: (SEE TABLE).
 - CONTACTS: BRASS.
 - FINISH: CONTACTS: 3.05um [120u"] MIN. MATTE-TIN.
 - 1.27um [50u"] MIN. NICKEL UNDERPLATED ALL OVER.
 3. WAVE SOLDER CAPABLE TO 265°C PER TEST SPEC.
 - 109-202, CONDITION B.
 - NO TE LOGO AND DATE CODE ON THE PRODUCT WITH 4 POS.
 5. THE KEY IDENTIFIED WAS SHOWN ON PAGE 5.

1	REV	ECON NO.	NAME	DATE	'XXX±	'XX±	'XX±	DRWN: Terry	Q'TY:	6	8 CUSTOMER
2					X±0.10	X±0.20	X±	CHKD: Schuml	FINISH:		
3					X±0.30	X±	X±	APPD: Jason	MAT'L:		
4	TOLERANCE		LINEAR	X±0.40	X±						
5	TOLERANCE		ANGLES	X±							
6	TITLE:		ATX POWER CONNECTOR 4.2mm PITCH, VERTICAL, DIP TYPE								
7	PART NO.		SEE TABLE								
8	DWG NO.		C-5099								
	UNITS		MM								
	SCALE		1:1								
	SHEET		4 OF 6								
	REV		0								

HSG COLOR & MATERIAL	WEIGHT	DIM A	DIM B	POS.	PART NUMBER
IVORY PA9T	1.10	4.2	9.5	4	4-5099-0
	1.49	8.4	13.7	6	4-5099-1
	1.89	12.6	17.9	8	4-5099-2
	2.28	16.8	22.1	10	4-5099-3
	2.68	21.0	26.3	12	4-5099-4
	3.08	25.2	30.5	14	4-5099-5
	3.87	33.6	38.9	18	4-5099-6
	4.27	37.8	43.1	20	4-5099-7
5.37	46.2	51.5	24	4-5099-8	

NOTE:
 1. MATERIAL:
 HOUSING: PA9T, UL94 V-0, COLOR: (SEE TABLE).
 CONTACTS: BRASS.
 2. FINISH:
 CONTACTS: 3.05um [120u"] MIN. MATTE-TIN.
 1.27um [50u"] MIN. NICKEL UNDERPLATED ALL OVER.
 3. WAVE SOLDER CAPABLE TO 265°C PER TEST SPEC.
 109-202, CONDITION B.
 NO TE LOGO AND DATE CODE ON THE PRODUCT WITH 4 POS.
 5. THE KEY IDENTIFIED WAS SHOWN ON PAGE 5.

NO BOARDLOCK

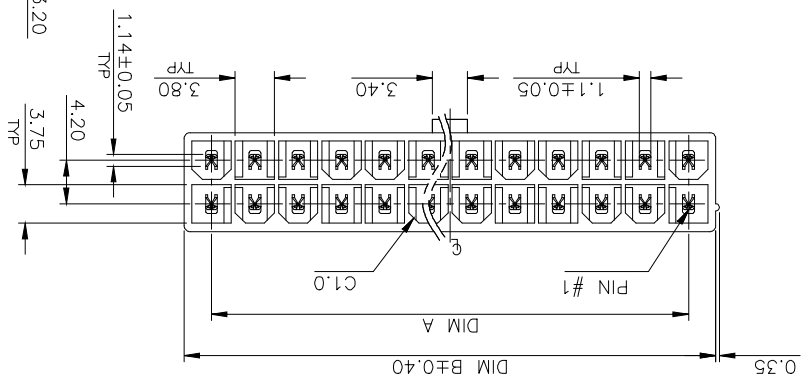
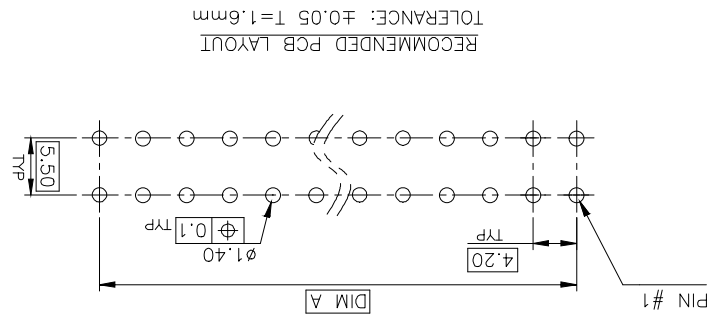
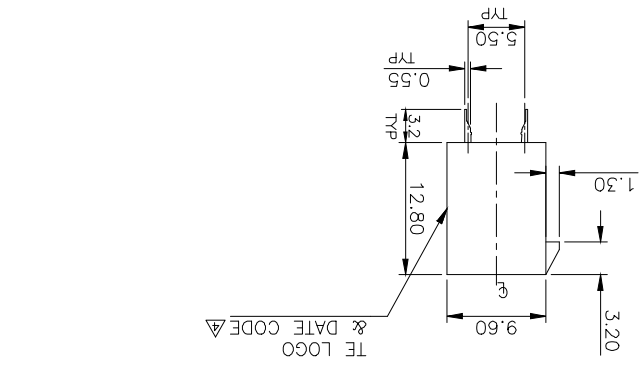

1		2		3		4		5		6		7		8	
REV		ECN NO.		NAME		DATE		XXX±		DRWN: Terry		Q'TY:		CUSTOMER	
								.XX±		CHKD: Schuml		FINISH:		0	
								.X±		APPD: Jason		MAT'L:		5 OF 6	
								X±		DONGGUAN UMAXCONN ENTERPRISE LIMITED		DWG NO. C-5099		MM	
								ANGLES		Umax conn		PART NO. SEE TABLE		1:1	
								TOLERANCE		东莞市友贸实业有限公司		TITLE: ATX POWER CONNECTOR 4.2mm PITCH, VERTICAL, DIP TYPE		SCALE SHEET REV	

KEY POSITION IDENTIFIED
(TOP VIEW)

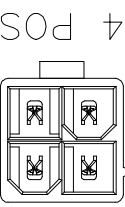
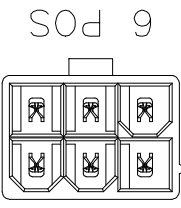
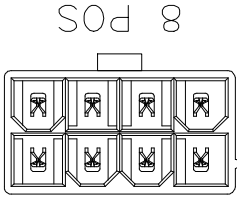
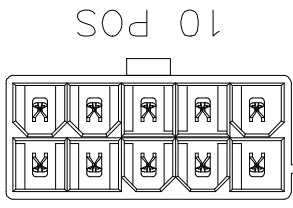
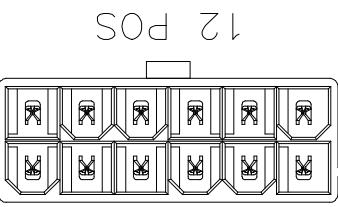
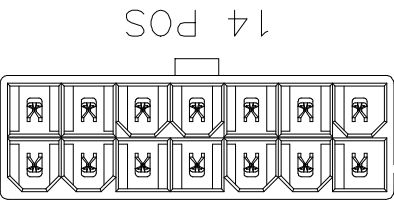
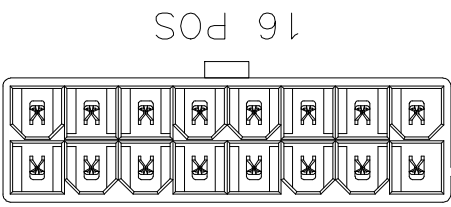
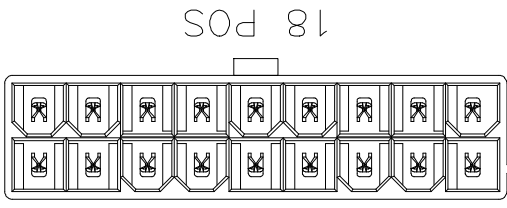
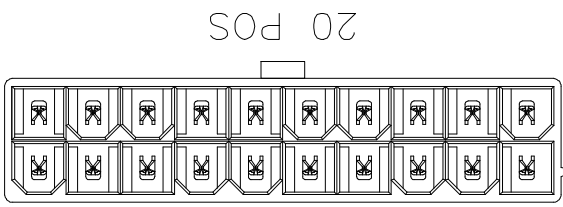
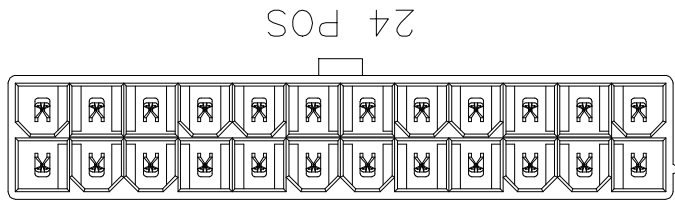

1	REV	ECON NO.	NAME	DATE	'XXX±	'XXX±	DRWN: Terry	Q'TY:	6	7	8
2					'XX±0.20	'XX±	CHKD: Schuml	FINISH:		MM	1:1
3					'X±0.30	'X±	APPD: Jason	MAT'L:		UNITS	SCALE
4					X±0.40	X±	DONGGUAN UMAXCONN ENTERPRISE LIMITED			DWG NO.	C-5099
5	TOLERANCE		ANGLES	LINEAR		UMax 东莞市外贸实业有限公司		DONGGUAN UMAXCONN ENTERPRISE LIMITED		TITLE:	
6	TOLERANCE		ANGLES	LINEAR		UMax 东莞市外贸实业有限公司		DONGGUAN UMAXCONN ENTERPRISE LIMITED		TITLE:	
7	TOLERANCE		ANGLES	LINEAR		UMax 东莞市外贸实业有限公司		DONGGUAN UMAXCONN ENTERPRISE LIMITED		TITLE:	
8	TOLERANCE		ANGLES	LINEAR		UMax 东莞市外贸实业有限公司		DONGGUAN UMAXCONN ENTERPRISE LIMITED		TITLE:	

NO. OF BOARDLOCK	POS.	PCS /BOX	TRAYS /BOX	PCS /TRAY	WEIGHT NET	WEIGHT GROSS	0		1		2	
							4	6	4	6	4	6
4		4800	10	480	5.28	6.88	4	6	4	6	4	6
6		3400	10	340	5.07	6.67	6	8	6	8	6	8
8		2600	10	260	4.91	6.51	8	10	8	12	8	10
10		2000	10	200	4.56	6.16	10	12	10	14	10	12
12		1800	10	180	4.82	6.42	12	14	12	16	12	14
14		1400	10	140	4.51	5.91	14	16	14	18	14	16
18		1200	10	120	4.64	6.24	18	20	18	24	18	20
20		1000	10	100	4.27	5.87	20	24	20	24	20	24
24		800	10	80	4.50	5.90	24	28	24	28	24	28
4		4200	10	420	4.75	6.35	4	6	4	6	4	6
6		3000	10	300	4.56	6.16	6	8	6	10	6	8
8		2400	10	240	4.61	6.21	8	10	8	12	8	10
10		2000	10	200	4.62	6.22	10	12	10	14	10	12
12		1600	10	160	4.34	5.94	12	14	12	16	12	14
14		1400	10	140	4.55	5.95	14	16	14	18	14	16
18		1200	10	120	4.68	6.28	18	20	18	22	18	20
20		1000	10	100	4.30	5.90	20	24	20	24	20	24
24		800	10	80	4.52	5.92	24	28	24	28	24	28
4		3600	10	360	4.18	5.78	4	6	4	6	4	6
6		2800	10	280	4.34	5.94	6	8	6	10	6	8
8		2200	10	220	4.29	5.89	8	10	8	12	8	10
10		1800	10	180	4.21	5.81	10	12	10	14	10	12
12		1600	10	160	4.38	5.98	12	14	12	16	12	14
14		1400	10	140	4.40	6.00	14	16	14	18	14	16
16		1200	10	120	4.25	5.85	16	18	16	20	16	18
18		1000	10	100	3.93	5.53	18	20	18	22	18	20
20		1000	10	100	4.53	5.93	20	24	20	24	20	24
24		800	10	80	4.54	5.94	24	28	24	28	24	28

1	REV	ECON NO.	NAME	DATE	'XXX±	'XXX±	DRWN: Terry	Q'TY:	6	7	8
2					'XX±0.20	'XX±	CHKD: Schuml	FINISH:		MM	1:1
3					'X±0.30	'X±	APPD: Jason	MAT'L:		UNITS	SCALE
4					X±0.40	X±	DONGGUAN UMAXCONN ENTERPRISE LIMITED			DWG NO.	C-5099
5	TOLERANCE		ANGLES	LINEAR		UMax 东莞市外贸实业有限公司		DONGGUAN UMAXCONN ENTERPRISE LIMITED		TITLE:	
6	TOLERANCE		ANGLES	LINEAR		UMax 东莞市外贸实业有限公司		DONGGUAN UMAXCONN ENTERPRISE LIMITED		TITLE:	
7	TOLERANCE		ANGLES	LINEAR		UMax 东莞市外贸实业有限公司		DONGGUAN UMAXCONN ENTERPRISE LIMITED		TITLE:	
8	TOLERANCE		ANGLES	LINEAR		UMax 东莞市外贸实业有限公司		DONGGUAN UMAXCONN ENTERPRISE LIMITED		TITLE:	

NOTES:
 1. TRAY : PVC, SIZE:350mm(L)X 265mm(W)X 22mm(H);
 2. BOX : CORRUGATED, SIZE: 350mm(L)X 279mm(W)X 195mm(H).
 3. QUANTITY: SEE TABLE.

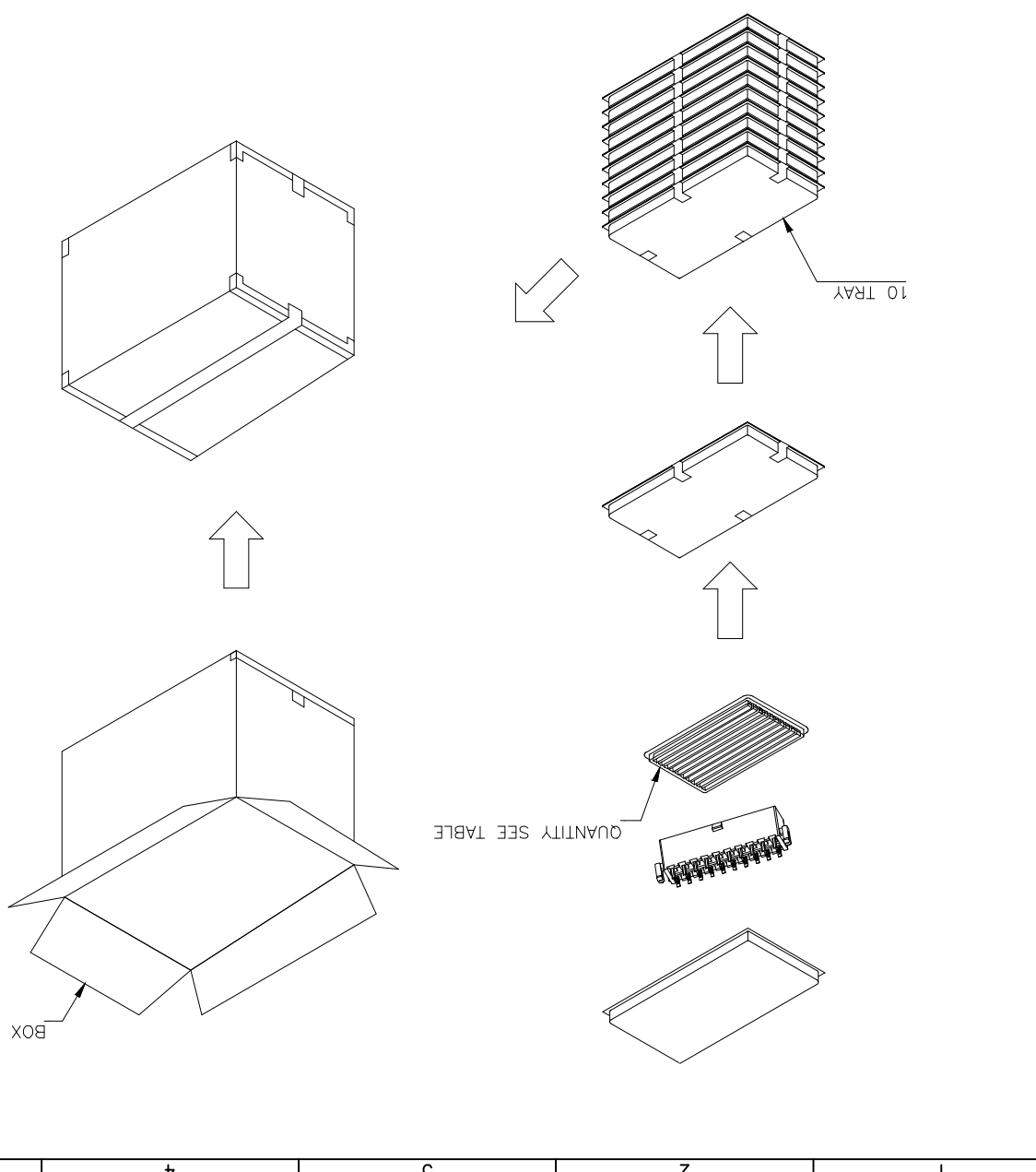

X-ON Electronics

Largest Supplier of Electrical and Electronic Components

Click to view similar products for [Headers & Wire Housings](#) category:

Click to view products by [UMAX](#) manufacturer:

Other Similar products are found below :

[95000-104TRLF](#) [10135584-644402LF](#) [DF62W-EP2022PCA](#) [95000-106TRLF](#) [DF62W-2022SCA](#) [DF62W-EP2022PC](#) [2203348](#) [DF62W-2022SC](#) [1084018](#) [1029039](#) [1084017](#) [802-10-012-10-002000](#) [1112640](#) [1112639](#) [891-007-9SS-BST1T](#) [000-34000](#) [0008550134](#) [0009482033](#) [0009507031](#) [57102-F02-18ULF](#) [57102-S06-03LF](#) [57202-S52-04LF](#) [PCN6-15S-2.5E](#) [0039019024](#) [58102-G61-06LF](#) [582553-1](#) [0009485154](#) [0009508121](#) [0022285053](#) [0050291907](#) [018731A](#) [LY20-4P-DT1-P1E-BR](#) [02.125.8002.8](#) [60101931](#) [60598-1 \(Cut Strip\)](#) [M1625-3R/100](#) [61062-3](#) [61082-181009](#) [CSU011177004](#) [636-1427](#) [638009-1](#) [641938-9](#) [641991-4](#) [644168-1](#) [644827-2](#) [647662-1](#) [65039-019ELF](#) [65692-001LF](#) [65781-018](#) [65781-047](#)