

ONE BOARDLOCK (LEFT)

- NOTE:  
 1. MATERIAL:  
 HOUSING: PA9T, UL94 V-0, COLOR: (SEE TABLE).  
 CONTACTS: BRASS.  
 2. FINISH:  
 CONTACTS: 3.05um [120u"] MIN. MATTE-TIN.  
 1.27um [50u"] MIN. NICKEL UNDERPLATED ALL OVER.  
 3. WAVE SOLDER CAPABLE TO 265°C PER TEST SPEC.  
 109-202, CONDITION B.  
 NO TE LOGO AND DATE CODE ON THE PRODUCT WITH 4 POS.  
 TE LOGO & DATE CODE ▲

HSG COLOR & MATERIAL	WEIGHT	DIM A	DIM B	DIM C	POS.	PART NUMBER
IVORY PA9T	1.92	12.6	17.9	19.95	8	5099-5
	1.52	8.4	13.7	15.75	6	5099-6
	2.31	16.8	22.1	24.15	10	5099-7
	2.71	21.0	26.3	28.35	12	5099-8
	3.11	25.2	30.5	32.55	14	5099-9
	3.90	33.6	38.9	40.95	18	1-5099-0
	4.30	37.8	43.1	45.15	20	1-5099-1
	1.13	4.2	9.5	11.55	4	1-5099-2
	5.40	46.2	51.5	53.55	24	1-5099-3
	1.52	8.4	13.7	15.75	6	6-5099-6

TOLERANCE		TITLE:	
ANGLES	X±	ATX POWER CONNECTOR	
LINEAR	X±0.40	4.2mm PITCH, VERTICAL, DIP TYPE	
PART NO. SEE TABLE		DONGGUAN UMAXCONN ENTERPRISE LIMITED	

REV	ECN NO.	NAME	DATE	'XXX±	'XXX±	DRWN:	Q'TY:
				X±0.20	X±	CHKD: Schuml	FINISH:
				X±0.30	X±	APPD: Jason	MAT'L:
				X±0.40	X±		

REV	SHEET	SCALE	1:1	I DF	6
					0

8 CUSTOMER

1	REV	EEN NO.	NAME	DATE	'XXX±	'XX±	DRWN: Terry	Q'TY:	6	7	8 CUSTOMER
					'X±0.20	'X±0.30	CHKD: Schuml	FINISH:			
					'X±0.40	'X±	APPD: Jason	MAT'L:			
TOLERANCE		LINEAR		X±		DONGGUAN UMAXCONN ENTERPRISE LIMITED		PART NO.		SEE TABLE	
ANGLES						Umax 东莞市友贸实业有限公司		TITLE:		ATX POWER CONNECTOR 4.2mm PITCH, VERTICAL, DIP TYPE	

HSG COLOR & MATERIAL	WEIGHT	DIM A	DIM B	DIM C	POS.	PART NUMBER
IVORY PA9T	1.16	4.2	9.5	13.6	4	2-5099-0
	1.55	8.4	13.7	17.8	6	2-5099-1
	1.95	12.6	17.9	22.0	8	2-5099-2
	2.34	16.8	22.1	26.2	10	2-5099-3
	2.74	21.0	26.3	30.4	12	2-5099-4
	3.14	25.2	30.5	34.6	14	2-5099-5
	3.93	33.6	38.9	43.0	18	2-5099-6
	4.33	37.8	43.1	47.2	20	2-5099-7
	5.43	46.2	51.5	55.6	24	2-5099-8
	3.54	29.4	34.7	38.8	16	2-5099-9

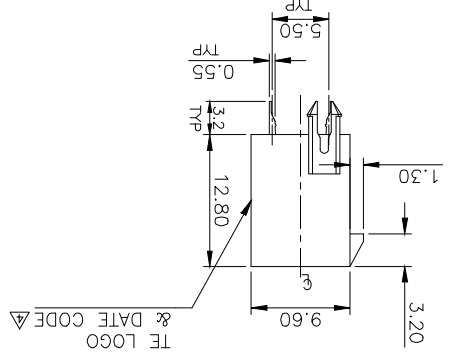
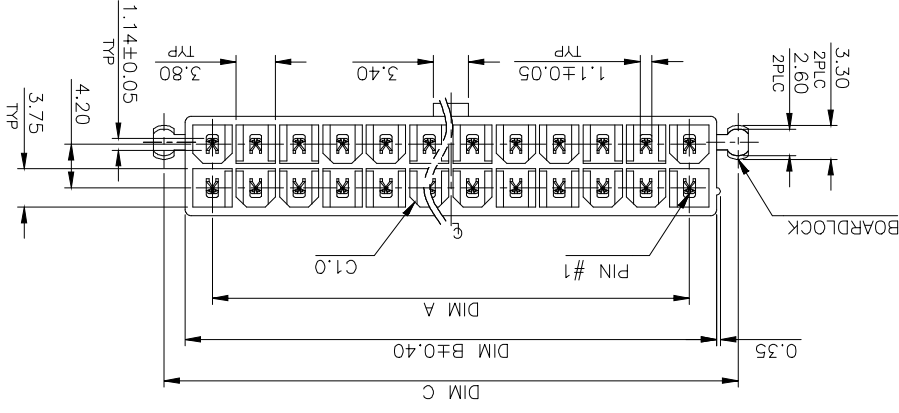
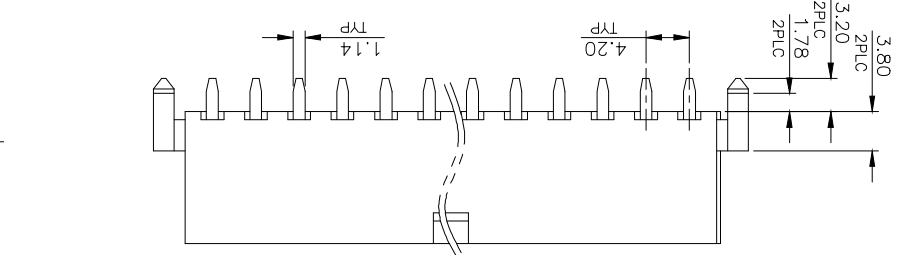
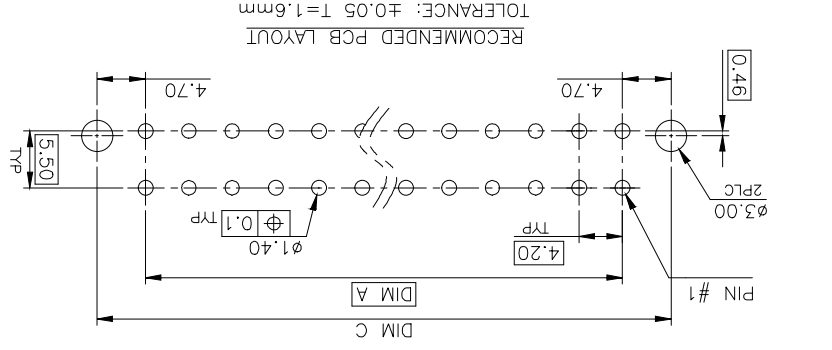

TWO BOARDLOCK

- NOTE:
- MATERIAL: HOUSING: PA9T, UL94 V-0, COLOR: (SEE TABLE). CONTACTS: BRASS.
  - FINISH: CONTACTS: 3.05um [120u"] MIN. MATTE-TIN. 1.27um [50u"] MIN. NICKEL UNDERPLATED ALL OVER.
  - WAVE SOLDER CAPABLE TO 265°C PER TEST SPEC. 109-202, CONDITION B.
  - NO TE LOGO AND DATE CODE ON THE PRODUCT WITH 4 POS.
  - THE KEY IDENTIFIED WAS SHOWN ON PAGE 5.

1	REV	ECON NO.	NAME	DATE	'XXX±	'XX±	DRWN: Terry	Q'TY:	6	8 CUSTOMER
2					'XX±0.10	'XX±0.20	CHKD: Schuml	FINISH:		
3					'X±	'X±0.30	APPD: Jason	MAT'L:		
4					X±	X±0.40	<b>Umax</b> 东莞市友贸实业有限公司 DONGGUAN UMAGONN ENTERPRISE LIMITED <b>conn</b>			
5	TOLERANCE		ANGLES	LINEAR	TITLE: ATX POWER CONNECTOR 4.2mm PITCH, VERTICAL, DIP TYPE					
6	TOLERANCE		ANGLES	LINEAR	PART NO. SEE TABLE					
7	TOLERANCE		ANGLES	LINEAR	DWG NO. C-5099					
8	TOLERANCE		ANGLES	LINEAR	UNITS SCALE SHEET REV					

HSG COLOR & MATERIAL	WEIGHT	DIM A	DIM B	DIM C	POS.	PART NUMBER
IVORY PA9T	1.13	4.2	9.5	11.55	4	3-5099-0
	1.52	8.4	13.7	15.75	6	3-5099-1
	1.92	12.6	17.9	19.95	8	3-5099-2
	2.31	16.8	22.1	24.15	10	3-5099-3
	2.71	21.0	26.3	28.35	12	3-5099-4
	3.11	25.2	30.5	32.55	14	3-5099-5
	3.90	33.6	38.9	40.95	18	3-5099-6
	4.30	37.8	43.1	45.15	20	3-5099-7
5.40	46.2	51.5	53.55	24	3-5099-8	

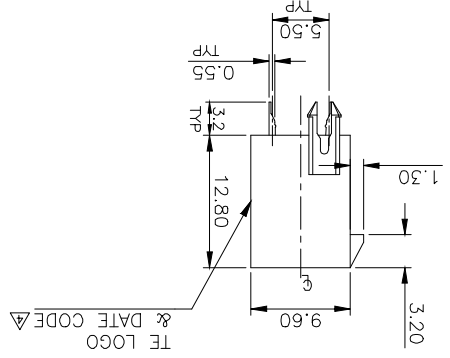
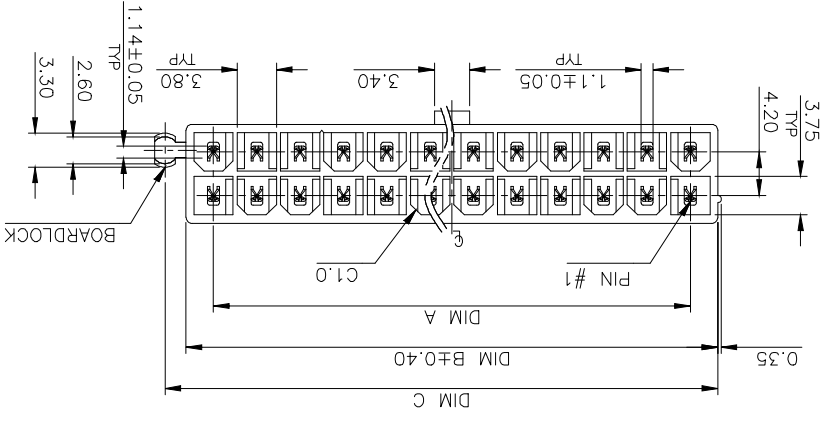
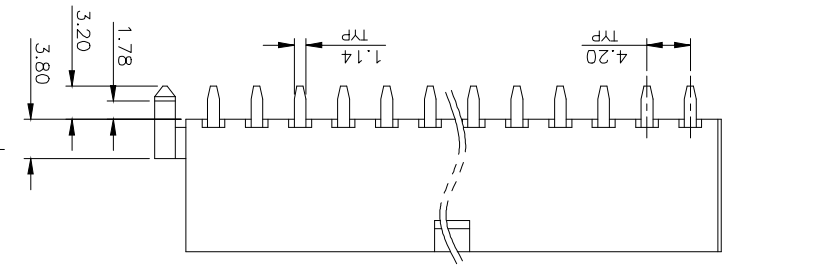
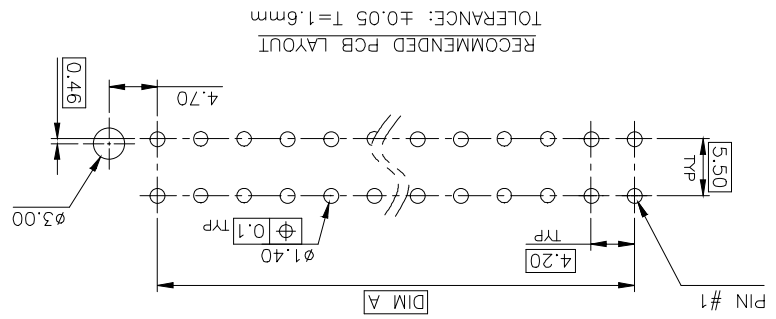

ONE BOARDLOCK (RIGHT)

- NOTE:
- MATERIAL: HOUSING: PA9T, UL94 V-0, COLOR: (SEE TABLE). CONTACTS: BRASS.
  - FINISH: CONTACTS: 3.05um [120u"] MIN. MATTE-TIN.
  - WAVE SOLDER CAPABLE TO 265°C PER TEST SPEC. 1.27um [50u"] MIN. NICKEL UNDERPLATED ALL OVER.
  - NO TE LOGO AND DATE CODE ON THE PRODUCT WITH 4 POS.
  - THE KEY IDENTIFIED WAS SHOWN ON PAGE 5.

1	REV	ECN NO.	NAME	DATE	'XXX±	'XX±	'XX±	DRWN: Terry	QTY:		
2					X±0.10	X±0.20	X±	CHKD: Schuml	FINISH:		
3					X±0.30	X±	X±	APPD: Jason	MATL:	DWG NO. C-5099	
4	TOLERANCE		LINEAR	X±0.40	X±						
5	DONGGUAN UMAXCONN ENTERPRISE LIMITED		UMax		DONGGUAN UMAXCONN ENTERPRISE LIMITED						
6	TITLE:		ATX POWER CONNECTOR 4.2mm PITCH, VERTICAL, DIP TYPE								
7	PART NO.		SEE TABLE								
8	HSG COLOR & MATERIAL		C-5099								

PART NO.	POS.	DIM B	DIM A	WEIGHT	HSG COLOR & MATERIAL
4-5099-0	4	9.5	4.2	1.10	IVORY PA9T
4-5099-1	6	13.7	8.4	1.49	
4-5099-2	8	17.9	12.6	1.89	
4-5099-3	10	22.1	16.8	2.28	
4-5099-4	12	26.3	21.0	2.68	
4-5099-5	14	30.5	25.2	3.08	
4-5099-6	18	38.9	33.6	3.87	
4-5099-7	20	43.1	37.8	4.27	
4-5099-8	24	51.5	46.2	5.37	

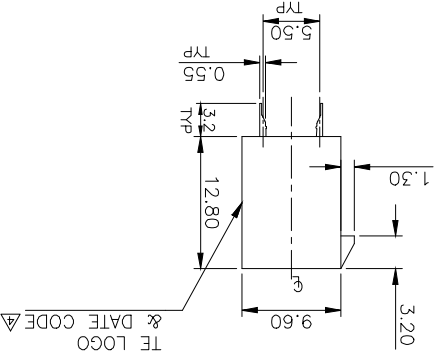
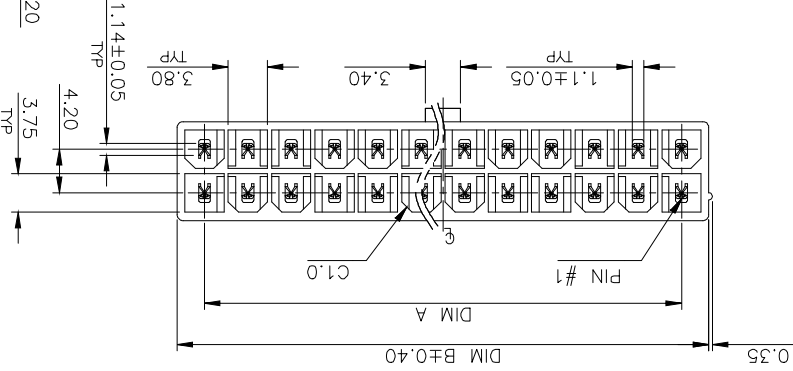
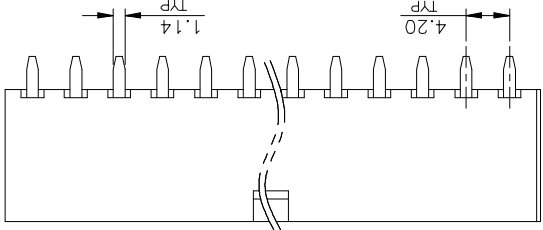
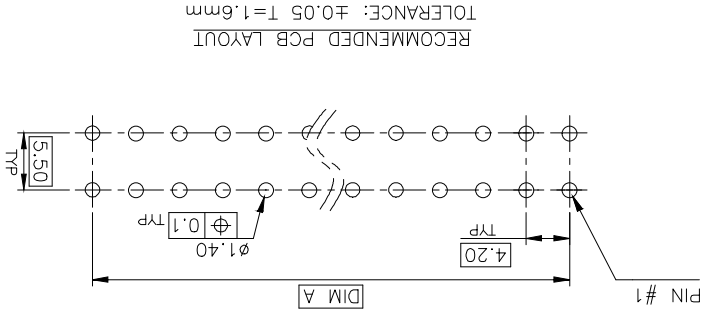

NO BOARDLOCK

- NOTE:
- MATERIAL: HOUSING: PA9T, UL94 V-0, COLOR: (SEE TABLE). CONTACTS: BRASS.
  - FINISH: CONTACTS: 3.05um [120u"] MIN. MATTE-TIN.
  - WAVE SOLDER CAPABLE TO 265°C PER TEST SPEC. 1.27um [50u"] MIN. NICKEL UNDERPLATED ALL OVER.
  - NO TE LOGO AND DATE CODE ON THE PRODUCT WITH 4 POS. 109-202, CONDITION B.
  - THE KEY IDENTIFIED WAS SHOWN ON PAGE 5.

REV		ECN NO.	NAME	DATE	.XXX±0.10	.XX±	CHKD: Schumi	FINISH:	MATL:	DWG NO.	C-5099	SCALE	SHEET	REV
TOLERANCE		LINEAR	ANGLES	X±	X±	X±	APPD: Jason	DRWN: Terry	Q'TY:	MM	1:1	5 OF 6	0	
TITLE:		ATX POWER CONNECTOR 4.2mm PITCH, VERTICAL, DIP TYPE												
PART NO.		SEE TABLE												
Umax DONGGUAN UMAXCONN ENTERPRISE LIMITED		Umax DONGGUAN UMAXCONN ENTERPRISE LIMITED												
TERRANCE		TERRANCE												

KEY POSITION IDENTIFIED  
(TOP VIEW)

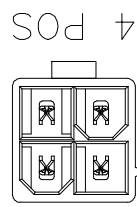
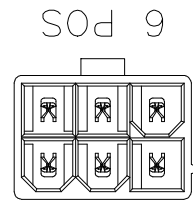
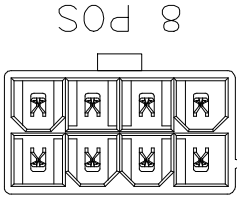
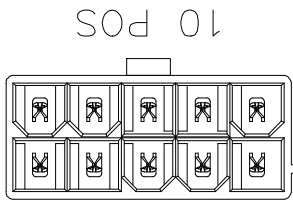
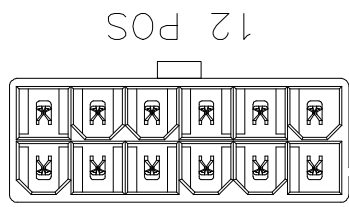
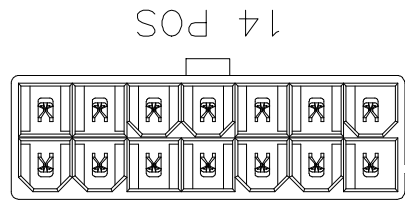
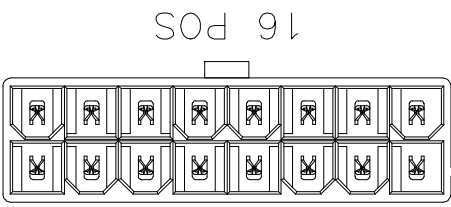
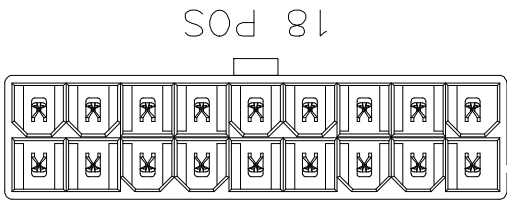
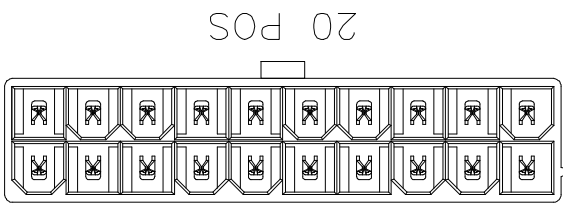
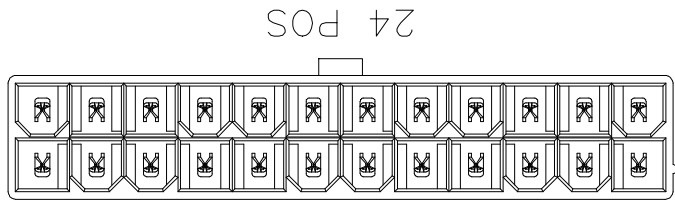

1	REV	ECON NO.	NAME	DATE	'XXX±	'XXX±	DRWN: Terry	Q'TY:	6	7	8
2					'XX±0.20	'XX±	CHKD: Schuml	FINISH:			
3					'X±0.30	'X±	APPD: Jason	MAT'L:			
4					X±0.40	X±	<b>Umax</b> 东莞市友贸实业有限公司 <b>conn</b> DONGGUAN UMXXGONN ENTERPRISE LIMITED		TITLE: ATX POWER CONNECTOR 4.2mm PITCH, VERTICAL, DIP TYPE		
5	TOLERANCE		ANGLES						PART NO. SEE TABLE DWG NO. C-5099		
6											
7											
8											

NO. OF BOARDLOCK	POS.	PCS /BOX	TRAYS /BOX	PCS /TRAY	WEIGHT NET	WEIGHT GROSS	0		1		2										
							4	6	4	6	4	6	8	10	12	14	16	18	20	24	
4		4800	10	480	5.28	6.88	4	6	4	6	4	6	8	10	12	14	16	18	20	24	
6		3400	10	340	5.07	6.67	6	8	6	8	6	8	8	10	12	14	16	18	20	24	
8		2600	10	260	4.91	6.51	8	10	8	10	8	10	10	12	14	16	18	20	24	24	
10		2000	10	200	4.56	6.16	10	12	10	12	10	12	12	14	16	18	20	24	24	24	
12		1800	10	180	4.82	6.42	12	14	12	14	12	14	14	16	18	20	24	24	24	24	
14		1400	10	140	4.51	5.91	14	16	14	16	14	16	16	18	20	24	24	24	24	24	
18		1200	10	120	4.64	6.24	18	20	18	20	18	20	18	20	20	24	24	24	24	24	
20		1000	10	100	4.27	5.87	20	24	20	24	20	24	20	24	20	24	24	24	24	24	
24		800	10	80	4.50	5.90	24	24	24	24	24	24	24	24	24	24	24	24	24	24	
4		4200	10	420	4.75	6.35	4	6	4	6	4	6	6	8	10	12	14	16	18	20	24
6		3000	10	300	4.56	6.16	6	8	6	8	6	8	8	10	12	14	16	18	20	24	24
8		2400	10	240	4.61	6.21	8	10	8	10	8	10	10	12	14	16	18	20	24	24	24
10		2000	10	200	4.62	6.22	10	12	10	12	10	12	12	14	16	18	20	24	24	24	24
12		1600	10	160	4.34	5.94	12	14	12	14	12	14	14	16	18	20	24	24	24	24	24
14		1400	10	140	4.55	5.95	14	16	14	16	14	16	16	18	20	24	24	24	24	24	24
18		1200	10	120	4.68	6.28	18	20	18	20	18	20	18	20	20	24	24	24	24	24	24
20		1000	10	100	4.30	5.90	20	24	20	24	20	24	20	24	20	24	24	24	24	24	24
24		800	10	80	4.52	5.92	24	24	24	24	24	24	24	24	24	24	24	24	24	24	24
4		3600	10	360	4.18	5.78	4	6	4	6	4	6	6	8	10	12	14	16	18	20	24
6		2800	10	280	4.34	5.94	6	8	6	8	6	8	8	10	12	14	16	18	20	24	24
8		2200	10	220	4.29	5.89	8	10	8	10	8	10	10	12	14	16	18	20	24	24	24
10		1800	10	180	4.21	5.81	10	12	10	12	10	12	12	14	16	18	20	24	24	24	24
12		1600	10	160	4.38	5.98	12	14	12	14	12	14	14	16	18	20	24	24	24	24	24
14		1400	10	140	4.40	6.00	14	16	14	16	14	16	16	18	20	24	24	24	24	24	24
16		1200	10	120	4.25	5.85	16	18	16	18	16	18	18	20	24	24	24	24	24	24	24
18		1000	10	100	3.93	5.53	18	20	18	20	18	20	18	20	20	24	24	24	24	24	24
20		1000	10	100	4.53	5.93	20	24	20	24	20	24	20	24	20	24	24	24	24	24	24
24		800	10	80	4.54	5.94	24	24	24	24	24	24	24	24	24	24	24	24	24	24	24

1	REV	ECON NO.	NAME	DATE	'XXX±	'XXX±	DRWN: Terry	Q'TY:	6	7	8
2					'XX±0.20	'XX±	CHKD: Schuml	FINISH:			
3					'X±0.30	'X±	APPD: Jason	MAT'L:			
4					X±0.40	X±	<b>Umax</b> 东莞市友贸实业有限公司 <b>conn</b> DONGGUAN UMXXGONN ENTERPRISE LIMITED		TITLE: ATX POWER CONNECTOR 4.2mm PITCH, VERTICAL, DIP TYPE		
5	TOLERANCE		ANGLES						PART NO. SEE TABLE DWG NO. C-5099		
6											
7											
8											

NOTES:  
 1. TRAY : PVC, SIZE:350mm(L)X 265mm(W)X 22mm(H).  
 2. BOX : CORRUGATED, SIZE: 350mm(L)X 279mm(W)X 195mm(H).  
 3. QUANTITY: SEE TABLE.

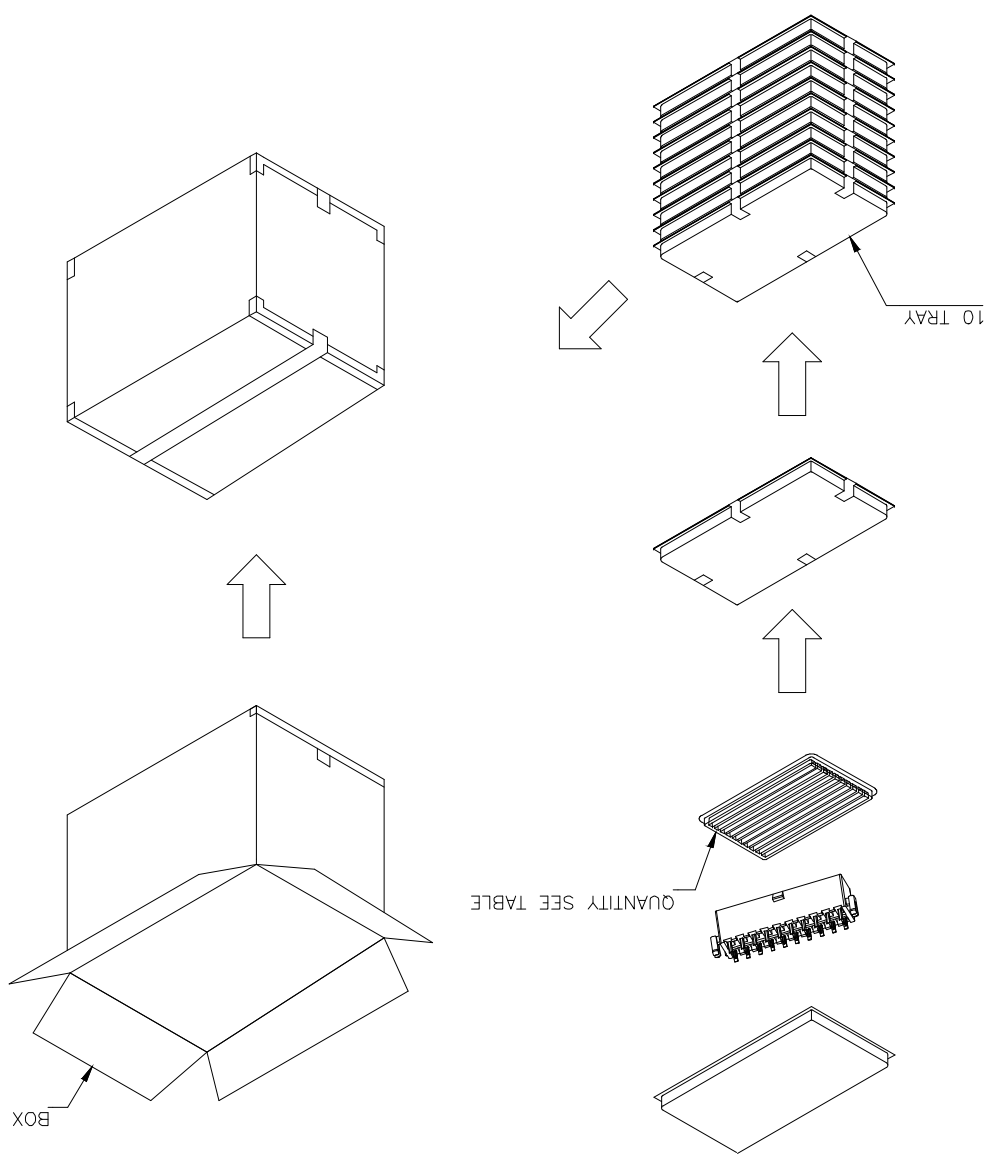

## X-ON Electronics

Largest Supplier of Electrical and Electronic Components

*Click to view similar products for [Headers & Wire Housings](#) category:*

*Click to view products by [UMAX](#) manufacturer:*

Other Similar products are found below :

[95000-104TRLF](#) [10135584-644402LF](#) [DF62W-EP2022PCA](#) [95000-106TRLF](#) [DF62W-2022SCA](#) [DF62W-EP2022PC](#) [2203348](#) [DF62W-2022SC](#) [1084018](#) [1029039](#) [1084017](#) [802-10-012-10-002000](#) [1112640](#) [1112639](#) [891-007-9SS-BST1T](#) [000-34000](#) [0008550134](#) [0009482033](#) [0009507031](#) [57102-F02-18ULF](#) [57102-S06-03LF](#) [57202-S52-04LF](#) [PCN6-15S-2.5E](#) [0039019024](#) [58102-G61-06LF](#) [582553-1](#) [0009485154](#) [0009508121](#) [0022285053](#) [0050291907](#) [018731A](#) [LY20-4P-DT1-P1E-BR](#) [02.125.8002.8](#) [60101931](#) [60598-1 \(Cut Strip\)](#) [M1625-3R/100](#) [61062-3](#) [61082-181009](#) [CSU011177004](#) [636-1427](#) [638009-1](#) [641938-9](#) [641991-4](#) [644168-1](#) [644827-2](#) [647662-1](#) [65039-019ELF](#) [65692-001LF](#) [65781-018](#) [65781-047](#)