



# 650V N-Channel MOSFET

## FEATURES

- Fast switching
- 100% avalanche tested
- Improved dv/dt capability

## APPLICATIONS

- Switch Mode Power Supply (SMPS)
- Uninterruptible Power Supply (UPS)
- Power Factor Correction (PFC)

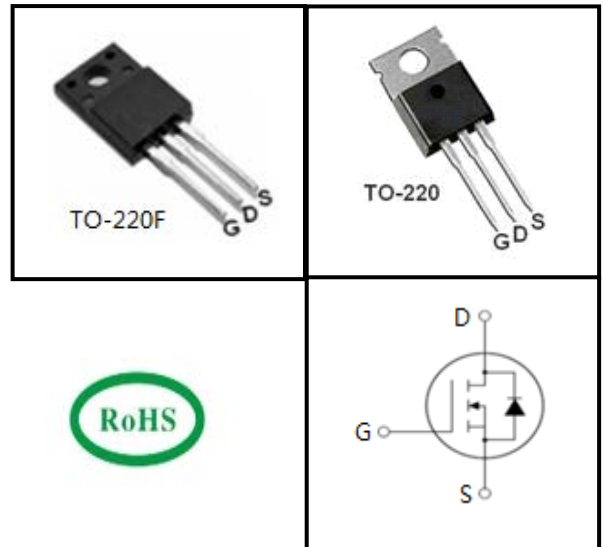

| Device Marking and Package Information |         |         |
|--|---------|---------|
| Device                                 | Package | Marking |
| TMA20N65H                              | TO-220F | A20N65H |
| TMP20N65H                              | TO-220  | P20N65H |

| Absolute Maximum Ratings $T_C = 25^\circ\text{C}$ , unless otherwise noted |                |          |        |                  |
|--|----------------|----------|--------|------------------|
| Parameter  | Symbol         | Value    |        | Unit             |
|  |                | TO-220F  | TO-220 |                  |
| Drain-Source Voltage ( $V_{GS} = 0\text{V}$ )                              | $V_{DSS}$      | 650      |        | V                |
| Continuous Drain Current   | $I_D$          | 20       |        | A                |
| Pulsed Drain Current (note1)   | $I_{DM}$       | 80       |        | A                |
| Gate-Source Voltage  | $V_{GSS}$      | $\pm 30$ |        | V                |
| Single Pulse Avalanche Energy (note2)                                      | $E_{AS}$       | 1350     |        | mJ               |
| Avalanche Current (note1)  | $I_{AR}$       | 16       |        | A                |
| Repetitive Avalanche Energy (note1)  | $E_{AR}$       | 90       |        | mJ               |
| Power Dissipation ( $T_C = 25^\circ\text{C}$ )                             | $P_D$          | 120      | 416    | W                |
| Operating Junction and Storage Temperature Range                           | $T_J, T_{stg}$ | -55~+150 |        | $^\circ\text{C}$ |

| Thermal Resistance                      |            |         |        |                           |
|---|------------|---------|--------|---------------------------|
| Parameter                               | Symbol     | Value   |        | Unit                      |
|   |            | TO-220F | TO-220 |                           |
| Thermal Resistance, Junction-to-Case    | $R_{thJC}$ | 1.04    | 0.3    | $^\circ\text{C}/\text{W}$ |
| Thermal Resistance, Junction-to-Ambient | $R_{thJA}$ | 62.5    | 60     |                           |



| Specifications $T_J = 25^\circ\text{C}$ , unless otherwise noted |               |  |       |      |           |          |
|--|---------------|--|-------|------|-----------|----------|
| Parameter  | Symbol        | Test Conditions  | Value |      |           | Unit     |
|  |               |  | Min.  | Typ. | Max.      |          |
| <b>Static</b>  |               |  |       |      |           |          |
| Drain-Source Breakdown Voltage                                   | $V_{(BR)DSS}$ | $V_{GS} = 0V, I_D = 250\mu A$                            | 650   | --   | --        | V        |
| Zero Gate Voltage Drain Current                                  | $I_{DSS}$     | $V_{DS} = 650V, V_{GS} = 0V, T_J = 25^\circ\text{C}$     | --    | --   | 1         | $\mu A$  |
| Gate-Source Leakage  | $I_{GSS}$     | $V_{GS} = \pm 30V$                                       | --    | --   | $\pm 100$ | nA       |
| Gate-Source Threshold Voltage                                    | $V_{GS(th)}$  | $V_{DS} = V_{GS}, I_D = 250\mu A$                        | 3.0   | --   | 4.0       | V        |
| Drain-Source On-Resistance (Note3)                               | $R_{DS(on)}$  | $V_{GS} = 10V, I_D = 10A$                                | --    | 0.35 | 0.45      | $\Omega$ |
| <b>Dynamic</b>   |               |  |       |      |           |          |
| Input Capacitance  | $C_{iss}$     | $V_{GS} = 0V,$<br>$V_{DS} = 25V,$<br>$f = 1.0\text{MHz}$ | --    | 2978 | --        | pF       |
| Output Capacitance   | $C_{oss}$     |  | --    | 291  | --        |          |
| Reverse Transfer Capacitance                                     | $C_{rss}$     |  | --    | 40   | --        |          |
| Total Gate Charge  | $Q_g$         | $V_{DD} = 520V, I_D = 20A,$<br>$V_{GS} = 10V$            | --    | 80   | --        | nC       |
| Gate-Source Charge   | $Q_{gs}$      |  | --    | 12   | --        |          |
| Gate-Drain Charge  | $Q_{gd}$      |  | --    | 34   | --        |          |
| Turn-on Delay Time   | $t_{d(on)}$   | $V_{DD} = 325V, I_D = 20A,$<br>$R_G = 25\Omega$          | --    | 37   | --        | ns       |
| Turn-on Rise Time  | $t_r$         |  | --    | 66   | --        |          |
| Turn-off Delay Time  | $t_{d(off)}$  |  | --    | 175  | --        |          |
| Turn-off Fall Time   | $t_f$         |  | --    | 84   | --        |          |
| <b>Drain-Source Body Diode Characteristics</b>                   |               |  |       |      |           |          |
| Continuous Body Diode Current                                    | $I_S$         | $T_C = 25^\circ\text{C}$                                 | --    | --   | 20        | A        |
| Pulsed Diode Forward Current                                     | $I_{SM}$      |  | --    | --   | 80        |          |
| Body Diode Voltage   | $V_{SD}$      | $T_J = 25^\circ\text{C}, I_{SD} = 20A, V_{GS} = 0V$      | --    | --   | 1.4       | V        |
| Reverse Recovery Time  | $t_{rr}$      | $V_{GS} = 0V, I_S = 20A,$<br>$di_F/dt = 100A/\mu s$      | --    | 450  | --        | ns       |
| Reverse Recovery Charge  | $Q_{rr}$      |  | --    | 7.1  | --        | $\mu C$  |

**Notes**

1. Repetitive Rating: Pulse width limited by maximum junction temperature
2.  $I_{AS} = 16A, V_{DD} = 50V, R_G = 25\Omega$ , Starting  $T_J = 25^\circ\text{C}$
3. Pulse Test: Pulse width  $\leq 350\mu s$ , Duty Cycle  $\leq 1\%$



Typical Characteristics  $T_J = 25^\circ\text{C}$ , unless otherwise noted

Figure 1. Output Characteristics ( $T_J = 25^\circ\text{C}$ )

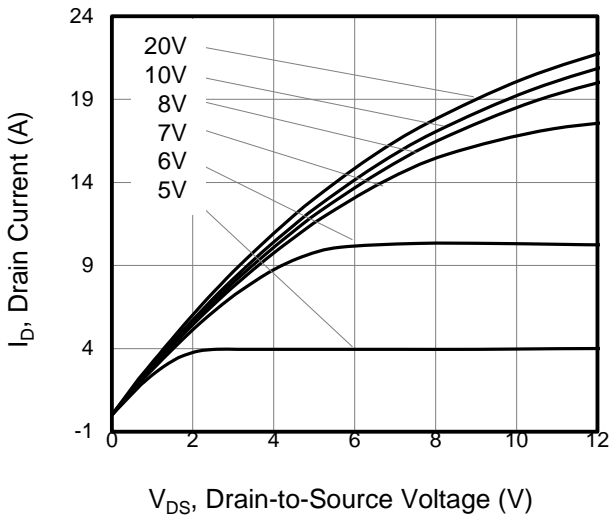

Figure 2. Body Diode Forward Voltage

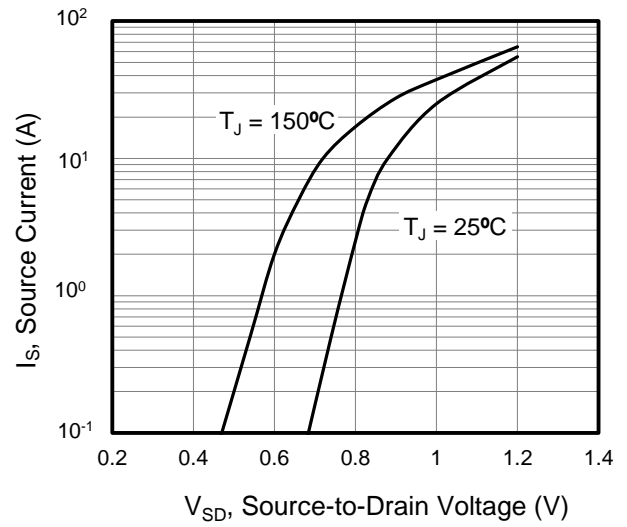

Figure 3. Drain Current vs. Temperature

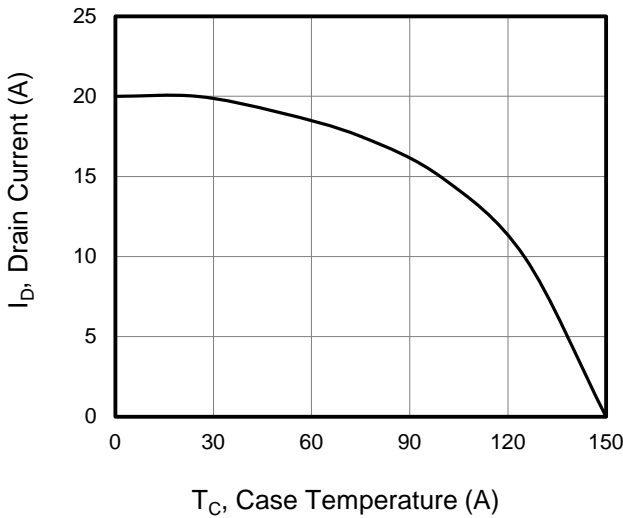

Figure 4.  $BV_{DSS}$  Variation vs. Temperature

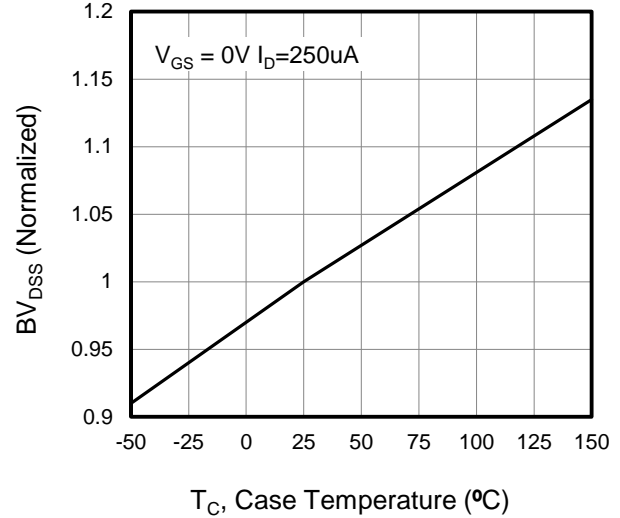

Figure 5. Transfer Characteristics

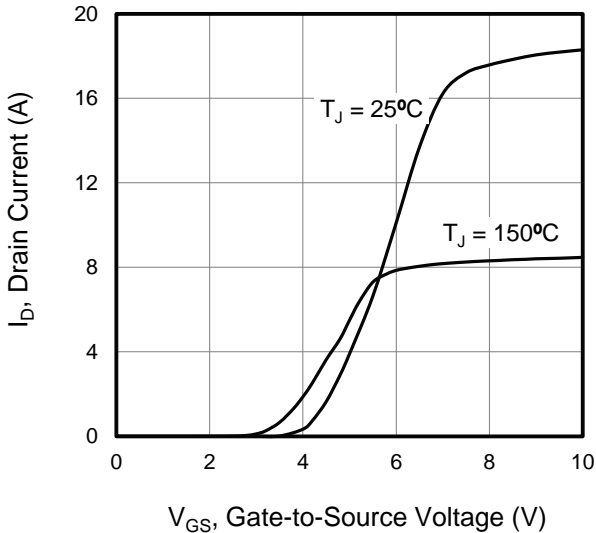
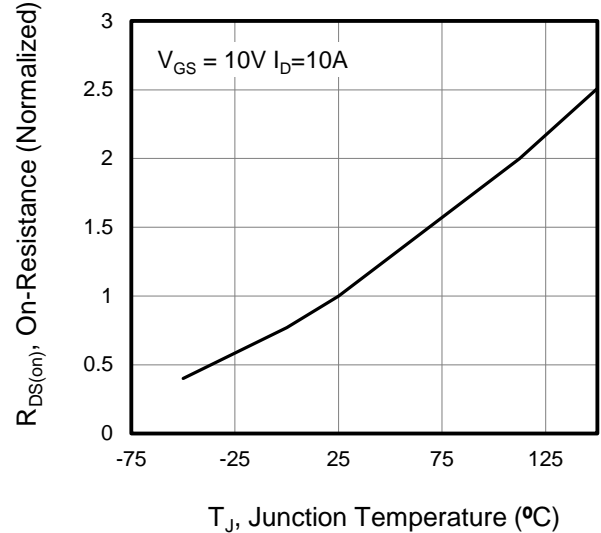

Figure 6. On-Resistance vs. Temperature





Typical Characteristics  $T_j = 25^\circ\text{C}$ , unless otherwise noted

Figure 7. Capacitance

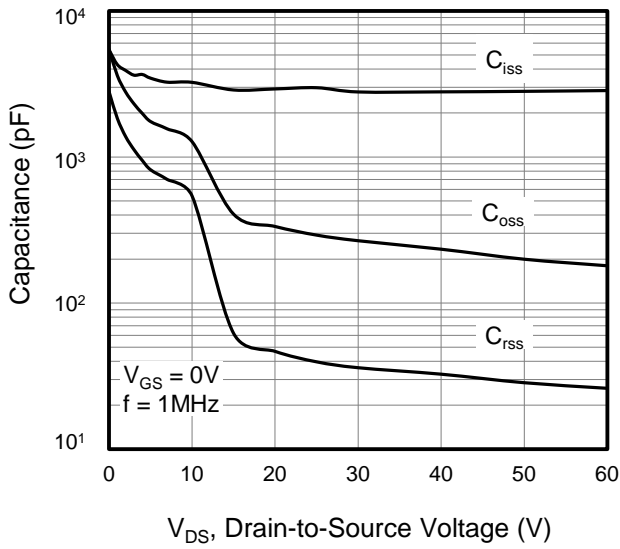

Figure 8. Gate Charge

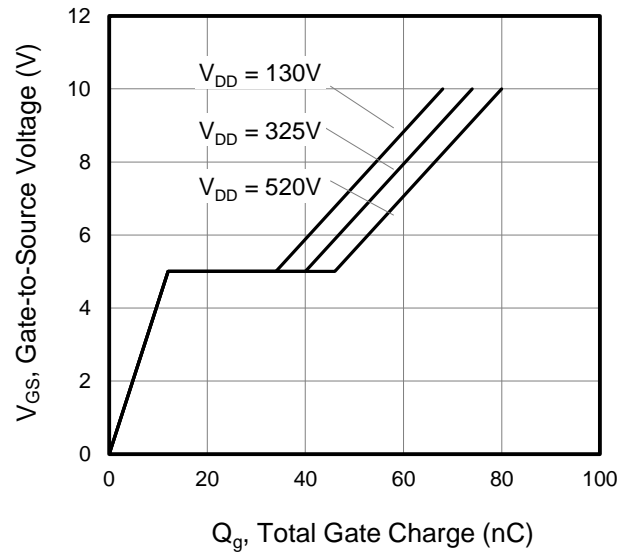

Figure 9. Transient Thermal Impedance

TO-220F

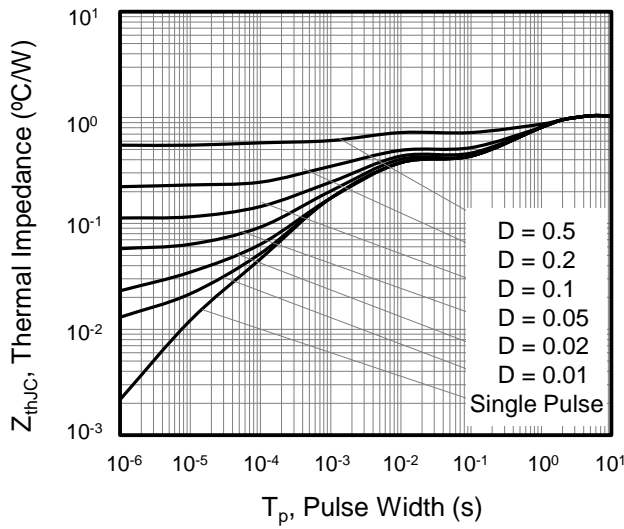

Figure 10. Transient Thermal Impedance

TO-220

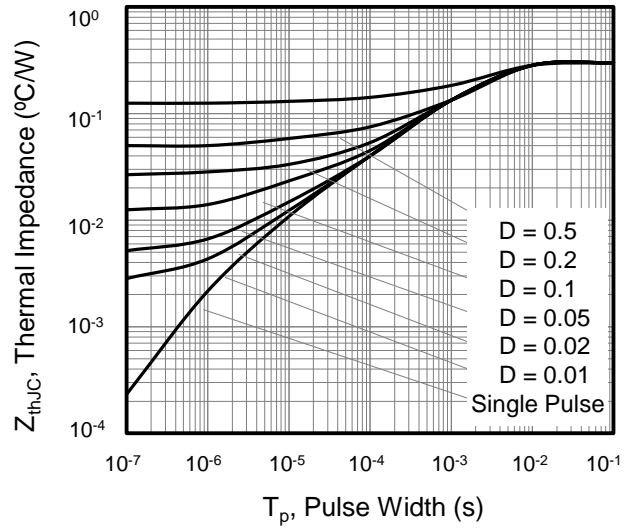



Figure A: Gate Charge Test Circuit and Waveform

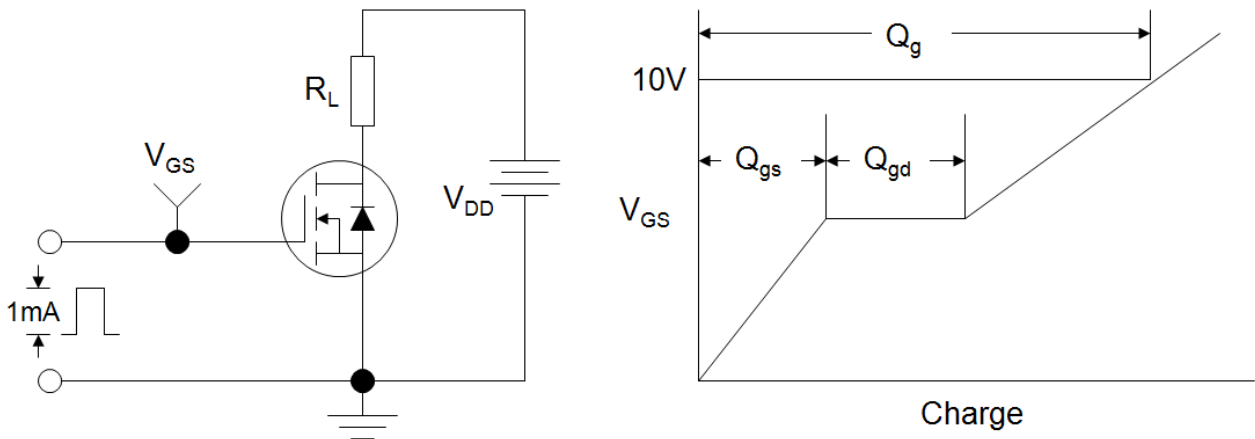

Figure B: Resistive Switching Test Circuit and Waveform

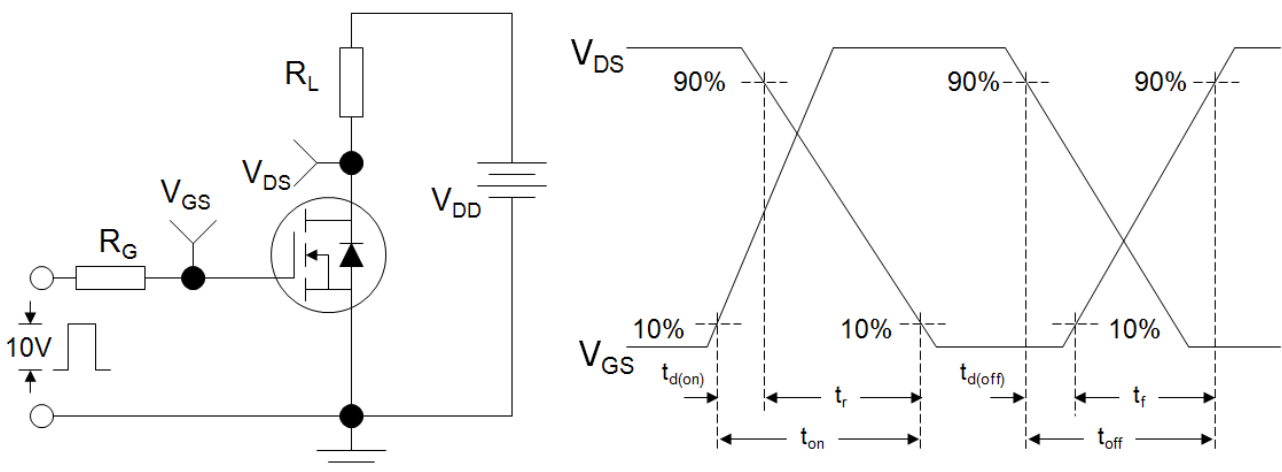
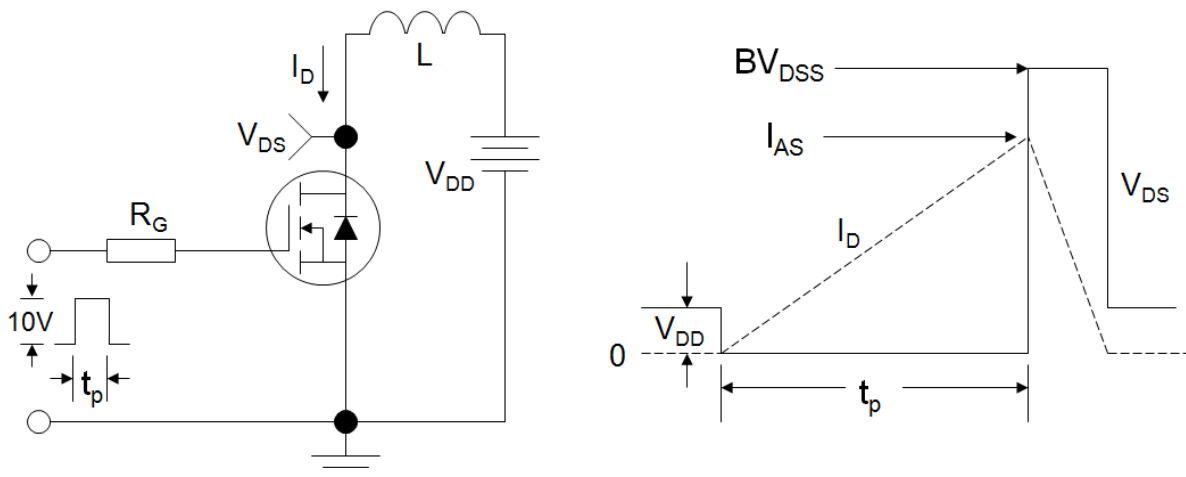
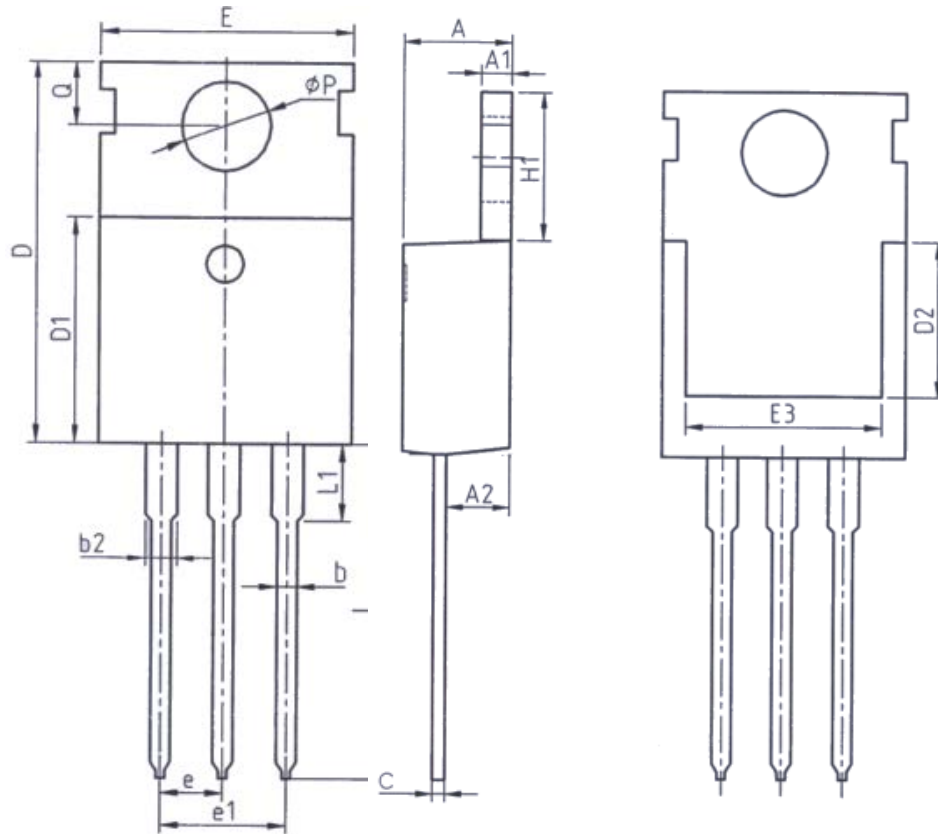

Figure C: Unclamped Inductive Switching Test Circuit and Waveform





### TO-220



| Unit: mm |       |       |
|----------|-------|-------|
| Symbol   | Min.  | Max.  |
| A        | 4.37  | 4.77  |
| A1       | 1.25  | 1.45  |
| A2       | 2.20  | 2.60  |
| b        | 0.70  | 0.95  |
| b2       | 1.17  | 1.47  |
| c        | 0.40  | 0.65  |
| D        | 15.10 | 16.10 |
| D1       | 8.80  | 9.40  |
| D2       | 5.50  | -     |

| Unit: mm |         |       |
|----------|---------|-------|
| Symbol   | Min.    | Max.  |
| E        | 9.70    | 10.30 |
| E3       | 7.00    | -     |
| e        | 2.54BSC |       |
| e1       | 5.08BSC |       |
| H1       | 6.25    | 6.85  |
| L        | 12.75   | 13.80 |
| L1       | -       | 3.40  |
| P        | 3.40    | 3.80  |
| Q        | 2.60    | 3.00  |



### TO-220F

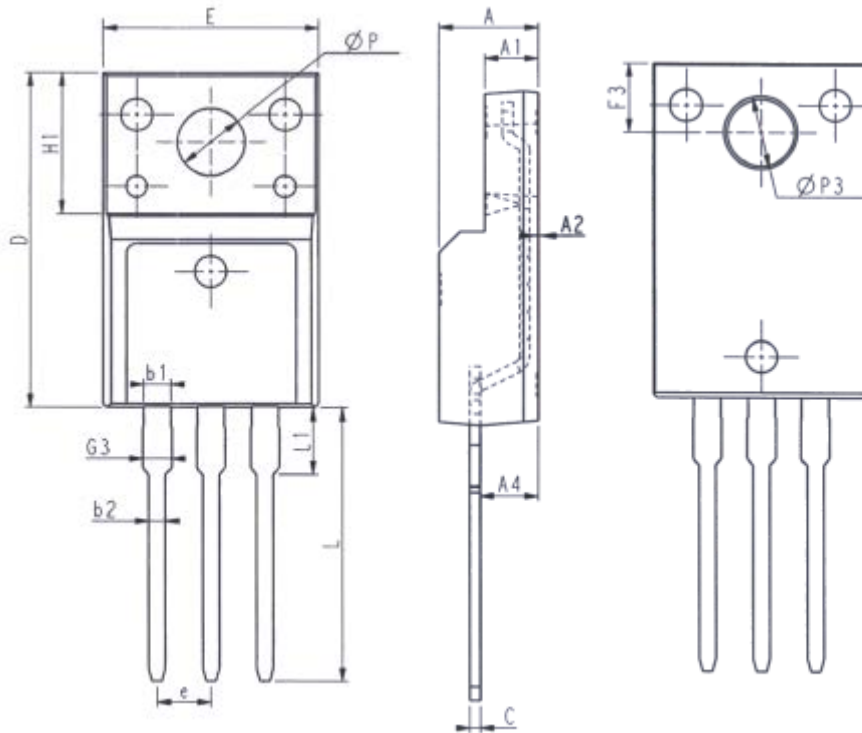

| Unit: mm |         |       | Unit: mm |       |       |
|----------|---------|-------|----------|-------|-------|
| Symbol   | Min.    | Max.  | Symbol   | Min.  | Max.  |
| E        | 9.96    | 10.36 | L        | 12.68 | 13.28 |
| A        | 4.50    | 4.90  | L1       | 2.93  | 3.13  |
| A1       | 2.34    | 2.74  | P        | 3.03  | 3.38  |
| A2       | 0.30    | 0.60  | P3       | 3.15  | 3.65  |
| A4       | 2.56    | 2.96  | F3       | 3.15  | 3.45  |
| c        | 0.40    | 0.65  | G3       | 1.25  | 1.55  |
| D        | 15.57   | 16.17 | b1       | 1.18  | 1.43  |
| H1       | 6.70REF |       | b2       | 0.70  | 0.95  |
| e        | 2.54BSC |       |          |       |       |



## Disclaimer

All product specifications and data are subject to change without notice.

For documents and material available from this datasheet, Wuxi Unigroup does not warrant or assume any legal liability or responsibility for the accuracy, completeness of any product or technology disclosed hereunder.

No license, express or implied, by estoppels or otherwise, to any intellectual property rights is granted by this document or by any conduct of Wuxi Unigroup.

The products shown herein are not designed for use in medical, life-saving, or life-sustaining applications. Customers using or selling Wuxi Unigroup products not expressly indicated for use in such applications do so entirely at their own risk and agree to fully indemnify Wuxi Unigroup for any damages arising or resulting from such use or sale.

Wuxi Unigroup disclaims any and all liability arising out of the use or application of any product described herein or of any information provided herein to the maximum extent permitted by law. The product specifications do not expand or otherwise modify Wuxi Unigroup's terms and conditions of purchase, including but not limited to the warranty expressed therein, which apply to these products.

Wuxi Unigroup Microelectronics CO., LTD. strives to supply high-quality high-reliability products. However, any and all semiconductor products fail with some probability. It is possible that these probabilistic failures could give rise to accidents or events that could endanger human lives that could give rise to smoke or fire, or that could cause damage to other property. When designing equipment, adopt safety measures so that these kinds of accidents or events cannot occur. Such measures include but are not limited to protective circuits and error prevention circuits for safe design, redundant design, and structural design.

In the event that any or all Wuxi Unigroup products (including technical data, services) described or contained herein are controlled under any of applicable local export control laws and regulations, such products must not be exported without obtaining the export license from the authorities concerned in accordance with the above law.

Information (including circuit diagrams and circuit parameters) herein is for example only. It is not guaranteed for volume production. Wuxi Unigroup believes information herein is accurate and reliable, but no guarantees are made or implied regarding its use or any infringements of intellectual property rights or other rights of third parties.



## X-ON Electronics

Largest Supplier of Electrical and Electronic Components

*Click to view similar products for [MOSFET](#) category:*

*Click to view products by [UNIGROUP](#) manufacturer:*

Other Similar products are found below :

[614233C](#) [648584F](#) [MCH3443-TL-E](#) [MCH6422-TL-E](#) [FDPF9N50NZ](#) [FW216A-TL-2W](#) [FW231A-TL-E](#) [APT5010JVR](#) [NTNS3A92PZT5G](#)  
[IRF100S201](#) [JANTX2N5237](#) [2SK2464-TL-E](#) [2SK3818-DL-E](#) [FCA20N60\\_F109](#) [FDZ595PZ](#) [STD6600NT4G](#) [FSS804-TL-E](#) [2SJ277-DL-E](#)  
[2SK1691-DL-E](#) [2SK2545\(Q,T\)](#) [D2294UK](#) [405094E](#) [423220D](#) [MCH6646-TL-E](#) [TPCC8103,L1Q\(CM](#) [367-8430-0972-503](#) [VN1206L](#)  
[424134F](#) [026935X](#) [051075F](#) [SBVS138LT1G](#) [614234A](#) [715780A](#) [NTNS3166NZT5G](#) [751625C](#) [873612G](#) [IRF7380TRHR](#)  
[IPS70R2K0CEAKMA1](#) [RJK60S3DPP-E0#T2](#) [RJK60S5DPK-M0#T0](#) [APT5010JVFR](#) [APT12031JFLL](#) [APT12040JVR](#) [DMN3404LQ-7](#)  
[NTE6400](#) [JANTX2N6796U](#) [JANTX2N6784U](#) [JANTXV2N5416U4](#) [SQM110N05-06L-GE3](#) [SIHF35N60E-GE3](#)