



FEATURES

- Wide operating voltage: 8V ~ 14V
- Output Current up to 20A
- Output voltage ripple: 20mV_{PP}
- High Efficiency 95%
- Overcurrent /shortcircuit protection
- Over-temperature protection
- Remote on/off control – negative or positive
- High reliability: designed to meet 5 million hour MTBF
- Output voltage remote sense compensation ("s" suffix)
- Minimal space on PCB:
 - 50.8 mm x 12.7 mm x 8.0 mm or
 - 2.0 in x 0.50 in x 0.31 in
- No derating to +60°C, natural convection
- UL/IEC/EN60950 compliant
- RoHS Compliant available

APPLICATIONS

- Workstations, servers
- Desktop computers
- DSP applications
- Distributed power architectures
- Telecommunications equipment
- Data communications equipment
- Wireless communications equipment

Options

- Output voltage remote sense
- Right Angle
- Remote Control Logic mode

Description

The **SuperTarzan™** MQ7260ASIP/IBA Series Power Modules are non-isolated dc-dc converters that operate over a wide input voltage range of 8Vdc to 14Vdc and provide a precisely (2%) regulated dc output with industry standard pin configuration. Such a module is suitable to application with 10V or 14V power supply bus. The modules have a maximum output current rating of 20A at typical full-load efficiency over 95%. Standard features include remote on/off with positive logic and output voltage adjustment, over-current protection, over-temperature protection. Option features include output voltage remote sense compensation.

***** **Typical Application Circuit** *****

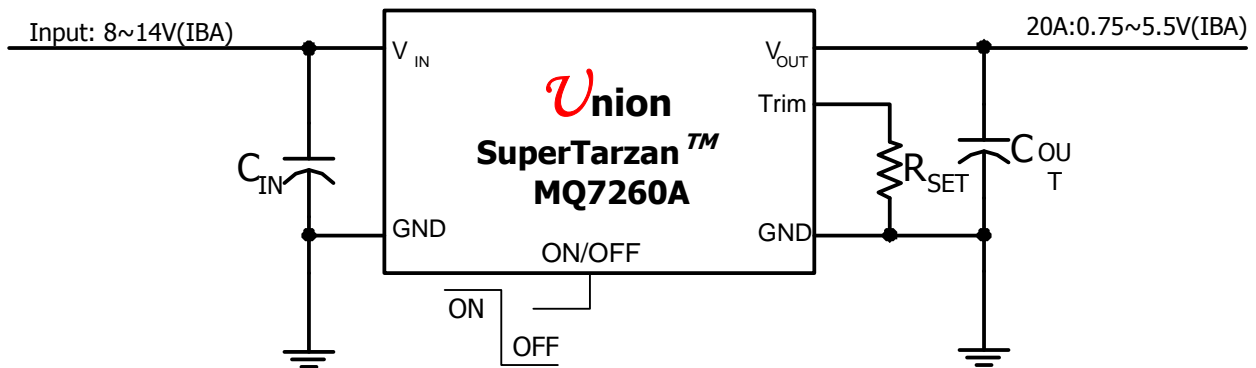

Performance Specifications (at TA=+25°C)

Model	Input V _{IN} Range (V)	Output				Efficiency (%)
		I _{OUT} (A)	Trim Range (V)	Regulation		
				Line (%)	Load (%)	
MQ7260ASIP/IBA	8~14	20	0.75V~5.5V	0.5	0.5	95

Mechanical Specifications

Dimensions are in mm (inches)
 Tolerances: x.x mm±0.5mm (x.xx in ±0.02 in);
 x.xx mm±0.25mm (x.xxx in ±0.01 in)

PIN	DESCRIPTION
1	V _{OUT}
2	V _{OUT}
3	SENSE ("S" suffix)
4	V _{OUT}
5	GND
6	GND
7	V _{IN}
8	V _{IN}
9	TRIM
10	ENABLE

Ordering Information

MQ7260ASIP2abcdSRNG-B

Union Microsystems
 Power module P/N
 SIP/SMT Package

Input Voltage Range:
 1:3.0~5.5V
 2:8~14V

Output Voltage:
 9999: for adjustable version
 abcd: a*10+b*1+c*0.1+d*0.01

B: Backside Pin
 Green Product (RoHS Compliant)
 N: Negative Logic
 P: Positive Logic
 R: Right Angle Pin
 X: Normal Pin
 S: Remote Sense
 X: Non-Remote Sense

For examples:

MQ7260ASIP29999SXNG means MQ7260A in SIP Pin-out, input voltage 8~14V, output voltage 0.75~5.5V, and with remote sense pin equipped, normal pin direction, negative logic control and green product.

MQ7260ASIP20150XRPG means MQ7260A in SIP Pin-out, input voltage 8~14V, output voltage 1.5V, and without remote sense pin equipped, right angle pin direction, positive logic control and green product.

Absolute Maximum Ratings

Note: These are stress ratings. Exposure of devices to any of these conditions may adversely affect long-term reliability. Proper operation under conditions other than those listed in the Performance Specifications Table is not implied.

Parameter	Symbol	Min	Max	Unit
Input Voltage	V_{IN}	-0.3	16	V
Storage Temperature	T_{STG}	-40	125	°C

MQ7260ASIP/IBA Electrical Specifications: ($T_A=+25^\circ\text{C}$)

Parameter	Condition	Symbol	Min	Typ	Max	Unit
Input Voltage Range		V_{IN}	8		14	V
Output Current		I_o	0		20	A
Output Voltage Set point	100% load	ΔV_o	-2		+2	%
Temperature Regulation	$T_A = T_{A,MIN}$ TO $T_{A,MAX}$	-		0.4		% $V_{O,SET}$
Remote Sense Range					0.5	V
Line Regulation	See each output's corresponding character figure					
Load Regulation						
Output Ripple and Noise Voltage						
Transient Response						

General Specifications

Parameter	Condition	Symbol	Min	Typ	Max	Unit
Maximum Capacitive Load	10A resistive load + Aluminum capacitor			6600		μF
	10A resistive load +Sanyo POSCAP			2000		
Overcurrent Protection			24		40	A
Output short-circuit current (average)	All				3	A
Under Voltage Lockout Trip Level	Rising and falling V_{IN} , 3% hysteresis		7.8	8	8.2	V
Positive Logic						
Input High Voltage (Module ON)		V_{IH}			$V_{IN,MAX}$	V
Input Low Voltage (Module OFF)		V_{IL}	-0.2		0.3	V
Negative Logic						
Input High Voltage (Module OFF)		V_{IH}	2		$V_{IN,MAX}$	V
Input Low Voltage (Module ON)		V_{IL}	-0.2		0.3	V
Start-up Time	10A resistive load, no external output capacitors		3	4	5	ms
Switching Frequency		F_o		300		kHz
Operating Temperature	Natural convection		-40		85	°C
Vibration	3 Axes, 5 Min Each	10~55Hz, 0.35mm, 5g				
	3 Axes, 6 Times Each	Peak Deviation 300g, Settling Time 6mS				
MTBF			5,000,000			Hour

Test Configurations

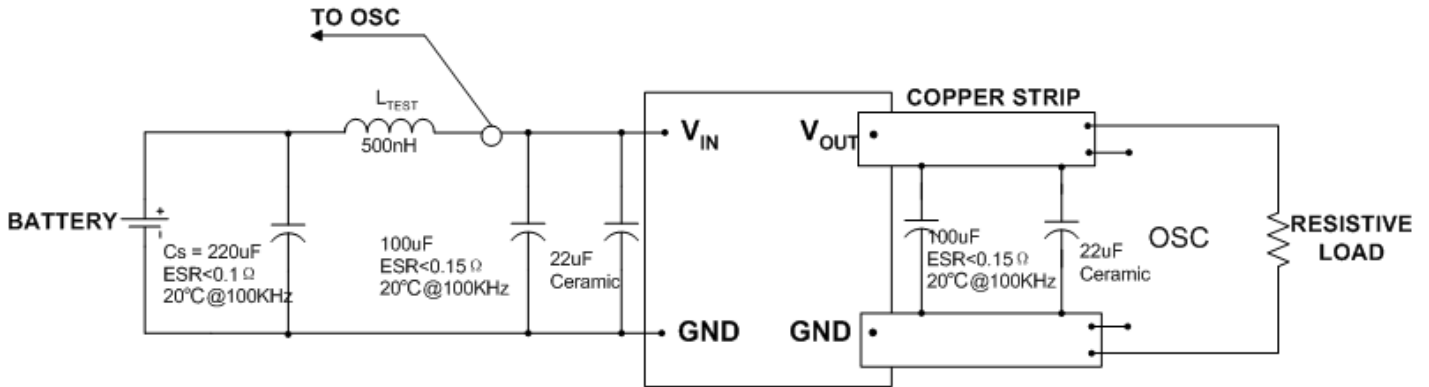

Test setup for input noise, output noise and ripple

Note:

Output noise is measured with 0.1µ F ceramic capacitor connected at the output. OSC measurement should be made using a BNC socket. Position the load between 50mm and 75mm (2in. and 3in) from the tested module.

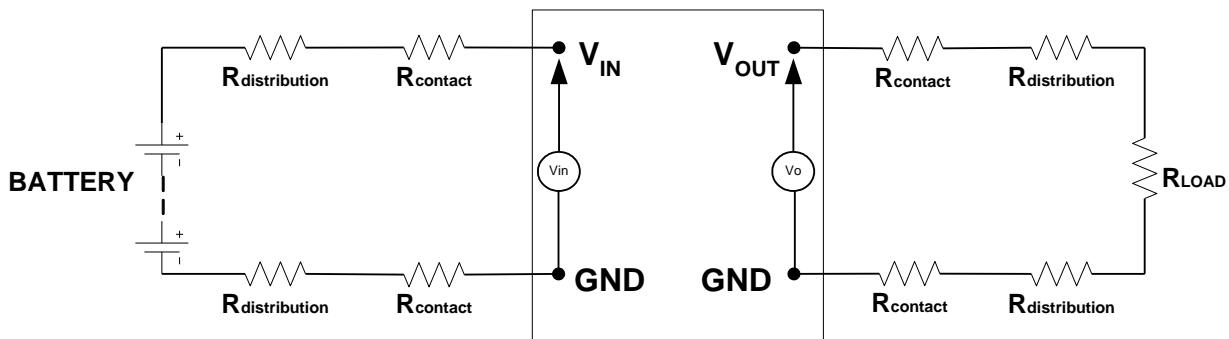

Test setup for efficiency

Note:

All voltage measurements must be taken at the module’s terminals, as shown above. If sockets are needed, Kelvin connections are required at the module terminals to avoid measurement errors due to socket contact resistance.

Technical Notes

Input Voltage Range

The MQ7260ASIP/IBA Series can be used in a wide variety of applications, esp. most of unregulated 12V intermediate power supply bus system. Its wide input voltage ranges can tolerate worst voltage drop from cheap isolated Brick-type Bus-converter, so it reduces total system cost on power supply.

Return Current Paths

The MQ7260ASIP/IBA Series are non-isolated DC/DC converters. Their two Common pins (pins 5 and 6) are connected to each other internally. To the extent possible with the intent of minimizing ground loops, input return current should be directed through pin 6 (also referred to as---Input or Input Return), and output return current should be directed through pin 5 (also referred to as---Output or Output Return) as short as possible.

I/O Filtering

All the specifications of the MQ7260ASIP/IBA Series are tested with specified output capacitors. However, certain input capacitors are necessary to improve the power modules’ operating conditions and to reduce the ac impedance. For example, under some conditions, the power modules can’t normally start up when fully loaded due to the high ac-impedance input source. External

input capacitors serve primarily as energy-storage devices. They should be added close to the input pins of the MQ7260ASIP/IBA and selected for bulk capacitance (at appropriate frequencies), low ESR, and high rms-ripple-current ratings. All external capacitors should have appropriate voltage ratings. To reduce the amount of ripple current fed back to the input supply (input reflected-ripple current), an external L-C filter can be added with the inductance as close to the power module as possible.

MQ7260ASIP/IBA's output ripple and transient response can be improved with the increasing output capacitance. When using output capacitors, take care that the total output capacitance does not exceed MQ7260ASIP/IBA's Maximum Capacitive Load to avoid issuing the module's over-current protection mechanism in the start-up procedure.

When an external L-C filter is added to reduce ripple on load, for best results, the filter components should be mounted close to the load circuit rather than the power module.

When testing the relationship between external capacitors and output voltage noise, the oscilloscope's probe should be applied to the module's end directly with scope probe ground less than 10mm in length.

Input Fusing

The MQ7260ASIP/IBA Series is not internally fused. Certain applications and/or safety agencies may require the installation of fuses at the inputs of power conversion components. The selection of the fuses should conform to the following:

1. The fuse value should be fast-blow 16A fuses.
2. Both input traces must be capable of carrying a current of 1.5 times the value of the fuse without opening.

Safety Considerations

MQ7260ASIP/IBA's are non-isolated DC/DC converters. In general, all DC-DC's must be installed in compliance with relevant safety-agency specifications (usually UL/IEC/EN60950). In particular, for a non-isolated converter's output voltage to meet SELV (safety extra low voltage) requirements, its input must be SELV compliant. If the output needs to be ELV (extra low voltage), the input must be ELV.

Remote Sense

MQ7260ASIP/IBA Power Modules with suffix "S" offer a positive output sense function on pin SENSE. The sense function enables point-of-use regulation for overcoming moderate IR drops in conductors and/or cabling. The sense line carries very little current and consequently requires a minimal cross-sectional-area conductor. As such, it is not a low-impedance point and must be treated with care in layout and cabling. Sense lines should be run adjacent to signals (preferably ground). If the remote sense is not needed the sense pin should be left open or connected to V_{OUT} directly.

Use of trim and sense functions can cause the output voltage to increase, thereby increasing output power beyond the MQ7260ASIP/IBA's specified rating. Therefore:

$$V_{OUT} \text{ (at pins)} \times I_{OUT} \leq P \text{ (rated output power)}$$

ON/OFF Control

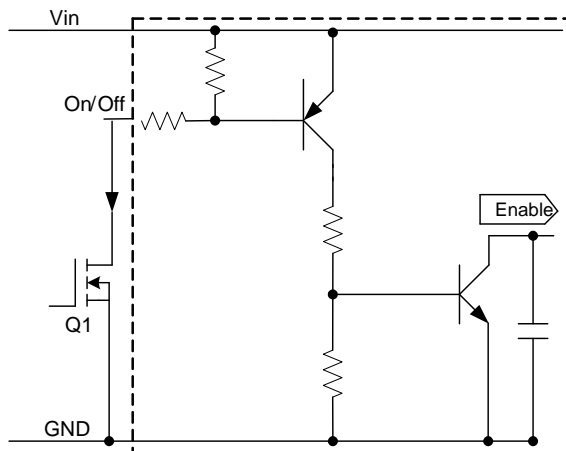

Fig1a. Circuit configuration for using Positive logic On/OFF

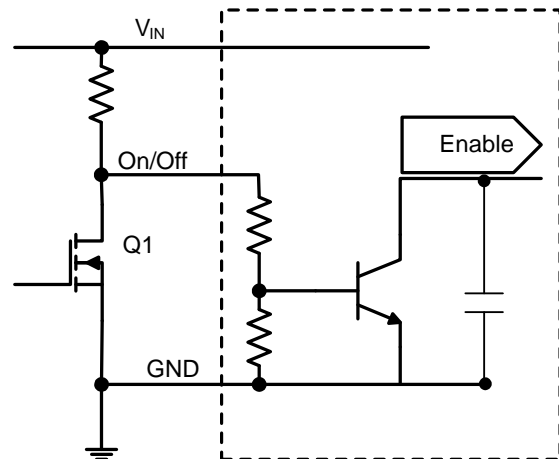

Fig1b. Circuit configuration for using negative logic On/OFF

For positive logic modules, the circuit configuration for using On/Off pin is shown in Fig1a. The On/Off pin is an open collector/drain logic input signal ($V_{on/Off}$) that is referenced to ground. During a logic-high (On/Off pin is pulled high internal to the module) when the Q1 is in the Off state, the power module is ON. Applying a logic-low when the transistor Q1 is turned-On, the power module is OFF.

For negative logic On/Off devices, the circuit configuration is shown in Fig1b. The On/Off pin is pulled high with an external pull-up resistor. When transistor Q1 is in Off state, logic High is applied to the On/Off pin and the power is Off. The minimum On/off

voltage for logic High on the On/Off pin is 2.5Vdc. To turn the module ON, logic low is applied to the On/Off pin by turning on Q1
The regulator will run in normal operation when the ON/OFF pin is left open.

Output Overvoltage Protection

MQ7260ASIP/IBA Series products do not incorporate output over voltage protection. If the operating circuit requires protection against abnormal output voltage, voltage-limiting circuitry must be provided external to the power module.

Output Overcurrent Protection (OCP)

MQ7260ASIP/IBA incorporates overcurrent and short circuit protection. If the load current exceeds the overcurrent protection setpoint, the MQ7260ASIP/IBA's internal overcurrent-protection circuitry immediately turns off the module, which then goes into Hiccup mode. The unit operates normally once the output current is brought back into its specified range. The typical average output current during hiccup is less than 3A.

Caution: *Be careful never to operate MQ7260ASIP/IBA in a "heavy overload" condition that is between the rated output current and the overcurrent protection setpoint. This can cause permanent damage to the components.*

Overtemperature Protection (OTP)

To ensure MQ7260ASIP/IBA's reliability and avoid damaging its internal components, MQ7260ASIP/IBA incorporates over-temperature protection circuit. When the temperature of the PCB is above 125°C, the overtemperature protection circuit will be enabled and the module will stop working. When the temperature of the temperature-testing component is below about 80°C, the overtemperature protection circuit will release and the module will automatically recover from shutdown. To avoid permanently damaging components, the surface temperature of MQ7260ASIP/IBA's power components, esp. of the MOSFET (T_{REF} in Fig2) should be ensured below 125°C.

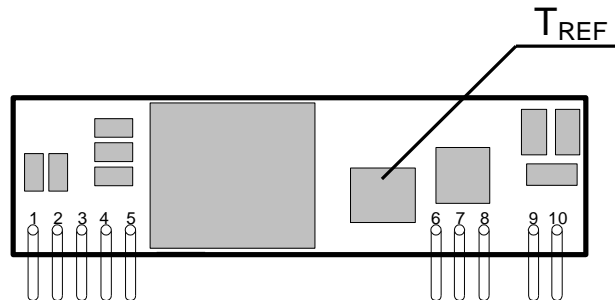

Fig2, Temperature Reference Point

Note: *The over temperature protection may be issued when MQ7260ASIP/IBA operates in a "heavy overload" condition for a long time. Thus, the airflow should be improved.*

Output Voltage Trimming

MQ7260ASIP/IBA's output voltage can be trimmed in certain ranges. See Figure 3 for the 2 programming methods. See Performance Specifications for allowable trim ranges in detail. Also customized products are offered.

Trim with external resistor (Fig3a), the equation as below:

$$R_{TRIM} = \frac{10500}{V_o - 0.7525} - 1000$$

Resistor values are in Ω; V_o is desired output voltage.

For examples, to trim output to 1.5V, then

$$R_{TRIM} = \frac{10500}{1.5 - 0.7525} - 1000 = 13046$$

So, R_{TRIM} = 13.046kΩ

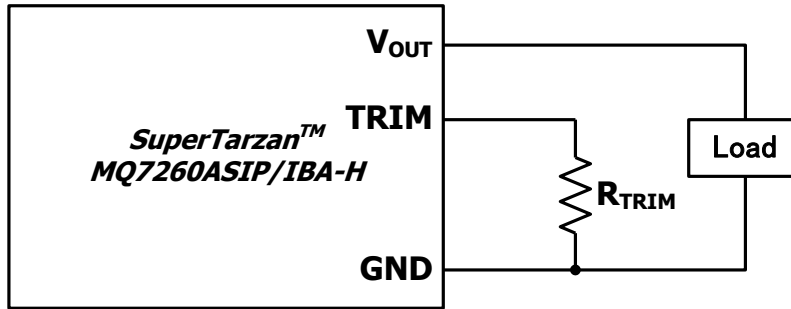

Fig3. Circuit configuration for programming output voltage using external resistor

For most common voltages, the required Trim resistors as Table 1.

Table 1, the required trim resistors R_{TRIM} for most common voltages

Desired Voltages (V)	R_{TRIM} (k Ω)
0.7525	Open
1.2	22.46
1.5	13.05
1.8	9.024
2.5	5.009
3.3	3.122
5.0	1.472

Typical Characteristics – output adjusted to 1V

General conditions:

Input filter 22µF Ceramic + 47µF TAN (150mΩ ESR), Output filter 22µF Ceramic + 100µF TAN (150mΩ ESR)

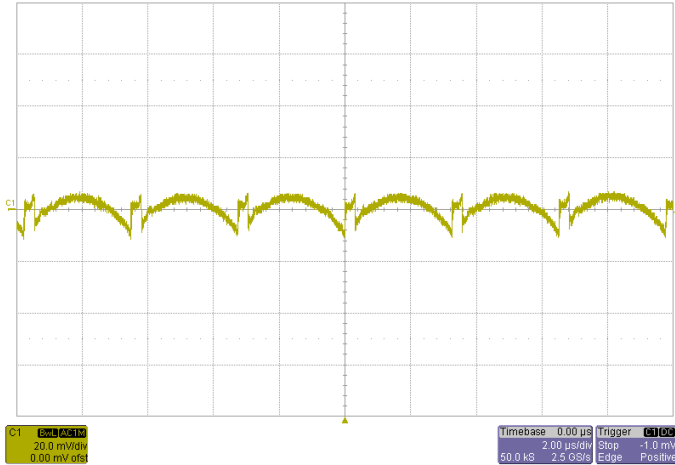

Noise VIN=12V, IO=16A, 5~20MHz Bandwidth

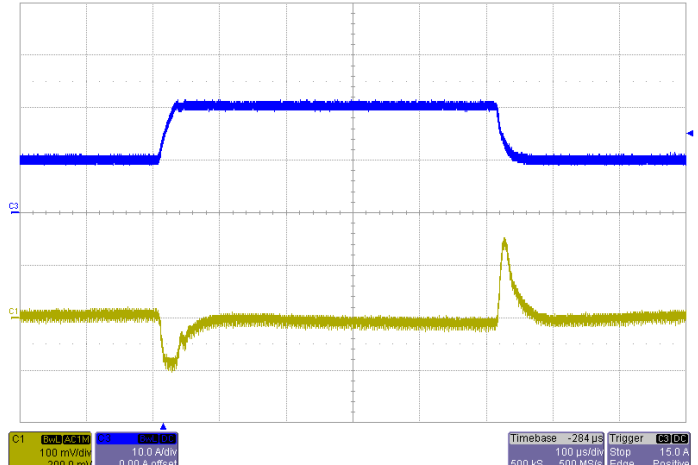

Transient Response VIN=12V, Step from 8A~16A~8A

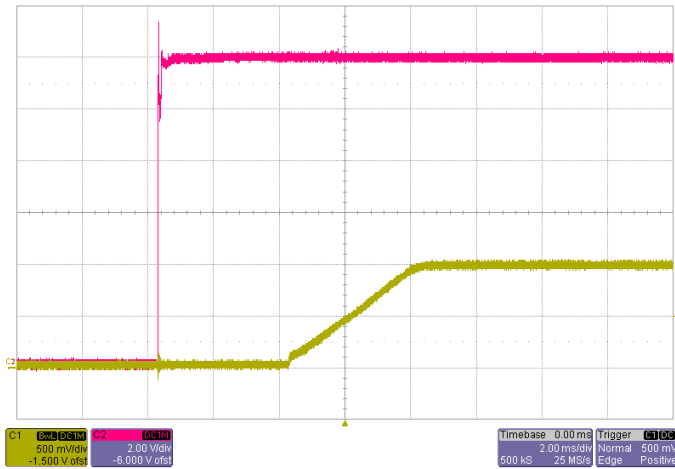

Start-up VIN=12V, IO=16A

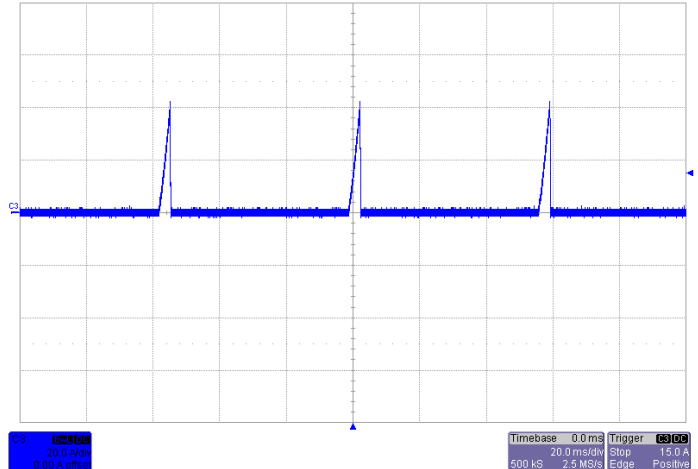

Short-Circuit Output VIN=12V

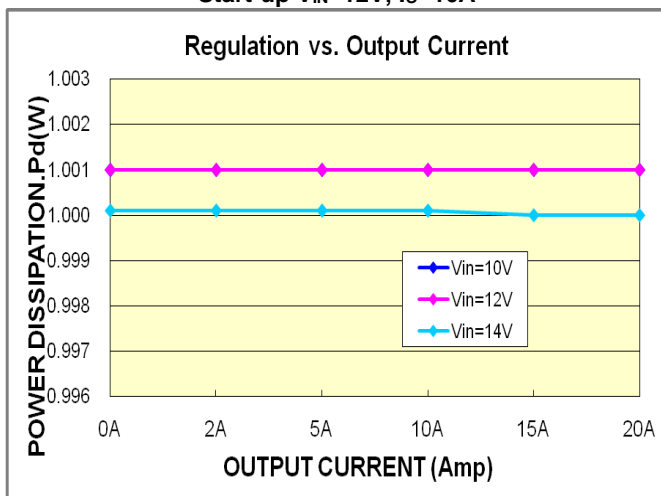

Regulation
Output voltage vs. Load Current

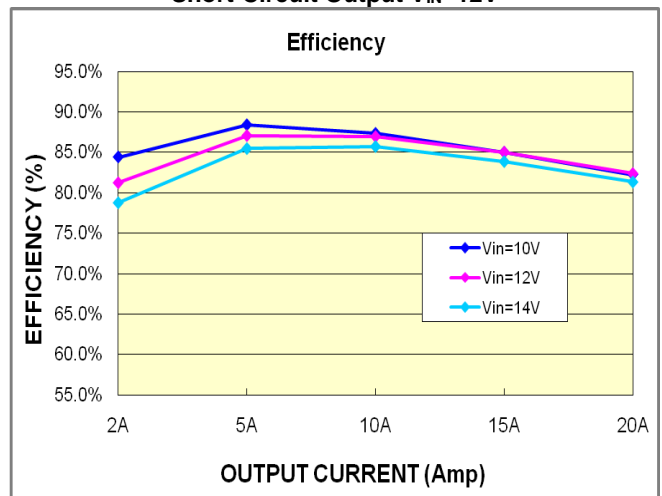

Efficiency

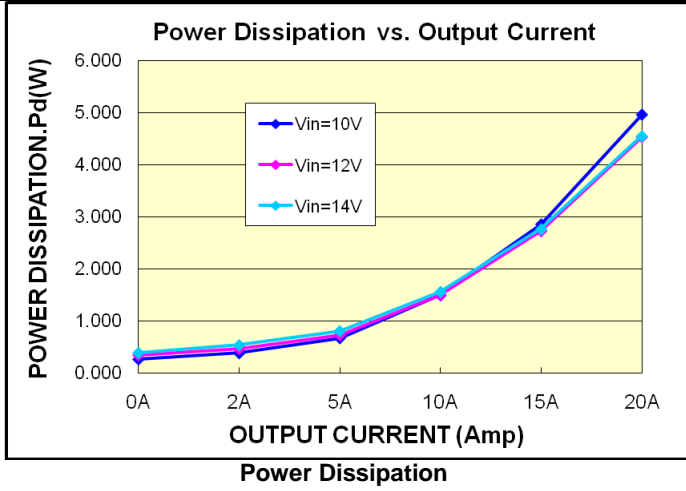

TBD

Output Current Derating (Load Current vs. Ambient Temperature (T_{REF} , See Page 6)), $V_{IN}=12V$

Typical Characteristics – output adjusted to 1.2V

General conditions:

Input filter 22µF Ceramic + 47µF TAN (150mΩ ESR), Output filter 22µF Ceramic + 100µF TAN (150mΩ ESR)

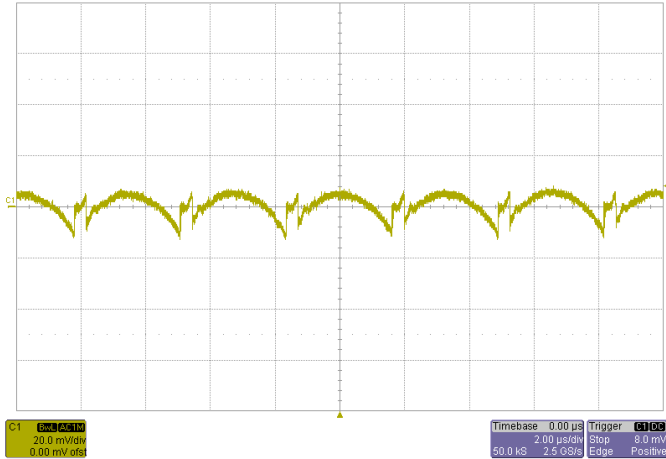

Noise VIN=12V, IO=16A, 5~20MHz Bandwidth

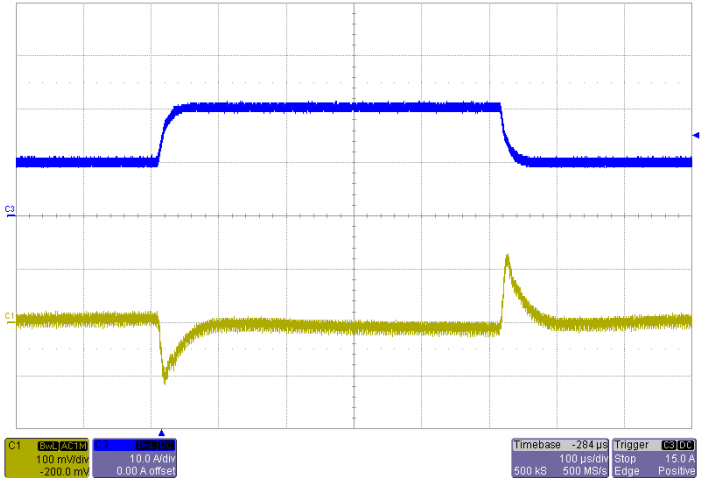

Transient Response VIN=12V, Step from 8A~16A~8A

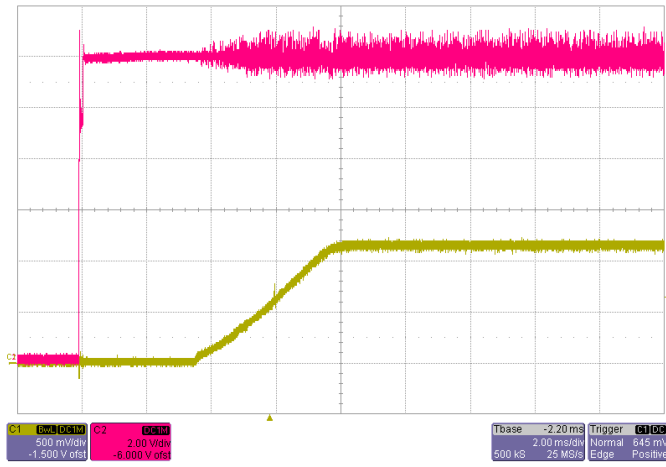

Start-up VIN=12V, IO=16A

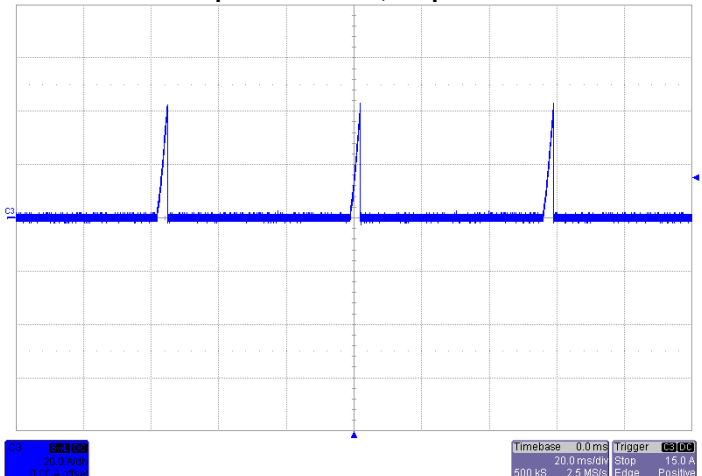

Short-Circuit Output VIN=12V

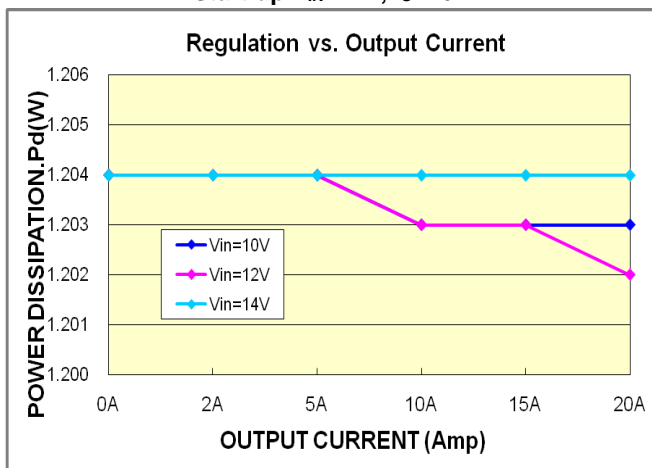

Regulation Output voltage vs. Load Current

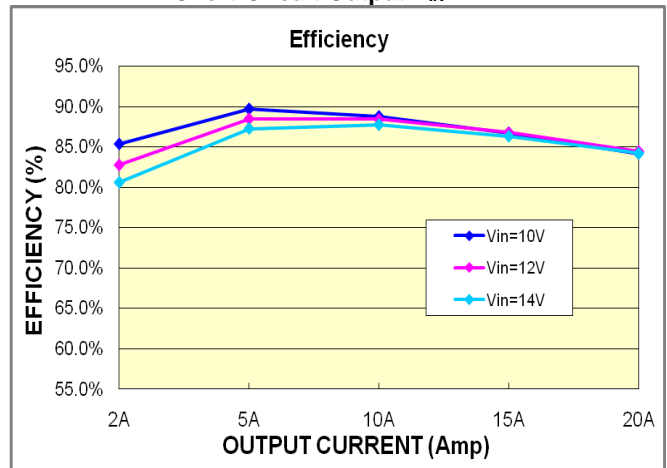

Efficiency

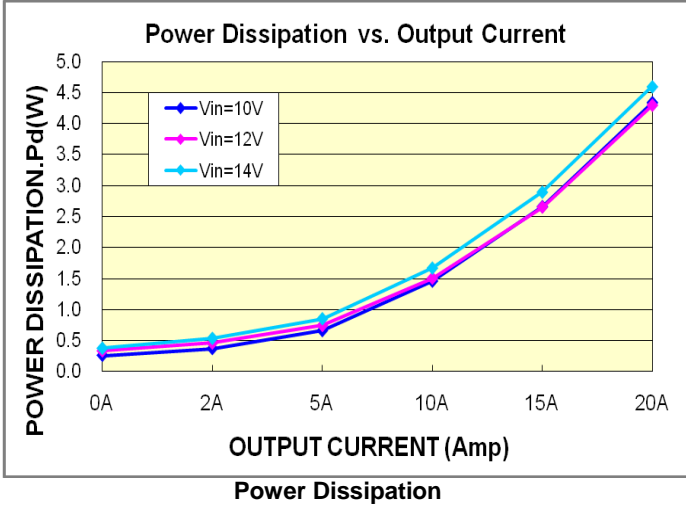

TBD

Output Current Derating (Load Current vs. Ambient Temperature (T_{REF} , See Page 6)), $V_{IN}=12V$

Typical Characteristics – output adjusted to 1.5V

General conditions:

Input filter 22µF Ceramic + 47µF TAN (150mΩ ESR), Output filter 22µF Ceramic + 100µF TAN (150mΩ ESR)

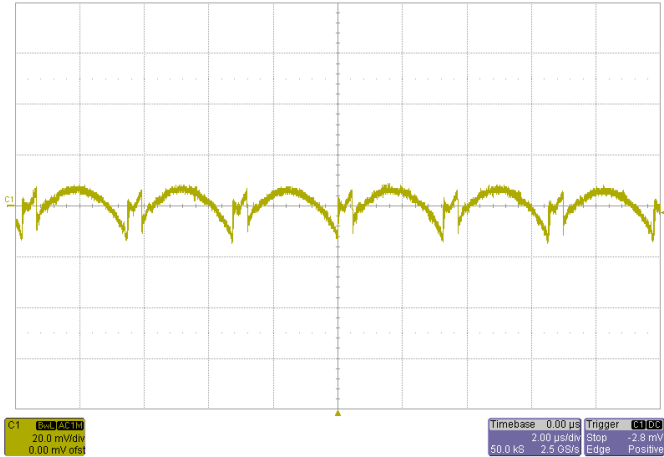

Noise VIN=12V, IO=16A, 5~20MHz Bandwidth

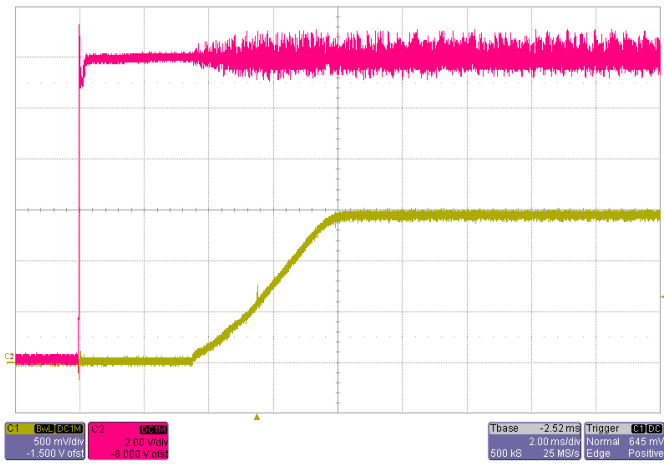

Start-up VIN=12V, IO=16A

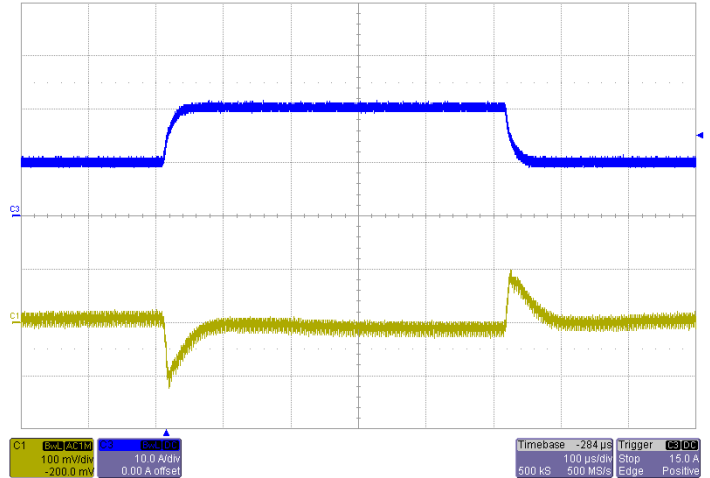

Transient Response VIN=12V, Step from 8A~16A~8A

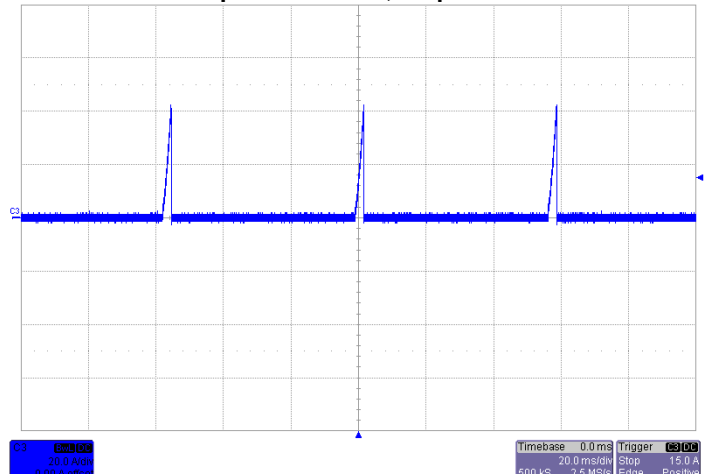

Short-Circuit Output VIN=12V

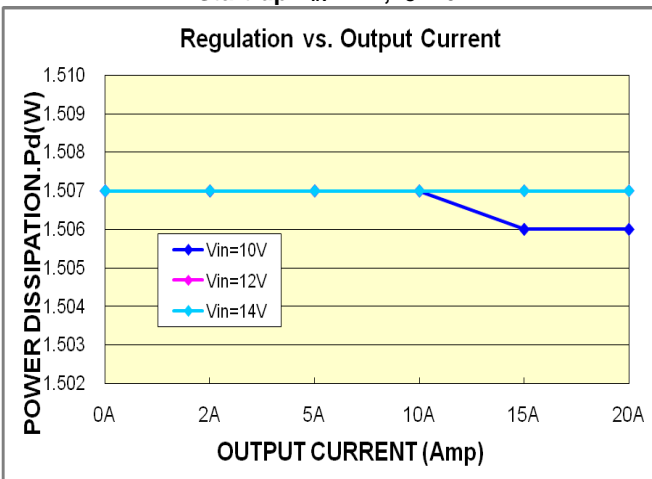

Regulation
Output voltage vs. Load Current

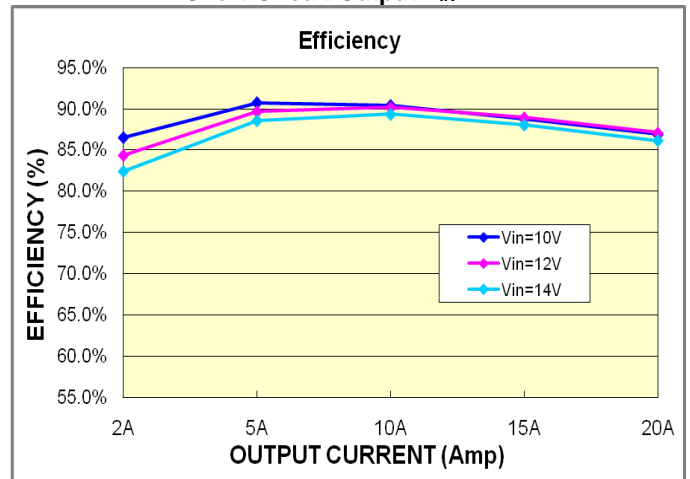

Efficiency

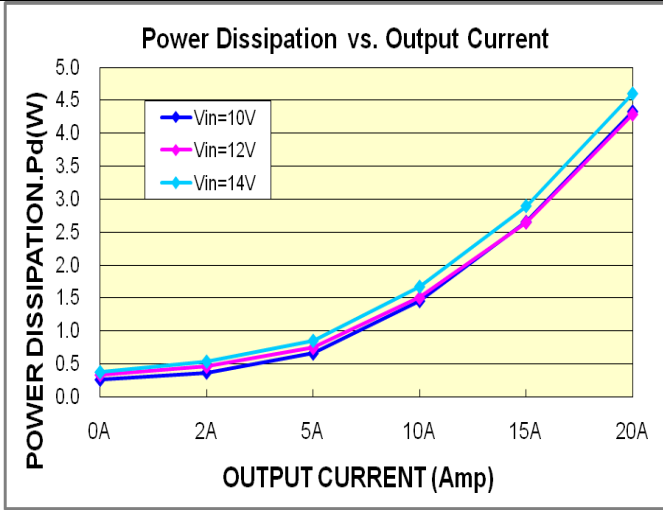

TBD

Output Current Derating (Load Current vs. Ambient Temperature (T_{REF} , See Page 6)), $V_{IN}=12V$

Typical Characteristics – output adjusted to 1.8V

General conditions:

Input filter 22µF Ceramic + 47µF TAN (150mΩ ESR), Output filter 22µF Ceramic + 100µF TAN (150mΩ ESR)

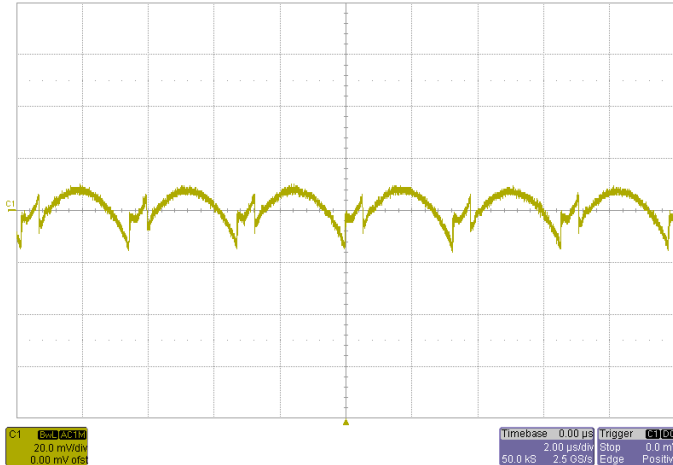

Noise VIN=12V, IO=16A, 5~20MHz Bandwidth

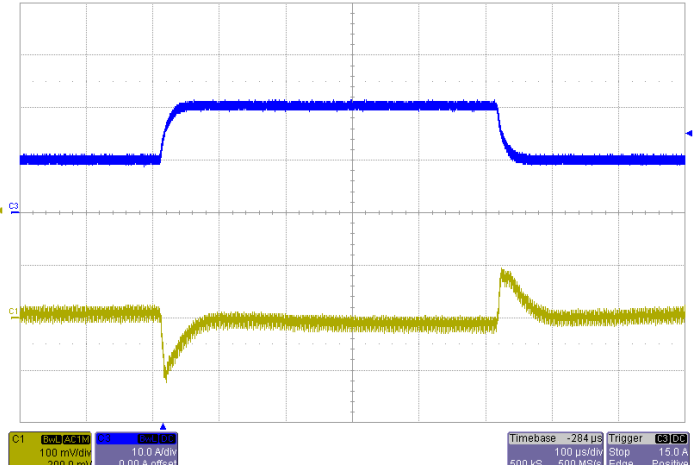

Transient Response VIN=12V, Step from 8A~16A~8A

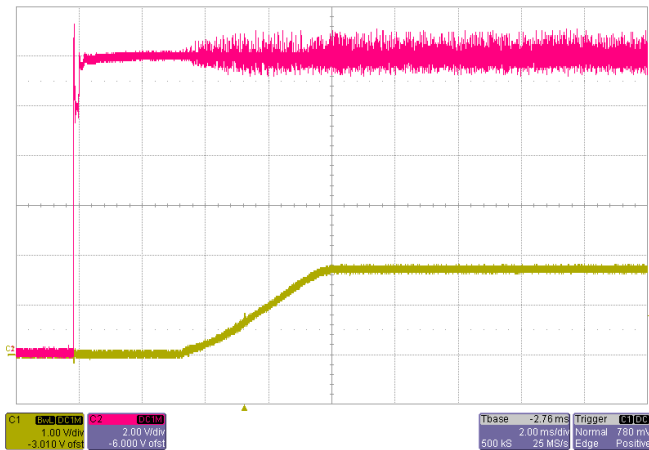

Start-up VIN=12V, IO=16A

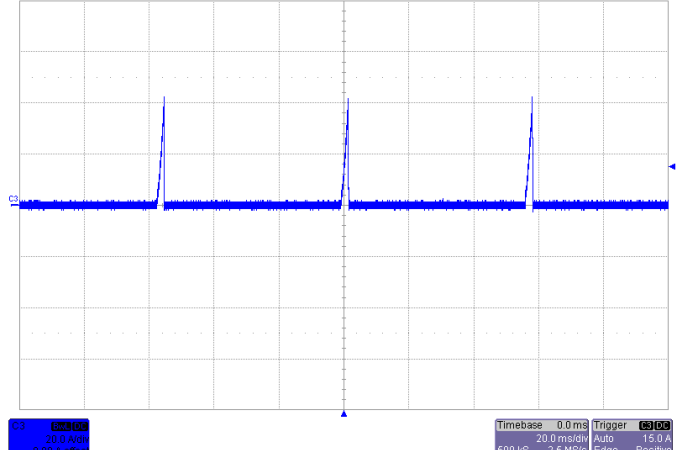

Short-Circuit Output VIN=12V

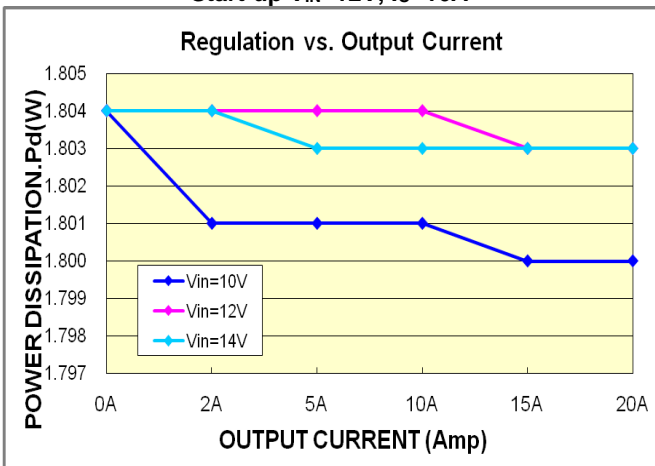

Regulation
Output voltage vs. Load Current

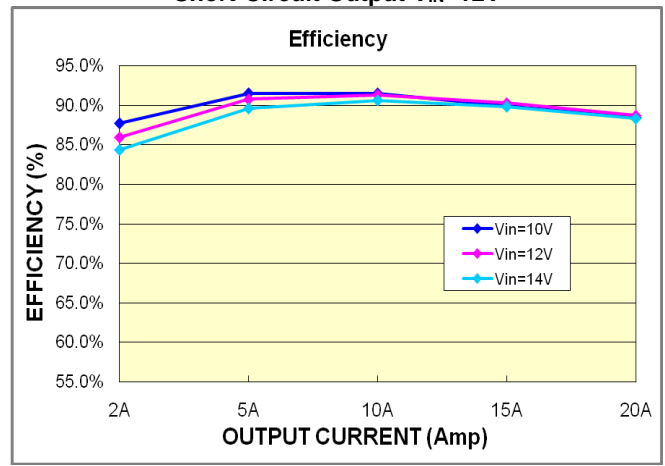

Efficiency

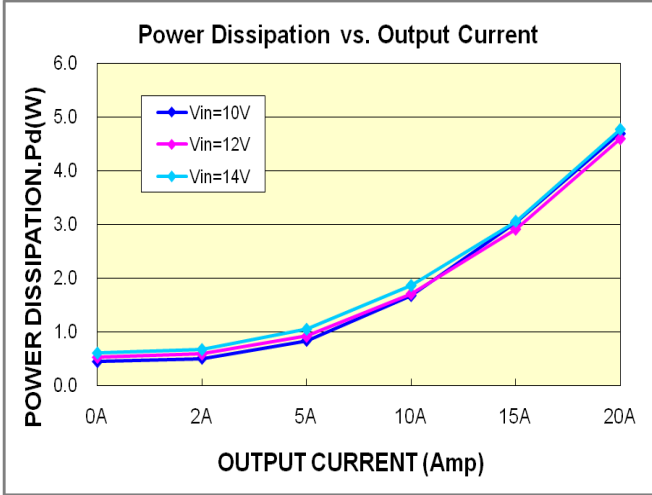

Power Dissipation

Output Current Derating (Load Current vs. Ambient Temperature (T_{REF} , See Page 6)), $V_{IN}=12V$

Typical Characteristics – output adjusted to 2.5V

General conditions:

Input filter 22µF Ceramic + 47µF TAN (150mΩ ESR), Output filter 22µF Ceramic + 100µF TAN (150mΩ ESR)

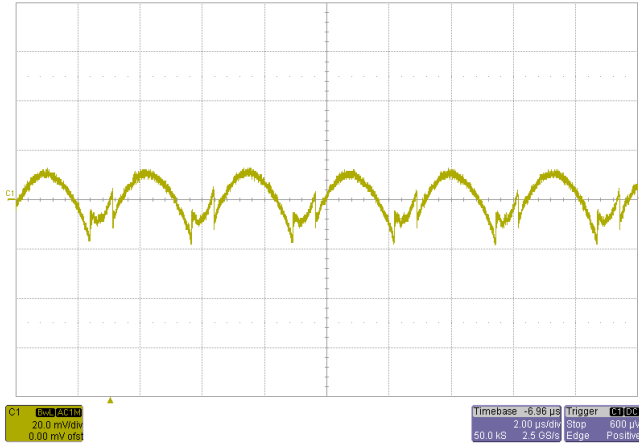

Noise VIN=12V, IO=16A, 5~20MHz Bandwidth

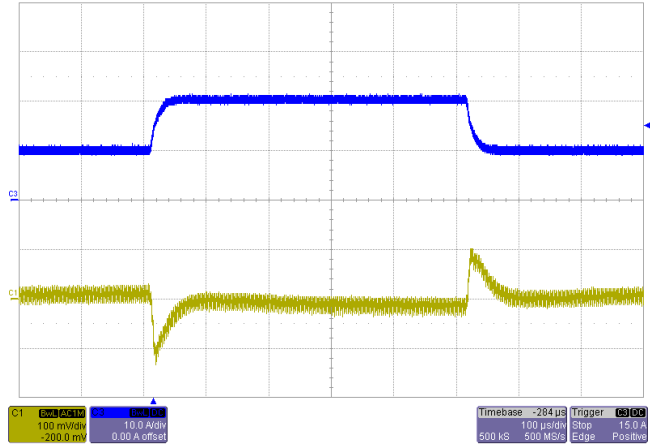

Transient Response VIN=12V, Step from 8A~16A~8A

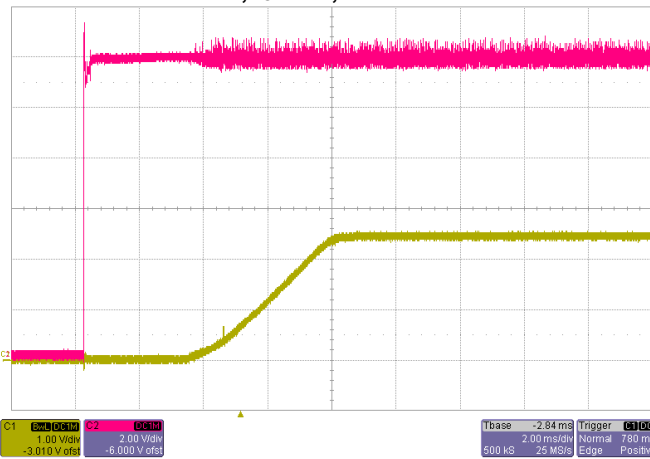

Start-up VIN=12V, IO=16A

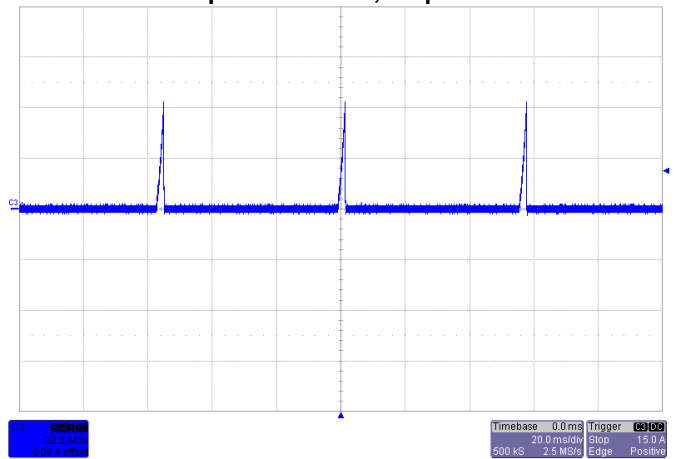

Short-Circuit Output VIN=12V

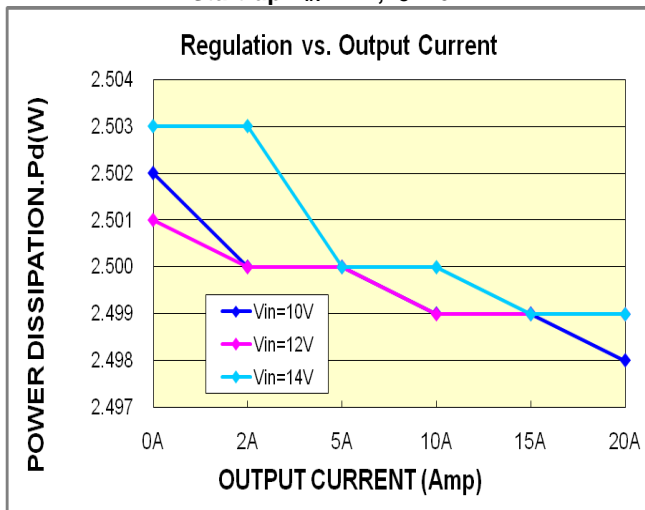

Regulation
Output voltage vs. Load Current

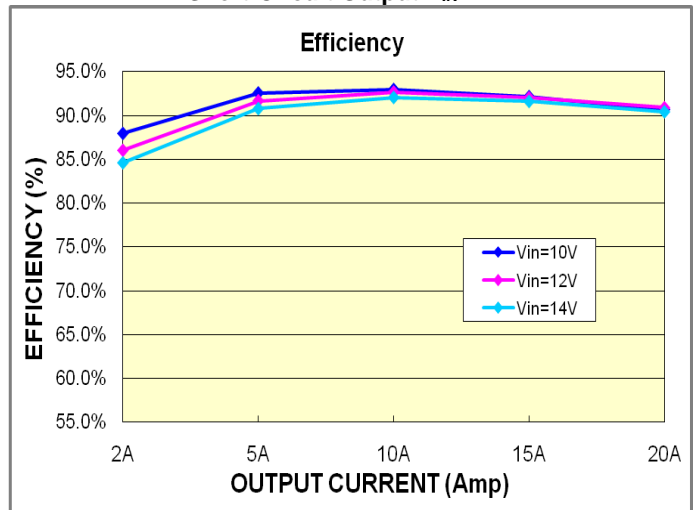

Efficiency

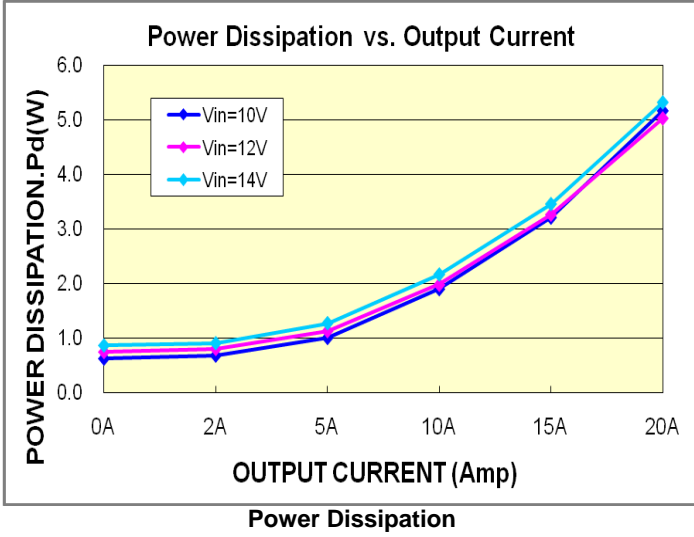

Output Current Derating (Load Current vs. Ambient Temperature (T_{REF} , See Page 6)), $V_{IN}=12V$

Typical Characteristics – output adjusted to 3.3V

General conditions:

Input filter 22µF Ceramic + 47µF TAN (150mΩ ESR), Output filter 22µF Ceramic + 100µF TAN (150mΩ ESR)

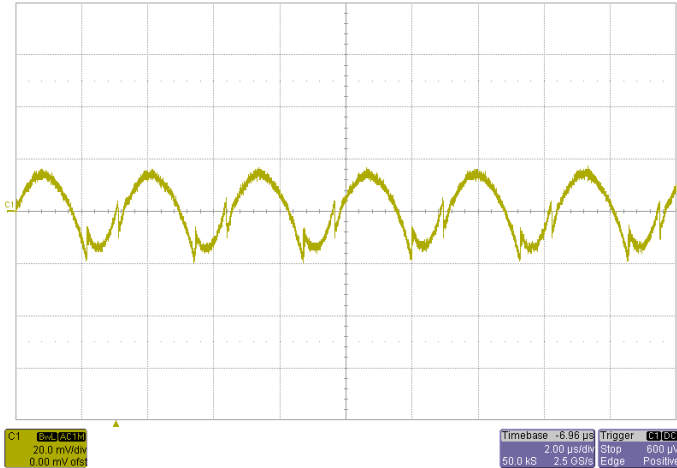

Noise VIN=12V, IO=16A, 5~20MHz Bandwidth

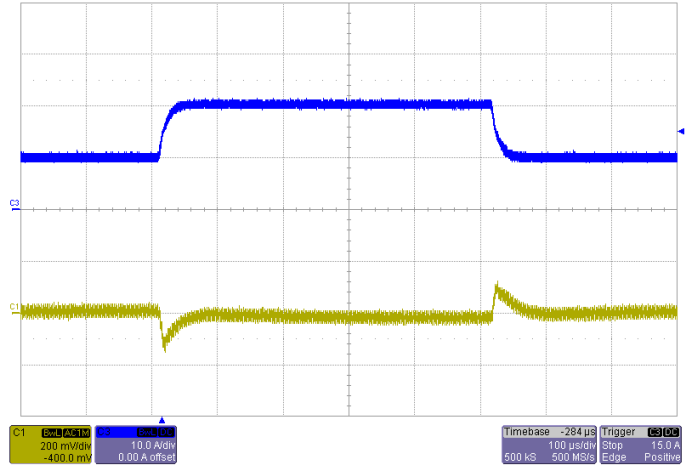

Transient Response VIN=12V, Step from 8A~16A~8A

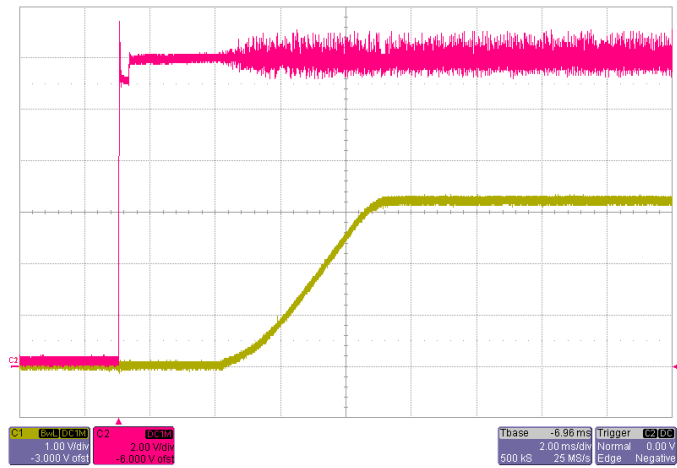

Start-up VIN=12V, IO=16A

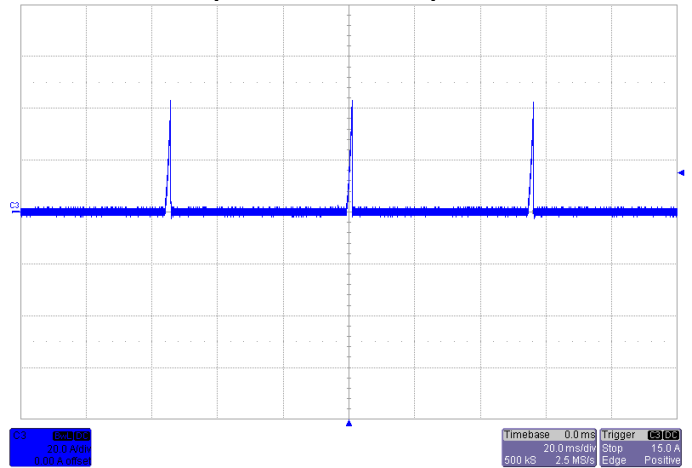

Short-Circuit Output VIN=12V

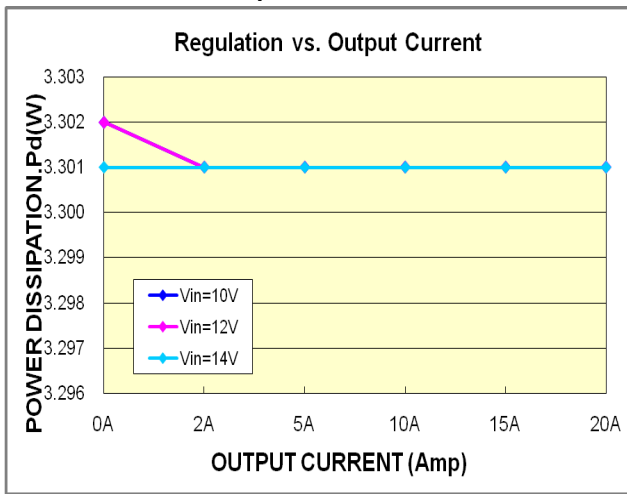

Regulation
Output voltage vs. Load Current

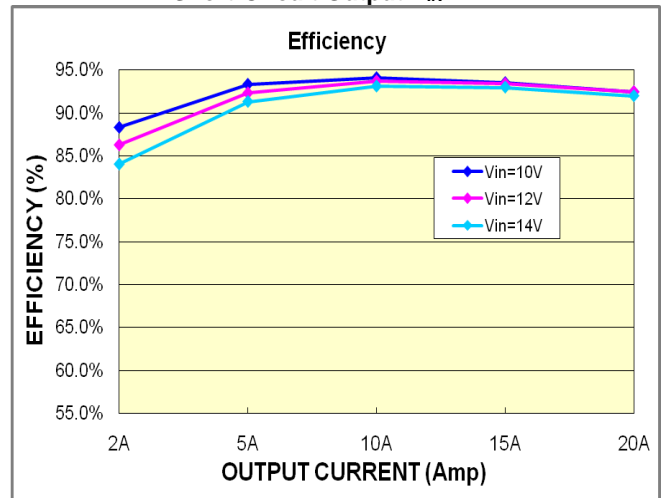

Efficiency

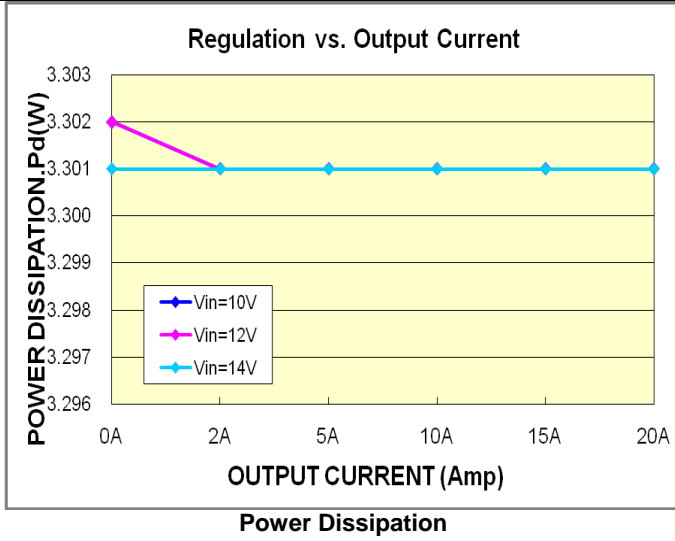

Output Current Derating (Load Current vs. Ambient Temperature (T_{REF} , See Page 6)), $V_{IN}=12V$

Typical Characteristics – output adjusted to 5.0V

General conditions:

Input filter 22µF Ceramic + 47µF TAN (150mΩ ESR), Output filter 22µF Ceramic + 100µF TAN (150mΩ ESR)

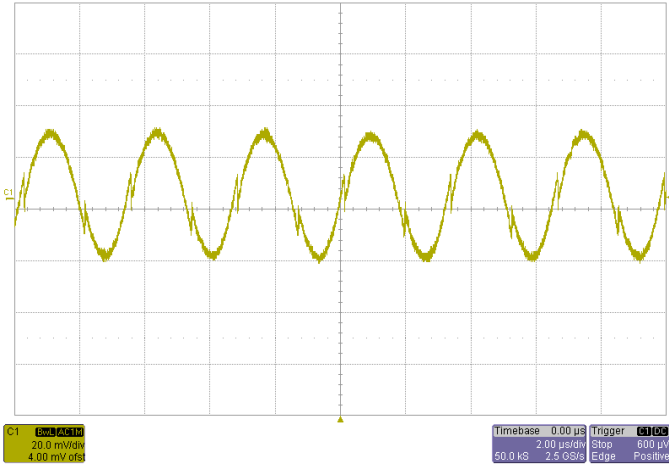

Noise VIN=12V, IO=16A, 5~20MHz Bandwidth

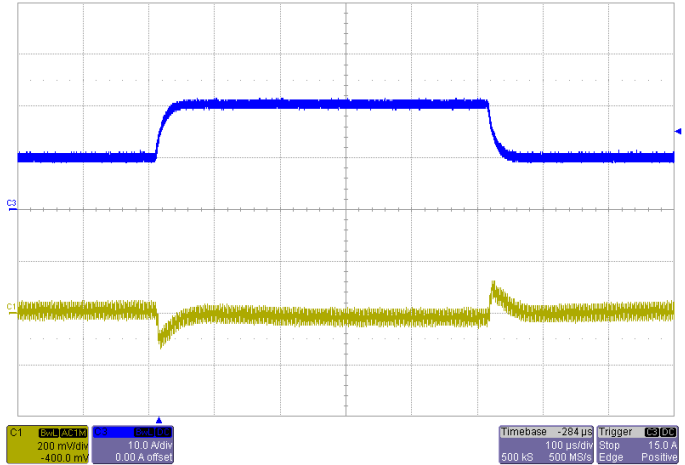

Transient Response VIN=12V, Step from 8A~16A~8A

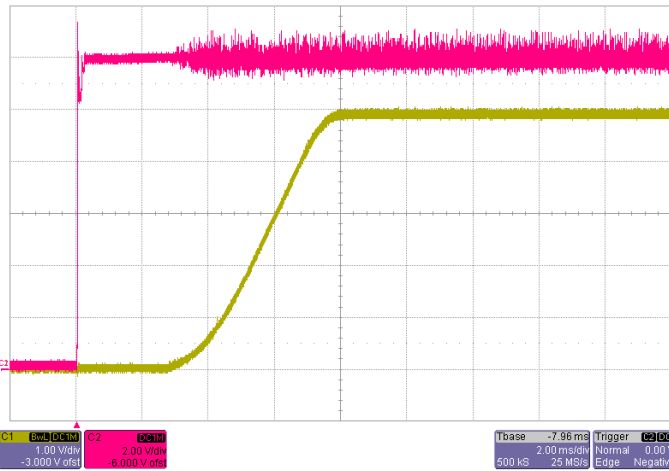

Start-up VIN=12V, IO=16A

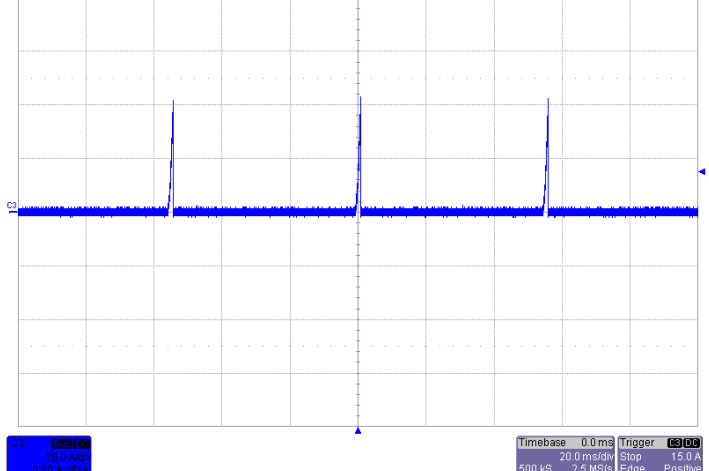

Short-Circuit Output VIN=12V

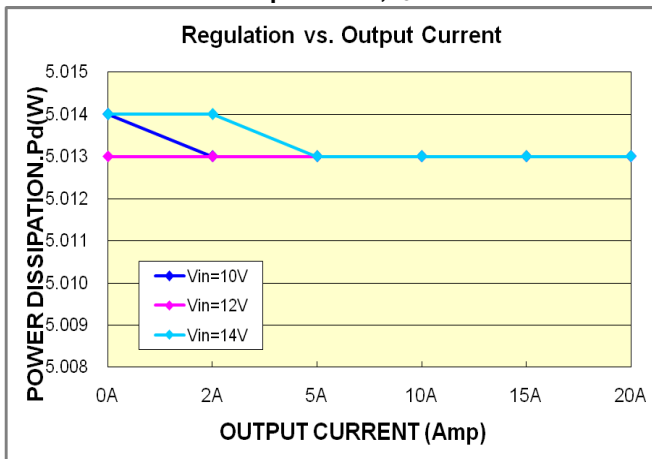

Regulation
Output voltage vs. Load Current

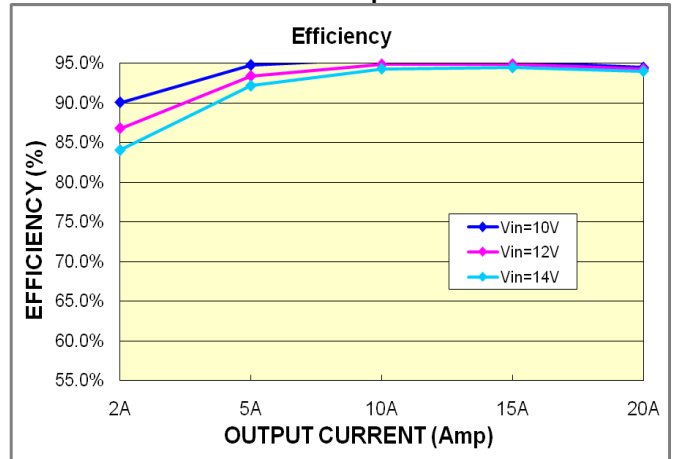

Efficiency

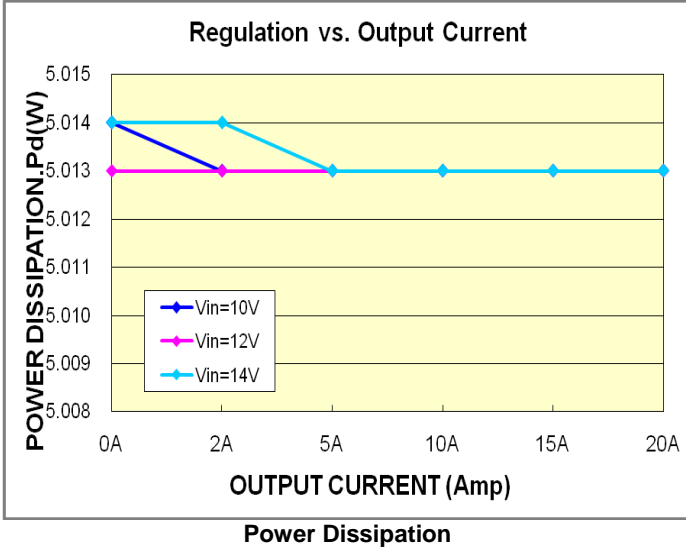

Output Current Derating (Load Current vs. Ambient Temperature (T_{REF}, See Page 6)), V_{IN}=12V

Recommended Hole Pattern

Dimensions are in millimeters (inches)
Tolerances: x.x mm±0.5mm (x.xx in ±0.02 in);
x.xx mm±0.25mm (x.xxx in ±0.01 in)

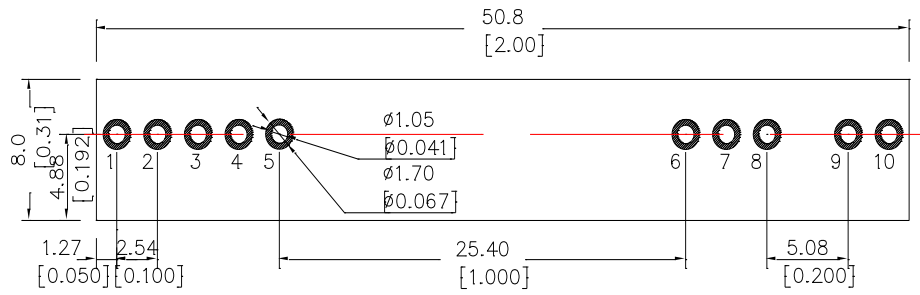

Component-side footprint

Recommended Hole Pattern for "R" suffix

Dimensions are in millimeters (inches)
Tolerances: x.x mm±0.5mm (x.xx in ±0.02 in);
x.xx mm±0.25mm (x.xxx in ±0.01 in)

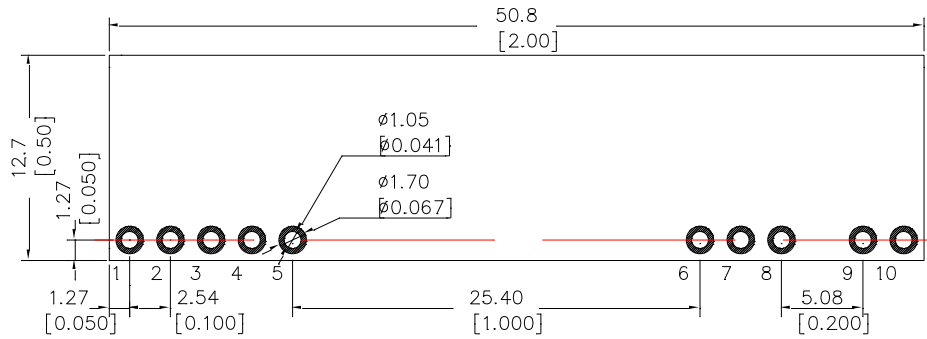

Component-side footprint

Application Notes

X-ON Electronics

Largest Supplier of Electrical and Electronic Components

Click to view similar products for [Isolated DC/DC Converters - Through Hole](#) category:

Click to view products by [Union](#) manufacturer:

Other Similar products are found below :

[F0505XT-2WR2](#) [F1515XT-2WR3](#) [WRF0505S-3WR2](#) [K7815M-1000R3](#) [B1215S-3WR2](#) [R-78E3.3-0.5](#) [K7812M-1000R3](#) [K7805-500R3](#)
[B0509XT-1WR3](#) [B0524XT-1WR3](#) [B1203XT-1WR3](#) [B1524S-3WR2](#) [B2424S-3WR2](#) [F0524D-2WR2](#) [B1212S-1W](#) [A1215S-2WR3](#)
[F1205XT-1WR3](#) [F0303XT-1WR3](#) [F0505D-1WR2](#) [K7805-500](#) [B0305S-1W](#) [F0509XT-1WR3](#) [K7805-1000R3](#) [F2424XT-1WR3](#)
[LZ4644IY#PBF](#) [K7805-500R3](#) [K7812-500R3](#) [G2415S-2WR3](#) [B2424LS-1WR3](#) [B1205S-1W](#) [F1212S-3WR2](#) [R-78E12-0.5](#) [K7805M-1000R3](#)
[B1224XT-1WR3](#) [H1205S-2WR2](#) [K7812-1000R3](#) [B1515S-2WR3](#) [B0505XT-2WR3](#) [F2424XT-2WR3](#) [B0505S-1WL](#) [F0505D-1WR3](#)
[F1224D-2WR3](#) [B1205S-2W](#) [A2405S-1WR3](#) [B2415S-3WR2](#) [R-78E5.0-0.5](#) [R-78E9.0-0.5](#) [B1515S-3WR2](#) [F1205XT-2WR3](#) [B2424XT-1WR3](#)