

300mA, Low Consumption, Wide Input Voltage Linear Regulator

UM142xxS SOT23-3

UM142xxY SOT89-3

UM142xxB SOT89-3

General Description

The UM142xx series are a group of positive voltage output, high precise, high PSRR and low power consumption voltage regulator. The output voltages are selectable in 100mV steps within a range of 2.5V to 5V. It also can be customized on command.

The UM142xx series have excellent load and line transient response and good temperature characteristics, which can assure the stability of chip and power system.

The UM142xx series are available in a low profile SOT23-3 & SOT89-3 package, which are lead (Pb)-free.

Applications

- Reference Voltage Source
- Battery Powered Equipment
- Hand-Hold Equipment
- Wireless LAN
- GPS Receivers

Features

- Low Quiescent Current: 8 μ A at 5V
- High PSRR: 60dB Range to 10kHz
- Low Output Noise: 44 μ V_{RMS}
- Low Dropout: 270mV at 150mA Load
- Low Temperature Coefficient: \pm 100ppm/ $^{\circ}$ C
- Excellent Line Regulation: 0.05%/V

Pin Configurations

Top View

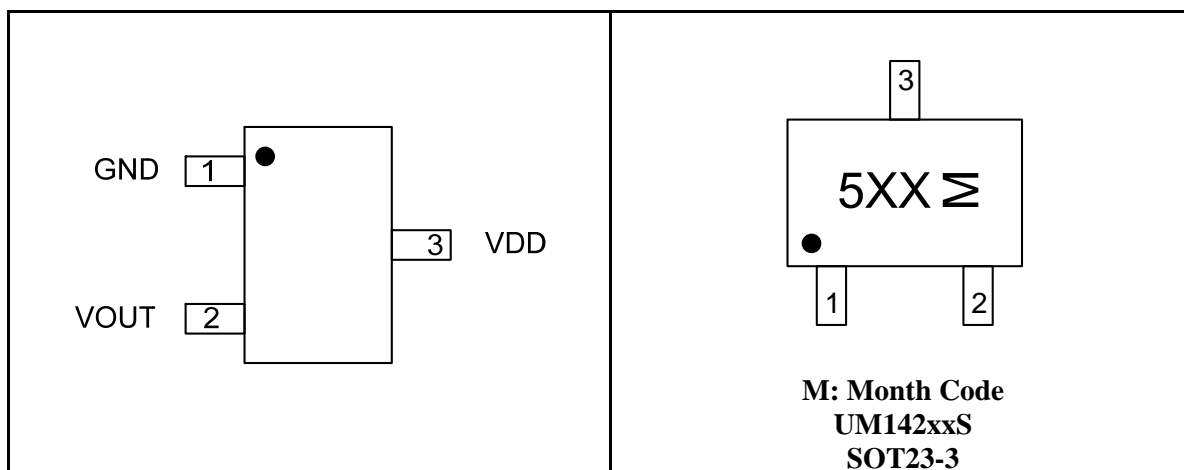

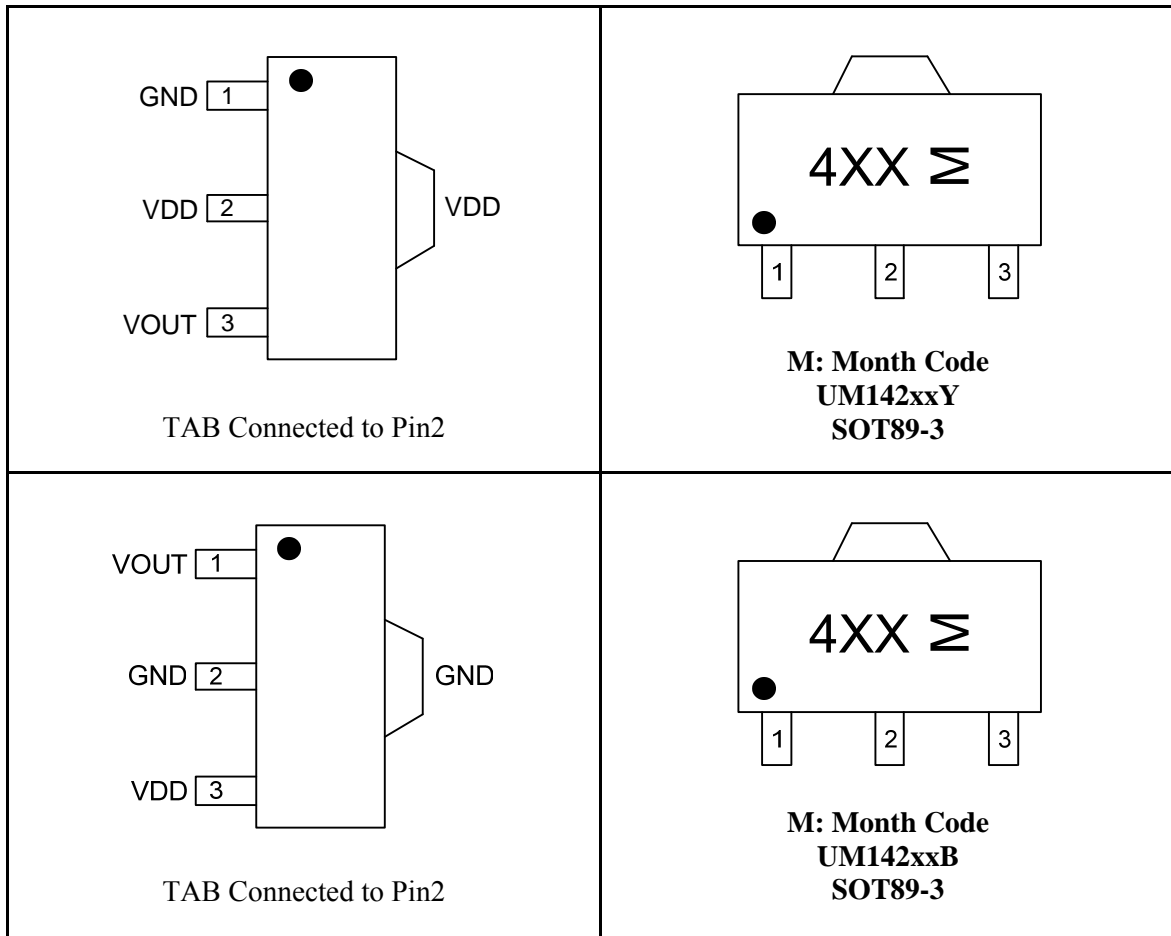

Ordering Information

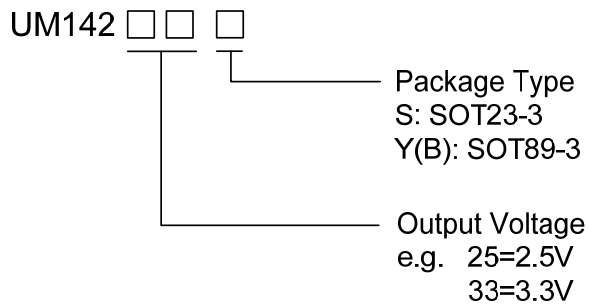

Marking Information

Part Number	Output Voltage	Packaging Type	Marking Code	Shipping Qty		
UM14225S	2.5V	SOT23-3	55A	3000pcs/7Inch Tape & Reel		
UM14226S	2.6V		55B			
UM14227S	2.7V		55C			
UM14228S	2.8V		55D			
UM14229S	2.9V		55E			
UM14230S	3.0V		55F			
UM14231S	3.1V		55H			
UM14232S	3.2V		55L			
UM14233S	3.3V		55M			
UM14234S	3.4V		55J			
UM14235S	3.5V		55K			
UM14236S	3.6V		55N			
UM14237S	3.7V		55P			
UM14238S	3.8V		55Q			
UM14239S	3.9V		55R			
UM14240S	4.0V		55S			
UM14241S	4.1V		55T			
UM14242S	4.2V		55Y			
UM14243S	4.3V		55U			
UM14244S	4.4V		55Z			
UM14245S	4.5V		56A			
UM14246S	4.6V		56B			
UM14247S	4.7V		56C			
UM14248S	4.8V		56D			
UM14249S	4.9V		56E			
UM14250S	5.0V		53F			
UM14225Y	2.5V		SOT89-3 (Tab connected to VDD)		4AA	1000pcs/7Inch Tape & Reel
UM14226Y	2.6V				4AB	
UM14227Y	2.7V	4AC				
UM14228Y	2.8V	4AD				
UM14229Y	2.9V	4AE				
UM14230Y	3.0V	4AF				
UM14231Y	3.1V	4AH				
UM14232Y	3.2V	4AL				
UM14233Y	3.3V	4AM				
UM14234Y	3.4V	4AJ				
UM14235Y	3.5V	4AK				
UM14236Y	3.6V	4AN				
UM14237Y	3.7V	4AP				
UM14238Y	3.8V	4AQ				
UM14239Y	3.9V	4AR				
UM14240Y	4.0V	4AS				
UM14241Y	4.1V	4AT				
UM14242Y	4.2V	4AY				
UM14243Y	4.3V	4AU				
UM14244Y	4.4V	4AZ				
UM14245Y	4.5V	4BA				
UM14246Y	4.6V	4BB				
UM14247Y	4.7V	4BC				
UM14248Y	4.8V	4BD				
UM14249Y	4.9V	4BE				
UM14250Y	5.0V	4BF				

Marking Information (Continued)

Part Number	Output Voltage	Packaging Type	Marking Code	Shipping Qty
UM14225B	2.5V	SOT89-3 (Tab connected to GND)	4CA	1000pcs/7Inch Tape & Reel
UM14226B	2.6V		4CB	
UM14227B	2.7V		4CC	
UM14228B	2.8V		4CD	
UM14229B	2.9V		4CE	
UM14230B	3.0V		4CF	
UM14231B	3.1V		4CH	
UM14232B	3.2V		4CL	
UM14233B	3.3V		4CM	
UM14234B	3.4V		4CJ	
UM14235B	3.5V		4CK	
UM14236B	3.6V		4CN	
UM14237B	3.7V		4CP	
UM14238B	3.8V		4CQ	
UM14239B	3.9V		4CR	
UM14240B	4.0V		4CS	
UM14241B	4.1V		4CT	
UM14242B	4.2V		4CY	
UM14243B	4.3V		4CU	
UM14244B	4.4V		4CZ	
UM14245B	4.5V		4DA	
UM14246B	4.6V		4DB	
UM14247B	4.7V		4DC	
UM14248B	4.8V		4DD	
UM14249B	4.9V		4DE	
UM14250B	5.0V	4DF		

Pin Description

Symbol	Function
GND	Ground
VOUT	Voltage Regulated Output
VDD	Supply Voltage Input

Absolute Maximum Ratings (Note 1)

Symbol	Parameter	Value	Unit
V_{IN}	Max Input Voltage	14	V
P_D	Power Dissipation	250	mW
T_J	Operating Junction Temperature	+125	°C
T_A	Ambient Temperature	-40 to +85	°C
T_{STG}	Storage Temperature Range	-40 to +150	°C
T_L	Lead Temperature for Soldering 10 Seconds	+260	°C

Note 1: Exposure to absolute maximum rating conditions may affect device reliability.

Recommended Work Condition

Symbol	Parameter	Value	Unit
V_{IN}	Max Input Voltage	12	V

Electrical Characteristics

(Test conditions: $C_{IN}=1.0\mu F$, $C_{OUT}=1.0\mu F$, $T_A=25^\circ C$, unless otherwise noted)

Symbol	Parameter	Test Conditions	Min	Typ	Max	Unit
V_{IN}	Input Voltage				12	V
V_{OUT}	Output Voltage	$V_{IN}=\text{Set } V_{OUT}+1V$ $1mA \leq I_{OUT} \leq 10mA$	$V_{OUT} \times 0.98$	$V_{OUT} \times 1.0$	$V_{OUT} \times 1.02$	V
$I_{OUT}(\text{Max})$ (Note 2)	Maximum Output Current	$V_{IN}-V_{OUT}=1V$	300			mA
V_{DROP}	Dropout Voltage	$I_{OUT}=150mA$		270		mV
	Output Voltage Accuracy	$I_{OUT}=300mA$	-3		+3	%
$\frac{\Delta V_{OUT}}{\Delta V_{IN} \cdot V_{OUT}}$	Line Regulation	$I_{OUT}=10mA$ $4V \leq V_{DD} \leq 6V$		0.05	0.2	%/V
ΔV_{OUT}	Load Regulation	$V_{IN}=\text{Set } V_{OUT}+1V$ $1mA \leq I_{OUT} \leq 300mA$		60		mV
I_S	Supply Current	$V_{IN}=\text{Set } V_{OUT}+1V$ V_{OUT} Floating		8	15	μA
$\frac{\Delta V_{OUT}}{\Delta T \cdot V_{OUT}}$	Output Voltage Noise	$I_{OUT}=10mA$		± 100		ppm/ $^\circ C$
PSRR	Power Supply Ripple Rejection	$f=100Hz$, Ripple=0.5Vp-p $V_{IN}=\text{Set } V_{OUT}+1V$		60		dB
	Output Noise	BW=10Hz~100kHz		44		μV_{RMS}

Note 2: The maximum power rating of each package is constant, so along with the change of I_{LOAD} , the $V_{IN}-V_{OUT}$ should be controlled to a certain range to ensure the normal operation.

Typical Application Circuit

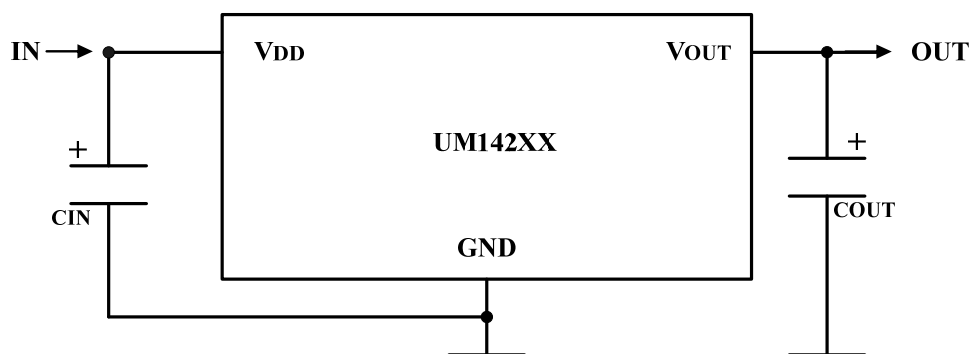

Note 3: Input Capacitor ($C_{IN}=1\mu F$) is recommended in all applications.

Note 4: Output Capacitor ($C_{OUT}=1\mu F/6.8\mu F$) is recommended in all applications to assure the stability of circuit. $1\mu F$ Tantalum capacitor or $6.8\mu F$ ceramic capacitor is recommended.

Typical Operating Characteristics

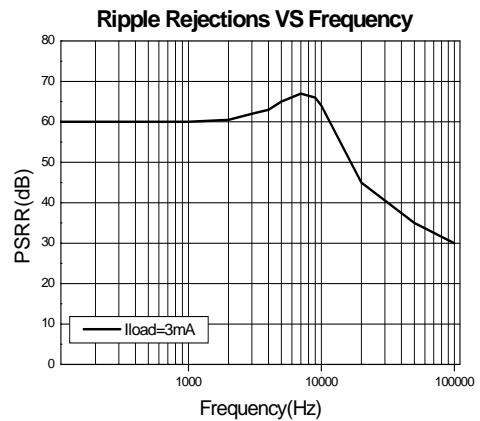
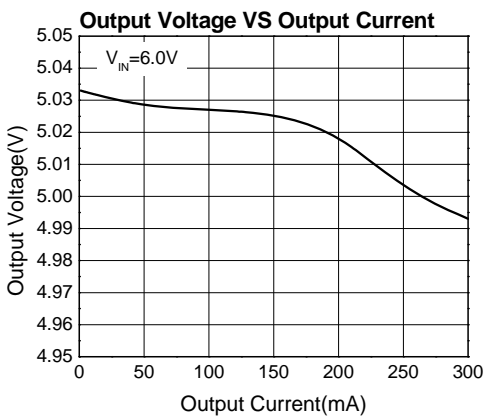
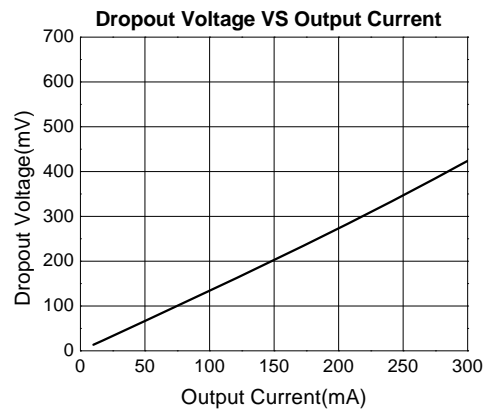
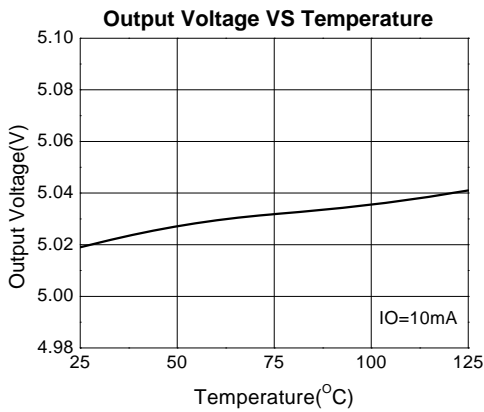
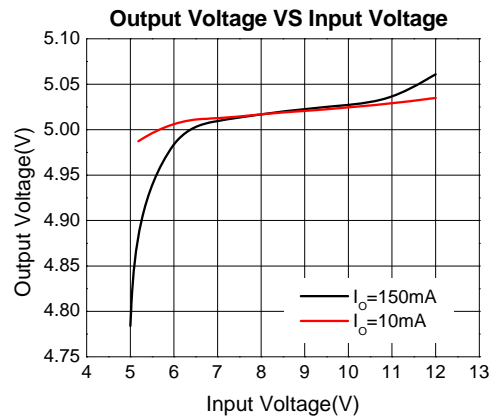
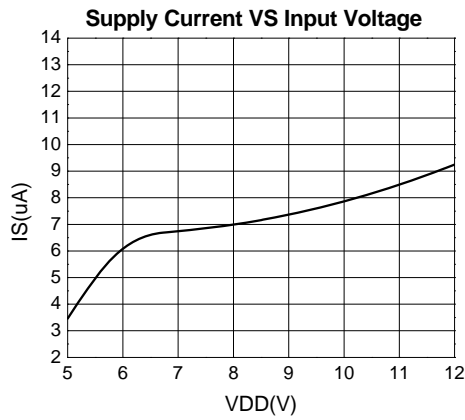

Package Information

UM142xxS: SOT23-3

Outline Drawing

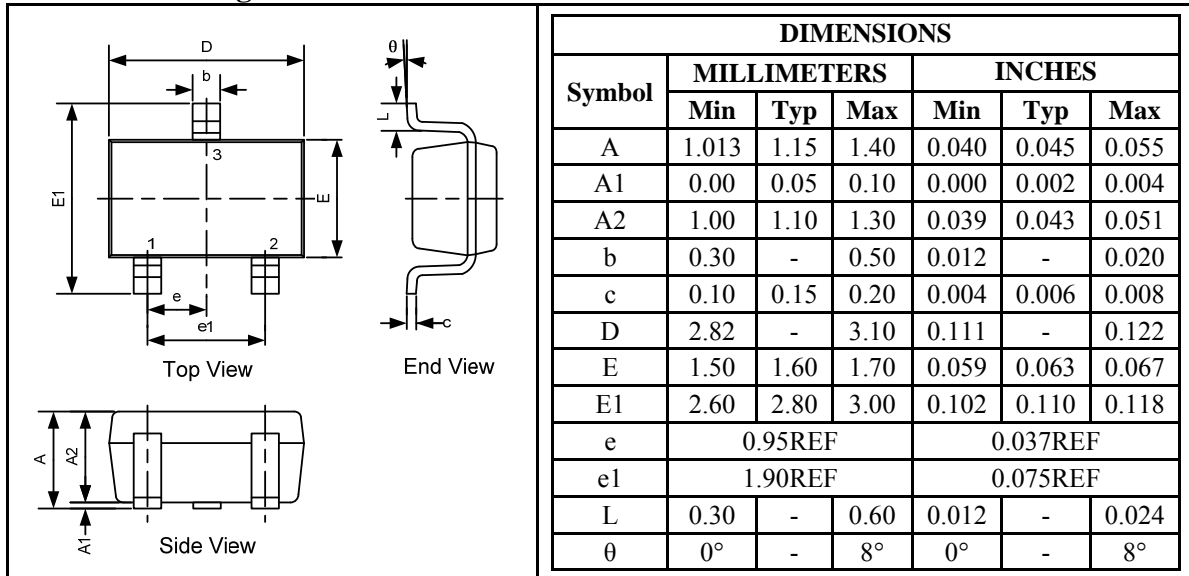

Land Pattern

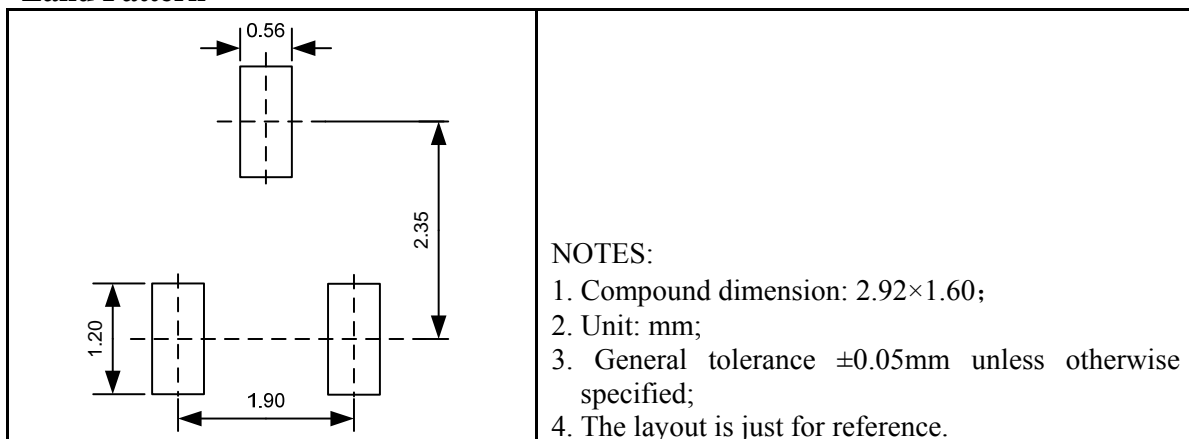

Tape and Reel Orientation

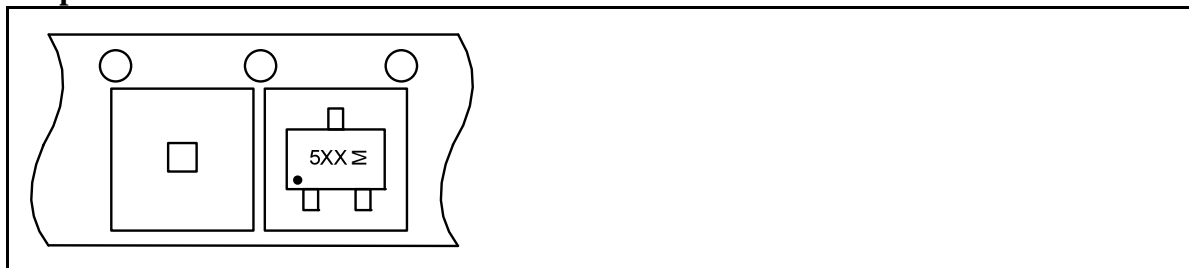

UM142xxY(B): SOT89-3

Outline Drawing

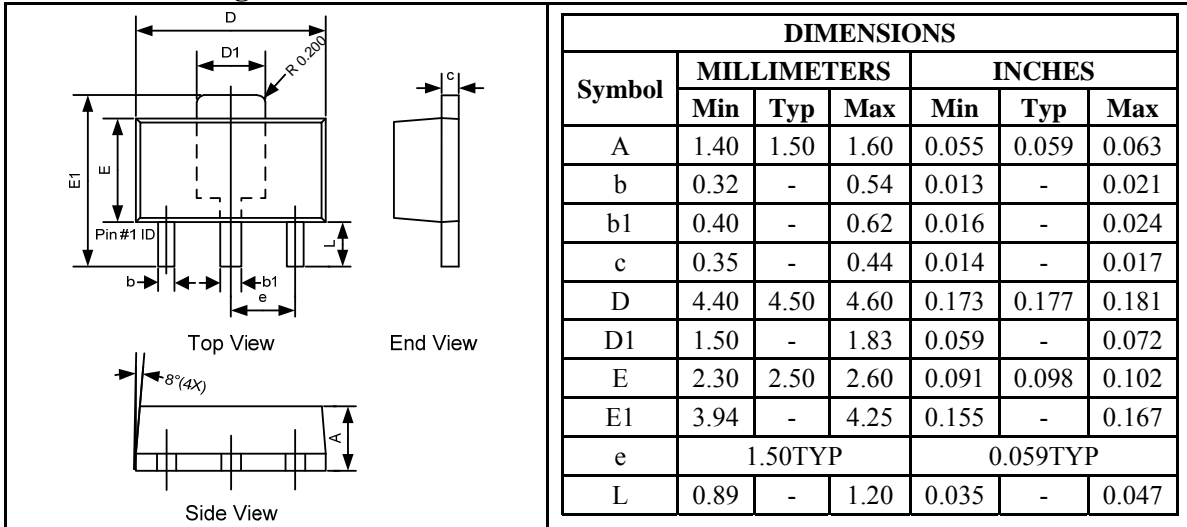

Land Pattern

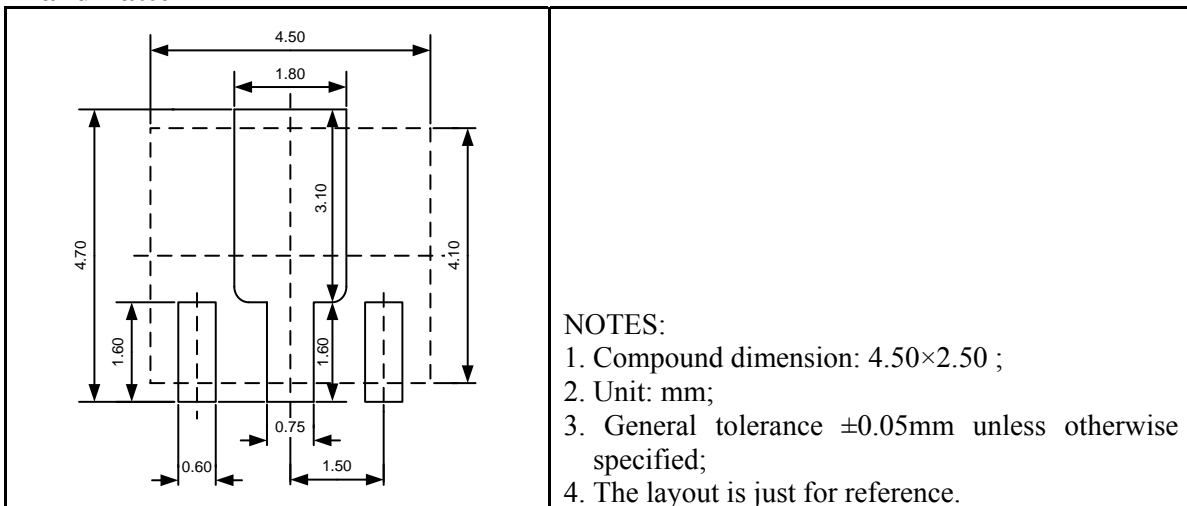

Tape and Reel Orientation

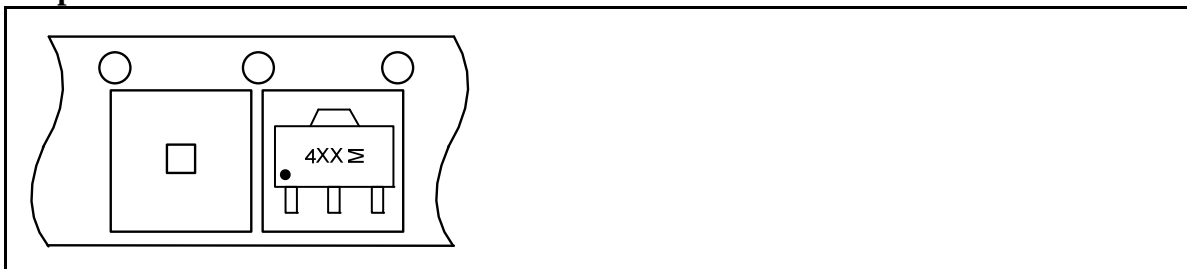

GREEN COMPLIANCE

Union Semiconductor is committed to environmental excellence in all aspects of its operations including meeting or exceeding regulatory requirements with respect to the use of hazardous substances. Numerous successful programs have been implemented to reduce the use of hazardous substances and/or emissions.

All Union components are compliant with the RoHS directive, which helps to support customers in their compliance with environmental directives. For more green compliance information, please visit:

http://www.union-ic.com/index.aspx?cat_code=RoHSDeclaration

IMPORTANT NOTICE

The information in this document has been carefully reviewed and is believed to be accurate. Nonetheless, this document is subject to change without notice. Union assumes no responsibility for any inaccuracies that may be contained in this document, and makes no commitment to update or to keep current the contained information, or to notify a person or organization of any update. Union reserves the right to make changes, at any time, in order to improve reliability, function or design and to attempt to supply the best product possible.



Union Semiconductor, Inc

Add: Unit 606, No.570 Shengxia Road, Shanghai 201210

Tel: 021-51093966

Fax: 021-51026018

Website: www.union-ic.com

X-ON Electronics

Largest Supplier of Electrical and Electronic Components

Click to view similar products for [Linear Voltage Regulators](#) category:

Click to view products by [Union](#) manufacturer:

Other Similar products are found below :

[LV5684PVD-XH](#) [MCDTSA6-2R](#) [L7815ACV-DG](#) [LV56801P-E](#) [UA7805CKC](#) [714954EB](#) [ZMR500QFTA](#) [BA033LBSG2-TR](#)
[NCV78M05ABDTRKG](#) [LV5680P-E](#) [L79M05T-E](#) [L78LR05D-MA-E](#) [NCV317MBTG](#) [NTE7227](#) [MP2018GZD-33-P](#) [MP2018GZD-5-P](#)
[LV5680NPVC-XH](#) [ZTS6538SE](#) [UA78L09CLP](#) [UA78L09CLPR](#) [CAT6221-PPTD-GT3](#) [MC78M09CDTRK](#) [NCV51190MNTAG](#)
[BL1118CS8TR1833](#) [BL8077CKETR33](#) [BL9153-33CC3TR](#) [BL9161G-28BADRN](#) [BRCO7530MMC](#) [CJ7815B-TFN-ARG](#) [LM317C](#)
[GM7333K](#) [GM7350K](#) [XC6206P332MR](#) [HT7533](#) [LM7912S/TR](#) [LT1764S/TR](#) [LM7805T](#) [LM338T](#) [LM1117IMP-3.3/TR](#) [HT1117AM-3.3](#)
[HT7550S](#) [AMS1117-3.3](#) [HT7150S](#) [78L12](#) [HT7550](#) [HT7533-1](#) [HXY6206I-2.5](#) [HT7133](#) [HT7533S](#) [662K](#)