Ultra Low Quiescent Current Linear Regulator**UM153xxS SOT23-3****UM153xxY SOT89-3****UM154xxS SOT23-5****UM154xxY SOT89-5****UM154xxDA DFN6L 2.0×2.0****General Description**

The UM153xx/UM154xx series are ultra low quiescent current low dropout linear regulators designed for low power portable applications. The range of output voltage is from 1.3V to 5.0V while operated from 2.2V to 5.5V input. The EN function of UM154xx can disable the entire circuit by inputting low level signal.

The UM153xx/UM154xx series offer high output voltage accuracy, excellent transient response, stability with ultra low ESR ceramic capacitors as small as 1 μ F, thermal overload protection and output current limiting. The UM153xx is available in a low profile SOT23-3 or SOT89-3 package. The UM154xx is available in a low profile SOT23-5, SOT89-5 or DFN6L 2.0×2.0 package.

Applications

- Battery-Powered Systems
- Reference Voltage Sources
- Portable AV Systems
- Portable Games
- Cellular Phones
- Utility Meters
- Toys

Features

- Maximum Input Voltage: 5.5V
- $\pm 2.0\%$ Voltage Accuracy at 30mA
- Fast Transient Response
- Output Current Limit
- Stable with 1 μ F Output Capacitor
- Thermal Overload Protection
- Low Profile SOT23-3 or SOT89-3 Package (UM153xx)
Low Profile SOT23-5, SOT89-5 or DFN6L 2.0×2.0 Package (UM154xx)

UM153xx Series Pin Configurations & Top View

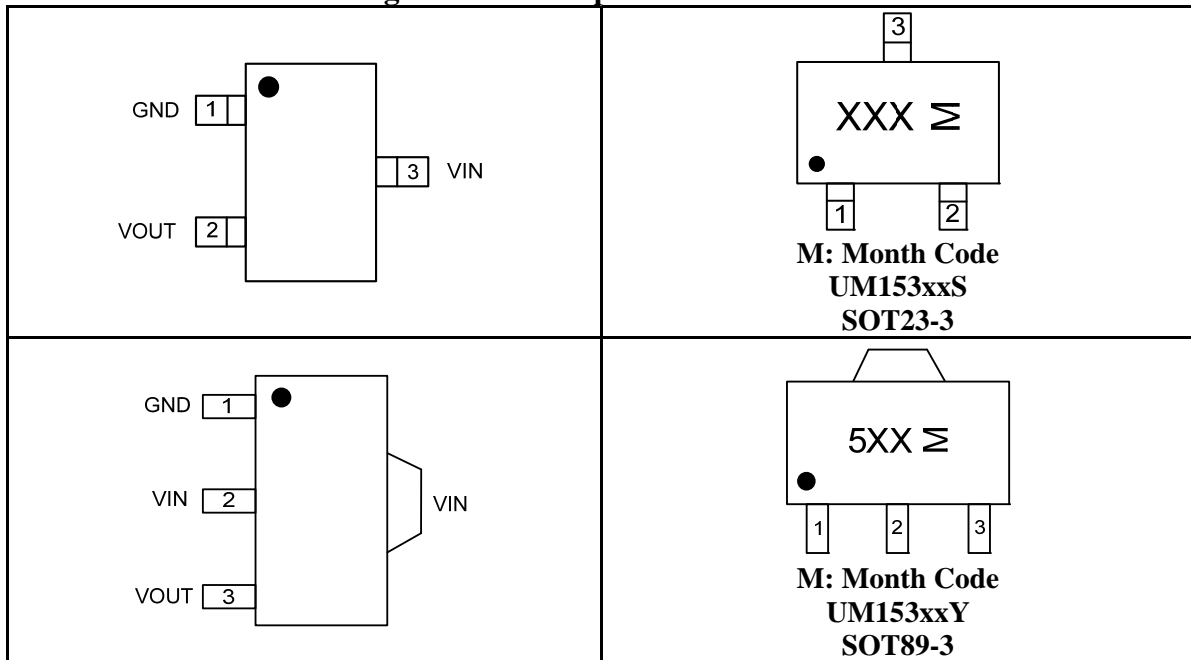

UM154xx Series Pin Configurations & Top View

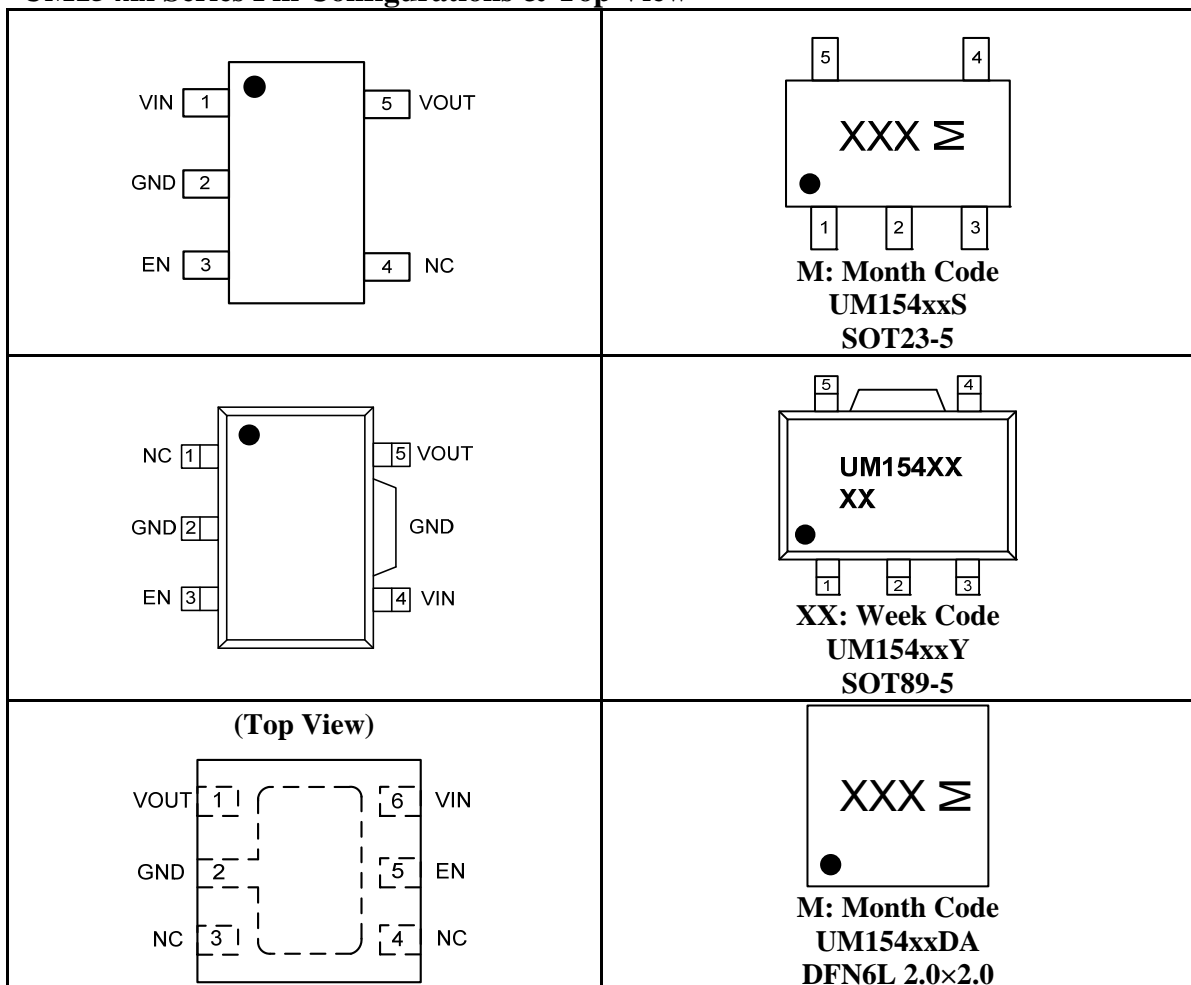

Pin Description

Pin Number					Symbol	Function
UM153xxS	UM153xxY	UM154xxS	UM154xxY	UM154xxDA		
3	2	1	4	6	VIN	Power Supply
1	1	2	2	2	GND	Ground
-	-	3	3	5	EN	Enable Input, Active High
-	-	4	1	3, 4	NC	Not Connected
2	3	5	5	1	VOUT	Voltage Regulated Output

Available Voltage Version

Part Number	Output Voltage	Marking Code	Package	Shipping Qty
UM15313S	1.3V	UC3	SOT23-3	3000pcs/7Inch Tape & Reel
UM15315S	1.5V	UC5		
UM15318S	1.8V	UC8		
UM15325S	2.5V	UD5		
UM15327S	2.7V	UD7		
UM15328S	2.8V	UD8		
UM15330S	3.0V	UDA		
UM15333S	3.3V	UG3		
UM15335S	3.5V	UG5		
UM15336S	3.6V	UG6		
UM15338S	3.8V	UG8		
UM15340S	4.0V	UGA		
UM15342S	4.2V	UI2		
UM15343S	4.3V	UI3		
UM15345S	4.5V	UI5		
UM15347S	4.7V	UI7		
UM15348S	4.8V	UI8		
UM15350S	5.0V	UIA		

Available Voltage Version (Continued)

Part Number	Output Voltage	Marking Code	Package	Shipping Qty
UM15313Y	1.3V	5A3	SOT89-3	1000pcs/7Inch Tape & Reel
UM15315Y	1.5V	5C5		
UM15318Y	1.8V	5C8		
UM15325Y	2.5V	5D5		
UM15327Y	2.7V	5D7		
UM15328Y	2.8V	5D8		
UM15330Y	3.0V	5AA		
UM15333Y	3.3V	5G3		
UM15335Y	3.5V	5G5		
UM15336Y	3.6V	5G6		
UM15338Y	3.8V	5G8		
UM15340Y	4.0V	5GA		
UM15342Y	4.2V	5GC		
UM15343Y	4.3V	5GD		
UM15345Y	4.5V	5GH		
UM15347Y	4.7V	5GM		
UM15348Y	4.8V	5GJ		
UM15350Y	5.0V	5GN		
UM15413S	1.3V	5FB	SOT23-5	3000pcs/7Inch Tape & Reel
UM15415S	1.5V	5FC		
UM15418S	1.8V	5FD		
UM15425S	2.5V	5FE		
UM15427S	2.7V	5FF		
UM15428S	2.8V	5FH		
UM15430S	3.0V	5FL		
UM15433S	3.3V	5FM		
UM15435S	3.5V	5FJ		
UM15436S	3.6V	5FK		
UM15438S	3.8V	5FN		
UM15440S	4.0V	5FP		
UM15442S	4.2V	5FQ		
UM15443S	4.3V	5FR		
UM15445S	4.5V	5FS		
UM15447S	4.7V	5FT		
UM15448S	4.8V	5FY		
UM15450S	5.0V	5FU		

Available Voltage Version (Continued)

Part Number	Output Voltage	Marking Code	Package	Shipping Qty
UM15413Y	1.3V	UM15413	SOT89-5	1000pcs/7Inch Tape & Reel
UM15415Y	1.5V	UM15415		
UM15418Y	1.8V	UM15418		
UM15425Y	2.5V	UM15425		
UM15427Y	2.7V	UM15427		
UM15428Y	2.8V	UM15428		
UM15430Y	3.0V	UM15430		
UM15433Y	3.3V	UM15433		
UM15435Y	3.5V	UM15435		
UM15436Y	3.6V	UM15436		
UM15438Y	3.8V	UM15438		
UM15440Y	4.0V	UM15440		
UM15442Y	4.2V	UM15442		
UM15443Y	4.3V	UM15443		
UM15445Y	4.5V	UM15445		
UM15447Y	4.7V	UM15447		
UM15448Y	4.8V	UM15448		
UM15450Y	5.0V	UM15450		
UM15413DA	1.3V	AG2	DFN6L 2.0×2.0	3000pcs/7Inch Tape & Reel
UM15415DA	1.5V	AG3		
UM15418DA	1.8V	AG4		
UM15425DA	2.5V	AG5		
UM15427DA	2.7V	AG6		
UM15428DA	2.8V	AG7		
UM15430DA	3.0V	AG8		
UM15433DA	3.3V	AG9		
UM15435DA	3.5V	AGA		
UM15436DA	3.6V	AGB		
UM15438DA	3.8V	AGC		
UM15440DA	4.0V	AGD		
UM15442DA	4.2V	AGE		
UM15443DA	4.3V	AGF		
UM15445DA	4.5V	AGG		
UM15447DA	4.7V	AGH		
UM15448DA	4.8V	AGJ		
UM15450DA	5.0V	AGK		

Absolute Maximum Ratings (Note 1)

Symbol	Parameter	Value	Unit
V _{IN}	Supply Voltage on IN Pin	-0.3 to +6.5	V
V _{OUT}	Voltage on OUT Pin	-0.3 to +6.5	V
V _{EN}	Voltage on EN Pin	-0.3 to +6.5	V
T _J	Operating Junction Temperature (Note 2, 3)	-40 to +125	°C
T _{STG}	Storage Temperature Range	-65 to +150	°C
T _L	Lead Temperature for Soldering 10 Seconds	+300	°C

Recommended Operating Conditions (Note 4)

Parameter	Value
Supply Input Voltage	2.2 V to 5.5V
Junction Temperature Range	-40°C to 125°C
Ambient Temperature Range	-40°C to 85°C

Note 1: Absolute Maximum Ratings are those values beyond which the life of a device may be impaired.

Note 2: The device is guaranteed to meet performance specifications from -40°C to +85°C. Specifications over the -40°C to 125°C operating junction temperature range are guaranteed by design, characterization and correlation with statistical process controls.

Note 3: This IC includes over temperature protection circuit inside that is intended to protect the device during momentary overload conditions. Over temperature protection trip point is around 160°C. Continuous operation above the specified maximum operating junction temperature may impair device reliability.

Note 4: The device is not guaranteed to function outside its operating conditions.

Internal Block Diagram

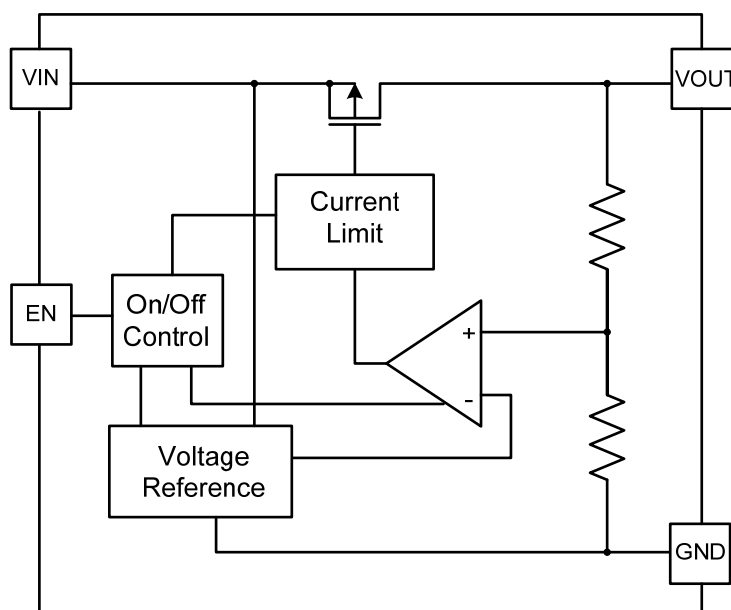

Electrical Characteristics

$V_{IN}=+5V\pm 10\%$, $C_{IN}=1\mu F$, $C_{OUT}=1\mu F$, $T_A=-40^{\circ}C$ to $+85^{\circ}C$. Typical conditions are at $V_{IN}=5V$, $T_A=25^{\circ}C$.

Symbol	Parameter	Test Conditions	Min	Typ	Max	Unit
V_{IN}	Input Voltage Range		2.2		5.5	V
V_{OUT}	Output Voltage Range		1.3		5.0	V
I_Q	Quiescent Current	$I_{OUT}=0mA, V_{IN}=5.0V$		1.2	3	μA
I_{SHDN}	Standby Current	$V_{EN}=0V$			2	μA
I_{ENH}	Enable High Current	$V_{EN}=5.5V$			1	μA
I_{ENL}	Enable Low Current	$V_{EN}=0V$			1	μA
V_{IH}	Enable Input High Voltage		1.0			V
V_{IL}	Enable Input Low Voltage				0.4	V
I_{OUT}	Output Current	$V_{IN}\geq 3V$	100			mA
		$V_{IN}\geq 3.5V$	200			mA
	Output Voltage Accuracy	$V_{IN}=V_{OUT}+1V$ ($V_{IN}\geq 3V$), $1mA\leq I_{OUT}\leq 30mA$	-2.0		+2.0	%
ΔV_{DO}	Dropout Voltage	$V_{OUT}\leq 2.0V, I_{OUT}=30mA$			$2.35-V_{OUT}$	V
		$2.0V<V_{OUT}<2.5V,$ $I_{OUT}=30mA$			0.25	
		$V_{OUT}\geq 2.5V, I_{OUT}=30mA$			0.13	
I_{LIMIT}	Current Limit			300		mA
	Output Voltage TC			150		ppm/ $^{\circ}C$
T_{SHDN}	Thermal-Shutdown Temperature			160		$^{\circ}C$
ΔT_{SHDN}	Thermal-Shutdown Hysteresis			20		$^{\circ}C$
	Line Regulation	$V_{OUT}+1V\leq V_{IN}\leq 5.5V$ ($V_{IN}\geq 3V$), $I_{OUT}=30mA$		± 0.3	± 0.5	%
	Load Regulation	$V_{IN}=V_{OUT}+1V$ ($V_{IN}\geq 3V$), $1mA\leq I_{OUT}\leq 100mA$		10		mV
	Output Voltage Noise	10-100kHz, $C_{IN}=1\mu F$, $I_{OUT}=1mA$, UM15318S		170		μV_{RMS}
PSRR	Power Supply Ripple Rejection	$V_{IN}=V_{OUT}+1V$ $I_{OUT}=10mA$	$f=10Hz$		55	dB
			$f=100Hz$		45	
			$f=1kHz$		45	

Typical Performance Characteristics

Quiescent Current vs. Input Voltage

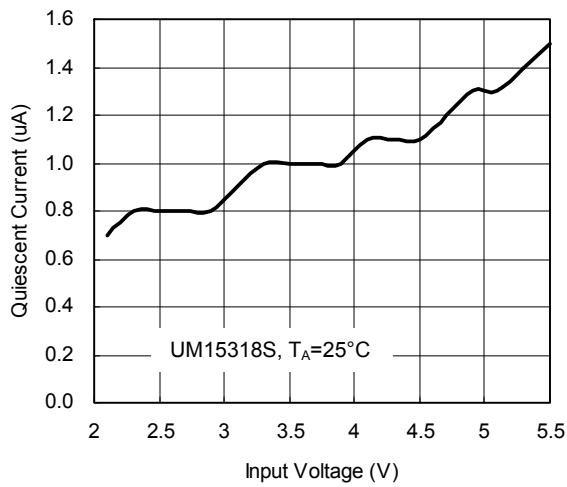

Quiescent Current vs. Ambient Temperature

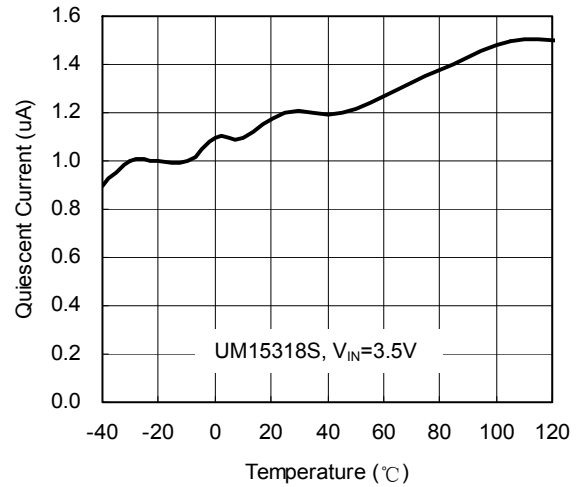

Output Voltage vs. Input Voltage

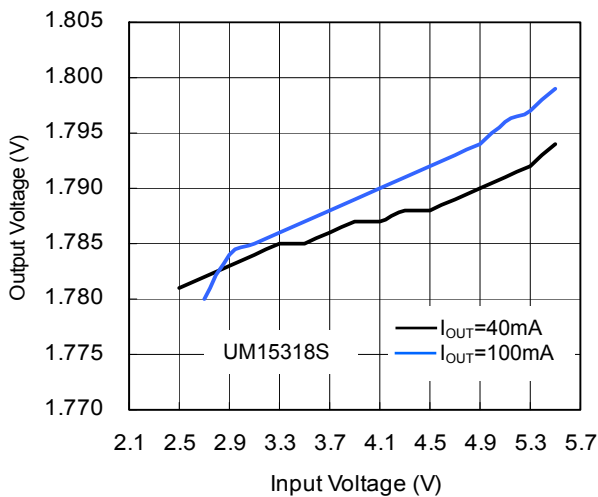

Output Voltage vs. Ambient Temperature

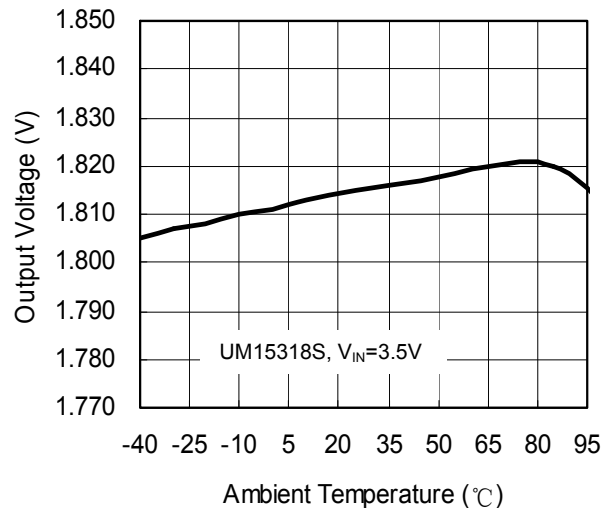

Output Voltage vs. Output Current

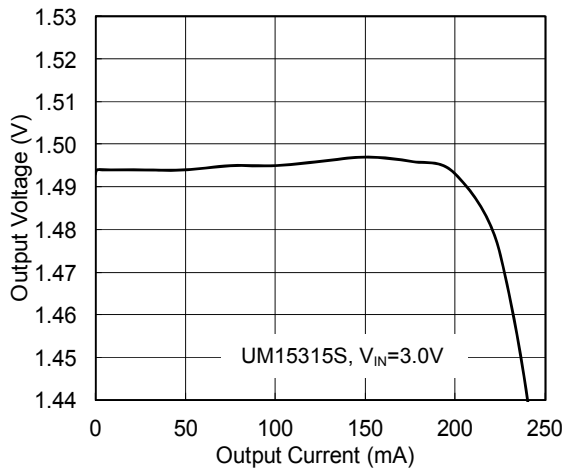

Output Voltage vs. Output Current

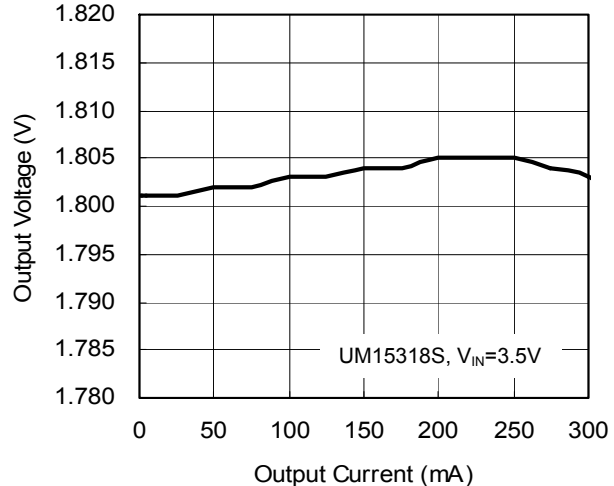

Typical Performance Characteristics (Continued)

Output Voltage vs. Output Current

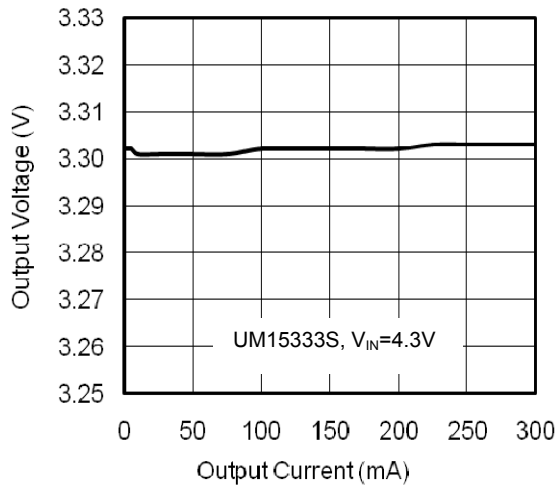

Dropout Voltage vs. Output Current

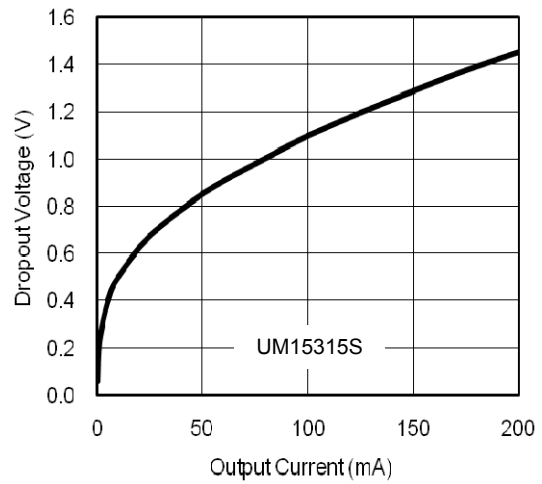

Dropout Voltage vs. Output Current

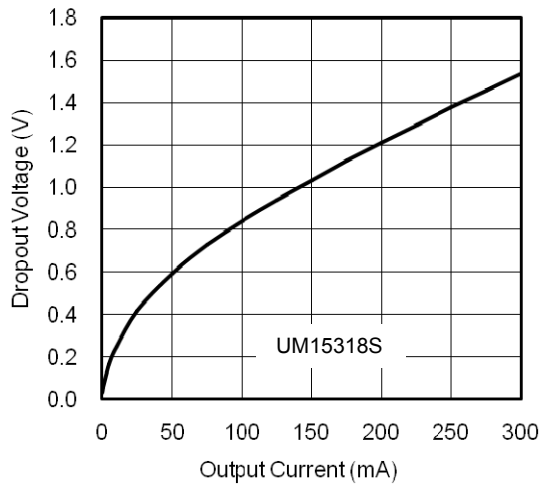

Dropout Voltage vs. Output Current

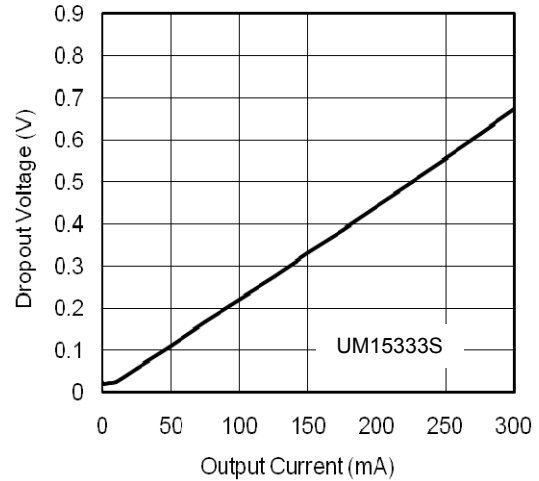

Line Transient Response

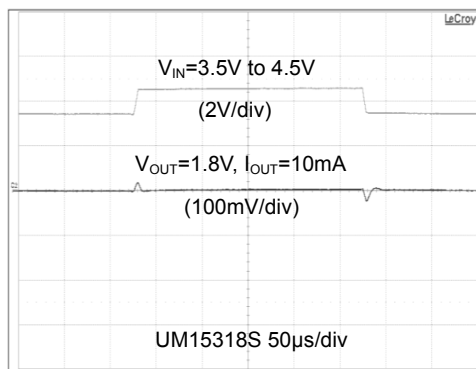

Load Transient Response

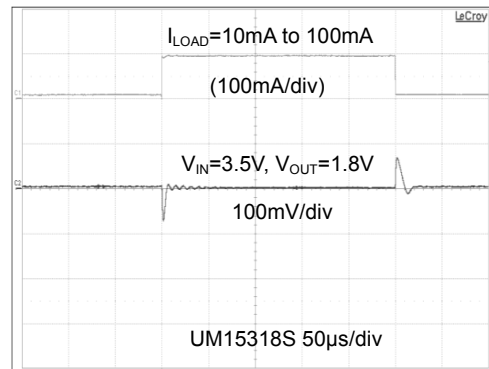

Typical Performance Characteristics (Continued)

PSRR vs. Frequency

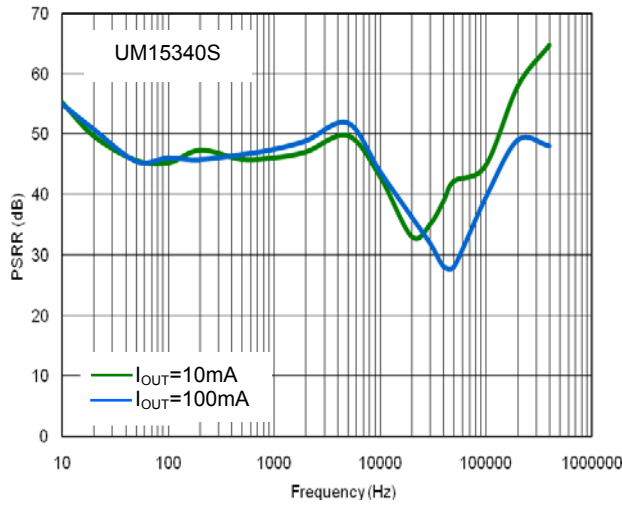

Typical Application Circuit

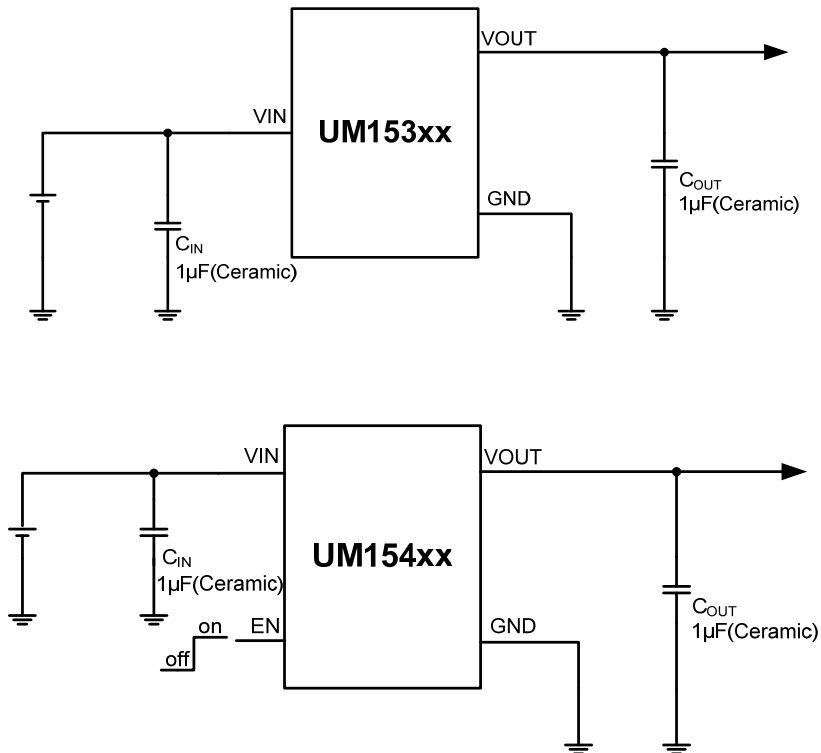

Applications Information

Output Capacitance and Transient Response

The UM153xx/UM154xx series regulators are designed to be stable with a wide range of output capacitors. The ESR of the output capacitor affects stability, most notably with small capacitors. A minimum output capacitor of 1 μ F with an ESR of 0.3 Ω or less is recommended to ensure stability. The device's output transient response will be a function of output capacitance. Larger values of output capacitance decrease the peak deviations and provide improved transient response for larger load current changes. Extra consideration must be given to the use of ceramic capacitors. The X5R and X7R dielectrics result in more stable characteristics and are more suitable for use as the output capacitor. The X7R type has better stability across temperature, while the X5R is less expensive and is available in higher values.

Thermal Protection

Thermal protection disables the output when the junction temperature rises to approximately +160°C allowing the device to cool. When the junction temperature cools to approximately +140°C the output circuit is again enabled.

Package Information

UM153xxS SOT23-3

Outline Drawing

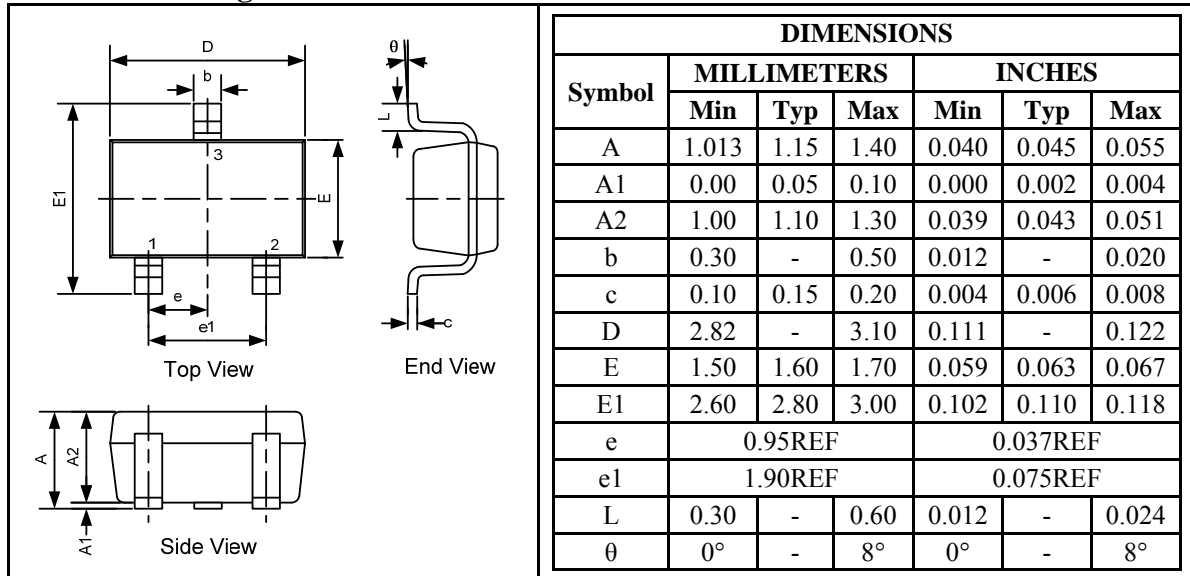

Land Pattern

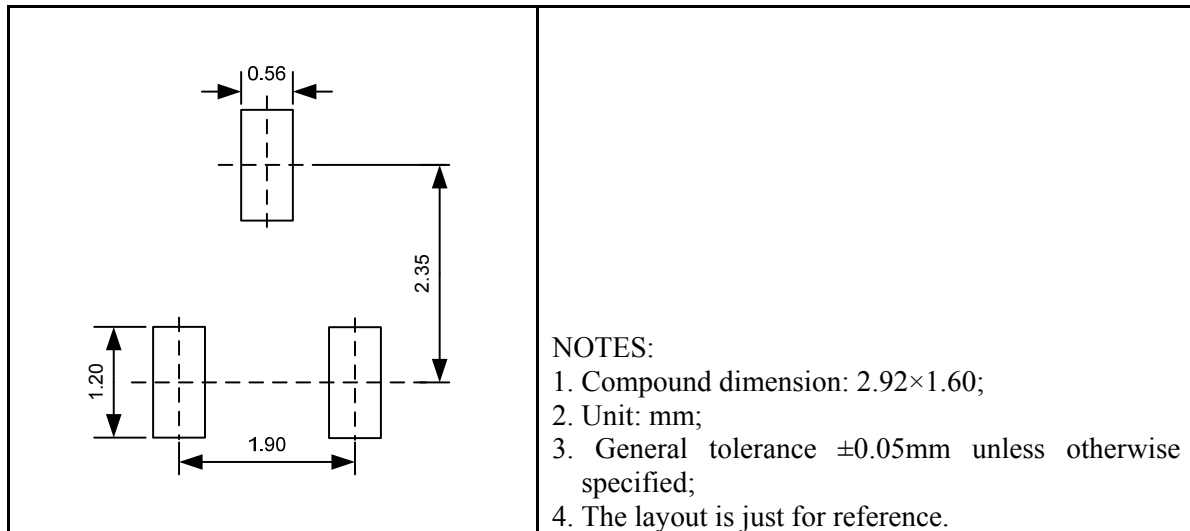

Tape and Reel Orientation



UM153xxY SOT89-3

Outline Drawing

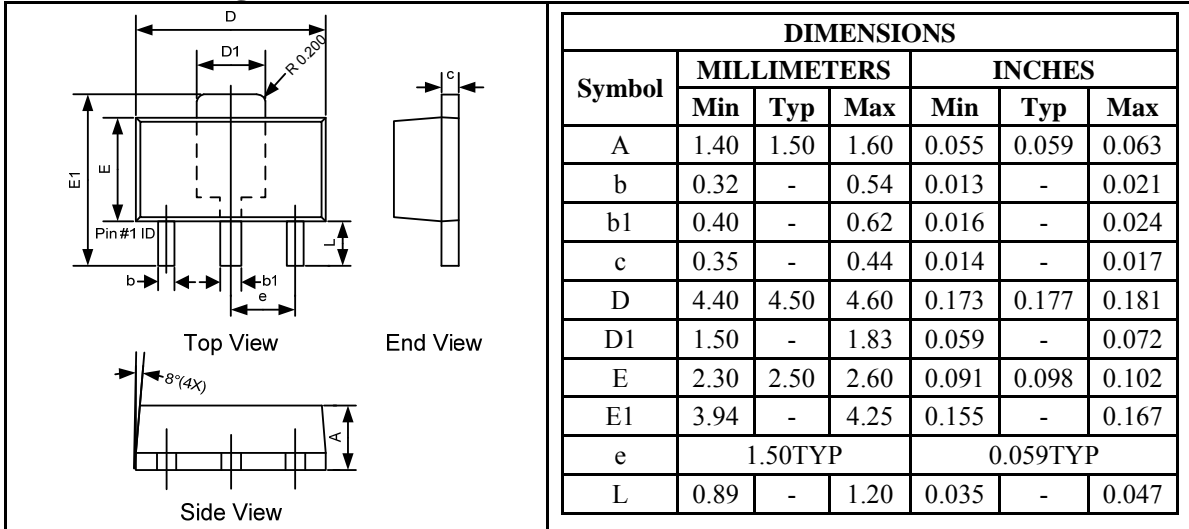

Land Pattern

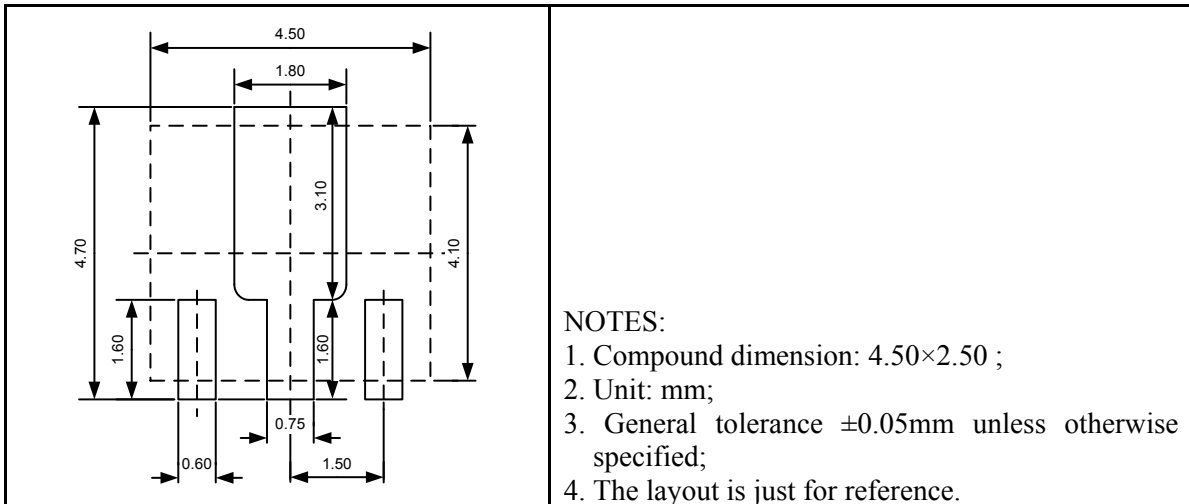

Tape and Reel Orientation



UM154xxS SOT23-5

Outline Drawing

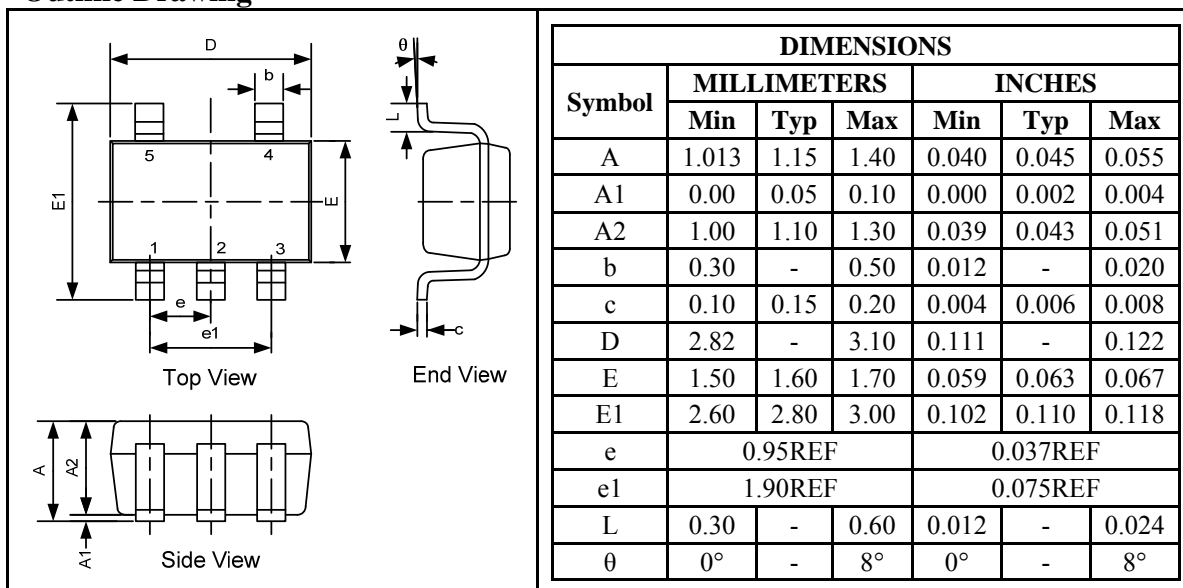

Land Pattern

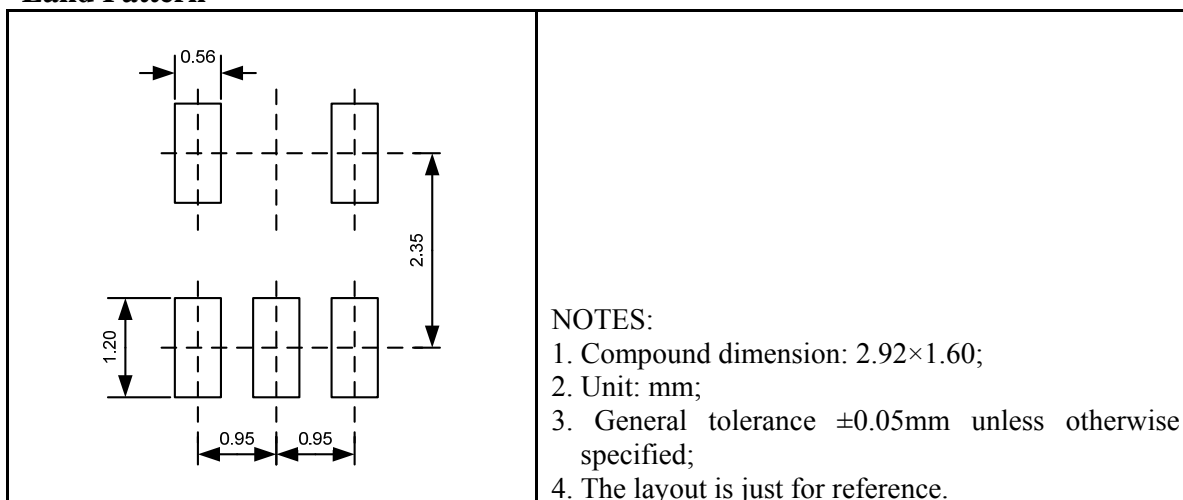

Tape and Reel Orientation



UM154xxY SOT89-5

Outline Drawing

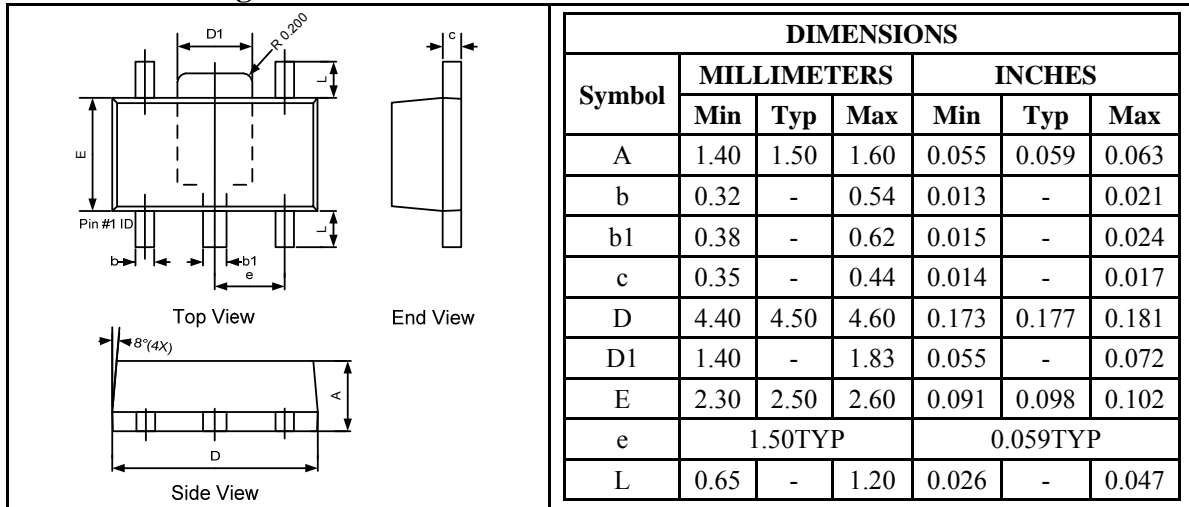

Land Pattern

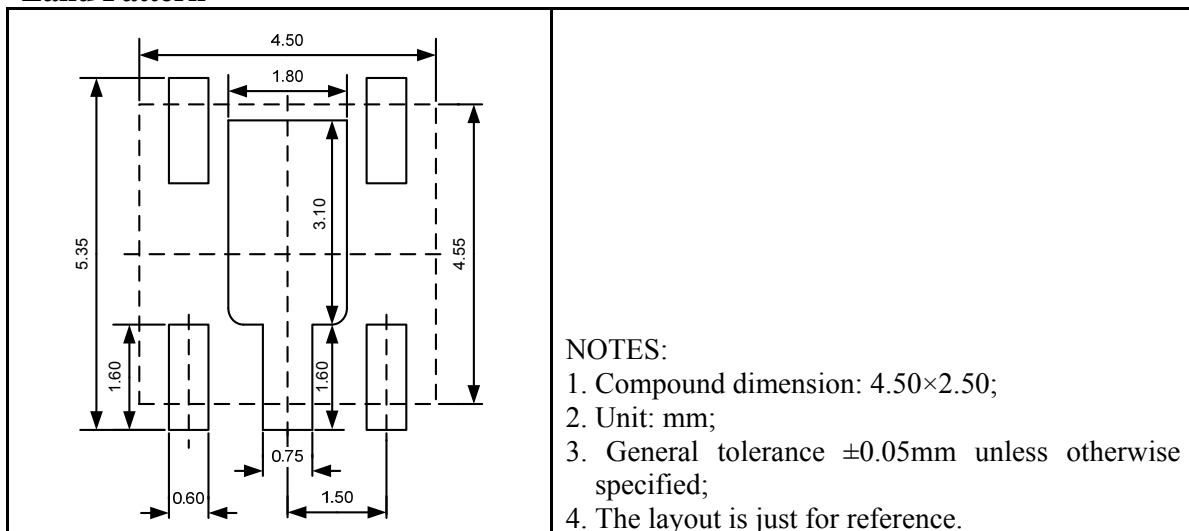

Tape and Reel Orientation



UM154xxDA DFN6L 2.0×2.0

Outline Drawing

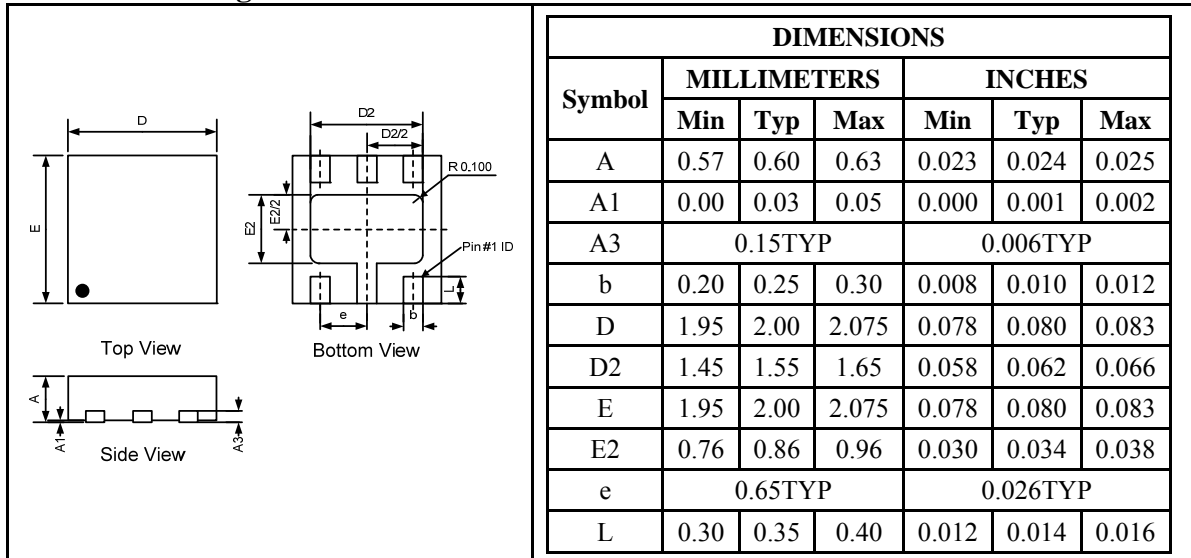

Land Pattern

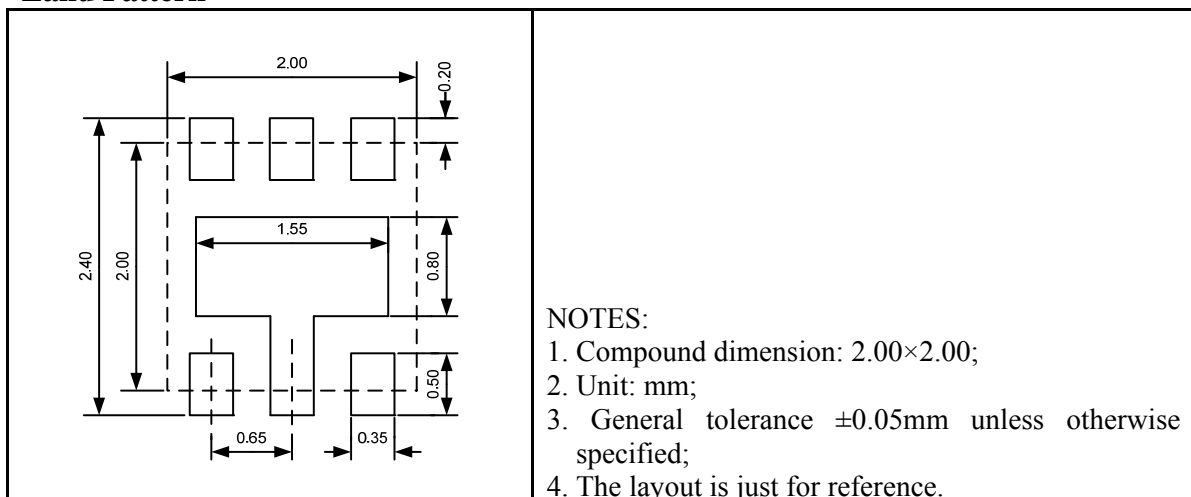

Tape and Reel Orientation



GREEN COMPLIANCE

Union Semiconductor is committed to environmental excellence in all aspects of its operations including meeting or exceeding regulatory requirements with respect to the use of hazardous substances. Numerous successful programs have been implemented to reduce the use of hazardous substances and/or emissions.

All Union components are compliant with the RoHS directive, which helps to support customers in their compliance with environmental directives. For more green compliance information, please visit:

http://www.union-ic.com/index.aspx?cat_code=RoHSDeclaration

IMPORTANT NOTICE

The information in this document has been carefully reviewed and is believed to be accurate. Nonetheless, this document is subject to change without notice. Union assumes no responsibility for any inaccuracies that may be contained in this document, and makes no commitment to update or to keep current the contained information, or to notify a person or organization of any update. Union reserves the right to make changes, at any time, in order to improve reliability, function or design and to attempt to supply the best product possible.

X-ON Electronics

Largest Supplier of Electrical and Electronic Components

Click to view similar products for [Linear Voltage Regulators](#) category:

Click to view products by [Union manufacturer](#):

Other Similar products are found below :

[LV56831P-E](#) [LV5684PVD-XH](#) [MCDTSA6-2R](#) [L4953G](#) [L7815ACV-DG](#) [PQ3DZ53U](#) [LV56801P-E](#) [TCR3DF13,LM\(CT](#)
[TCR3DF39,LM\(CT](#) [TLE42794G](#) [L78L05CZ/1SX](#) [L78LR05DL-MA-E](#) [L78MR05-E](#) [033150D](#) [033151B](#) [090756R](#) [636416C](#)
[NCV78M15BDTG](#) [702482B](#) [714954EB](#) [TLE42794GM](#) [TLE42994GM](#) [ZMR500QFTA](#) [BA033LBSG2-TR](#) [NCV78M05ABDTRKG](#)
[NCV78M08BDTRKG](#) [NCP7808TG](#) [NCV571SN12T1G](#) [LV5680P-E](#) [CAJ24C256YI-GT3](#) [L78M15CV-DG](#) [L9474N](#)
[TLS202B1MBV33HTSA1](#) [L79M05T-E](#) [NCP571SN09T1G](#) [MAX15006AASA/V+](#) [MIC5283-5.0YML-T5](#) [L4969URTR-E](#) [L78LR05D-MA-E](#)
[NCV7808BDTRKG](#) [L9466N](#) [NCP7805ETG](#) [SC7812CTG](#) [NCV7809BTG](#) [NCV571SN09T1G](#) [NCV317MBTG](#) [MC78M15CDTT5G](#)
[MC78M12CDTT5G](#) [L9468N](#) [LT1054IS8#TRPBF](#)