

Low Power, High ESD +5V RS-232 Transceivers***UM207EESO/UM207EEAO/UM207EEAOR/UM207EEUO******UM208EESO/UM208EEAO/UM208EEAOR/UM208EEUO******UM211EESS/UM211EEAS/UM211EEASR/UM211EEUS******UM213EESS/UM213EEAS/UM213EEASR/UM213EEUS*****General Description**

The UM207/208/211/213 are enhanced transceivers intended for use in RS-232 and V.28 serial communication and are particularly suited for those applications where $\pm 12V$ is not available. These devices feature very low power consumption and +5V single supply operation making them ideal for space-constrained applications. With integrated charge pump circuitry and small 0.1 μ F charge pump capacitors, these devices can fully meet RS-232 voltage levels. A slow rate limited transmitter circuit improves data integrity. The receiver features hysteresis to greatly improve noise rejection. The UM211 and UM213 feature a low power shutdown mode, which reduces power supply drain to 1 μ A. The UM213 includes two receivers that remain active during shutdown to monitor for signal activity. The drivers maintain the $\pm 5V$ EIA/TIA-232E output signal levels at data rates in excess of 250kbps when loaded in accordance with the EIA/TIA-232E specification. Driver output and receiver input pins are protected against ESD to over $\pm 15kV$ for both human body mode and IEC61000-4-2 air discharge mode.

The UM207/208 series are available in SOP24, SSOP24 and TSSOP24 packages, the UM211/213 are available in SOP28, SSOP28 and TSSOP28 packages.

Applications

- Computer-Portable, Mainframe, Laptop
- Handheld Equipments
- Battery-Powered Equipments
- Instrumentation, UPS
- Printers and Terminals

Features

- Meets All EIA/TIA-232 and ITU V.28 Specifications
- Single +5V Supply Operation
- 4 \times 0.1 μ F External Charge Pump Capacitors
- Typical 250kbps Transmission Rate
- 1mA Typical Static Supply Current
- 1 μ A Shutdown Mode (UM211/213)
- Two Wake-Up Receivers (UM213)
- Tri-State/Rx Enable (UM211/213)
- Enhanced ESD Specifications for RS-232 Pins:
 - ±15kV Human Body Mode
 - ±15kV IEC61000-4-2 Air Discharge Mode
 - ±8kV IEC61000-4-2 Contact Discharge Mode
- Available in SOP24, SSOP24, TSSOP24, SOP28, SSOP28, TSSOP28 Packages

Selection Table

Part Number	Supply Voltage	Number of Drivers	Number of 232 Receivers	Low Power Shutdown	Number of Receivers Active in Shutdown
UM207EEXX	5V	5	3	NO	0
UM208EEXX	5V	4	4	NO	0
UM211EEXX	5V	4	5	YES	0
UM213EEXX	5V	4	5	YES	2

Ordering Information

Part Number	Temp. Range	Package Type	Shipping Qty
UM207EESO	-40°C to +85°C	SOP24	30pcs/Tube
UM207EEAO	-40°C to +85°C	SSOP24	60pcs/Tube
UM207EEAOR	-40°C to +85°C	SSOP24	2000pcs/13Inch Tape & Reel
UM207EEUO	-40°C to +85°C	TSSOP24	3000pcs/13Inch Tape & Reel
UM208EESO	-40°C to +85°C	SOP24	30pcs/Tube
UM208EEAO	-40°C to +85°C	SSOP24	60pcs/Tube
UM208EEAOR	-40°C to +85°C	SSOP24	2000pcs/13Inch Tape & Reel
UM208EEUO	40°C to +85°C	TSSOP24	3000pcs/13Inch Tape & Reel
UM211EESS	-40°C to +85°C	SOP28	25pcs/Tube
UM211EEAS	-40°C to +85°C	SSOP28	48pcs/Tube
UM211EEASR	-40°C to +85°C	SSOP28	2000pcs/13Inch Tape & Reel
UM211EEUS	40°C to +85°C	TSSOP28	3000pcs/13Inch Tape & Reel
UM213EESS	-40°C to +85°C	SOP28	25pcs/Tube
UM213EEAS	-40°C to +85°C	SSOP28	48pcs/Tube
UM213EEASR	-40°C to +85°C	SSOP28	2000pcs/13Inch Tape & Reel
UM213EEUS	40°C to +85°C	TSSOP28	3000pcs/13Inch Tape & Reel

Absolute Maximum Ratings (Note 1)

Symbol	Parameter	Value	Unit	
V _{CC}	Supply Voltage on V _{CC}	-0.3 to +6	V	
V ₊	Voltage on V ₊	(V _{CC} -0.3) to +9	V	
V ₋	Voltage on V ₋	-9 to +0.3	V	
	Voltage on TIN ₋	-0.3 to (V _{CC} +0.3)	V	
	Voltage on RIN ₋	±30	V	
	Voltage on TOUT ₋	(V ₋ -0.3) to (V ₊ +0.3)	V	
	Voltage on ROUT ₋	-0.3 to (V _{CC} +0.3)	V	
	Short-Circuit Duration, TOUT ₋ to GND	Continuous		
P _D	Continuous Power Dissipation at T _A =70°C	SOP24	941	mW
		SSOP24	640	
		TSSOP24	879	
		SOP28	1000	
		SSOP28	762	
		TSSOP28	1026	
T _A	Operating Temperature Range	-40 to +85	°C	
T _{STG}	Storage Temperature Range	-65 to +165	°C	
T _L	Maximum Lead Temperature for Soldering 10 Seconds	+300	°C	

Note 1: Stresses beyond those listed under “Absolute Maximum Ratings” may cause permanent damage to the device. These are stress ratings only, and functional operation of the device at these or any other conditions beyond those indicated in the operational sections of the specifications is not implied. Exposure to absolute maximum rating conditions for extended periods may affect device reliability.

Electrical Characteristics

($V_{CC}=+5.0V \pm 10\%$, $C1-C4=0.1\mu F$, $T_A=T_{MIN}$ to T_{MAX} , unless otherwise noted. Typical values are at $T_A=25^\circ C$)

Parameter	Conditions	Min	Typ	Max	Unit	
Output Voltage Swing	All transmitter outputs loaded with 3k Ω to ground	± 5	± 6		V	
V_{CC} Power Supply Current	No load		0.6	1	mA	
Shutdown Supply Current	UM211		0.1	10	μA	
	UM213		0.1	50		
Input Logic Threshold Low	$T_{IN}, \overline{EN}, \overline{SHDN}, \overline{EN}, \overline{SHDN}$			0.8	V	
Input Logic Threshold High	$T_{IN}, \overline{EN}, \overline{SHDN}, \overline{EN}, \overline{SHDN}$	2.4				
RS-232 Input Voltage Operating Range		-30		+30	V	
Receiver Input Threshold Low	$V_{CC}=+5V$ $T_A=25^\circ C$	Active Mode	0.8	1.2	V	
		Shut down Mode	0.6	1.5		
Receiver Input Threshold High	$V_{CC}=+5V$ $T_A=25^\circ C$	Active Mode		1.7	2.4	V
		Shut down Mode		1.5	2.4	
Input Hysteresis	$V_{CC}=+5V$, no hysteresis in shutdown	0.2	0.5	1.0	V	
Input Resistance	$V_{CC}=+5V$, $T_A=25^\circ C$	3	5	7	k Ω	
TTL/CMOS Output Voltage Low	$I_{OUT}=1.6mA$			0.4	V	
TTL/CMOS Output Voltage High	$I_{OUT}=1.0mA$	3.5			V	
TTL/CMOS Output Leakage Current	$\overline{EN}=V_{CC}, EN=0V, 0 \leq R_{OUT} \leq V_{CC}$		± 0.05	± 10	μA	
Output Enable Time	UM211/213		600		ns	
Output Disable Time	UM211/213		200		ns	
Receiver Propagation Delay	$\overline{SHDN}=0V$	UM213		4	40	μs
	$\overline{SHDN}=V_{CC}$			0.5	10	
	UM207/208/211			0.5	10	
Transmitter Output Resistance	$V_{CC}=V+=V-=0V, V_{OUT}=\pm 2V$	300			Ω	
Transition Region Slew Rate	$C_L=50pF$ to 2500pF, $R_L=3k\Omega$ to 7k Ω , $V_{CC}=+5V, T_A=25^\circ C$, measured from +3V to -3V or -3V to +3V	3	5.5	30	V/ μs	
RS-232 Output Short Circuit Current			± 10	± 30	mA	
Maximum Data Rate	$R_L=3k\Omega$ to 7k $\Omega, C_L=50pF$ to 1000pF, one transmitter	120	250		kbps	

Pin Configurations

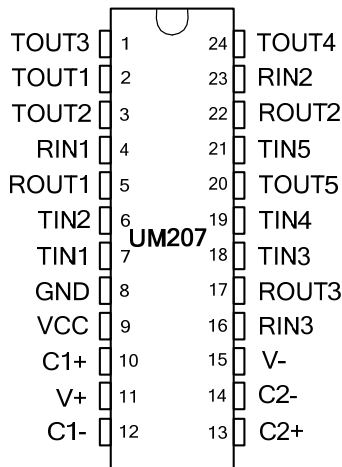

SOP24/SSOP24/TSSOP24

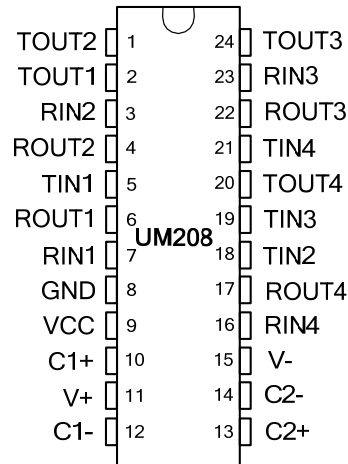

SOP24/SSOP24/TSSOP24

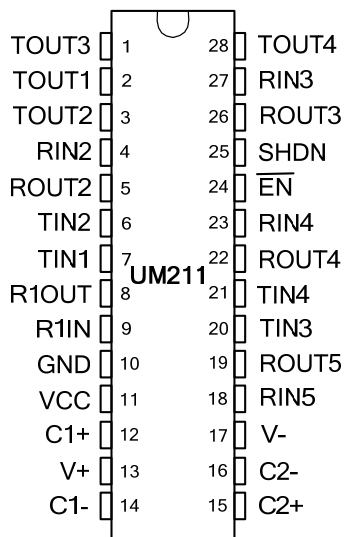

SOP28/SSOP28/TSSOP28

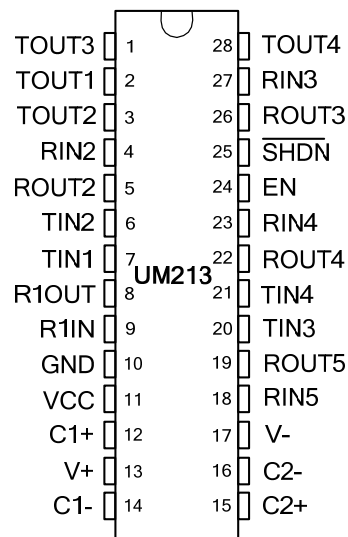

SOP28/SSOP28/TSSOP28

Pin Descriptions

Pin Name	Function
C1+, C2+	Terminals for Positive Charge Pump Capacitor
V+	Charge Pump Output Regulated to +6.5V
C1-C2-	Terminals for Negative Charge Pump Capacitor
V-	Charge Pump Output Regulated to -6.5V
TOUT	RS-232 Driver Outputs
RIN	RS-232 Receiver Inputs
ROUT	RS-232 Receiver Outputs
TIN	RS-232 Driver Inputs
GND	Ground
V _{CC}	+4.5V to +5.5V Supply Voltage Input
EN, EN	Receiver Enable
SHDN, SHDN	Transmitters Shutdown

UM211 Control Pin Configurations

SHDN	EN	Operation Status	Transmitters T1-T5	Receivers R1-R5
0	0	Normal Operation	All Active	All Active
0	1	Normal Operation	All Active	All High-Z
1	0	Shutdown	All High-Z	All High-Z

UM213 Control Pin Configurations

SHDN	EN	Operation Status	Transmitters T1-T4	Receivers	
				R1,R2,R3	R4,R5
0	0	Shutdown	All High-Z	High-Z	High-Z
0	1	Shutdown	All High-Z	High-Z	Active
1	0	Normal Operation	All Active	High-Z	High-Z
1	1	Normal Operation	All Active	Active	Active

Active=active with reduced performance

Detailed Description

The UM207/208/211/213 consists of three sections: charge-pump voltage converters, drivers, and receivers. These E versions provide extra protection against ESD. They survive $\pm 15\text{kV}$ discharges to the RS-232 inputs and outputs, tested using the Human Body Model. When tested according to IEC61000-4-2, they survive $\pm 8\text{kV}$ contact-discharges and $\pm 15\text{kV}$ air-gap discharges. The rugged E versions are intended for use in harsh environments or applications where the RS-232 connection is frequently changed.

RS-232 Drivers

The drivers are inverting transmitters, which accept TTL or CMOS inputs and output RS-232 signals with an inverted sense relative to the input logic levels. Typically the RS-232 output voltage swing is $\pm 6\text{V}$. Even under worst case loading conditions of $3\text{k}\Omega$ and 2500pF , the output is guaranteed to be $\pm 5\text{V}$, which is consistent with the RS-232 standard specifications. The transmitter outputs are protected against infinite short-circuits to ground without degradation in reliability. The instantaneous slew rate of the transmitter output is internally limited to a maximum of $30\text{V}/\mu\text{s}$ in order to meet the RS-232 standard. The smooth transition of the loaded output from V_{OL} to V_{OH} clearly meets the monotonicity requirements of the RS-232 standard.

RS-232 Receivers

The receivers convert RS-232 input signals to inverted TTL signals. The input thresholds are 0.8V minimum and 2.4V maximum, again well within the 3V RS-232 requirements. The receiver inputs are also protected against voltage up to 30V . A $5\text{k}\Omega$ pull down resistor to ground will commit the output of the receiver to a high state when the pin is float. In actual system applications, it is quite possible for signals to be applied to the receiver inputs before power is applied the receiver circuitry. This occurs, for example, when a PC user attempts to print, only to realize the printer wasn't turned on. In this case an RS-232 signal from the PC will appear on the receiver input at the printer. When the printer power is turned on, the receiver will operate normally. All of these enhanced devices are fully protected.

Shutdown and Enable Control

In shutdown mode, the UM211/213 charge pumps are turned off, $V+$ is pulled down to V_{CC} , $V-$ is pulled to ground, and the transmitter outputs are disabled. This reduces supply current typically to $1\mu\text{A}$. The time required to exit shutdown is 1ms .

All receivers except R4 and R5 on the UM213 are put into a high-impedance state in shutdown mode. The UM213's R4 and R5 receivers still function in shutdown mode. These two receivers are useful for monitoring external activity while maintaining minimal power consumption.

The enable control is used to put the receiver outputs into a high-impedance state, so that the receivers can be connected directly to a three-state bus. It has no effect on the RS-232 drivers or on the charge pumps.

UM213 Receiver Operation in Shutdown

During normal operation, the UM213's receiver propagation delay is typically $1\mu\text{s}$. When entering shutdown with receivers active, R4 and R5 are not valid until $80\mu\text{s}$ after $\overline{\text{SHDN}}$ is driven low. In shutdown mode, propagation delays increase to $4\mu\text{s}$ for a high-to-low or a low-to-high transition.

When exiting shutdown, all receiver outputs are invalid until the charge pumps reach nominal values ($< 2\text{ms}$ when using $0.1\mu\text{F}$ capacitors).

ESD Protection

UM207/208/211/213 devices have standard ESD protection structures incorporated on the pins to protect against electrostatic discharges encountered during assembly and handling. In addition, the RS-232 bus pins (driver outputs and receiver input) of these devices have an extra level of ESD protection. Advanced ESD structures were designed to successfully protect these pins against ESD discharge of $\pm 15\text{kV}$ Human Body Model when powered down or up.

Typical Operating Circuits

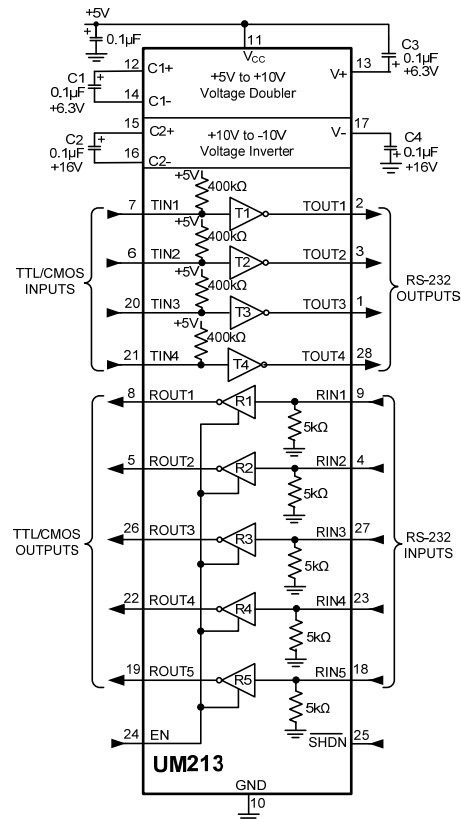
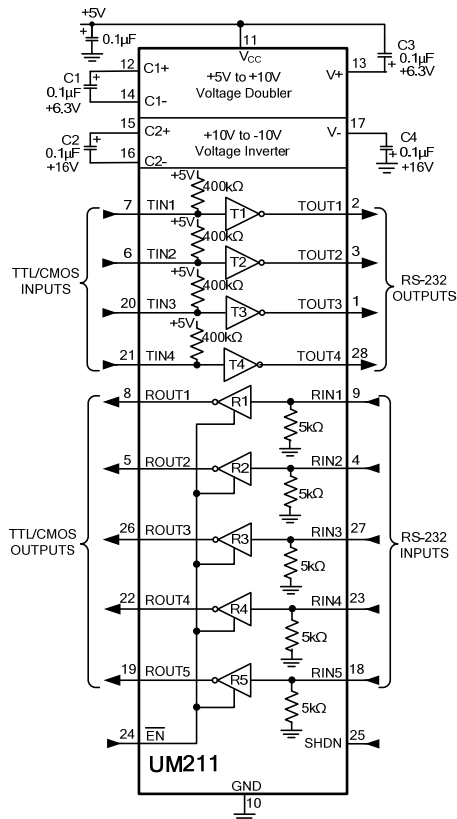
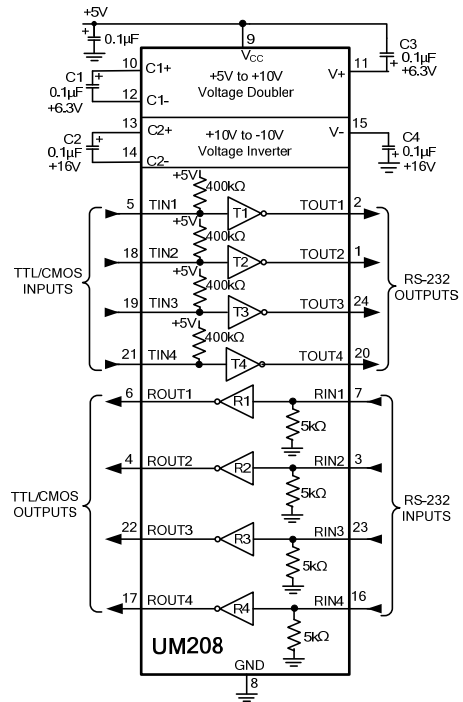
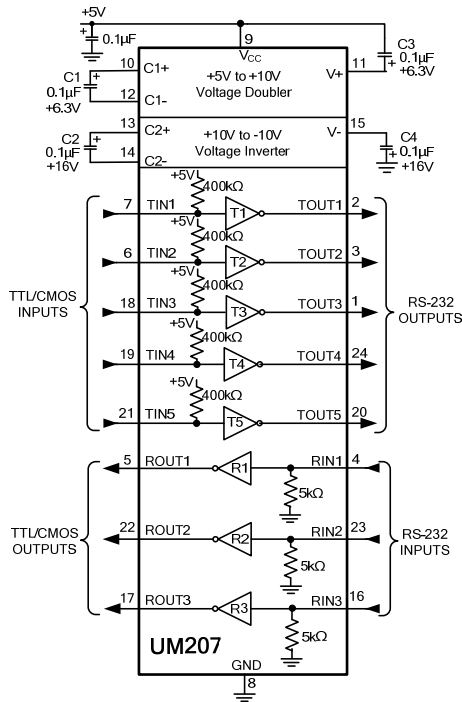

Application Information

Capacitor Selection

The capacitor type used for C1–C4 is not critical for proper operation. The UM207/208/211/213 series require 0.1 μ F capacitors, although in all cases capacitors up to 10 μ F can be used without harm. Ceramic dielectrics are suggested for the 0.1 μ F capacitors. When using the minimum recommended capacitor values, make sure the capacitance value does not degrade excessively as the operating temperature varies. If in doubt, use capacitors with a larger (e.g., 2x) nominal value. The capacitors' effective series resistance (ESR), which usually rises at low temperatures, influences the amount of ripple on V₊ and V₋. Use larger capacitors (up to 10 μ F) to reduce the output impedance at V₊ and V₋. Bypass V_{CC} to ground with at least 0.1 μ F capacitor. In applications sensitive to power-supply noise generated by the charge pumps, decouple V_{CC} to ground with a capacitor the same size as (or larger than) the charge pump capacitors (C1–C4).

V₊ and V₋ as Power Supplies

A small amount of power can be drawn from V₊ and V₋, although this will reduce both driver output swing and noise margins. Increasing the value of the charge-pump capacitors (up to 10 μ F) helps maintain performance when power is drawn from V₊ or V₋.

Driving Multiple Receivers

Each transmitter is designed to drive a single receiver. Transmitters can be paralleled to drive multiple receivers.

Package Information

UM207EESO SOP24

Outline Drawing

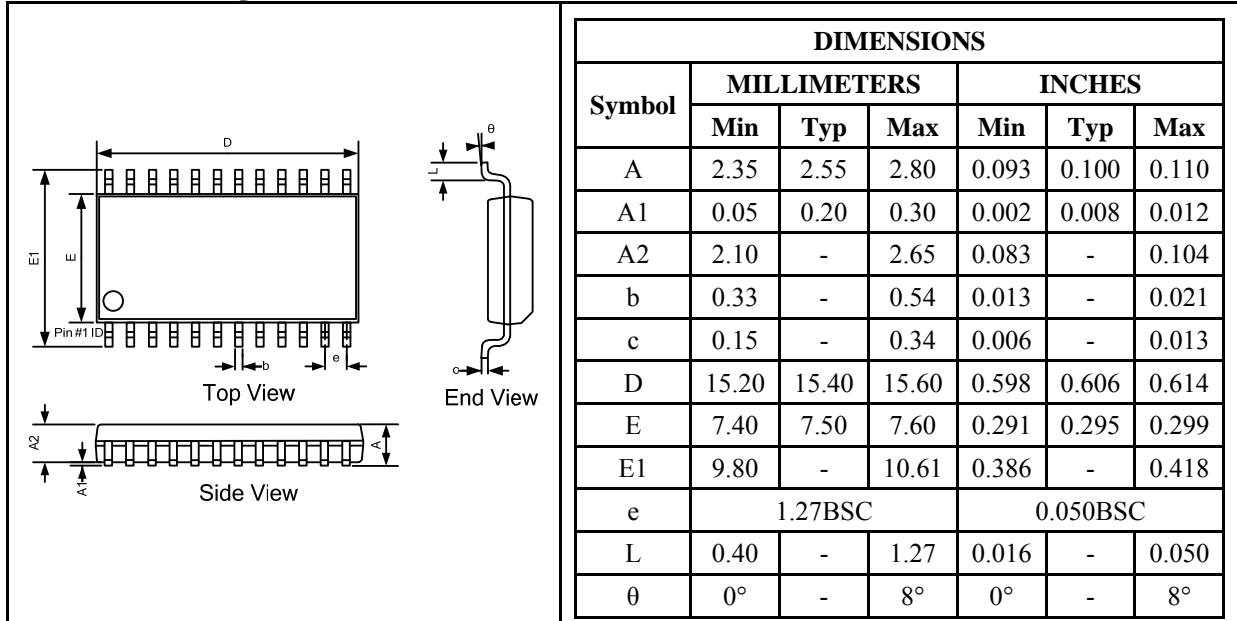

Land Pattern

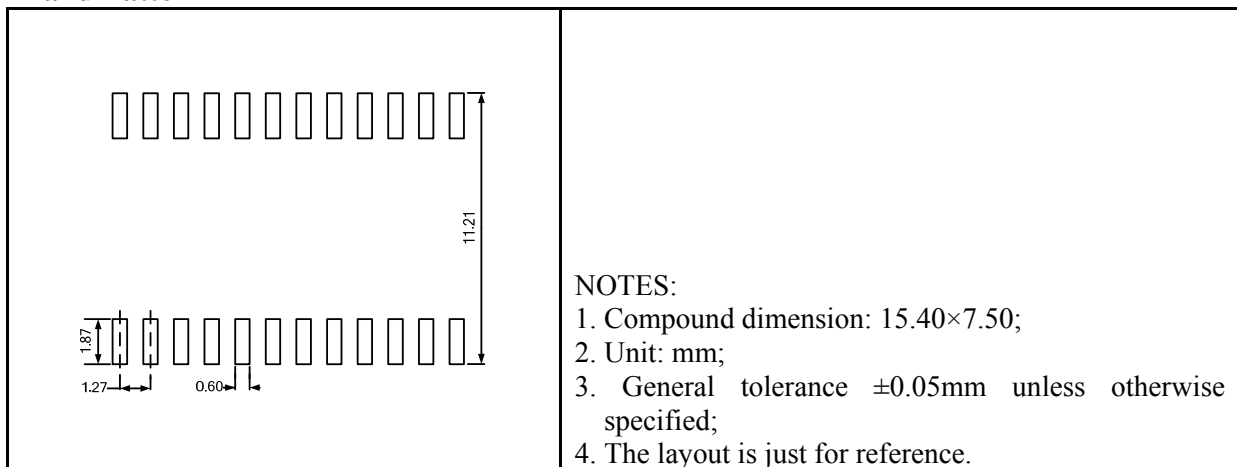

UM207EEAO SSOP24

Outline Drawing

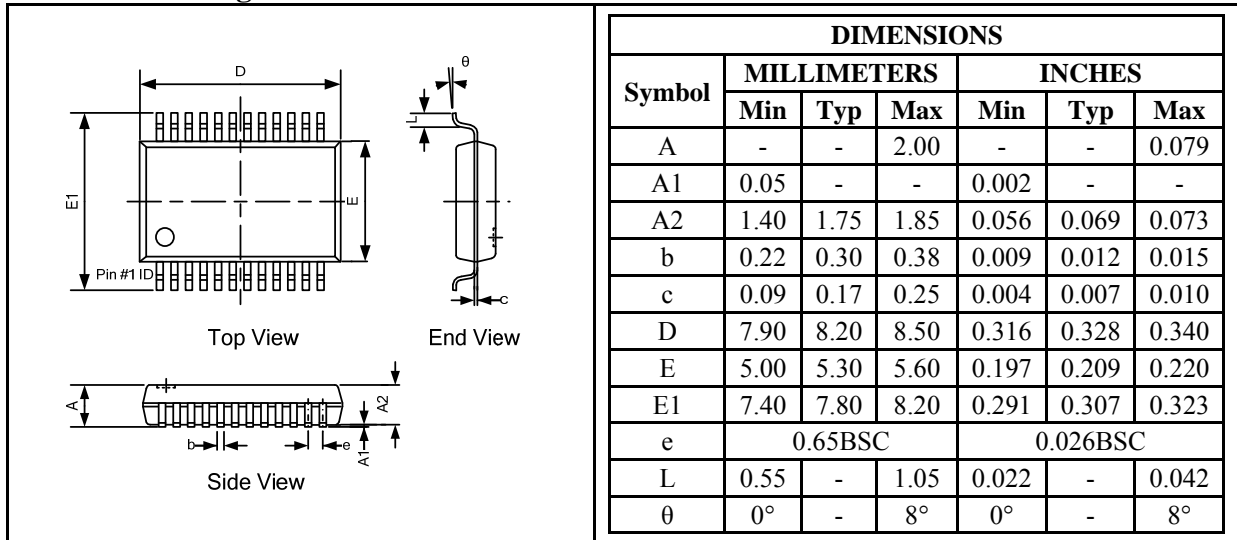

Land Pattern

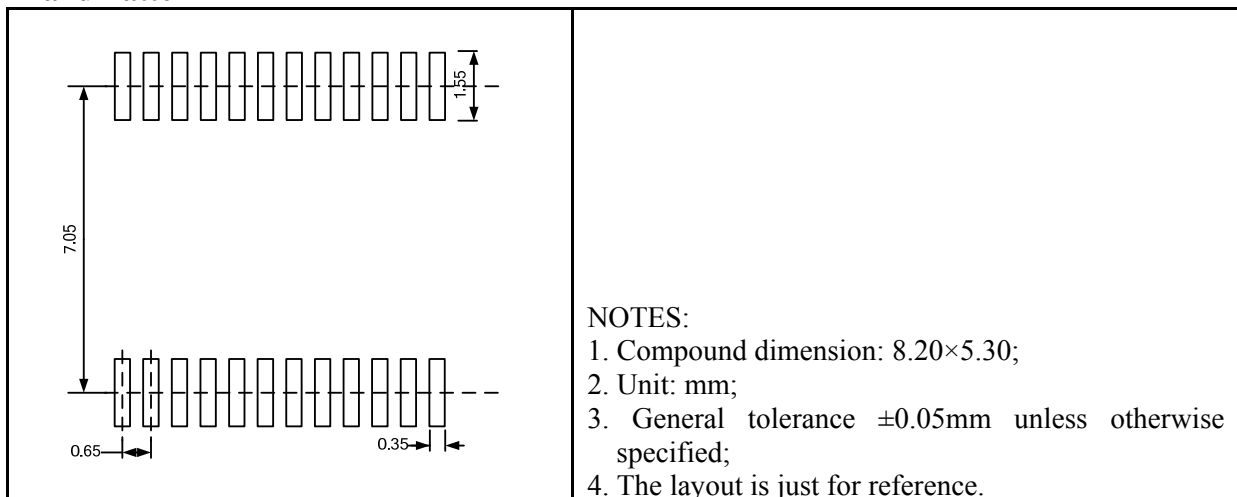

UM207EEAOR SSOP24

Outline Drawing

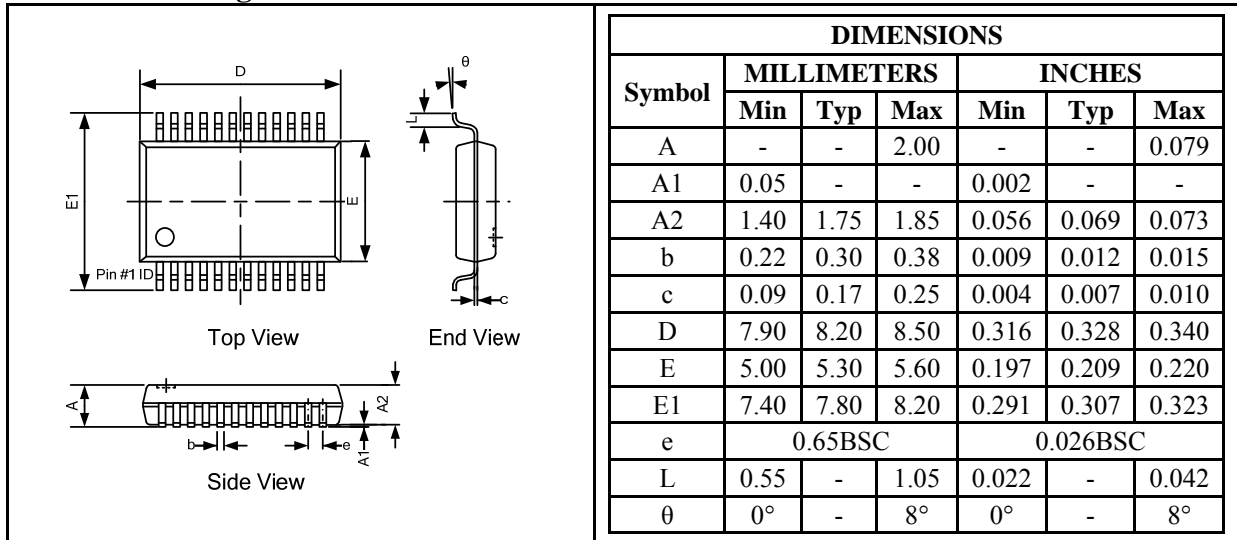

Land Pattern

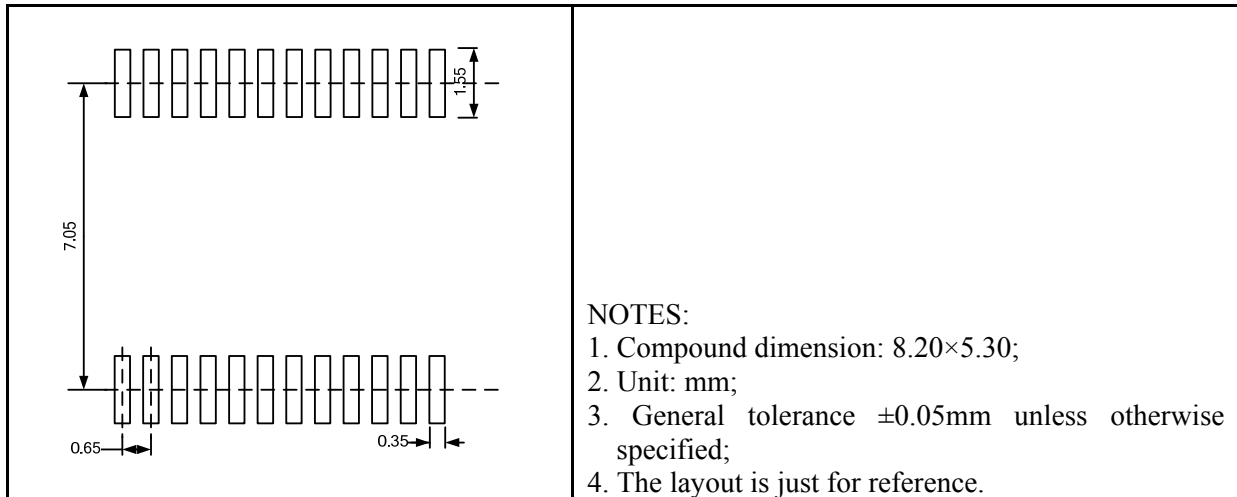

Tape and Reel Orientation



UM207EEUO TSSOP24

Outline Drawing

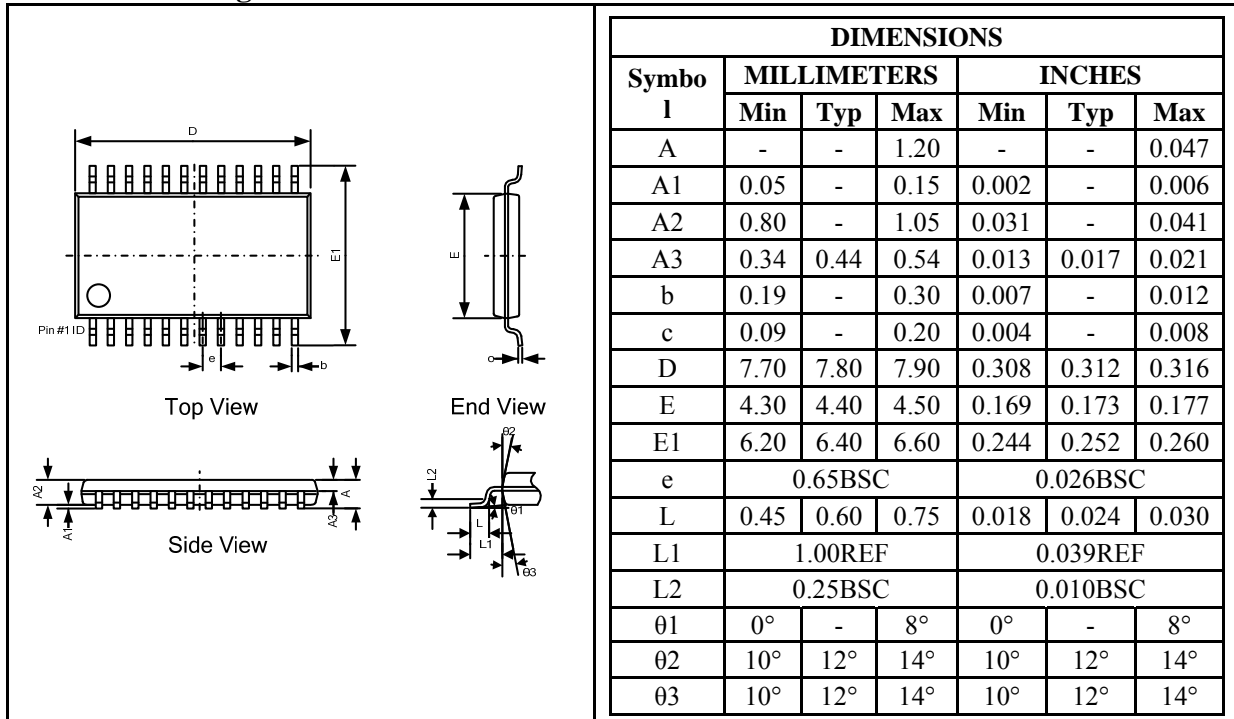

Land Pattern

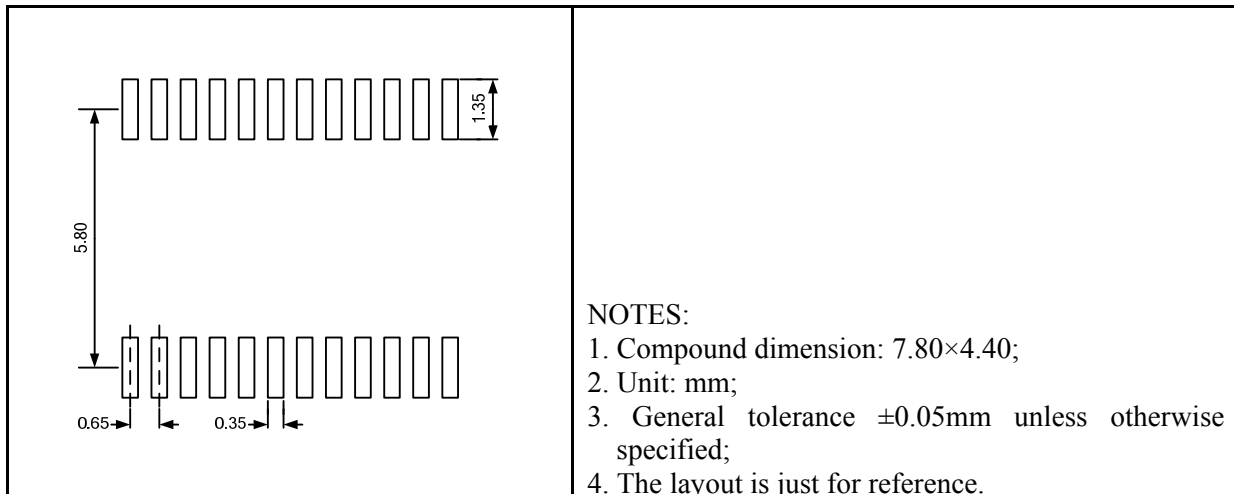

Tape and Reel Orientation



UM208EESO SOP24

Outline Drawing

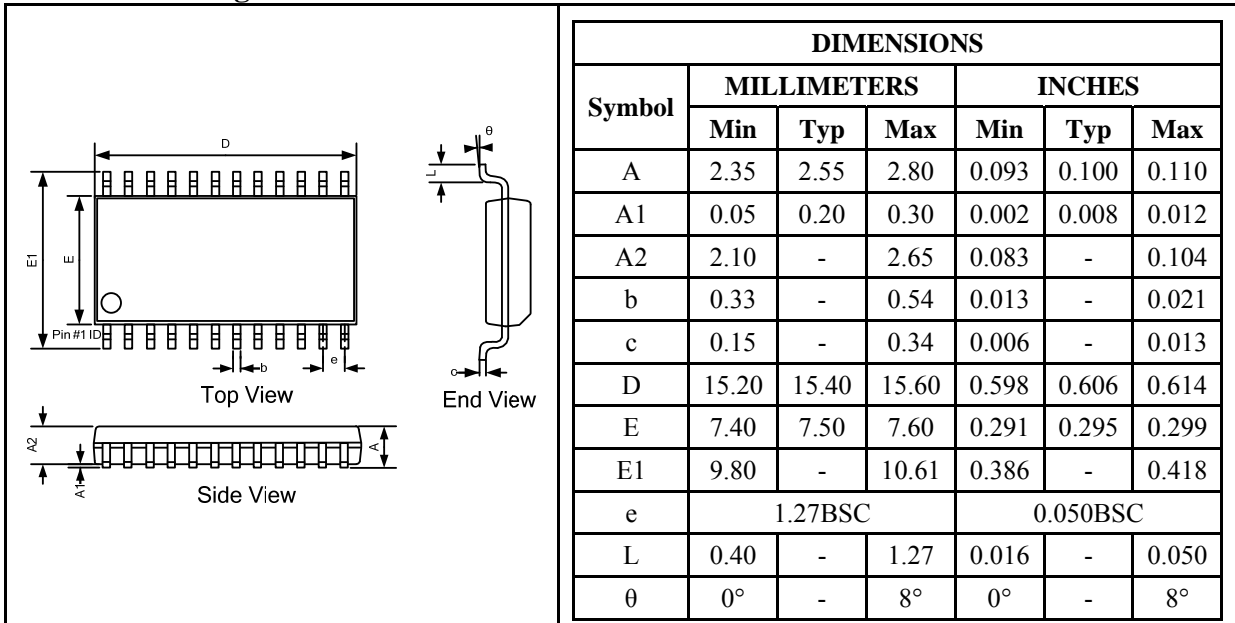

Land Pattern

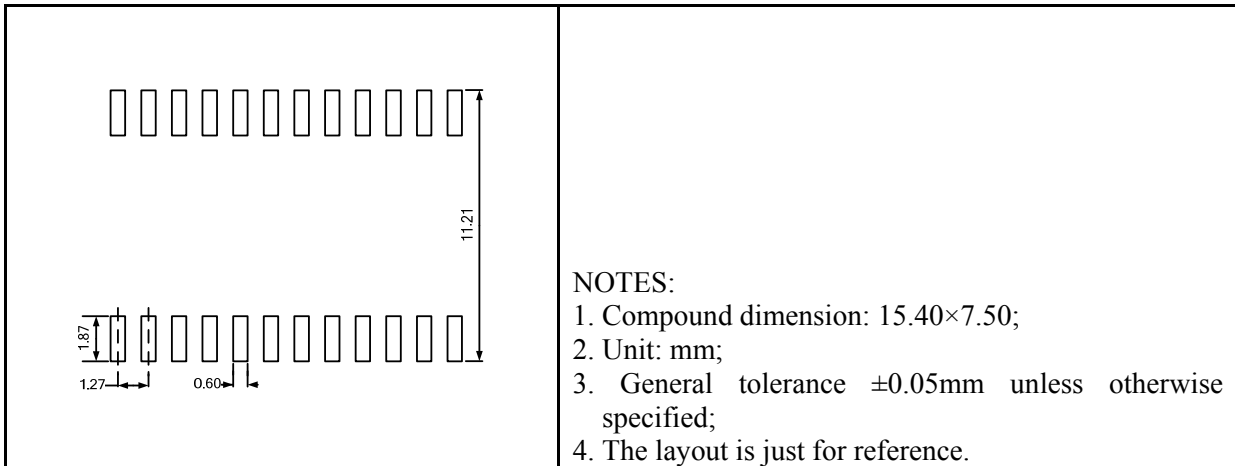

UM208EEAO SSOP24

Outline Drawing

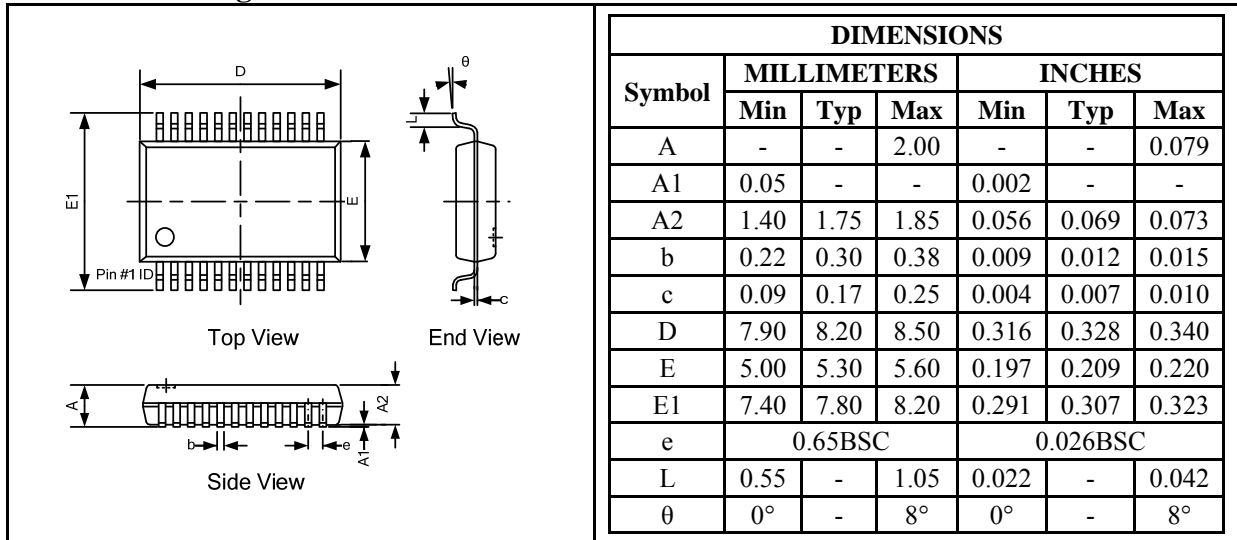

Land Pattern

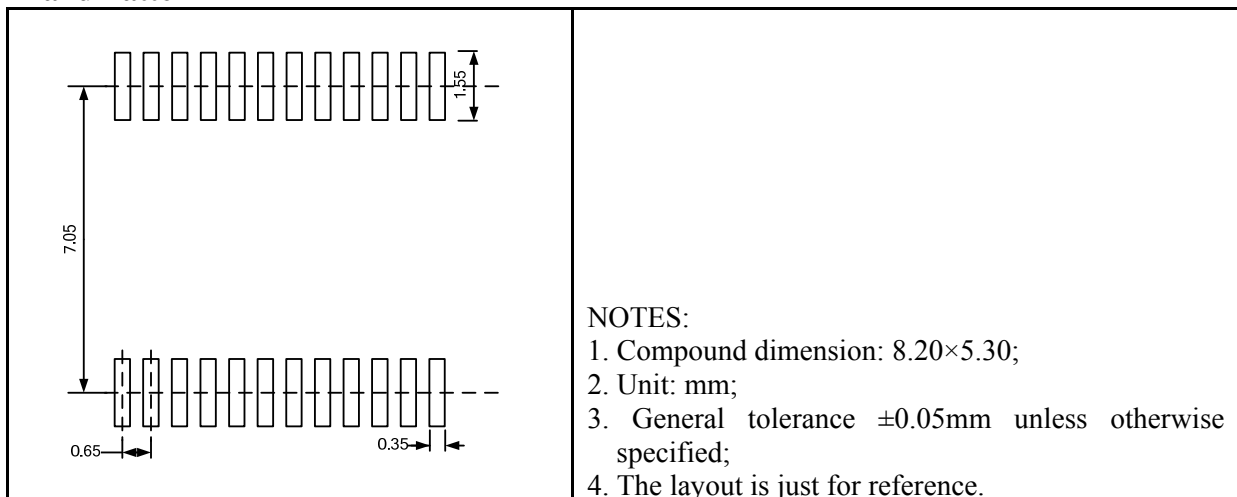

UM208EEAOR SSOP24

Outline Drawing

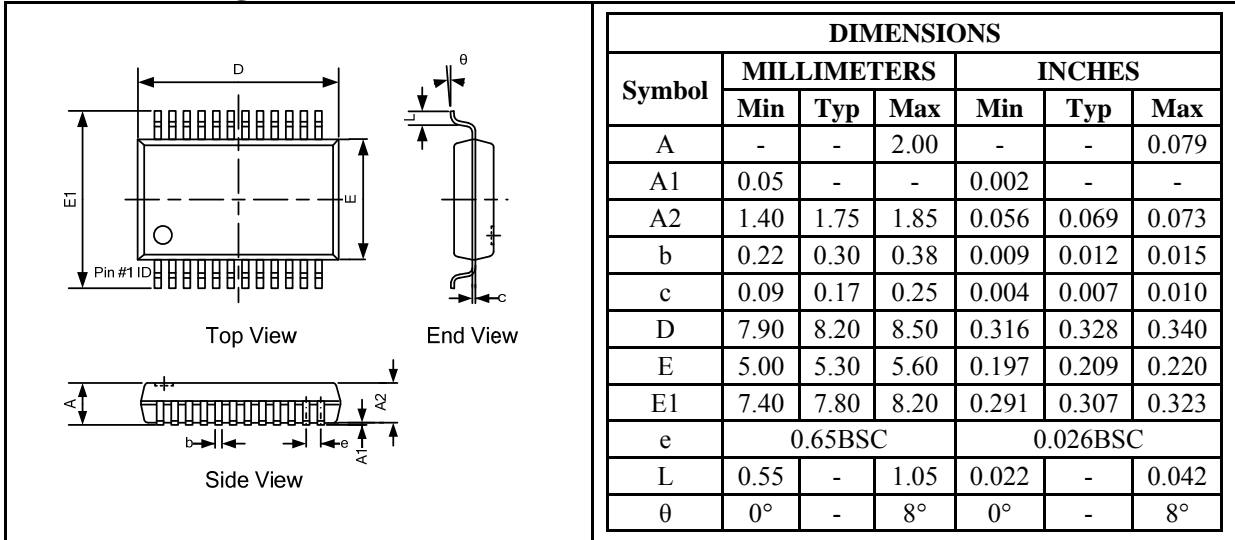

Land Pattern

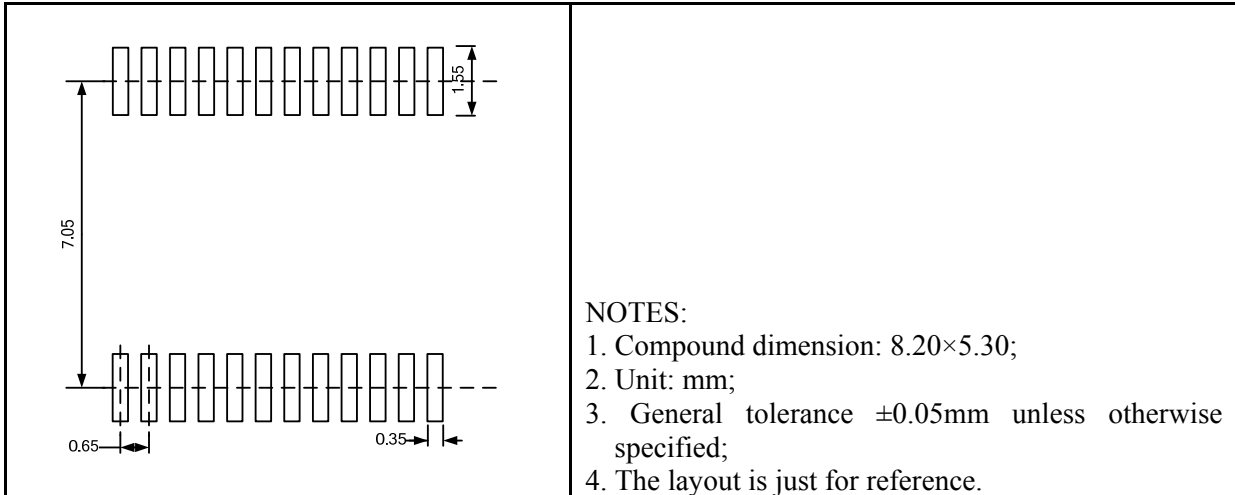

Tape and Reel Orientation



UM208EEUO TSSOP24

Outline Drawing

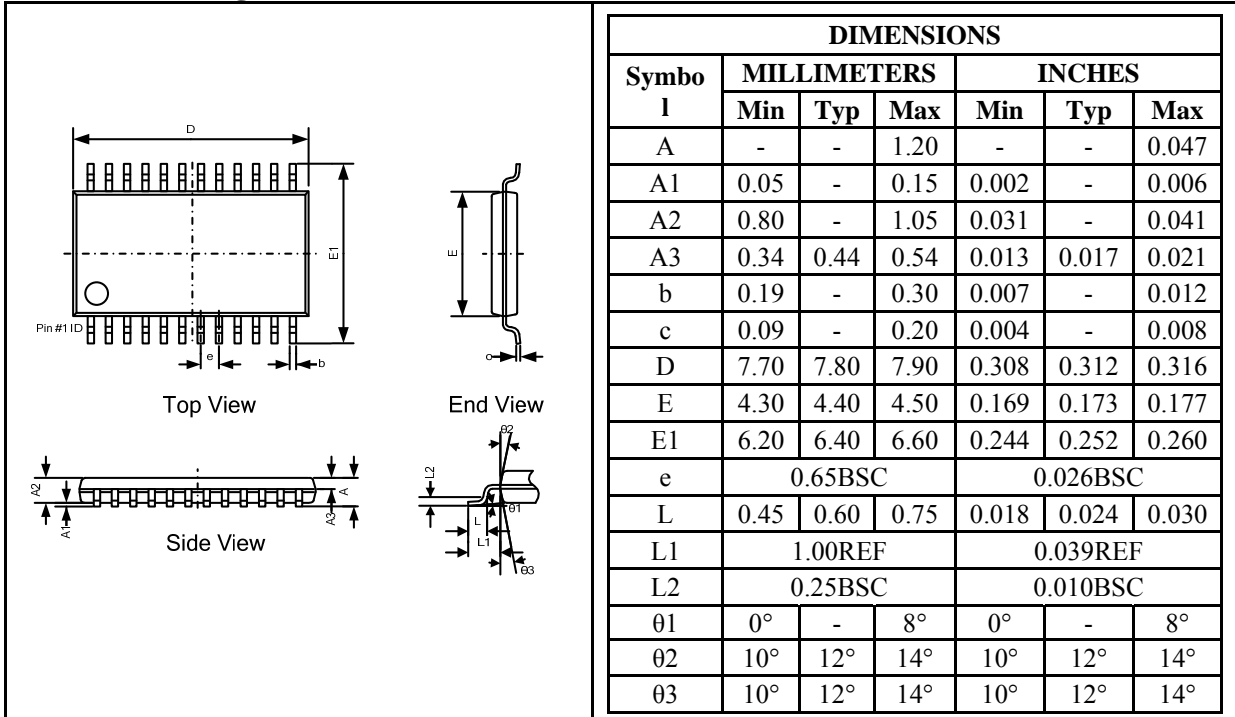

Land Pattern

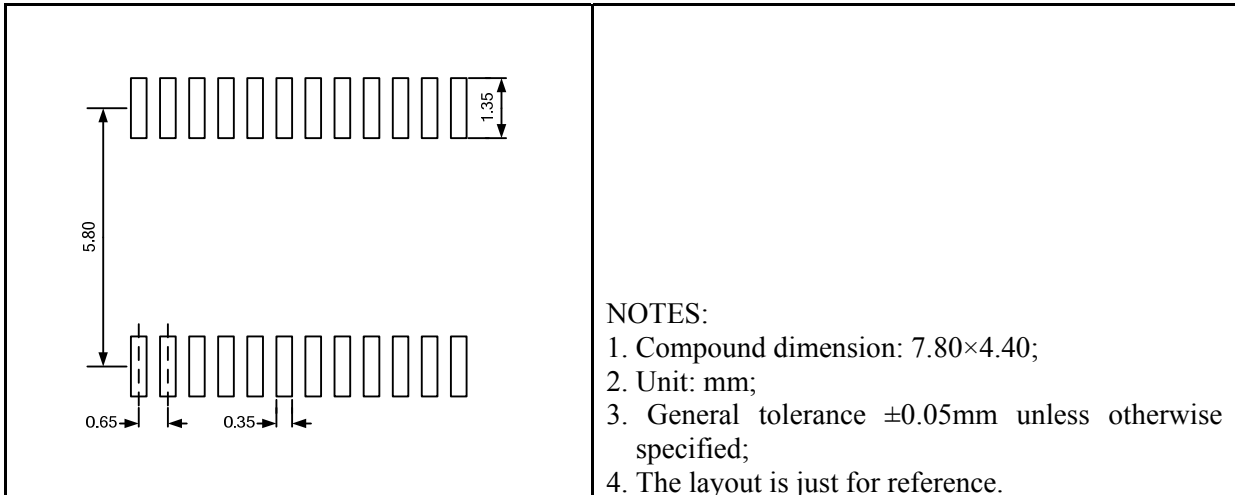

Tape and Reel Orientation

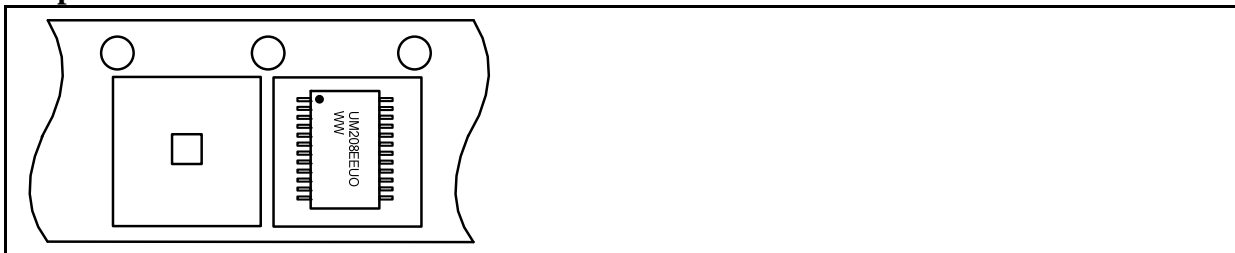

UM211EESS SOP28

Outline Drawing

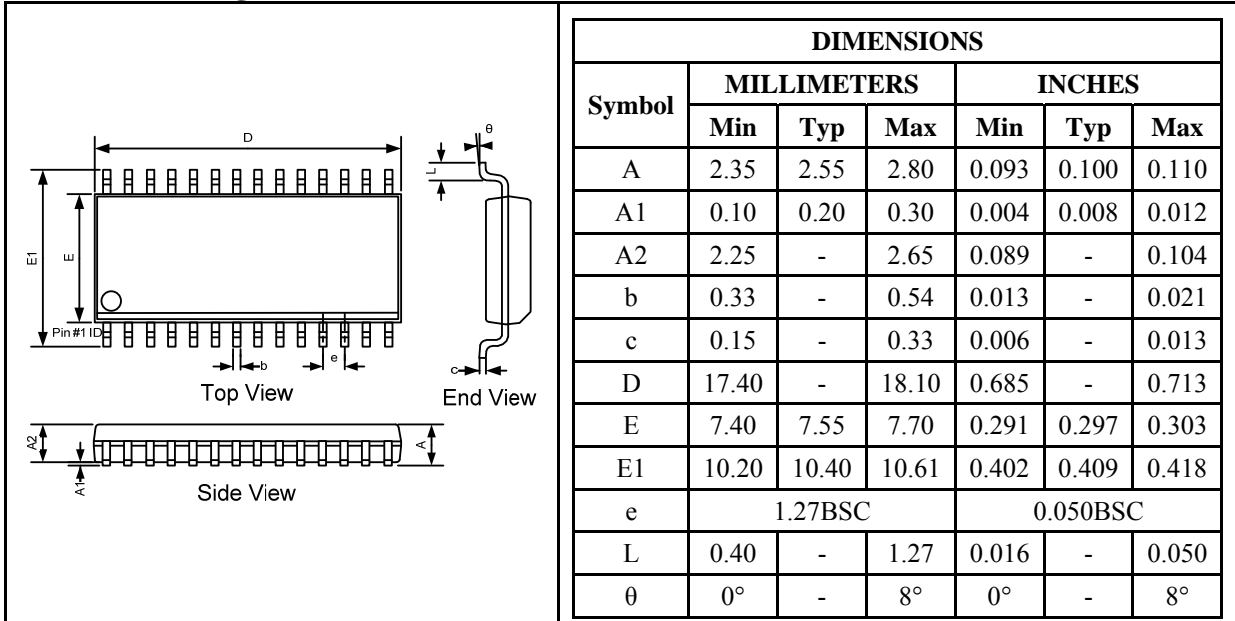

Land Pattern

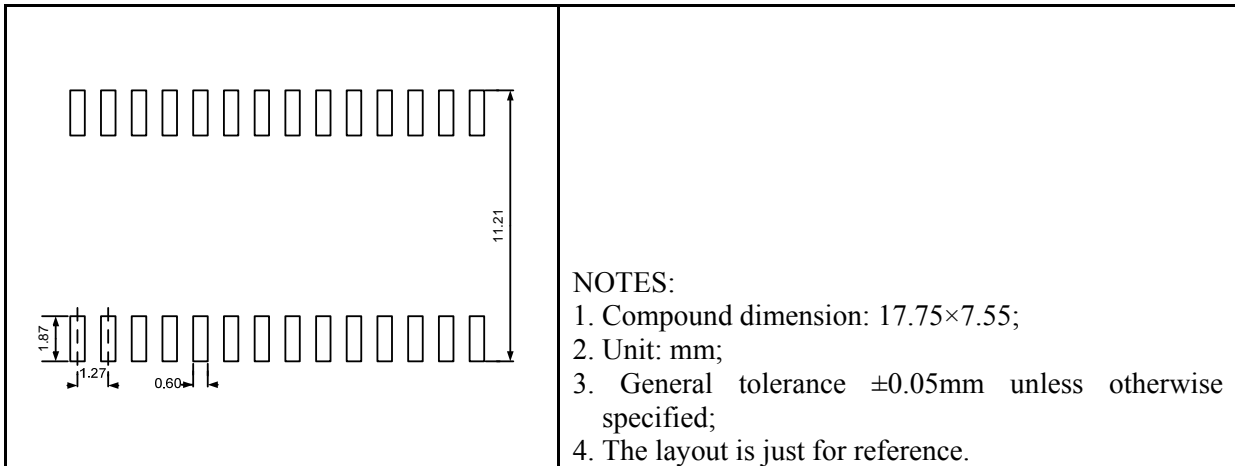

UM211EEAS SSOP28

Outline Drawing

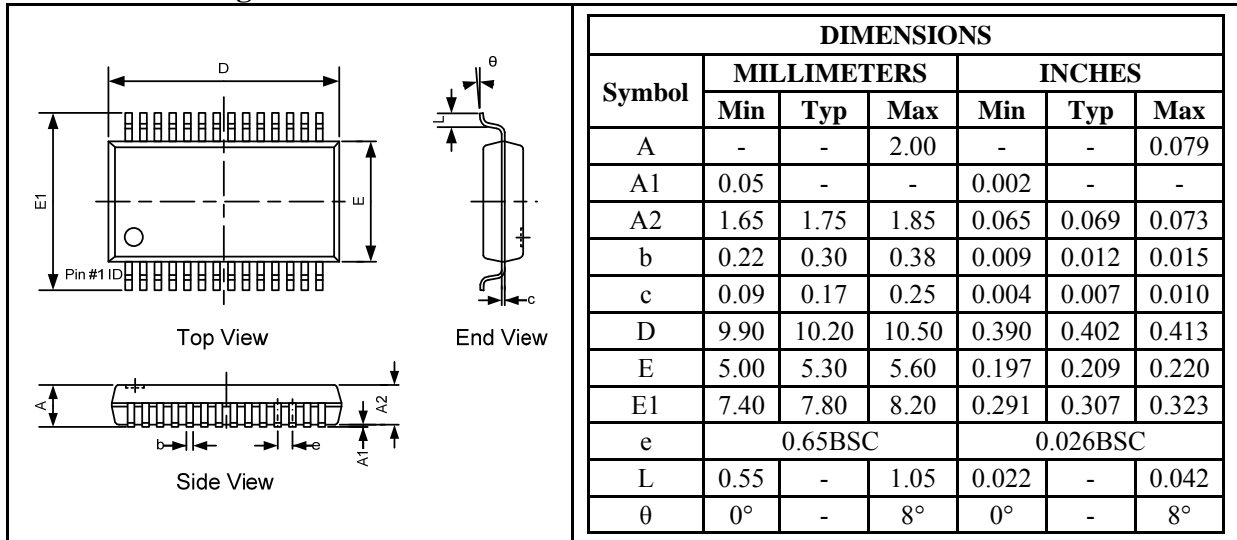

Land Pattern

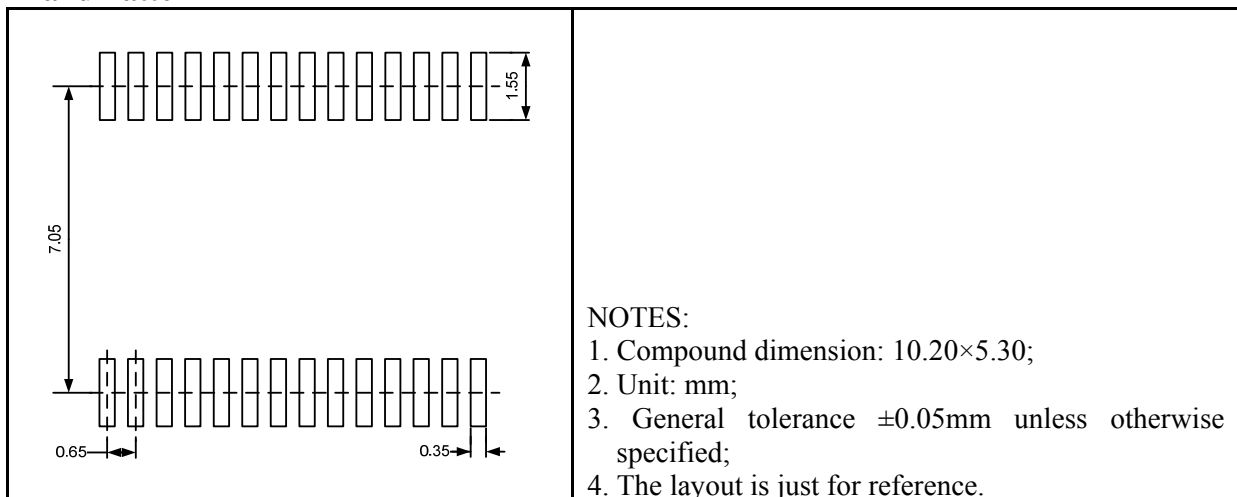

UM211EEASR SSOP28

Outline Drawing

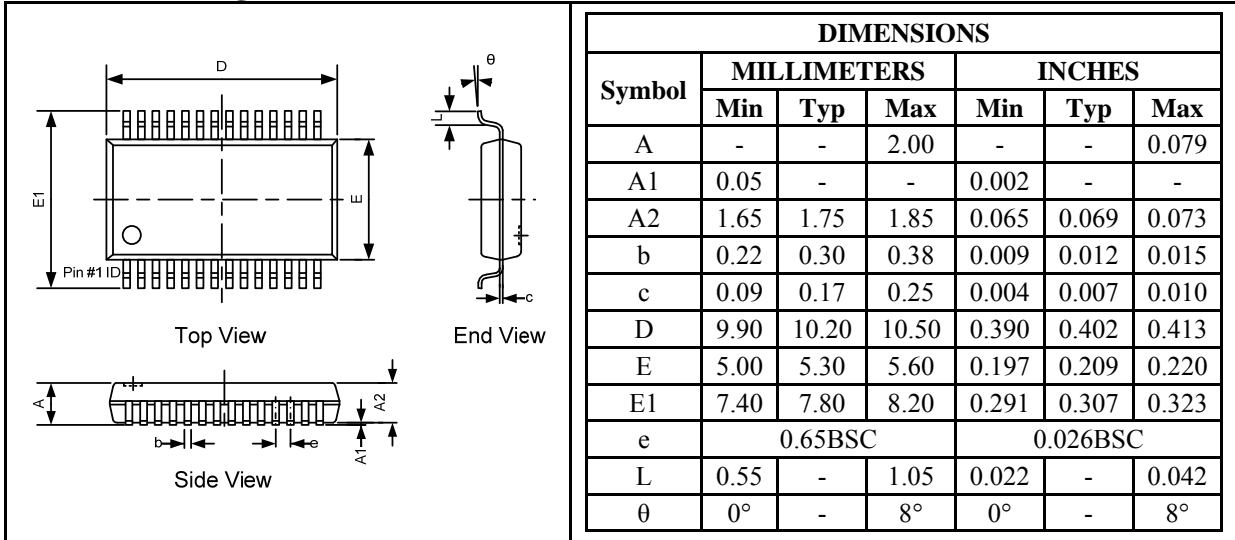

Land Pattern

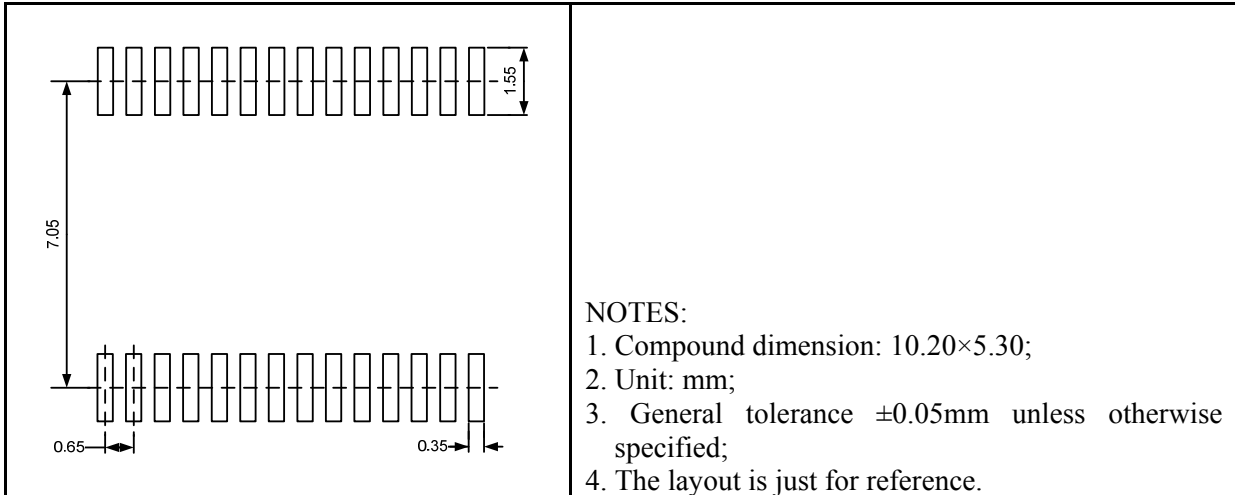

Tape and Reel Orientation



UM211EEUS TSSOP28

Outline Drawing

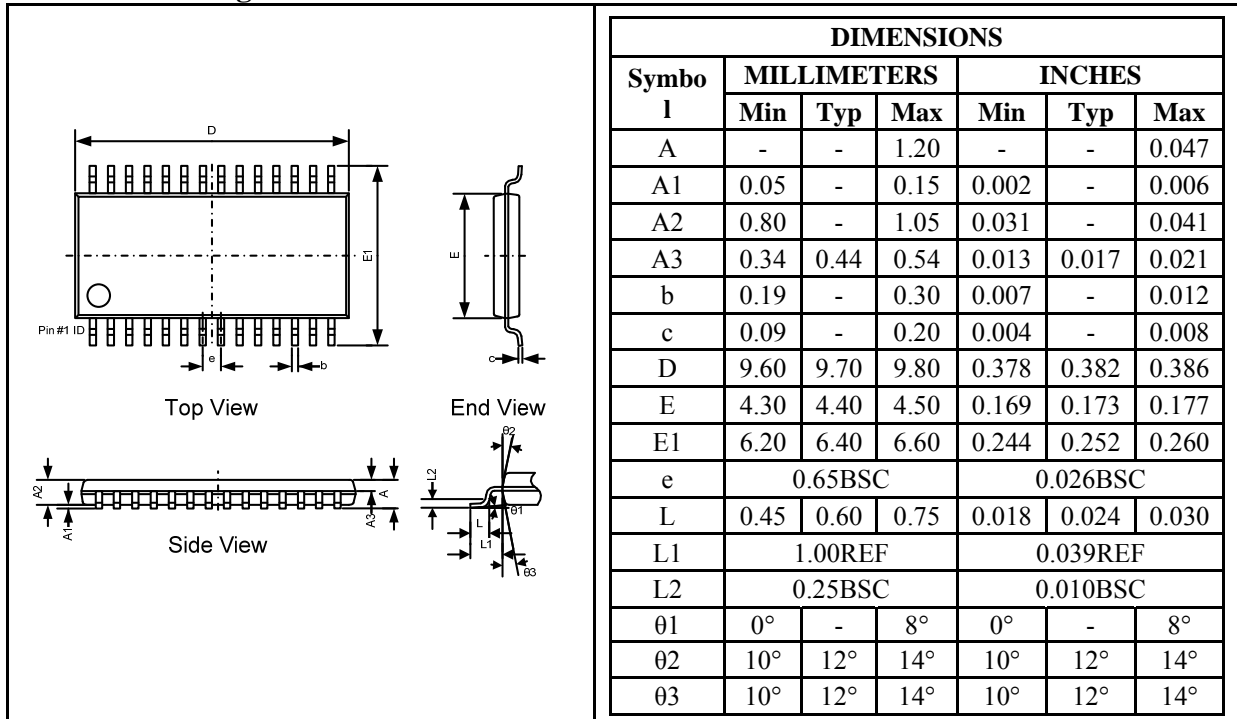

Land Pattern

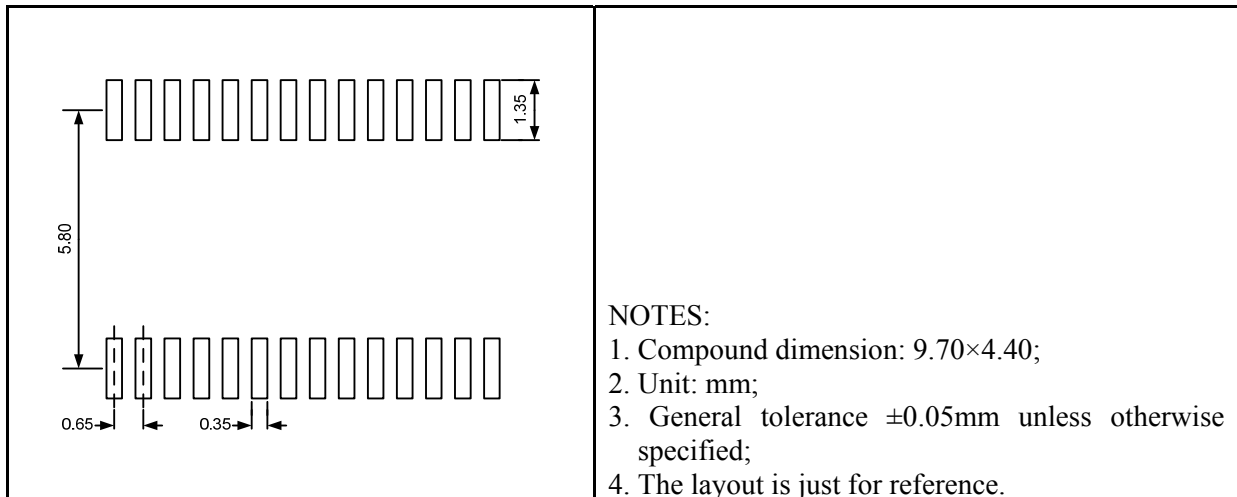

Tape and Reel Orientation

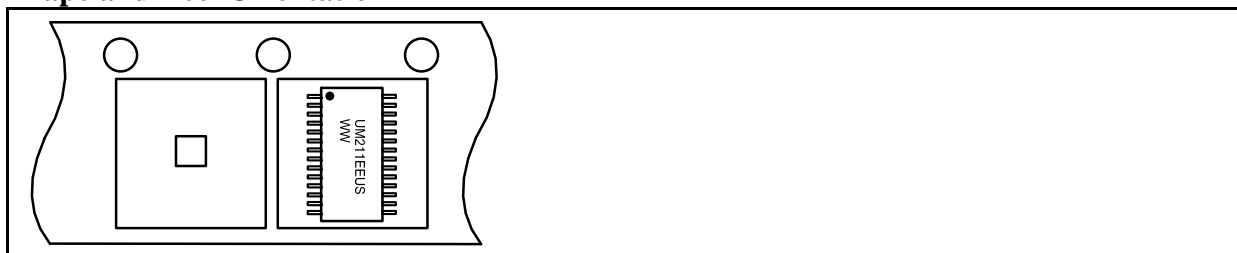

UM213EESS SOP28

Outline Drawing

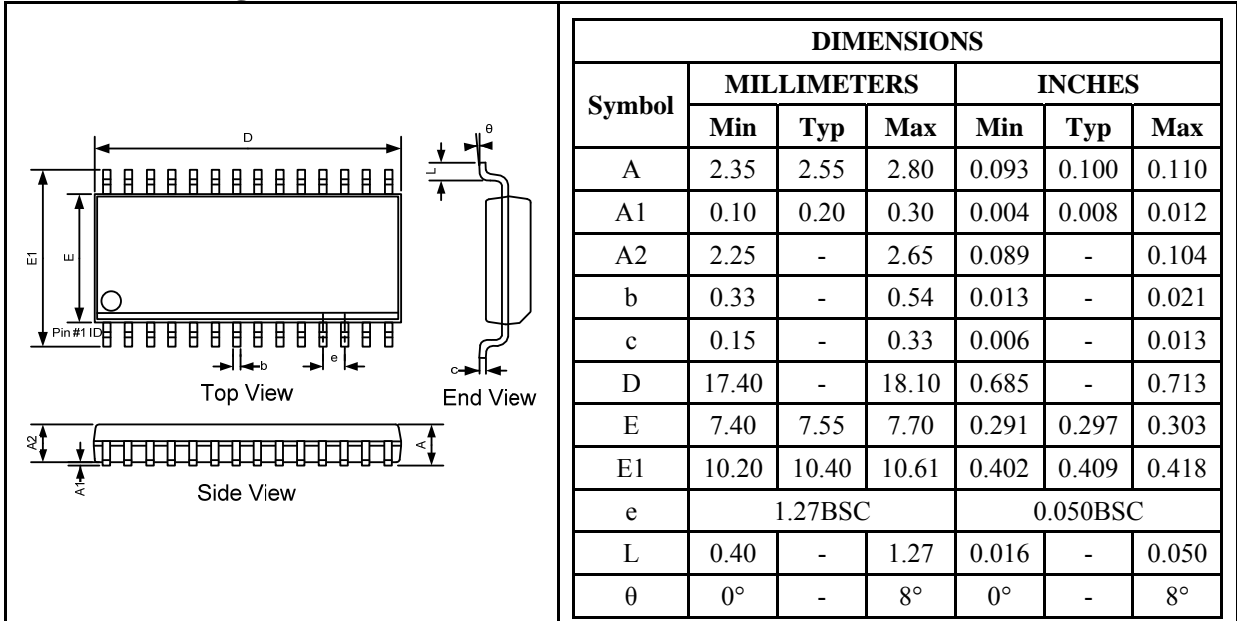

Land Pattern

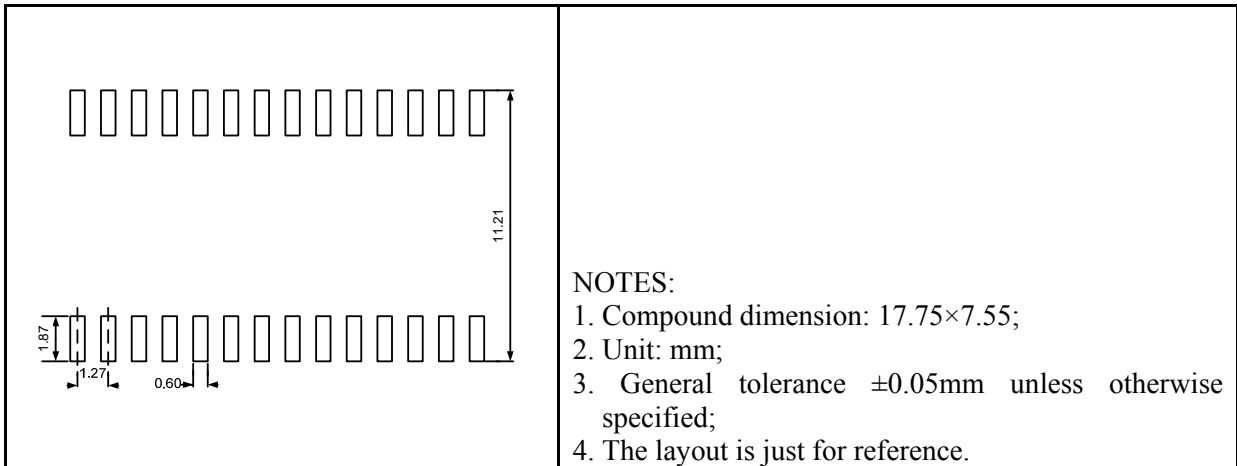

UM213EEAS SSOP28

Outline Drawing

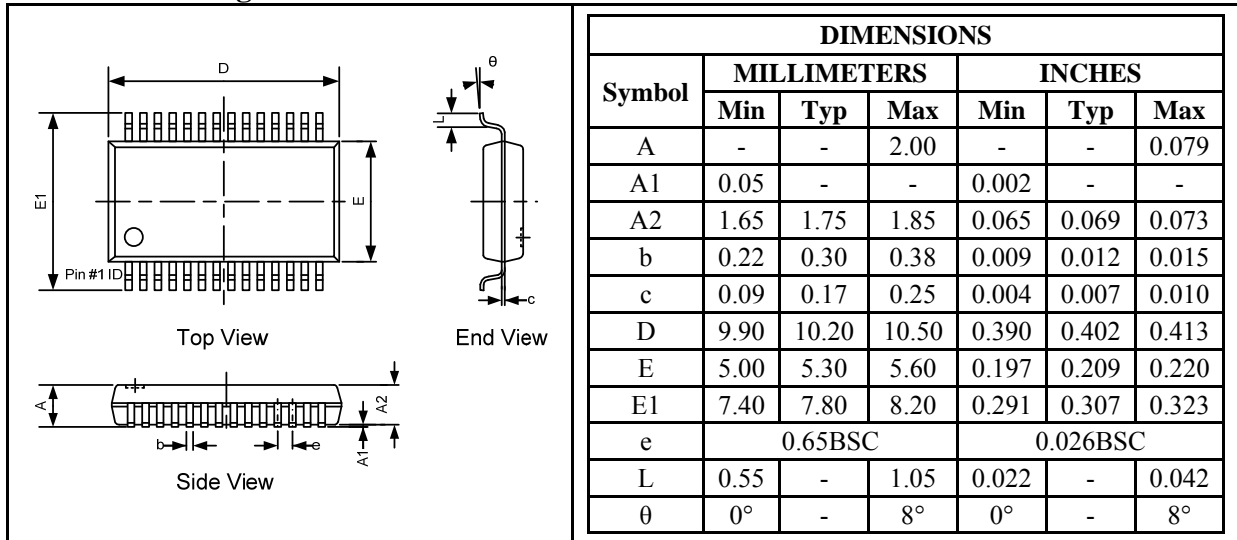

Land Pattern

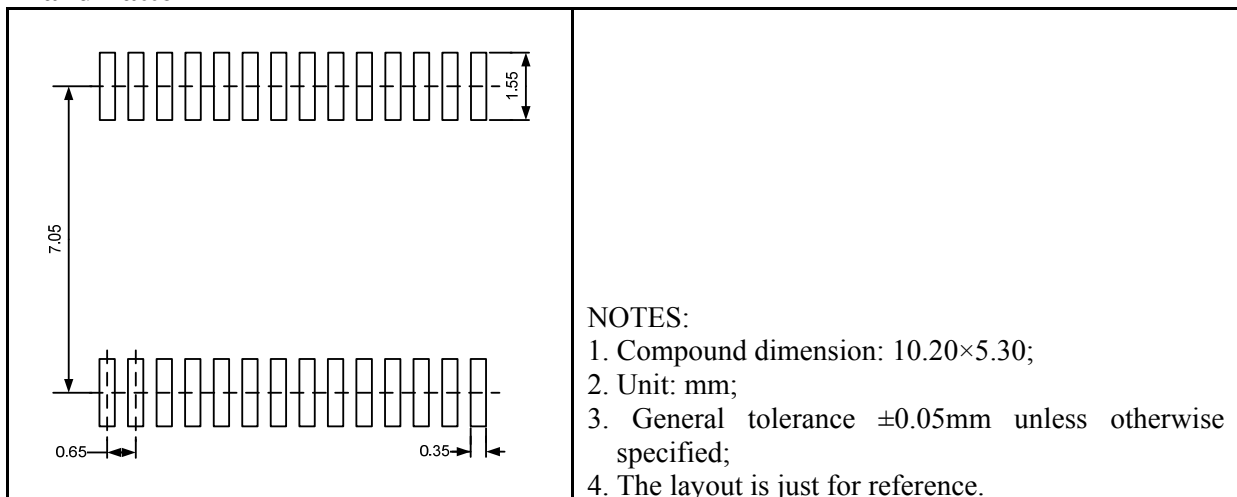

UM213EEASR SSOP28

Outline Drawing

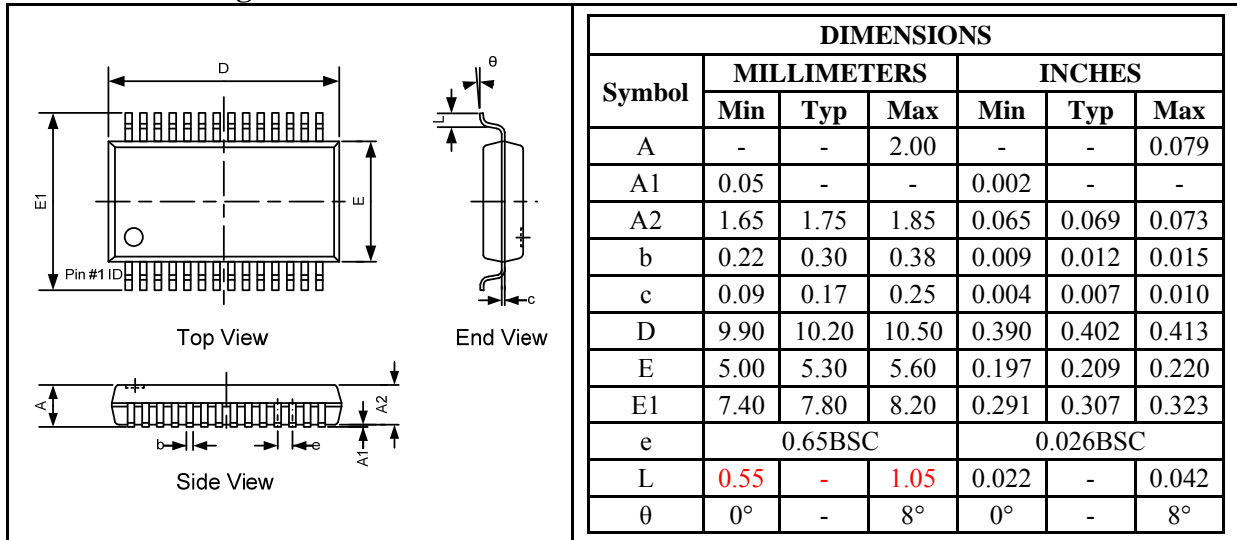

Land Pattern

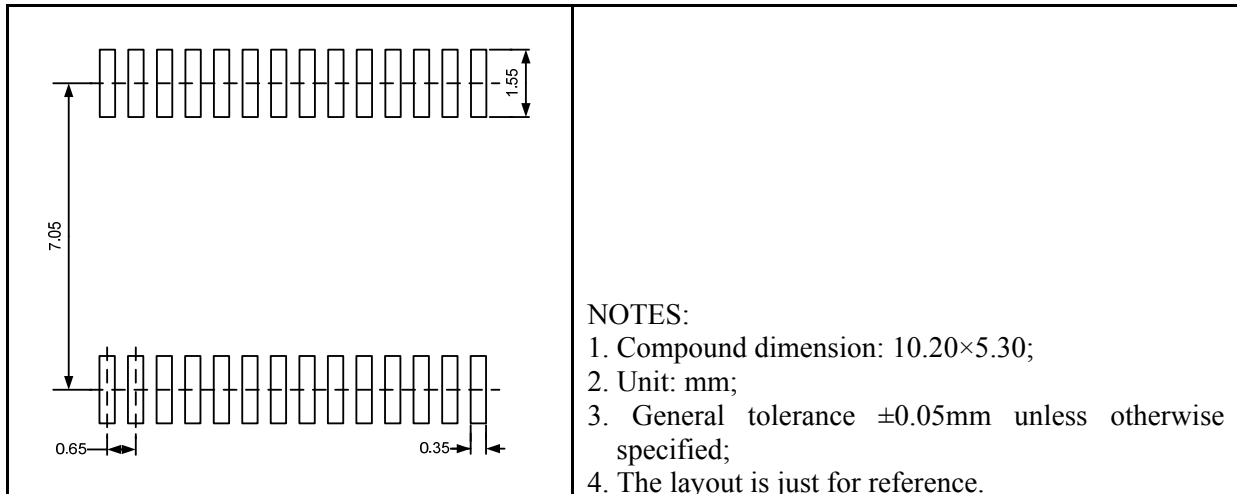

Tape and Reel Orientation



UM213EEUS TSSOP28

Outline Drawing

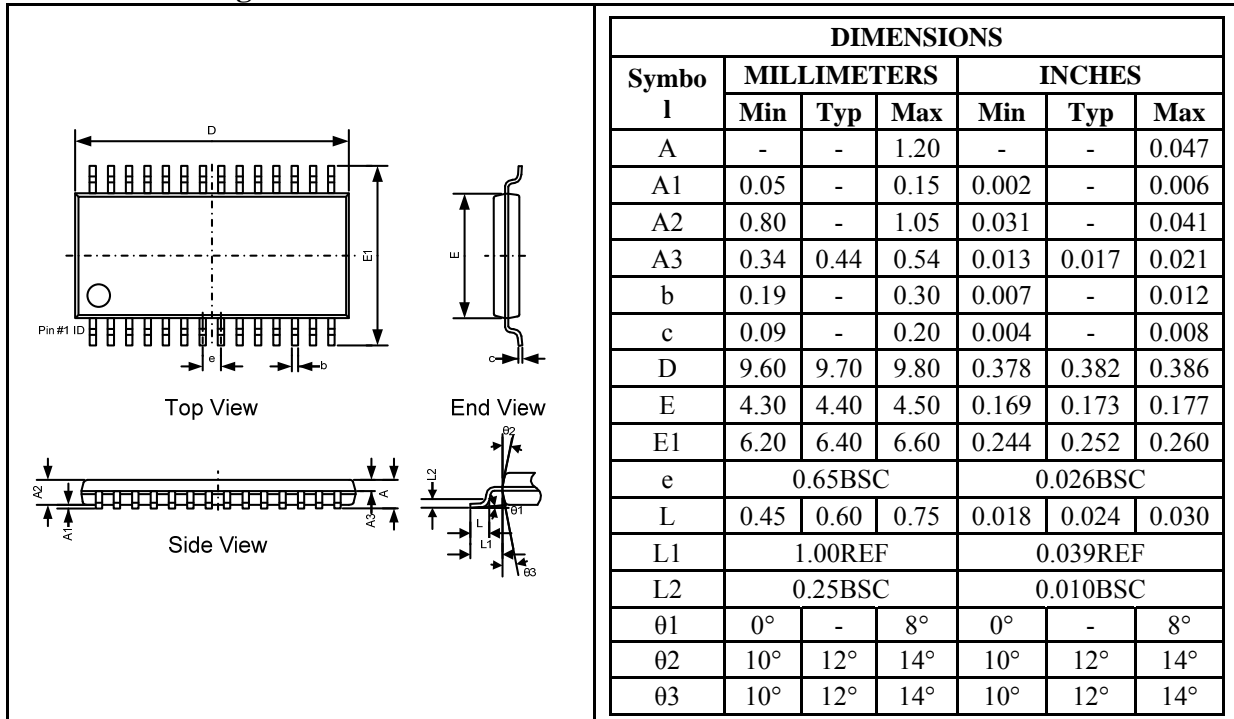

Land Pattern

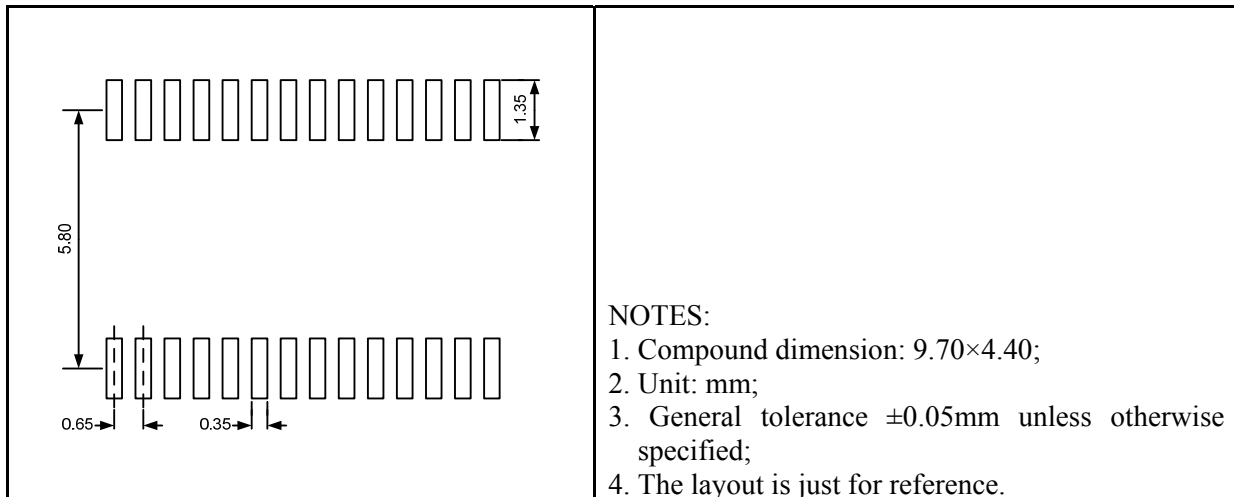

Tape and Reel Orientation



GREEN COMPLIANCE

Union Semiconductor is committed to environmental excellence in all aspects of its operations including meeting or exceeding regulatory requirements with respect to the use of hazardous substances. Numerous successful programs have been implemented to reduce the use of hazardous substances and/or emissions.

All Union components are compliant with the RoHS directive, which helps to support customers in their compliance with environmental directives. For more green compliance information, please visit:

http://www.union-ic.com/index.aspx?cat_code=RoHSDeclaration

IMPORTANT NOTICE

The information in this document has been carefully reviewed and is believed to be accurate. Nonetheless, this document is subject to change without notice. Union assumes no responsibility for any inaccuracies that may be contained in this document, and makes no commitment to update or to keep current the contained information, or to notify a person or organization of any update. Union reserves the right to make changes, at any time, in order to improve reliability, function or design and to attempt to supply the best product possible.



Union Semiconductor, Inc

Add: Unit 606, No.570 Shengxia Road, Shanghai 201210

Tel: 021-51093966

Fax: 021-51026018

Website: www.union-ic.com

X-ON Electronics

Largest Supplier of Electrical and Electronic Components

Click to view similar products for [RS-232 Interface IC category](#):

Click to view products by [Union manufacturer](#):

Other Similar products are found below :

[062191EB](#) [XR32330EBERTR-F](#) [HIN202CB](#) [HIN202CBN](#) [HIN202EIB](#) [HIN206CB](#) [HIN206EIA](#) [HIN207EIAZ](#) [HIN207EIBZ](#) [HIN208ECB](#)
[HIN213EIB](#) [HIN232ACB](#) [HIN232ACBN](#) [HIN232ACP](#) [HIN232CB](#) [HIN232ECP](#) [HIN232IB](#) [HIN232IP](#) [HIN238CB](#) [HIN239CB](#) [HIN241CA](#)
[ICL232CBE](#) [ICL232IBE](#) [ICL3207ECA](#) [ICL3217ECB](#) [ICL3221CV](#) [ICL3221ECA](#) [ICL3221ECV](#) [ICL3221IA](#) [ICL3223CA](#) [ICL3223ECA](#)
[ICL3223IA](#) [ICL3225ECA](#) [ICL3232CA](#) [ICL3232CP](#) [ICL3232CV](#) [ICL3232ECB](#) [ICL3232IBN](#) [ICL3232IV](#) [ICL3237CA](#) [ICL3237ECA](#)
[ICL3238ECA](#) [ICL3241ECA](#) [ICL3243CA](#) [ICL3243CB](#) [ICL3243ECA](#) [ICL3243ECB](#) [ICL3243ECV](#) [ICL3243IA](#) [ICL3245ECA](#)