

8-Bit Bidirectional Voltage-Level Translator for Open-Drain and Push-Pull Application

UM3208H CSP20 2.4×1.9

UM3208QA QFN20 4.5×3.5

UM3208UK TSSOP20

General Description

The UM3208 is 8-channel ESD-protected level translator provides the level shifting necessary to allow data transfer in a multi-voltage system. Externally applied voltages, V_{CCB} and V_{CCA} , set the logic levels on either side of the device. A low-voltage logic signal present on the V_{CCA} side of the device appears as a high-voltage logic signal on the V_{CCB} side of the device, and vice-versa. The UM3208 bidirectional level translator utilizes a transmission-gate based design to allow data translation in either direction ($V_{CCA} \leftrightarrow V_{CCB}$) on any single data line. The UM3208 accepts V_{CCA} from +1.65V to +3.6V and V_{CCB} from +2.3V to +5.5V, making it ideal for data transfer between low-voltage ASICs / PLDs and higher voltage systems.

The UM3208 enters a three-state output mode to reduce supply current when output enable (OE) is low. The UM3208 is designed so that the OE input circuit is supplied by V_{CCA} . ±6kV ESD protection on the V_{CCB} side for greater protection in applications that route signals externally.

The UM3208H is available in CSP20 2.4×1.9 bump package and specially features in wafer backside coating process, making the chip more robust. The UM3208UK is available in TSSOP20 package and the UM3208QA is available in QFN20 4.5×3.5 package.

Applications

- SPI, MICROWRE, and I²C Level Translation
- Low-Voltage ASIC Level Translation
- Smart Card Readers
- Cell-phone Cradles
- Portable POS Systems
- Portable Communication Devices
- Low-Cost Serial Interfaces
- Cell-Phones
- GPS
- Telecommunications Equipment

Features

- Max Data Rates:
24Mbps(Push Pull),
2Mbps(Open Drain)
- Bidirectional Level Translation
- 1.65V to 3.6V on A port and 2.3V to 5.5V on B port($V_{CCA} \leq V_{CCB}$)
- ±6kV ESD Protection on B port
- Latch-Up Performance Exceeds 100mA
- No Power-Supply Sequencing Required
 V_{CCA} or V_{CCB} Can Be Ramped First
- Low Power Consumption

Pin Configurations

Top View

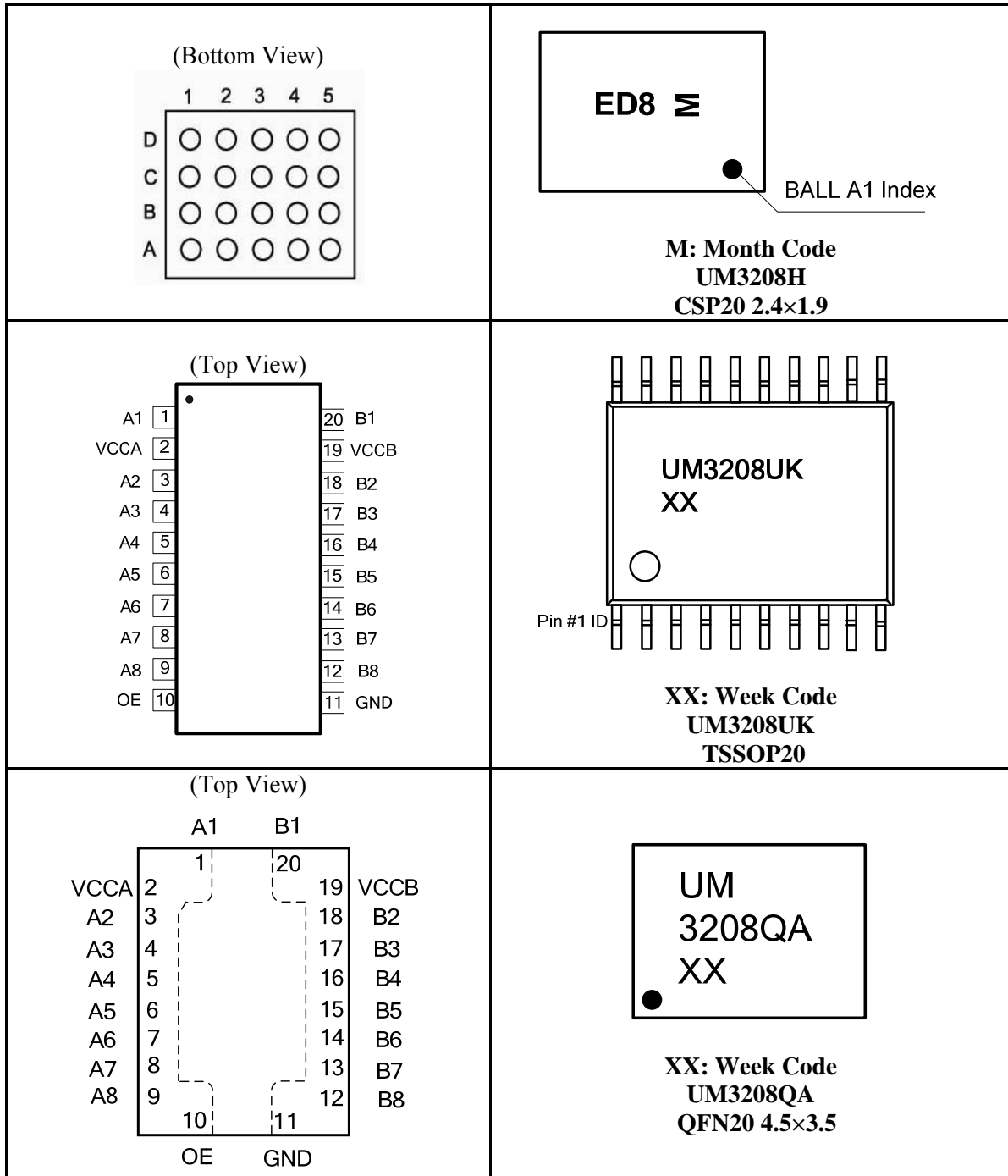

Ball Mapping for UM3208H

	5	4	3	2	1
D	B8	B6	B4	B2	V _{CCB}
C	GND	B7	B5	B3	B1
B	OE	A7	A5	A3	A1
A	A8	A6	A4	A2	V _{CCA}

Transparent Top View

Pin Description

Pin Name	Function
A1	Input/Output 1. Referenced to V _{CCA}
V _{CCA}	A-Port supply voltage. $1.65V \leq V_{CCA} \leq 3.6V$ and $V_{CCA} \leq V_{CCB}$
A2	Input/Output 2. Referenced to V _{CCA}
A3	Input/Output 3. Referenced to V _{CCA}
A4	Input/Output 4. Referenced to V _{CCA}
A5	Input/Output 5. Referenced to V _{CCA}
A6	Input/Output 6. Referenced to V _{CCA}
A7	Input/Output 7. Referenced to V _{CCA}
A8	Input/Output 8. Referenced to V _{CCA}
OE	3-state output enable. Pull OE low to place all outputs in 3-state mode. Referenced to V _{CCA}
GND	Ground
B8	Input/Output 8. Referenced to V _{CCB}
B7	Input/Output 7. Referenced to V _{CCB}
B6	Input/Output 6. Referenced to V _{CCB}
B5	Input/Output 5. Referenced to V _{CCB}
B4	Input/Output 4. Referenced to V _{CCB}
B3	Input/Output 3. Referenced to V _{CCB}
B2	Input/Output 2. Referenced to V _{CCB}
V _{CCB}	B-Port supply voltage. $2.3V \leq V_{CCB} \leq 5.5V$
B1	Input/Output 1. Referenced to V _{CCB}

Ordering Information

Part Number	Packaging Type	Marking Code	Shipping Qty
UM3208H	CSP20 2.4×1.9	ED8	3000pcs/7Inch Tape & Reel
UM3208UK	TSSOP20	UM3208UK	3000pcs/13Inch Tape & Reel
UM3208QA	QFN20 4.5×3.5	UM3208QA	

Absolute Maximum Ratings (Note 1)

Over operating free-air temperature range (unless otherwise noted)

Symbol	Parameter	Value	Unit
V _{CCA}	Supply Voltage Range	-0.5 to +4.5	V
V _{CCB}	Supply Voltage Range	-0.5 to +6.5	V
V _I	Input Voltage Range	A ports	-0.5 to +4.5
		B ports	-0.5 to +6.5
V _O	Voltage Range applied to any output in the high-impedance or power-off state	A ports	-0.5 to +4.5
		B ports	-0.5 to +6.5
V _O	Voltage Range applied to any output in the high or low state (Note 2)	A ports	-0.5 to (V _{CCA} +0.5)
		B ports	-0.5 to (V _{CCB} +0.5)
I _{IK}	Input Clamp Current	V _I <0	-50
I _{OK}	Output Clamp Current	V _O <0	-50
I _O	Continuous Output Current		±50
	Continuous Current through V _{CCA} , V _{CCB} , or GND		±100
T _{OP}	Operating Temperature Range	-40 to +85	°C
T _J	Junction Temperature	-40 to +165	°C
T _{STG}	Storage Temperature Range	-65 to +150	°C

Note1. Stresses beyond those listed under "absolute maximum ratings" may cause permanent damage to the device. These are stress ratings only, and functional operation of the device at these or any other conditions beyond those indicated under "recommended operating conditions" is not implied. Exposure to absolute-maximum-rated conditions for extended periods may affect device reliability.

Note2. The value of V_{CCA} and V_{CCB} are provided in the recommended operating conditions table.

Recommended Operating Conditions (Note 1, 2)

Symbol	Parameter	V _{CCA}	V _{CCB}	Min	Max	Unit	
V _{CCA}	Supply Voltage			1.65	3.6	V	
V _{CCB}				2.3	5.5	V	
V _{IH}	High Level Input Voltage	A- Port	1.65V to 1.95V 2.3V to 3.6V	2.3V to 5.5V	V _{CCI} -0.2	V _{CCI}	
					V _{CCI} -0.4	V _{CCI}	
		B- Port	1.65V to 3.6V	2.3V to 5.5V	V _{CCI} -0.4	V _{CCI}	
V _{IL}	Low Level Input Voltage	A- Port	1.65V to 3.6V	2.3V to 5.5V	0	0.15	
					B- Port	0	0.15
					OE	0	V _{CCA} ×0.35
Δt/Δv	Input Transition Rise or Fall Time	A-Port push-pull driving	1.65V to 3.6V	2.3V to 5.5V	10	ns/V	
		B-Port push-pull driving			10		
		Control input			10		

Note1. V_{CCI} is the supply voltage associated with the input port.

Note2. V_{CCA} must be less than or equal to V_{CCB} and must not exceed 3.6 V.

Thermal Information

Thermal Metric	UM3208H	UM3208QA	UM3208UK	UNIT
R _{θJA}	47	80.9	70	°C/W

Electrical Characteristics(Note 1, 2, 3)

Over recommended operating free-air temperature range (unless otherwise noted)

Parameter	Test Conditions	V _{CCA}	V _{CCB}	T _A =25°C		-40°C to 85°C		Unit
				Typ	Max	Min	Max	
V _{OHA}	I _{OH} =-20μA V _{IB} ≥V _{CCB} -0.4V	1.65V to 3.6V	2.3V to 5.5V			V _{CCA} *0.8		V
V _{OLA}	I _{OL} =1mA V _{IB} ≤0.15V	1.65V to 3.6V	2.3V to 5.5V			0.2		V
V _{OHB}	I _{OH} =-20μA V _{IA} ≥V _{CCA} -0.2V	1.65V to 3.6V	2.3V to 5.5V			V _{CCB} *0.8		V
V _{OLB}	I _{OL} =1mA V _{IA} ≤0.15V	1.65V to 3.6V	2.3V to 5.5V			0.2		V
I _I	OE	V _I =V _{CCI} or GND	1.65V to 3.6V	2.3V to 5.5V	±1		±2	μA
I _{OZ}	A or B Port	OE=V _{IL}	1.65V to 3.6V	2.3V to 5.5V	±1		±2	μA
I _{CCA}	V _I =V _O =open, I _O =0	1.65V to V _{CCB}	2.3V to 5.5V			2.4		μA
		3.6V	0V			2.2		
		0V	5.5V			-1		
I _{CCB}	V _I =V _O =open, I _O =0	1.65V to V _{CCB}	2.3V to 5.5V			12		μA
		3.6V	0V			-1		
		0V	5.5V			1		
I _{CCA} + I _{CCB}	V _I =V _O =open, I _O =0	1.65V to 3.6V	2.3V to 5.5V			14.4		μA
C _i	OE		3.3V	3.3V	2.5		3.5	pF
C _{io}	A Port		3.3V	3.3V	5		6.5	pF
	B Port				12		16.5	

 Note1. V_{CCI} is the supply voltage associated with the input port.

 Note2. V_{CCO} is the supply voltage associated with the output port.

 Note3. V_{CCA} must be less than or equal to V_{CCB} and must not exceed 3.6 V.

Timing Requirements

 Over recommended operating free-air temperature range, V_{CCA} = 1.8V ± 0.15V (unless otherwise noted)

		V _{CCB} =2.5V ± 0.2V	V _{CCB} =3.3V ± 0.3V	V _{CCB} =5V ± 0.5V	Unit
		Min	Max	Min	Max
Data Rate	Push-pull driving	24		24	
	Open-drain driving	2		2	
t _w Pulse duration	Push-pull driving	41		41	
	Open-drain driving	500		500	

Timing Requirements

 Over recommended operating free-air temperature range, V_{CCA} = 2.5V ± 0.2V (unless otherwise noted)

		V _{CCB} =2.5V ± 0.2V	V _{CCB} =3.3V ± 0.3V	V _{CCB} =5V ± 0.5V	Unit
		Min	Max	Min	Max
Data Rate	Push-pull driving	24		24	
	Open-drain driving	2		2	
t _w Pulse duration	Push-pull driving	41		41	
	Open-drain driving	500		500	

Timing Requirements

 Over recommended operating free-air temperature range, $V_{CCA} = 3.3V \pm 0.3V$ (unless otherwise noted)

		$V_{CCB}=3.3V \pm 0.3V$		$V_{CCB}=5V \pm 0.5V$		Unit
		Min	Max	Min	Max	
Data Rate	Push-pull driving	24		24		Mbps
	Open-drain driving	2		2		
t_w Pulse duration	Push-pull driving	41		41		ns
	Open-drain driving	500		500		

Switching Characteristics

 Over recommended operating free-air temperature range, $V_{CCA} = 1.8V \pm 0.15V$ (unless otherwise noted)

Parameter	From (Input)	To (Output)	Test Conditions	$V_{CCB}=2.5V \pm 0.2V$		$V_{CCB}=3.3V \pm 0.3V$		$V_{CCB}=5V \pm 0.5V$		Unit
				Min	Max	Min	Max	Min	Max	
t_{PHL}	A	B	Push-pull	4.6		4.7		5.8		ns
			Open-drain	2.9	8.8	2.9	9.6	3	10	
t_{PLH}			Push-pull	6.8		6.8		7		
			Open-drain	45	260	36	208	27	198	
t_{PHL}	B	A	Push-pull	4.4		4.5		4.7		ns
			Open-drain	1.9	5.3	1.1	4.4	1.2	4	
t_{PLH}			Push-pull	5.3		4.5		0.5		
			Open-drain	45	175	36	140	27	102	
t_{en}	OE	A	200		200		200		ns	
		B	200		200		200			
t_{dis}	OE	A	50		40		35		ns	
		B	50		40		35			
t_{rA}	A port rise time		Push-pull	3.2	9.5	2.3	9.3	2	7.6	ns
			Open-drain	38	165	30	132	22	95	
t_{rB}	B port rise time		Push-pull	4	10.8	2.7	9.1	2.7	7.6	ns
			Open-drain	34	145	23	106	10	58	
t_{fA}	A port fall time		Push-pull	2	5.9	1.9	6	1.7	13.3	ns
			Open-drain	4.4	6.9	4.3	6.4	4.2	6.1	
t_{fB}	B port fall time		Push-pull	2.9	7.6	2.8	7.5	2.8	8.8	ns
			Open-drain	6.9	13.8	7.5	16.2	7	16.2	
$t_{SK(O)}$	Channel-to-Channel		1		1		1		ns	
Max data rate			Push-pull	24		24		24		Mbps
			Open-drain	2		2		2		

Switching Characteristics

 Over recommended operating free-air temperature range, $V_{CCA} = 2.5V \pm 0.2V$ (unless otherwise noted)

Parameter	From (Input)	To (Output)	Test Conditions	$V_{CCB}=2.5V \pm 0.2V$		$V_{CCB}=3.3V \pm 0.3V$		$V_{CCB}=5V \pm 0.5V$		Unit
				Min	Max	Min	Max	Min	Max	
t_{PHL}	A	B	Push-pull		3.2		3.3		3.4	ns
			Open-drain	1.7	6.3	2	6	2.1	5.8	
t_{PLH}			Push-pull		3.5		4.1		4.4	
			Open-drain	43	250	36	206	27	190	
t_{PHL}	B	A	Push-pull		3		3.6		4.3	ns
			Open-drain	1.8	4.7	2.6	4.2	1.2	4	
t_{PLH}			Push-pull		2.5		1.6		0.7	
			Open-drain	44	170	37	140	27	103	
t_{en}	OE	A		200		200		200	ns	
		B		200		200		200		
t_{dis}	OE	A		50		40		35	ns	
		B		50		40		35		
t_{rA}	A port rise time		Push-pull	2.8	7.4	2.6	6.6	1.8	5.6	ns
			Open-drain	34	149	28	121	24	89	
t_{rB}	B port rise time		Push-pull	3.2	8.3	2.9	7.2	2.4	6.1	ns
			Open-drain	35	151	24	112	12	64	
t_{fA}	A port fall time		Push-pull	1.9	5.7	1.9	5.5	1.8	5.3	ns
			Open-drain	4.4	6.9	4.3	6.2	4.2	5.8	
t_{fB}	B port fall time		Push-pull	2.2	7.8	2.4	6.7	2.6	6.6	ns
			Open-drain	5.1	8.8	5.4	9.4	5.4	10.4	
$t_{SK(O)}$	Channel-to-channel			1		1		1	ns	
Max data rate			Push-pull	24		24		24		
			Open-drain	2		2		2	Mbps	

Switching Characteristics

 Over recommended operating free-air temperature range, $V_{CCA} = 3.3V \pm 0.3V$ (unless otherwise noted)

Parameter	From (Input)	To (Output)	Test Conditions	$V_{CCB}=3.3V \pm 0.3V$		$V_{CCB}=5V \pm 0.5V$		Unit
				Min	Max	Min	Max	
t_{PHL}	A	B	Push-pull		2.4		3.1	ns
			Open-drain	1.2	4.2	1.4	4.6	
t_{PLH}			Push-pull		4.2		4.4	
			Open-drain	36	204	28	165	
t_{PHL}	B	A	Push-pull		2.5		3.3	ns
			Open-drain	1	124	1	97	
t_{PLH}			Push-pull		2.5		2.6	
			Open-drain	3	139	3	105	
t_{en}	OE	A		200		200	ns	
		B		200		200		
t_{dis}	OE	A		40		35	ns	
		B		40		35		
t_{rA}	A port rise time		Push-pull	2.3	5.6	1.9	4.8	ns
			Open-drain	25	116	19	85	
t_{rB}	B port rise time		Push-pull	2.5	6.4	2.1	7.4	ns
			Open-drain	26	116	14	72	
t_{fA}	A port fall time		Push-pull	2	5.4	1.9	5	ns
			Open-drain	4.3	6.1	4.2	5.7	
t_{fB}	B port fall time		Push-pull	2.3	7.4	2.4	7.6	ns
			Open-drain	5	7.6	4.8	8.3	
$t_{SK(O)}$	Channel-to-channel			1		1	ns	
Max data rate			Push-pull	24		24		
			Open-drain	2		2	Mbps	

Applications Information

The UM3208 can be used in level-translation applications for interfacing devices or systems operating at different interface voltages with one another. The UM3208 is ideal for use in application where an open-drain driver is connected to the data I/Os. The UM3208 can also be used in applications where a push-pull driver is connected to the data I/Os, but the UM3308 is better choice for push-pull applications.

Block Diagram

The UM3208 (block diagram see Figure 1) does not require a direction-control signal to control the direction of data flow from A to B or from B to A. Each A-port I/O has an internal 10-k Ω pull-up resistor to V_{CCA} , and each B-port I/O has an internal 10-k Ω pull-up resistor to V_{CCB} . During a rising edge, the one-shot turns on the PMOS transistors (PU1, PU2) for a short duration, which speeds up the low-to-high transition.

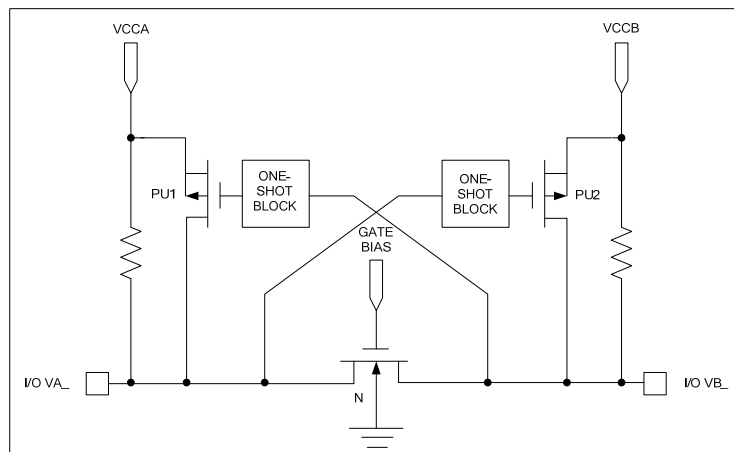

Figure 1 Block Diagram of UM3208 I/O Cell

Input Driver Requirements

The fall time (t_{fA} , t_{fB}) of a signal depends on the output impedance of the external device driving the data I/Os of the UM3208. Similarly, the t_{PHL} and the maximum data rates also depend on the output impedance of the external driver. The values for t_{fA} , t_{fB} , t_{PHL} , and the maximum data rates in the data sheet assume that the output impedance of the external driver is less than 50 Ω .

Power Up

During operation, ensure that $V_{CCA} \leq V_{CCB}$ at all times. During power-up sequencing, $V_{CCA} \geq V_{CCB}$ does not damage the device, so any power supply can be ramped up first.

Enable and Disable

The UM3208 has an OE input that is used to disable the device by setting OE = low, which places all I/Os in the high-impedance (Hi-Z) state. The disable time (t_{dis}) indicates the delay between the time when OE goes low and when the outputs actually get disabled (Hi-Z). The enable time (t_{en}) indicates the amount of time the user must allow for the one-shot circuitry to become operational after OE is taken high.

Pull-up or Pull-down Resistors on I/O Lines

Each A-port I/O has an internal 10-k Ω pull-up resistor to V_{CCA} , and each B-port I/O has an internal 10-k Ω pull-up resistor to V_{CCB} . If a smaller value of pull-up resistor is required, an external resistor must be added from the I/O to V_{CCA} or V_{CCB} (in parallel with the internal 10-k Ω resistor).

Test Circuits

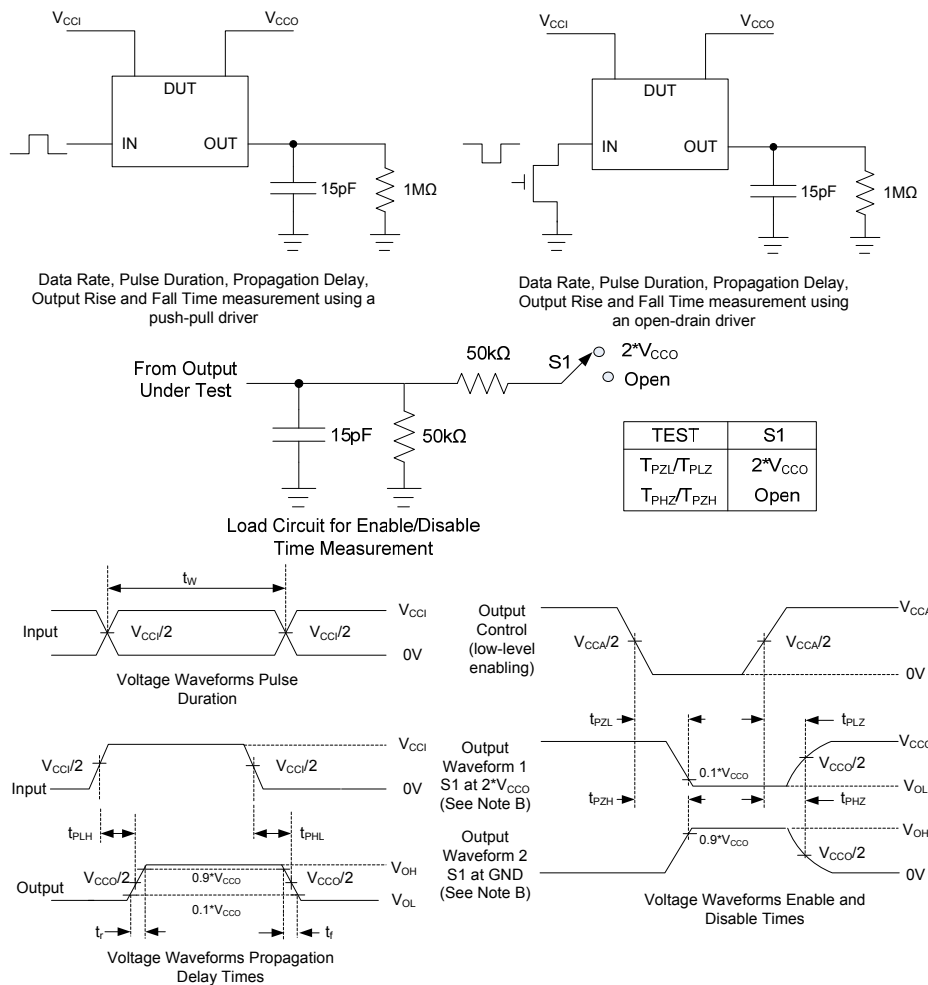

- A. C_L includes probe and jig capacitances.
- B. Waveform 1 is for an output with internal conditions such that the output is low, except when disabled by the output control.
Waveform 2 is for an output with internal conditions such that the output is high, except when disabled by the output control.
- C. All input pulses are supplied by generators having the following characteristics: $PRR \leq 100\text{MHz}$, $Z_0 = 50\Omega$, $dv/dt \geq 1\text{V/ns}$.
- D. The outputs are measured one at a time, with one transition per measurement.
- E. T_{PLZ} and T_{PHZ} are the same as t_{dis} .
- F. T_{PZL} and T_{PZH} are the same as t_{en} .
- G. T_{PLH} and T_{PHL} are the same as t_{pd} .
- H. V_{CCI} is the V_{CC} associated with the input port.
- I. V_{CCO} is the V_{CC} associated with the output port.
- J. All parameters and waveforms are not applicable to all devices.

Figure 2 Load Circuits and Voltage Waveforms

Typical Characteristics

Low-level Output Voltage vs. Low-level Output Current

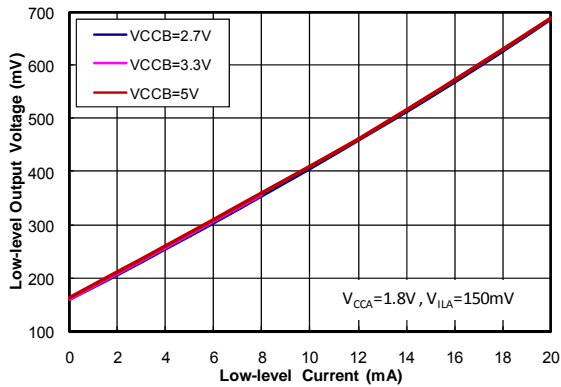

Low-level Output Voltage vs. Low-level Output Current

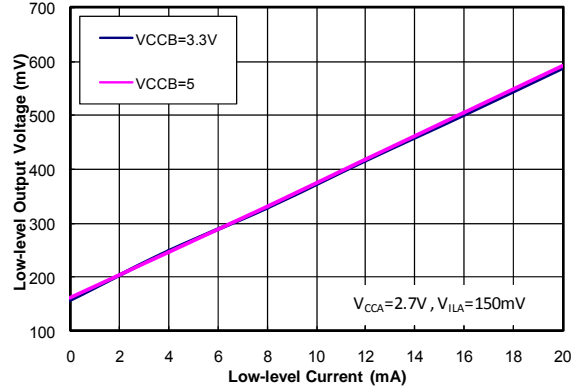

Low-level Output Voltage vs. Low-level Output Current

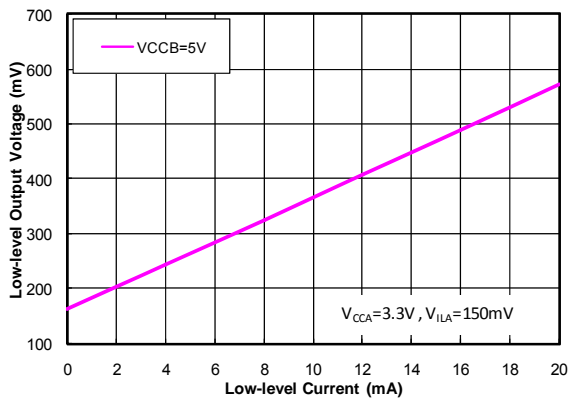

Low-level Output Voltage vs. Low-level Output Current

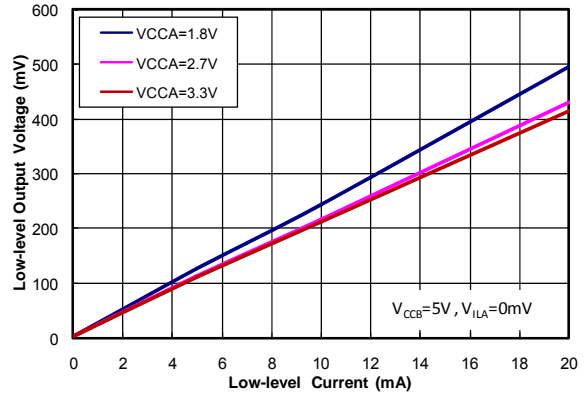

High-level Output Voltage vs. High-level Output Current

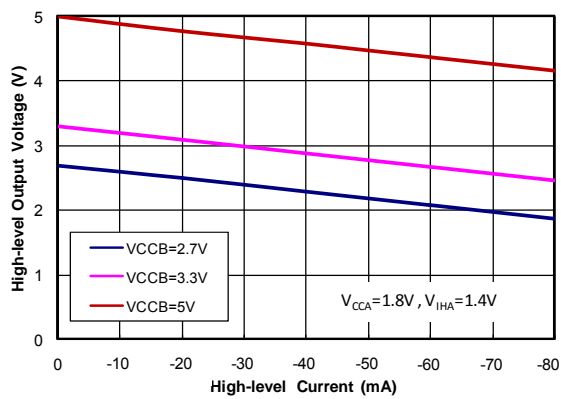

High-level Output Voltage vs. High-level Output Current

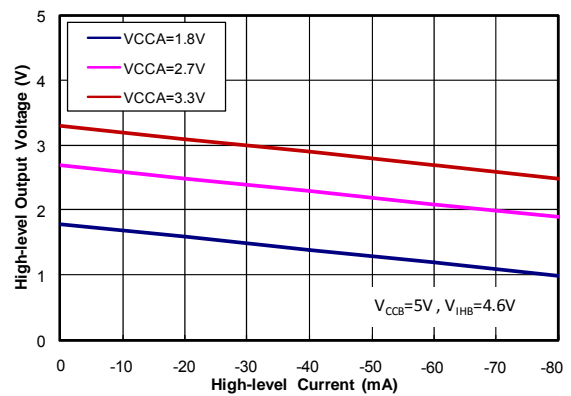

Package Information

UM3208H CSP20 2.4×1.9

Outline Drawing

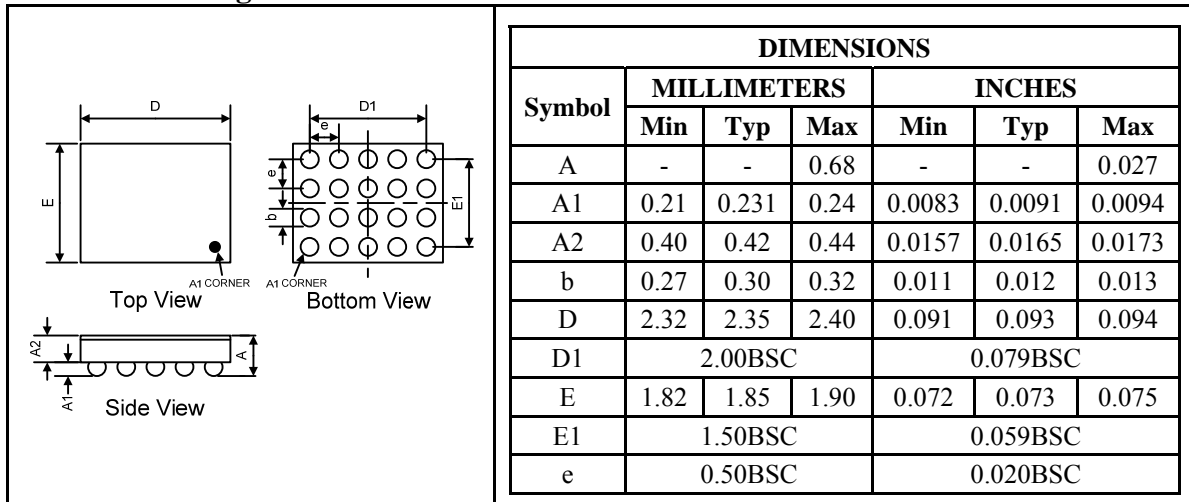

Land Pattern

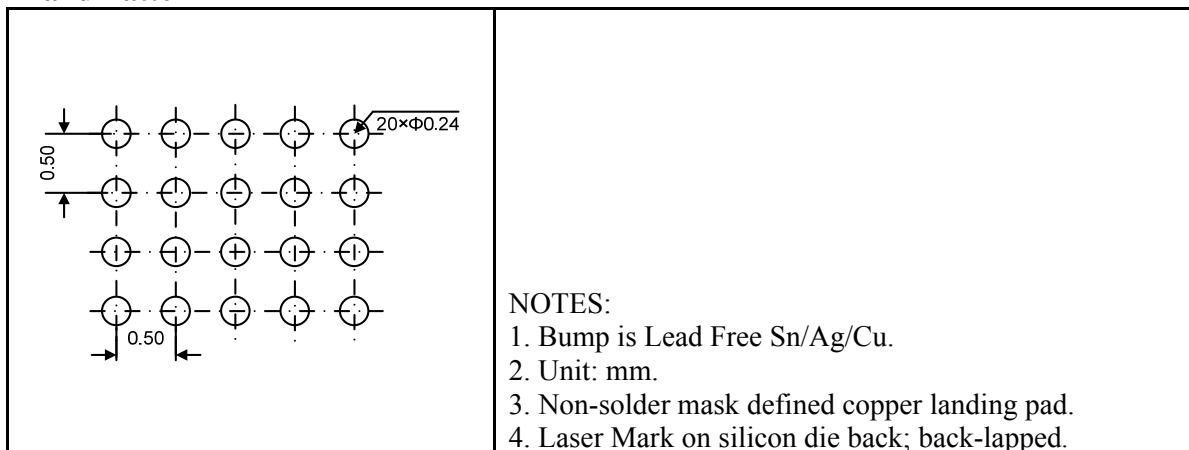

Tape and Reel Orientation



UM3208UK TSSOP20

Outline Drawing

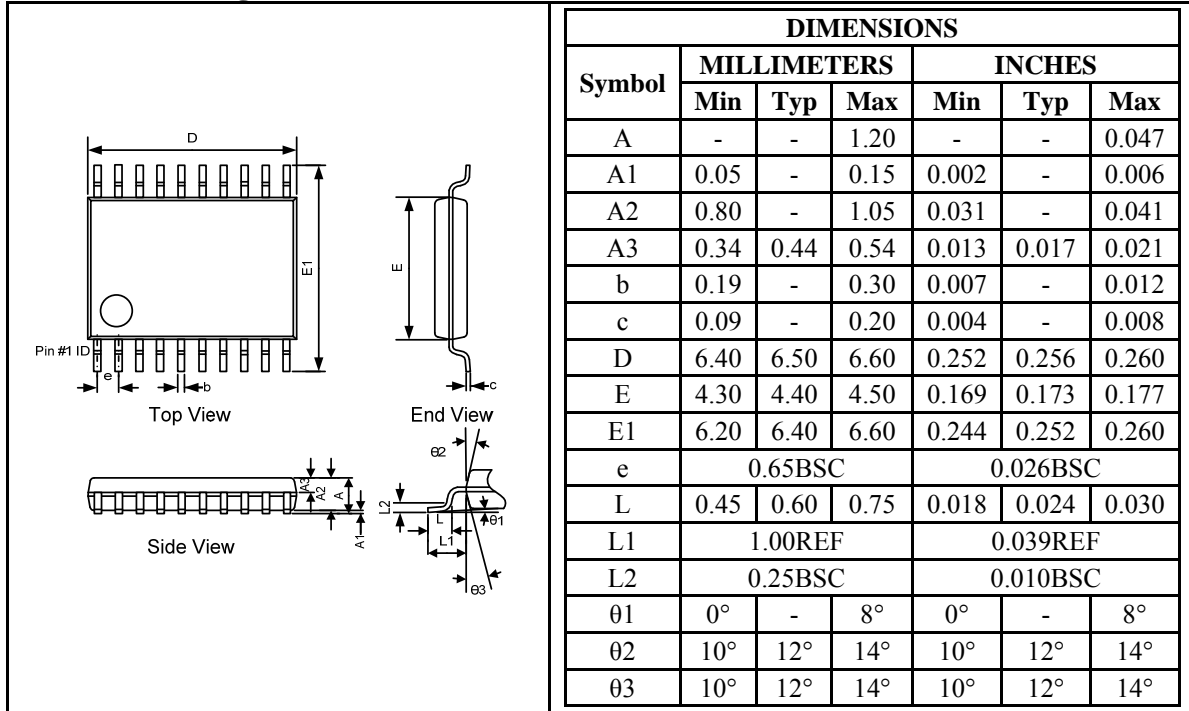

Land Pattern

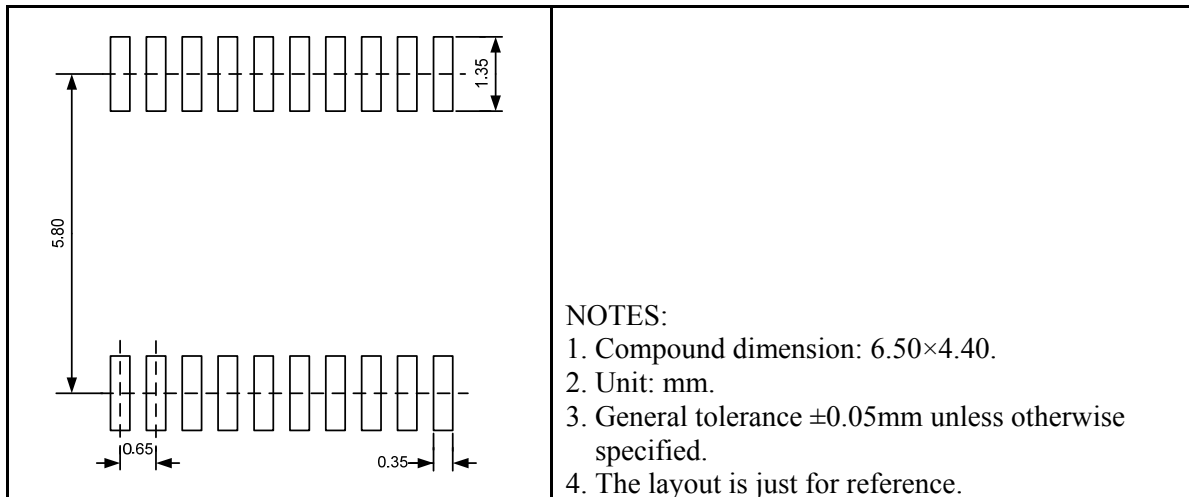

Tape and Reel Orientation

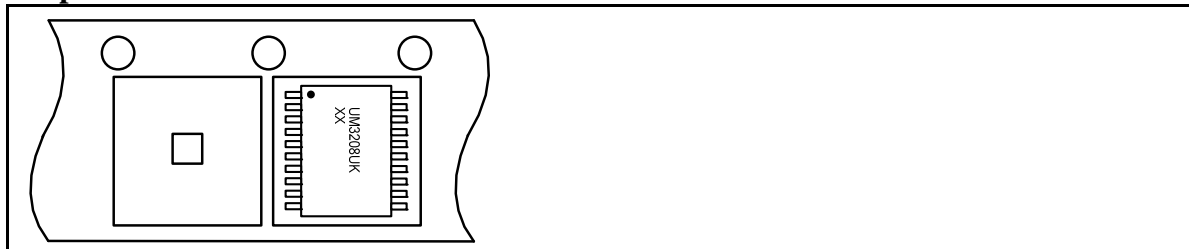

UM3208QA QFN20 4.5×3.5

Outline Drawing

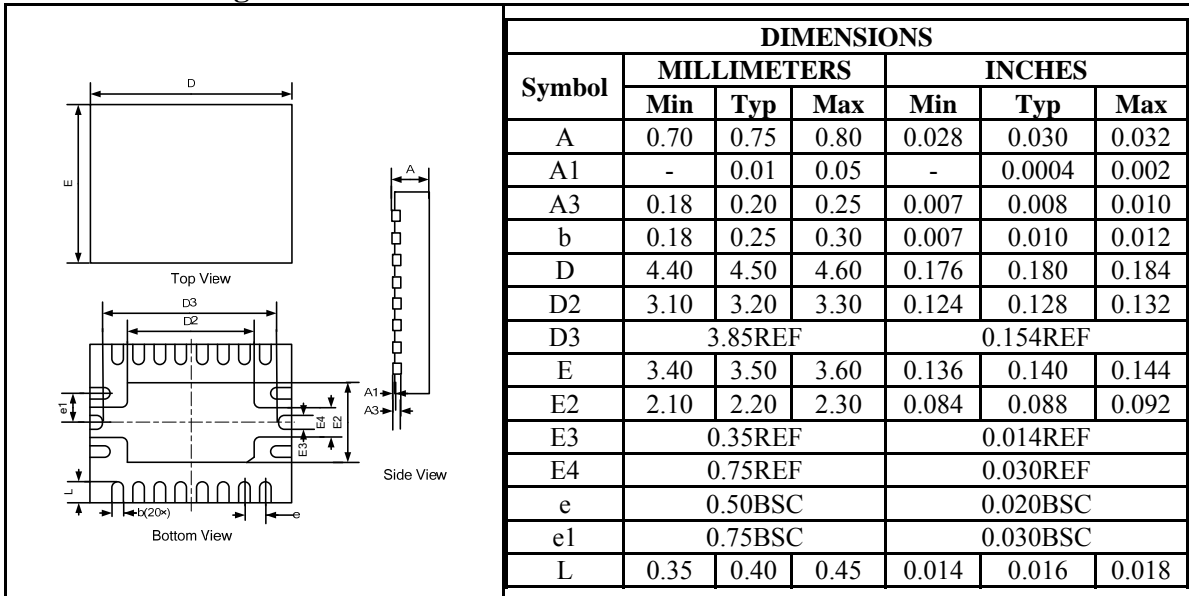

Land Pattern

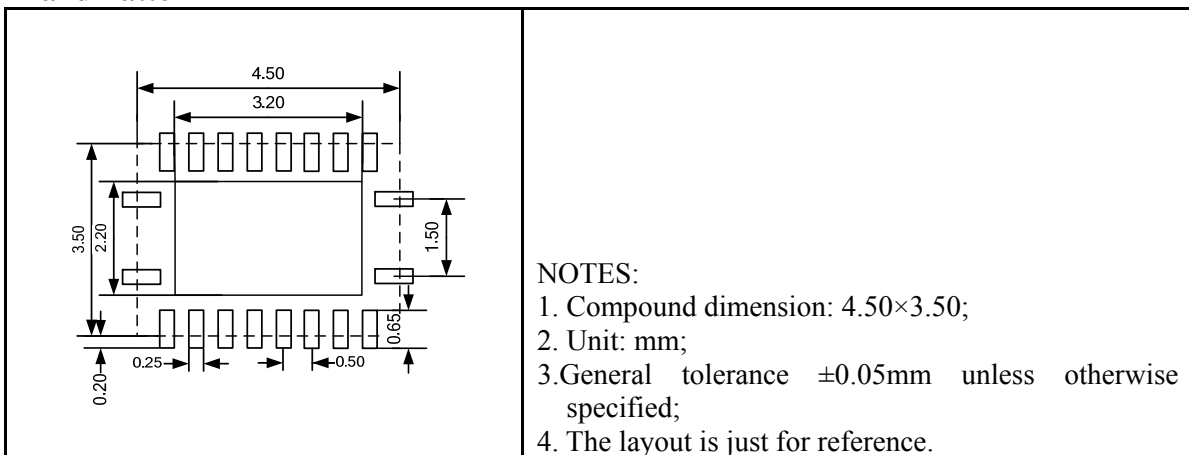

Tape and Reel Orientation



GREEN COMPLIANCE

Union Semiconductor is committed to environmental excellence in all aspects of its operations including meeting or exceeding regulatory requirements with respect to the use of hazardous substances. Numerous successful programs have been implemented to reduce the use of hazardous substances and/or emissions.

All Union components are compliant with the RoHS directive, which helps to support customers in their compliance with environmental directives. For more green compliance information, please visit:

http://www.union-ic.com/index.aspx?cat_code=RoHSDeclaration

IMPORTANT NOTICE

The information in this document has been carefully reviewed and is believed to be accurate. Nonetheless, this document is subject to change without notice. Union assumes no responsibility for any inaccuracies that may be contained in this document, and makes no commitment to update or to keep current the contained information, or to notify a person or organization of any update. Union reserves the right to make changes, at any time, in order to improve reliability, function or design and to attempt to supply the best product possible.



Union Semiconductor, Inc

Add: Unit 606, No.570 Shengxia Road, Shanghai 201210

Tel: 021-51093966

Fax: 021-51026018

Website: www.union-ic.com

X-ON Electronics

Largest Supplier of Electrical and Electronic Components

Click to view similar products for [Translation - Voltage Levels](#) category:

Click to view products by [Union manufacturer](#):

Other Similar products are found below :

[NLSX4373DMR2G](#) [NLSX5012MUTAG](#) [NLSX0102FCT1G](#) [NLSX0102FCT2G](#) [PCA9306FMUTAG](#) [MC100EPT622MNG](#)
[NLSX3014MUTAG](#) [NLSV4T244EMUTAG](#) [NLSX5011MUTCG](#) [NLVSX4373MUTAG](#) [NB3U23CMNTAG](#) [NLVPCA9306AMUTCG](#)
[NLSX3013BFCT1G](#) [NLSX3012DMR2G](#) [NLA9306MU3TCG](#) [NVT2001GMZ](#) [P3A9606JKZ](#) [NLVSV1T244MUTBG](#) [NLSX5011AMUTAG](#)
[74AXP1T34GWH](#) [MS4553S](#) [HT7660ARZ](#) [RS0108YQ20](#) [UM3204Q](#) [UM3204UE](#) [UM3204H](#) [UM3208UK](#) [UM3202Q](#) [RS8T245YTSS24](#)
[UM3308UK](#) [UM3212M8](#) [UM3304QA](#) [AW39104FOR](#) [RS0101YH6](#) [CLVC16T245MDGGREP](#) [CAVCB164245MDGGREP](#) [NTS0102DP-](#)
[Q100H](#) [FXLA104UM12X](#) [FXMA2102UMX](#) [PI4ULS5V201TAEX](#) [CD40109BPWR](#) [SY89321LMG-TR](#) [SY100ELT22ZG](#) [TXS0102DCTRE4](#)
[MC10H350FNG](#) [MC10H125FNR2G](#) [MC100EPT21MNR4G](#) [MC100EP91DWG](#) [MAX13030EETE+](#) [NLSX3018MUTAG](#)