

***4-Bit Bidirectional Voltage-Level Translator with Auto Direction Sensing and  $\pm 4kV$  ESD Protection*****UM3304 CSP12 1.9×1.4****UM3304QS QFN14 3.5×3.5****UM3304QT QFN16 2.6×1.8****UM3304QA QFN12 1.7×2.0****UM3304UE TSSOP14****General Description**

UM3304/UM3304QS/UM3304QT/UM3304QA/UM3304UE is quad channel level translator with auto direction sensing and  $\pm 4kV$  ESD protection. This 4-channel non-inverting translator uses two separate configurable power-supply rails. The A port is designed to track  $V_{CCA}$ .  $V_{CCA}$  accepts any supply voltage from 1.2V to 3.6V. The B port is designed to track  $V_{CCB}$ .  $V_{CCB}$  accepts any supply voltage from 1.65V to 5.5V. This allows for universal low-voltage bidirectional translation between any of the 1.2V, 1.5V, 1.8V, 2.5V, 3.3V, and 5V voltage nodes.  $V_{CCA}$  should not exceed  $V_{CCB}$ . Both I/O ports are auto-sensing; thus, no direction pin is required, making it ideal for data transfer between low-voltage ASICs/PLDs and higher voltage systems.

The UM3304/UM3304QS/UM3304QT/UM3304QA/UM3304UE operates at a guaranteed data rate of 20Mbps over the entire specified operating voltage range. Within specific voltage domains, higher data rates are up to 100Mbps.

When the output-enable (OE) input is low, all outputs are placed in the high-impedance state. The UM3304/UM3304QS/UM3304QT/UM3304QA/UM3304UE is designed so that the OE input circuit is tracked to  $V_{CCA}$ .

The UM3304 is a quad level translator available in 1.90mm×1.40mm CSP12 bump package while the UM3304QS is packaged in a 3.50mm×3.50mm QFN14 package, the UM3304QT is packaged in a 2.60mm×1.80mm QFN16 package, the UM3304QA is packaged in 1.70mm×2.00mm QFN12 package and the UM3304UE is packaged in TSSOP14 package.

**Applications**



- Low-Voltage ASIC Level Translation
- Cell-Phone Cradles
- Portable POS Systems
- Portable Communication Devices
- Low-Cost Serial Interfaces
- Cell-Phones
- GPS
- Telecommunications Equipment

**Features**

- 1.2V to 3.6V on A Port and 1.65V to 5.5V on B Port ( $V_{CCA} \leq V_{CCB}$ )
- $V_{CC}$  Isolation Feature – If Either  $V_{CC}$  Input is at GND, All Outputs are in the High-Impedance State
- OE Input Circuit Referenced to  $V_{CCA}$
- Low Power Consumption
- Latch-Up Performance Exceeds 100mA
- $\pm 4kV$  ESD Protection on B Ports

## Pin Configurations

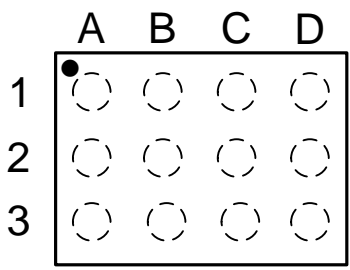
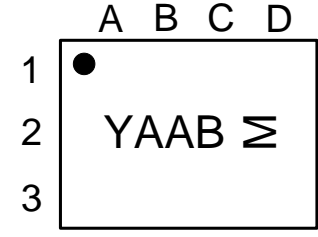
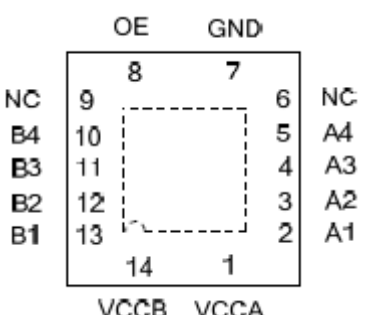
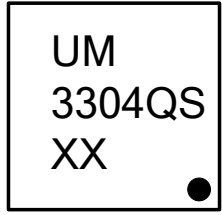
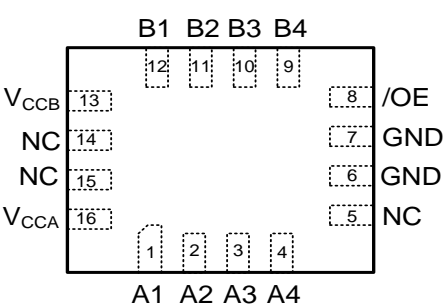
## Top View

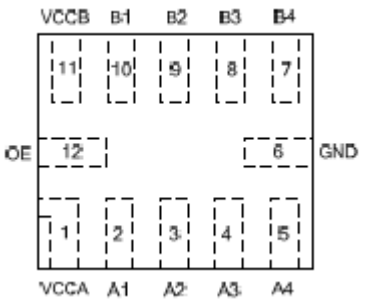
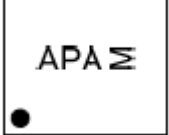
<p>(Top View)</p> 	 <p><b>M: Month Code</b> UM3304 CSP12 1.9×1.4</p>
<p>(Top View)</p> 	 <p><b>XX: Week Code</b> UM3304QS QFN14 3.5×3.5</p>
<p>(Top View)</p> 	 <p><b>XX: Week Code</b> UM3304QT QFN16 2.6×1.8</p>
<p>(Top View)</p> 	 <p><b>M: Month Code</b> UM3304QA QFN12 1.7×2.0</p>

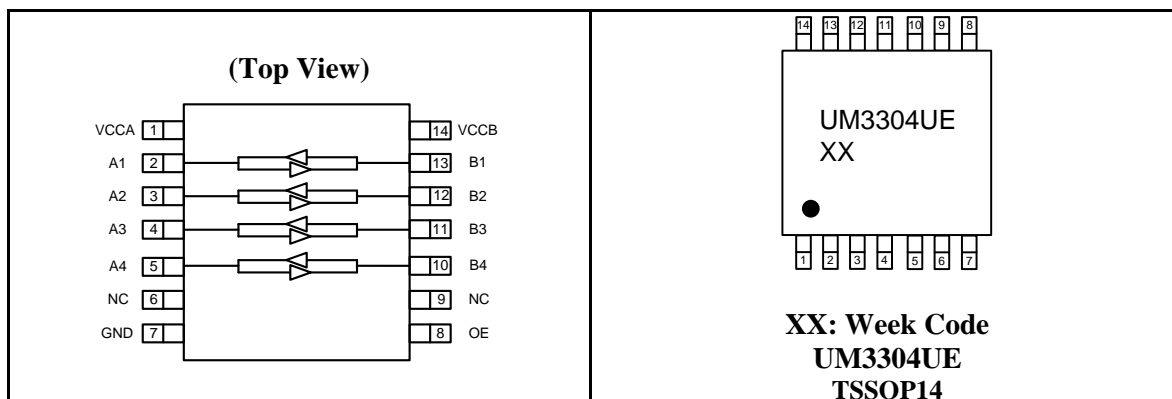

## Ball Mapping for UM3304

	A	B	C	D
1	A1	A2	A3	A4
2	V <sub>CCB</sub>	V <sub>CCA</sub>	OE	GND
3	B1	B2	B3	B4

Transparent Top View

## Pin Description

Pin Name	Function
V <sub>CCA</sub>	A-Port Supply Voltage. $1.2V \leq V_{CCA} \leq 3.6V$ and $V_{CCA} \leq V_{CCB}$
A1	Input/Output 1. Referenced to V <sub>CCA</sub>
A2	Input/Output 2. Referenced to V <sub>CCA</sub>
A3	Input/Output 3. Referenced to V <sub>CCA</sub>
A4	Input/Output 4. Referenced to V <sub>CCA</sub>
NC	Not Connected. (Except for UM3304)
GND	Ground
OE	3-State Output Enable. Pull OE low to place all outputs in 3-state mode. Referenced to V <sub>CCA</sub>
NC	Not Connected. (Except for UM3304)
B4	Input/Output 4. Referenced to V <sub>CCB</sub>
B3	Input/Output 3. Referenced to V <sub>CCB</sub>
B2	Input/Output 2. Referenced to V <sub>CCB</sub>
B1	Input/Output 1. Referenced to V <sub>CCB</sub>
V <sub>CCB</sub>	B-Port Supply Voltage. $1.65V \leq V_{CCB} \leq 5.5V$
NC	Not Connected. (Only for UM3304QT)
GND	Ground. (Only for UM3304QT)

## Ordering Information

Part Number	Packaging Type	Marking Code	Shipping Qty
UM3304	CSP12 1.9×1.4	YAAB	3000pcs/7Inch Tape & Reel
UM3304QS	QFN14 3.5×3.5	UM3304QS	3000pcs/13Inch Tape & Reel
UM3304QT	QFN16 2.6×1.8	3304	3000pcs/7Inch Tape & Reel
UM3304QA	QFN12 1.7×2.0	APA	3000pcs/7Inch Tape & Reel
UM3304UE	TSSOP14	UM3304UE	3000pcs/13Inch Tape & Reel

## Absolute Maximum Ratings (Note 1)

Over operating free-air temperature range (unless otherwise noted)

Symbol	Parameter	Value	Unit
$V_{CCA}$	Supply Voltage Range	-0.5 to +4.5	V
$V_{CCB}$	Supply Voltage Range	-0.5 to +6.5	V
$V_I$	Input Voltage Range	A ports	-0.5 to +4.5
		B ports	-0.5 to +6.5
$V_O$	Voltage Range Applied to Any Output in the High-Impedance or Power-Off State	A ports	-0.5 to +4.5
		B ports	-0.5 to +6.5
$V_O$	Voltage Range Applied to Any Output in the High or Low State (Note 2)	A ports	-0.5 to ( $V_{CCA}+0.5$ )
		B ports	-0.5 to ( $V_{CCB}+0.5$ )
$I_{IK}$	Input Clamp Current	$V_I < 0$	-50
$I_{OK}$	Output Clamp Current	$V_O < 0$	-50
$I_O$	Continuous Output Current		±50
	Continuous Current through $V_{CCA}$ , $V_{CCB}$ , or GND		±100
$T_{OP}$	Operating Temperature Range		-40 to +85
$T_J$	Junction Temperature		-40 to +165
$T_{STG}$	Storage Temperature Range		-65 to +150

Note 1. Stresses beyond those listed under "absolute maximum ratings" may cause permanent damage to the device. These are stress ratings only, and functional operation of the device at these or any other conditions beyond those indicated under "recommended operating conditions" is not implied. Exposure to absolute-maximum-rated conditions for extended periods may affect device reliability.

Note 2. The value of  $V_{CCA}$  and  $V_{CCB}$  are provided in the recommended operating conditions table.

## Recommended Operating Conditions (Note 1, 2)

Symbol	Parameter		V <sub>CCA</sub>	V <sub>CCB</sub>	Min	Max	Unit
V <sub>CCA</sub>	Supply Voltage				1.2	3.6	V
V <sub>CCB</sub>					1.65	5.5	V
V <sub>IH</sub>	High Level Input Voltage	Data Inputs	1.2V to 3.6V	1.65V to 5.5V	V <sub>CCI</sub> × 0.65 <sup>(Note3)</sup>	V <sub>CCI</sub>	V
		OE	1.2V to 3.6V	1.65V to 5.5V	V <sub>CCA</sub> × 0.65	5.5	V
V <sub>IL</sub>	Low Level Input Voltage	Data Inputs	1.2V to 3.6V	1.65V to 5.5V	0	V <sub>CCI</sub> × 0.35 <sup>(Note3)</sup>	V
		OE	1.2V to 3.6V	1.65V to 5.5V	0	V <sub>CCA</sub> × 0.35	V
V <sub>O</sub>	Voltage Range Applied to Any Output in the High-Impedance or Power-Off State	A-Port	1.2V to 3.6V	1.65V to 5.5V	0	3.6	V
		B-Port			0	5.5	
Δt/ΔV	Input Transition Rise or Fall Time	A-Port Inputs	1.2V to 3.6V	1.65V to 5.5V		40	ns/V
		B-Port Inputs	1.2V to 3.6V	1.65V to 3.6V		40	
				4.5V to 5.5V		30	

Note 1. The A and B sides of an unused data I/O pair must be held in the same state, i.e., both at V<sub>CCI</sub> or both at GND.

Note 2. V<sub>CCA</sub> must be less than or equal to V<sub>CCB</sub> and must not exceed 3.6 V.

Note 3. V<sub>CCI</sub> is the supply voltage associated with the input port.

## Thermal Information

Thermal Metric	UM3304	UM3304QS	UM3304QT	UM3304QA	UM3304UE	UNIT
R <sub>θJA</sub>	127.1	52.8	96.3	119.8	121	°C/W
R <sub>θJC</sub>	92.8	27.7	32.5	42.6	50	

**Electrical Characteristics (Note 1, 2)**

Over recommended operating free-air temperature range (unless otherwise noted)

Parameter	Test Conditions	V <sub>CCA</sub>	V <sub>CCB</sub>	T <sub>A</sub> =25 °C		-40 °C to 85 °C		Unit
				Min	Max	Min	Max	
V <sub>OHA</sub>	I <sub>OH</sub> =-20μA	1.2V		1.1		V <sub>CCA</sub> -0.4		V
		1.4V to 3.6V						
V <sub>OLA</sub>	I <sub>OL</sub> =20μA	1.2V		0.3		0.4		V
		1.4V to 3.6V						
V <sub>OHB</sub>	I <sub>OH</sub> =-20μA		1.65V to 5.5V			V <sub>CCB</sub> -0.4		V
V <sub>OLB</sub>	I <sub>OL</sub> =20μA		1.65V to 5.5V			0.4		V
I <sub>I</sub>	OE	V <sub>I</sub> =V <sub>CC1</sub> or GND	1.2V to 3.6V	1.65V to 5.5V	±1		±2	μA
I <sub>off</sub>	A Port	V <sub>I</sub> or V <sub>O</sub> =0 to 3.6V	0V	0V to 5.5V	±1		±2	μA
	B Port	V <sub>I</sub> or V <sub>O</sub> =0 to 5.5V	0V to 3.6V	0V	±1		±2	
I <sub>OZ</sub>	A or B Port	OE=GND	1.2V to 3.6V	1.65V to 5.5V	±1		±2	μA
I <sub>CCA</sub>	V <sub>I</sub> =V <sub>CC1</sub> or GND I <sub>O</sub> =0	1.2V	1.65V to 5.5V				5	μA
		1.4V to 3.6V	1.65V to 5.5V				5	
		3.6V	0V				2	
		0V	5.5V				-2	
I <sub>CCB</sub>	V <sub>I</sub> =V <sub>CC1</sub> or GND I <sub>O</sub> =0	1.2V	1.65V to 5.5V				5	μA
		1.4V to 3.6V	1.65V to 5.5V				5	
		3.6V	0V				-2	
		0V	5.5V				2	
I <sub>CCA</sub> +I <sub>CCB</sub>	V <sub>I</sub> =V <sub>CC1</sub> or GND I <sub>O</sub> =0	1.2V	1.65V to 5.5V				10	μA
		1.4V to 3.6V	1.65V to 5.5V				10	
I <sub>CCZA</sub>	V <sub>I</sub> =V <sub>CC1</sub> or GND I <sub>O</sub> =0, OE=GND	1.2V	1.65V to 5.5V				5	μA
		1.4V to 3.6V	1.65V to 5.5V				5	
I <sub>CCZB</sub>	V <sub>I</sub> =V <sub>CC1</sub> or GND I <sub>O</sub> =0, OE=GND	1.2V	1.65V to 5.5V				5	μA
		1.4V to 3.6V	1.65V to 5.5V				5	
C <sub>i</sub>	OE		1.2V to 3.6V	1.65V to 5.5V	3		4	pF
C <sub>iO</sub>	A Port		1.2V to 3.6V	1.65V to 5.5V	5		6	pF
	B Port				11		14	

 Note 1. V<sub>CC1</sub> is the supply voltage associated with the input port.

 Note 2. V<sub>CCO</sub> is the supply voltage associated with the output port.

**Switching Characteristics**
 $T_A=+25\text{ }^\circ\text{C}$ ,  $V_{CCA}=1.2\text{V}$ 

Parameter	From (Input)	To (Output)	$V_{CCB}=1.8\text{V}$	$V_{CCB}=2.5\text{V}$	$V_{CCB}=3.3\text{V}$	$V_{CCB}=5\text{V}$	Unit
			Typ	Typ	Typ	Typ	
$t_{pd}$	A	B	7	6	5.3	5.5	ns
	B	A	7.5	6.5	6	6	
$t_{en}$	OE	A	1	1	1	1	$\mu\text{s}$
		B	1	1	1	1	
$t_{dis}$	OE	A	18	16	14	14	ns
		B	19	17	15	15	
$t_{rA}, t_{fA}$	A Port Rise and Fall Time		5	5	5	5	ns
$t_{rB}, t_{fB}$	B Port Rise and Fall Time		2.5	1.5	1.2	1	ns
$t_{SK(O)}$	Channel-to-Channel		0.5	0.5	0.5	1.5	ns
Max Data Rate			20	20	20	20	Mbps

**Switching Characteristics**

 Over recommended operating free-air temperature range,  $V_{CCA}=1.5\text{V}\pm 0.1\text{V}$  (unless otherwise noted)

Parameter	From (Input)	To (Output)	$V_{CCB}=1.8\text{V}\pm 0.15\text{V}$		$V_{CCB}=2.5\text{V}\pm 0.2\text{V}$		$V_{CCB}=3.3\text{V}\pm 0.3\text{V}$		$V_{CCB}=5\text{V}\pm 0.5\text{V}$		Unit
			Min	Max	Min	Max	Min	Max	Min	Max	
$t_{pd}$	A	B	2	15	1.2	11	1.1	10	1	10	ns
	B	A	1	15	0.9	12	0.5	12	0.3	13	
$t_{en}$	OE	A		1		1		1		1	$\mu\text{s}$
		B		1		1		1		1	
$t_{dis}$	OE	A	6	30	5.5	28	5.5	25	5.5	23	ns
		B	5.5	30	5	25	5	20	5	20	
$t_{rA}, t_{fA}$	A Port Rise and Fall Time		1.5	5.0	1.5	5.0	1.5	5.0	1.5	5.0	ns
$t_{rB}, t_{fB}$	B Port Rise and Fall Time		0.9	4.5	0.6	3.5	0.5	3	0.4	2.5	ns
$t_{SK(O)}$	Channel-to-Channel			0.5		0.5		0.5		0.5	ns
Max Data Rate			40		40		40		40		Mbps

**Switching Characteristics**

Over recommended operating free-air temperature range,  $V_{CCA}=1.8V \pm 0.15V$  (unless otherwise noted)

Parameter	From (Input)	To (Output)	$V_{CCB}=1.8V \pm 0.15V$		$V_{CCB}=2.5V \pm 0.2V$		$V_{CCB}=3.3V \pm 0.3V$		$V_{CCB}=5V \pm 0.5V$		Unit
			Min	Max	Min	Max	Min	Max	Min	Max	
$t_{pd}$	A	B	1.6	10	1.4	9	1.3	7	1.2	6.5	ns
	B	A	1.5	12	1.3	8.5	1	8	0.9	8	
$t_{en}$	OE	A		1		1		1		1	$\mu s$
		B		1		1		1		1	
$t_{dis}$	OE	A	6	34	5.5	23	5	20	5	17.6	ns
		B	5.5	33	4.5	22	4.2	16.8	4.4	16.3	
$t_{rA}, t_{fA}$	A Port Rise and Fall Time		1	4.2	1.1	4.0	1.1	4.0	1.1	4.0	ns
$t_{rB}, t_{fB}$	B Port Rise and Fall Time		0.9	4	0.6	3.2	0.5	2.8	0.4	2.8	ns
$t_{SK(O)}$	Channel-to-Channel			0.5		0.5		0.5		0.5	ns
Max Data Rate			60		60		60		60		Mbps

**Switching Characteristics**

Over recommended operating free-air temperature range,  $V_{CCA}=2.5V \pm 0.2V$  (unless otherwise noted)

Parameter	From (Input)	To (Output)	$V_{CCB}=2.5V \pm 0.2V$		$V_{CCB}=3.3V \pm 0.3V$		$V_{CCB}=5V \pm 0.5V$		Unit
			Min	Max	Min	Max	Min	Max	
$t_{pd}$	A	B	1.1	6.5	1	5.2	0.9	5	ns
	B	A	1.2	6.6	1.1	5.1	0.9	4.4	
$t_{en}$	OE	A		1		1		1	$\mu s$
		B		1		1		1	
$t_{dis}$	OE	A	5.0	23	4.6	15.2	4.6	13	ns
		B	4.4	22	3.8	16	3.9	13.3	
$t_{rA}, t_{fA}$	A Port Rise and Fall Time		0.8	3	0.8	3	0.8	3	ns
$t_{rB}, t_{fB}$	B Port Rise and Fall Time		0.7	2.7	0.5	2.8	0.4	2.7	ns
$t_{SK(O)}$	Channel-to-Channel			0.5		0.5		0.5	ns
Max Data Rate			100		100		100		Mbps



## Switching Characteristics

Over recommended operating free-air temperature range,  $V_{CCA}=3.3V \pm 0.3V$  (unless otherwise noted)

Parameter	From (Input)	To (Output)	$V_{CCB}=3.3V \pm 0.3V$		$V_{CCB}=5V \pm 0.5V$		Unit
			Min	Max	Min	Max	
$t_{pd}$	A	B	0.9	5	0.8	4	ns
	B	A	1	5.1	0.9	4	
$t_{en}$	OE	A		1		1	$\mu s$
		B		1		1	
$t_{dis}$	OE	A	5	15	4	13	ns
		B	4	16	3.4	13.8	
$t_{rA}, t_{fA}$	A Port Rise and Fall Time		0.7	2.5	0.7	2.5	ns
$t_{rB}, t_{fB}$	B Port Rise and Fall Time		0.5	2.1	0.4	2.8	ns
$t_{SK(O)}$	Channel-to-Channel			0.5		0.5	ns
Max Data Rate			100		100		Mbps

## Operating Characteristics

$T_A=+25^\circ C$

Parameter		Test Conditions	$V_{CCB}$						Unit	
			5V	1.8V	1.8V	1.8V	2.5V	5V		3.3V to 5V
			$V_{CCA}$							
			1.2V	1.2V	1.5V	1.8V	2.5V	2.5V		3.3V
			Typ	Typ	Typ	Typ	Typ	Typ	Typ	
$C_{pdA}$	A-Port Input B-Port Output	$C_L=0,$ $f=10MHz,$ $t_r=t_f=1ns,$ $OE=V_{CCA}$	9	10	10	10	10	10	10	pF
	B-Port Input A-Port Output		12	11	11	11	11	11	11	
$C_{pdB}$	A-Port Input B-Port Output		35	28	28	29	3.0	30	30	
	B-Port Input A-Port Output		27	19	19	19	20	21	23	
$C_{pdA}$	A-Port Input B-Port Output	$C_L=0,$ $f=10MHz,$ $t_r=t_f=1ns,$ $OE=GND$	0.01	0.01	0.01	0.01	0.01	0.01	0.01	pF
	B-Port Input A-Port Output		0.01	0.01	0.01	0.01	0.01	0.01	0.01	
$C_{pdB}$	A-Port Input B-Port Output		0.01	0.01	0.01	0.01	0.01	0.01	0.03	
	B-Port Input A-Port Output		0.01	0.01	0.01	0.01	0.01	0.01	0.05	

## Applications Information

UM3304/UM3304QS/UM3304QT/UM3304QA/UM3304UE ESD protected level translator provides level shifting necessary to allow data transfer in a multi-voltage system. Externally applied voltages,  $V_{CCA}$  and  $V_{CCB}$  set the logic levels on either side of device. A low voltage signal present on  $V_{CCA}$  side of the device appears as a high voltage logic signal on the  $V_{CCB}$  side of the device, and vice-versa.

## Block Diagram

The UM3304/UM3304QS/UM3304QT/UM3304QA/UM3304UE (block diagram see Figure 1) does not require a direction-control signal to control the direction of data flow from A to B or from B to A. In a dc state, the output drivers of the UM3304/UM3304QS/UM3304QT/UM3304QA/UM3304UE can maintain a high or low, but are designed to be weak, so that they can be overdriven by an external driver when data on the bus starts flowing to the opposite direction.

The output one shot detects rising or falling edges on the A or B ports. During a rising edge, the one shot turns on the PMOS transistors (T1, T3) for a short duration, which speeds up the low-to-high transition. Similarly, during a falling edge, the one shot turns on the NMOS transistors (T2, T4) for a short duration, which speeds up the high-to-low transition.

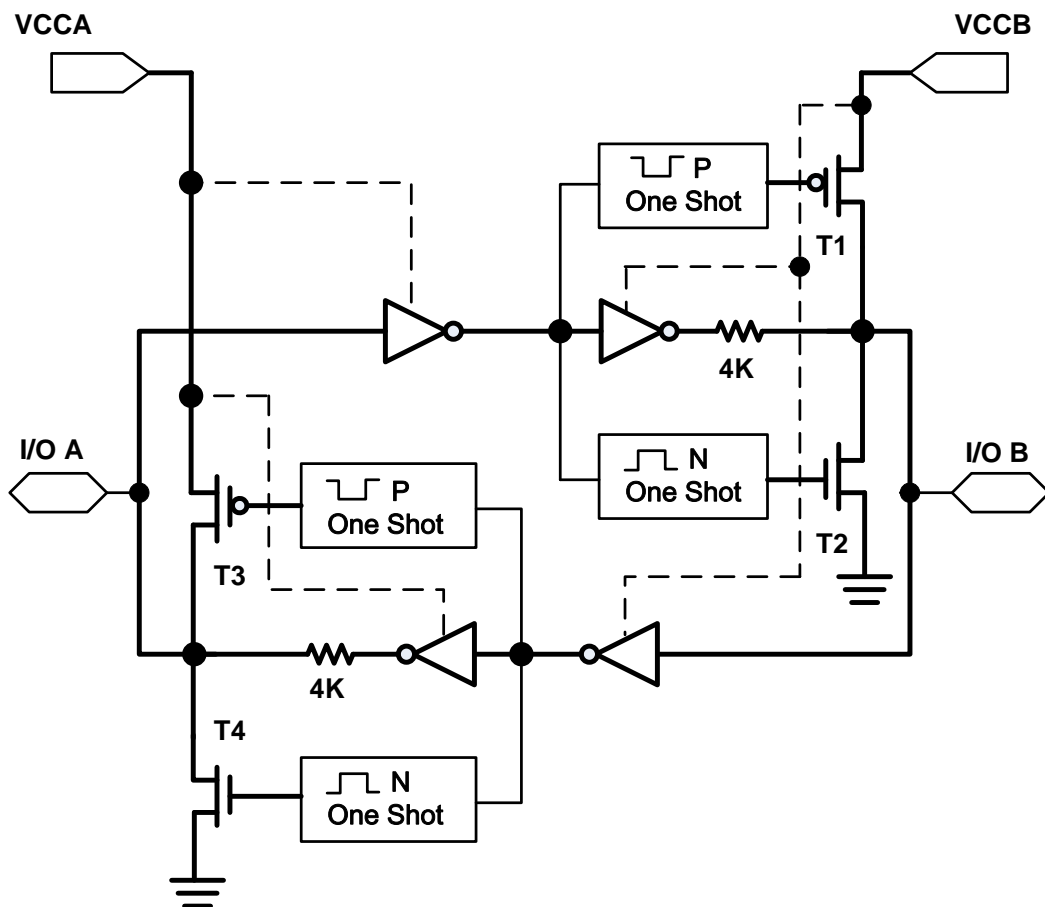
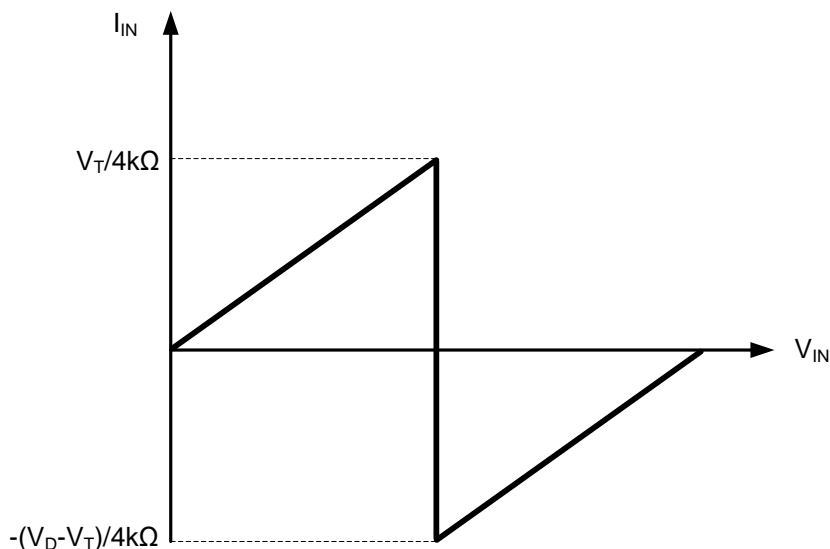

Figure 1 Block Diagram of UM3304/UM3304QS/UM3304QT/UM3304QA/UM3304UE I/O Cell

## Input Driver Requirements

Typical  $I_{IN}$  vs.  $V_{IN}$  characteristics of the UM3304/UM3304QS/UM3304QT/UM3304QA/UM3304UE are shown in Figure 2. For proper operation, the device driving the data I/Os of the UM3304/UM3304QT must have drive strength of at least  $\pm 2\text{mA}$ .



A:  $V_T$  is the input threshold voltage of the UM3304/UM3304QS/UM3304QT/UM3304QA/UM3304UE (typical  $V_{CC}/2$ ).  
 B:  $V_D$  is the supply voltage of the external driver.

**Figure 2 Typical  $I_{IN}$  vs.  $V_{IN}$  Curve**

## Power Up

During operation, ensure that  $V_{CCA} \leq V_{CCB}$  at all times. During power-up sequencing,  $V_{CCA} \geq V_{CCB}$  does not damage the device, so any power supply can be ramped up first. The UM3304/UM3304QS/UM3304QT/UM3304QA/UM3304UE has circuitry that disables all output ports when either  $V_{CC}$  is switched off ( $V_{CCA/B} = 0\text{V}$ ).

## Enable and Disable

The UM3304/UM3304QS/UM3304QT/UM3304QA/UM3304UE has an OE input that is used to disable the device by setting OE=low, which places all I/Os in the high-impedance (Hi-Z) state. The disable time ( $t_{dis}$ ) indicates the delay between when OE goes low and when the outputs actually get disabled (Hi-Z). The enable time ( $t_{en}$ ) indicates the amount of time the user must allow for the one-shot circuitry to become operational after OE is taken high.

## Pull-up or Pull-down Resistors on I/O Lines

The UM3304/UM3304QS/UM3304QT/UM3304QA/UM3304UE is designed to drive capacitive loads of up to 50pF. The output drivers of the device have low dc drive strength. External pull-up or pull-down resistors need higher than 50k $\Omega$ . For the same reason, the UM3304/UM3304QS/UM3304QT/UM3304QA/UM3304UE should not be used in open-drain system, such as I<sup>2</sup>C or 1-wire system.

## Typical Operating Circuit

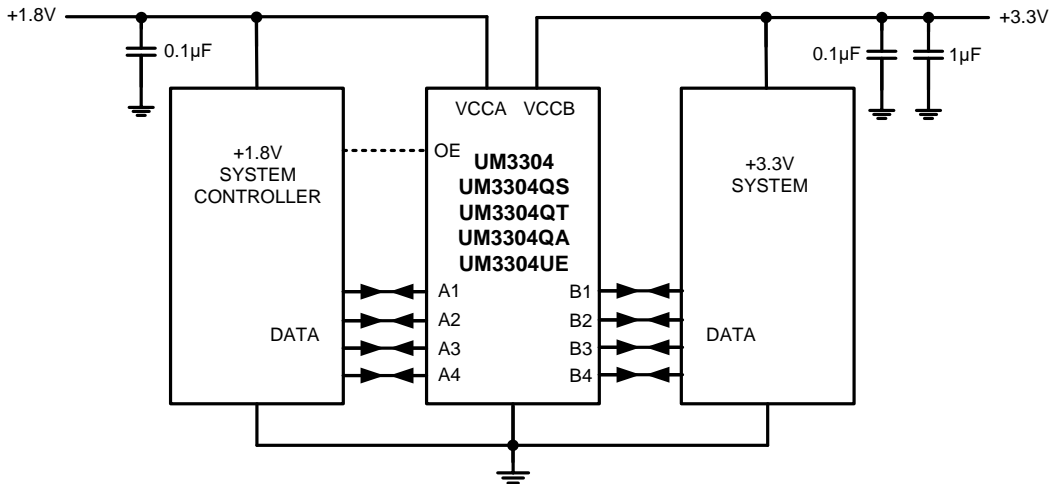

**Figure 3 Typical Operating Circuit**

## Test Circuits

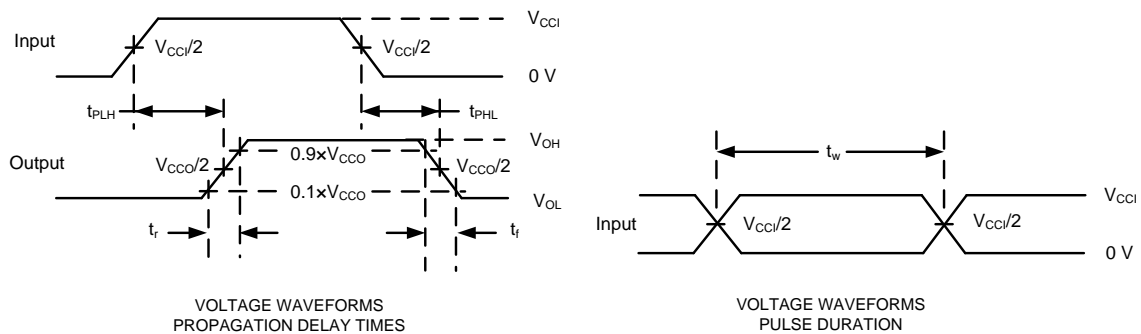
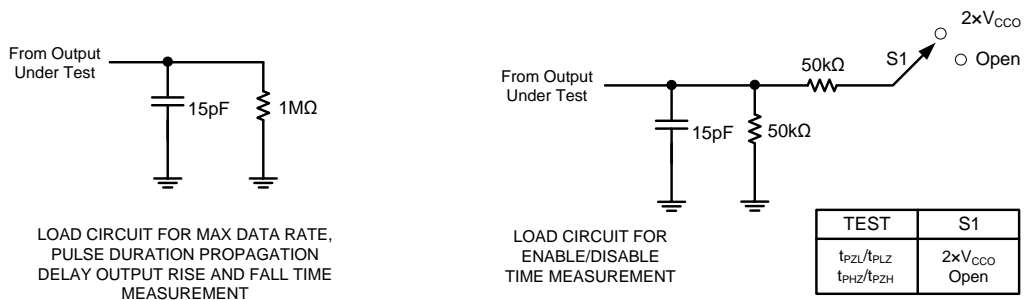

- A.  $C_L$  includes probe and jig capacitance.
- B. All input pulses are supplied by generators having the following characteristics:  $PRR \leq 10\text{MHz}$ ,  $Z_0 = 50\Omega$ ,  $dv/dt \geq 1\text{V/ns}$ .
- C. The outputs are measured one at a time, with one transition per measurement.
- D.  $t_{PLH}$  and  $t_{PHL}$  are the same as  $t_{pd}$ .
- E.  $V_{CCI}$  is the  $V_{CC}$  associated with the input port.
- F.  $V_{CCO}$  is the  $V_{CC}$  associated with the output port.
- G. All parameters and waveforms are not applicable to all devices.

**Figure 4 Load Circuits and Voltage Waveforms**

## Package Information

### UM3304 CSP12 1.9×1.4

#### Outline Drawing

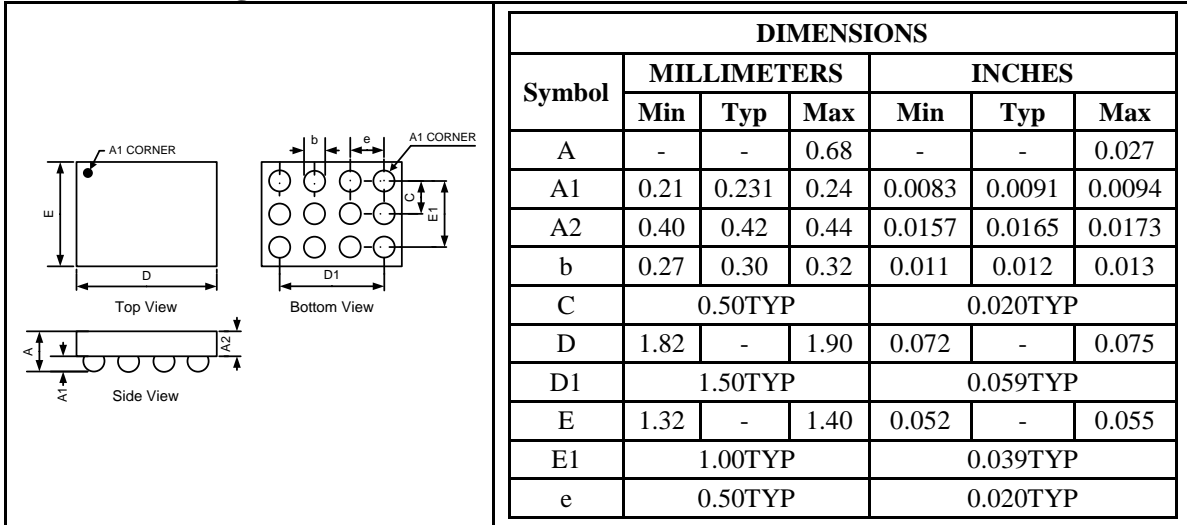

#### Land Pattern

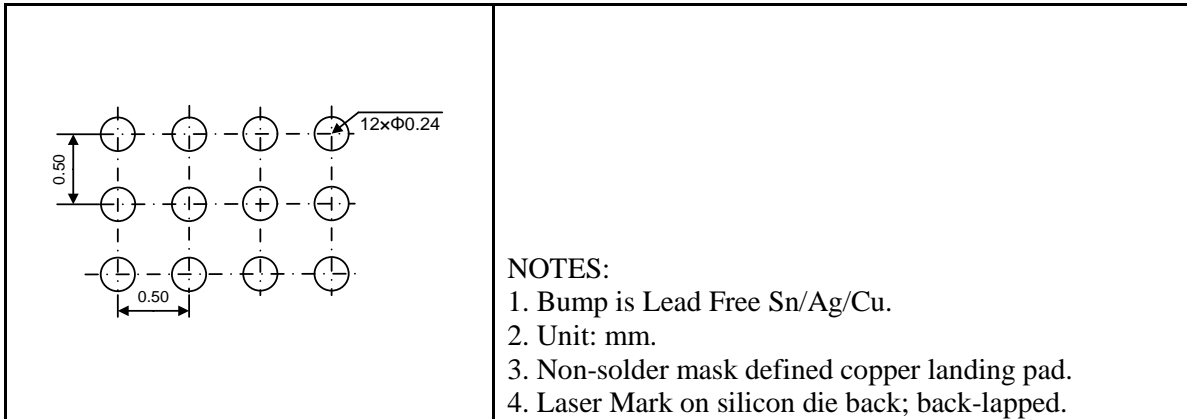

#### Tape and Reel Orientation

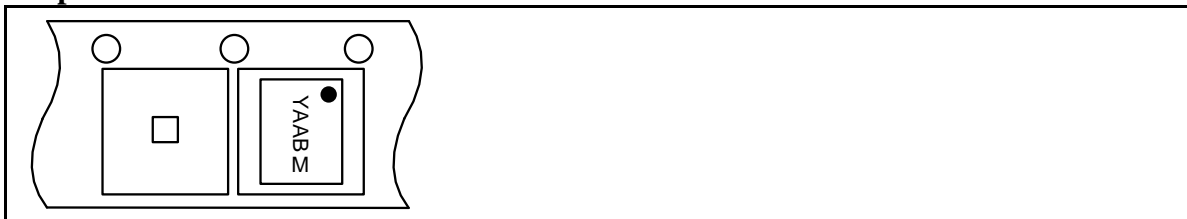

## UM3304QS QFN14 3.5×3.5

### Outline Drawing

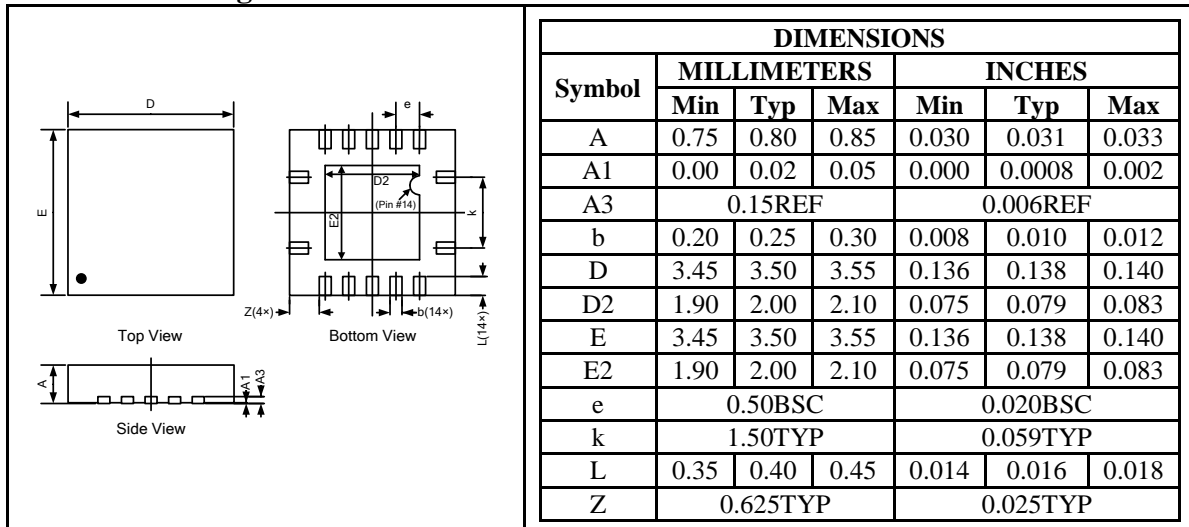

### Land Pattern

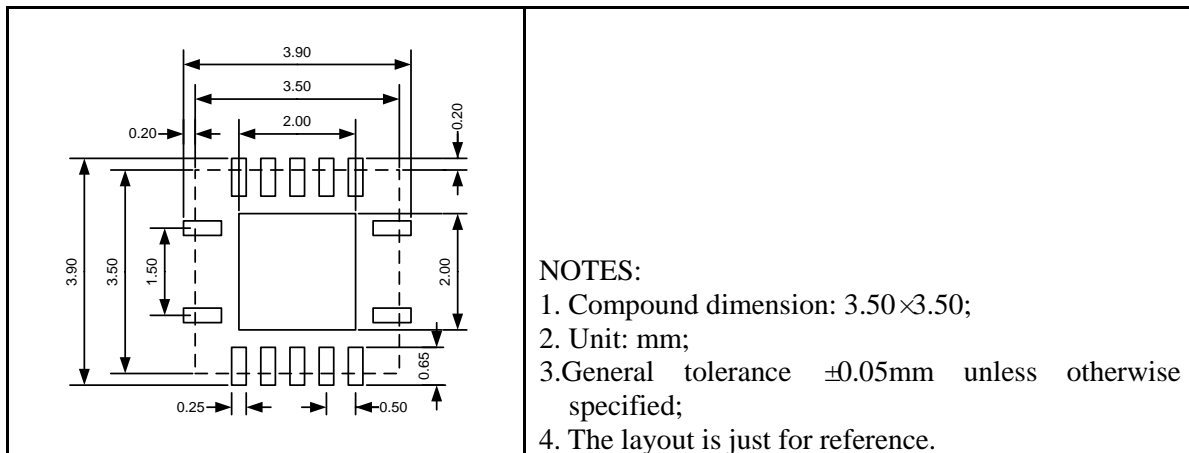

### Tape and Reel Orientation



## UM3304QT QFN16 2.6×1.8

### Outline Drawing

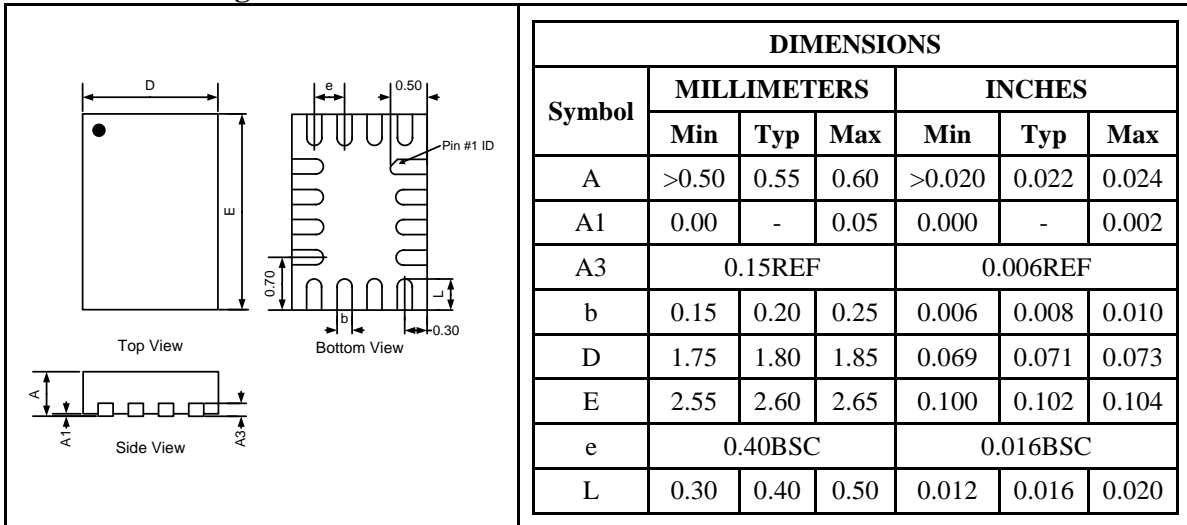

### Land Pattern

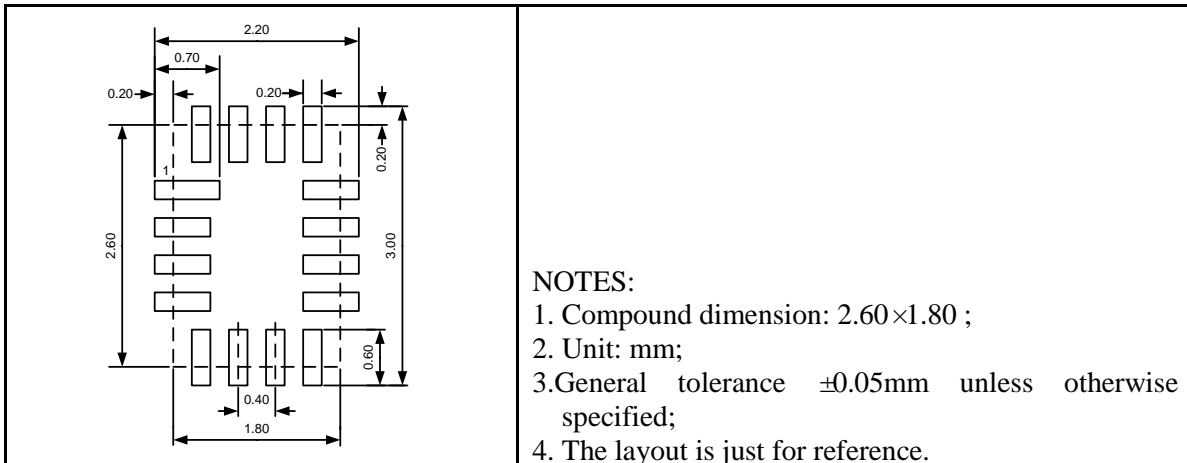

### Tape and Reel Orientation

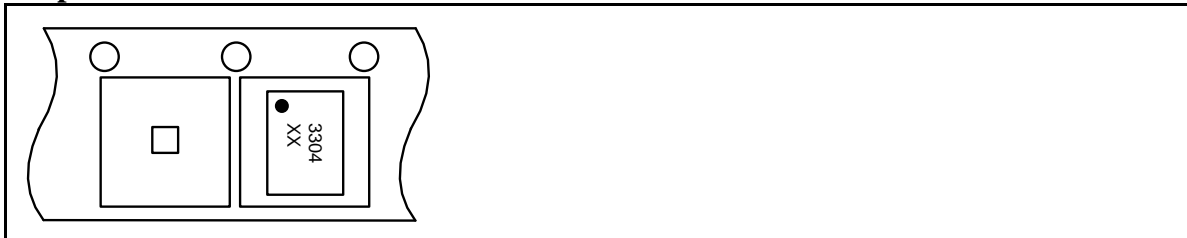

## UM3304QA QFN12 1.7×2.0

### Outline Drawing

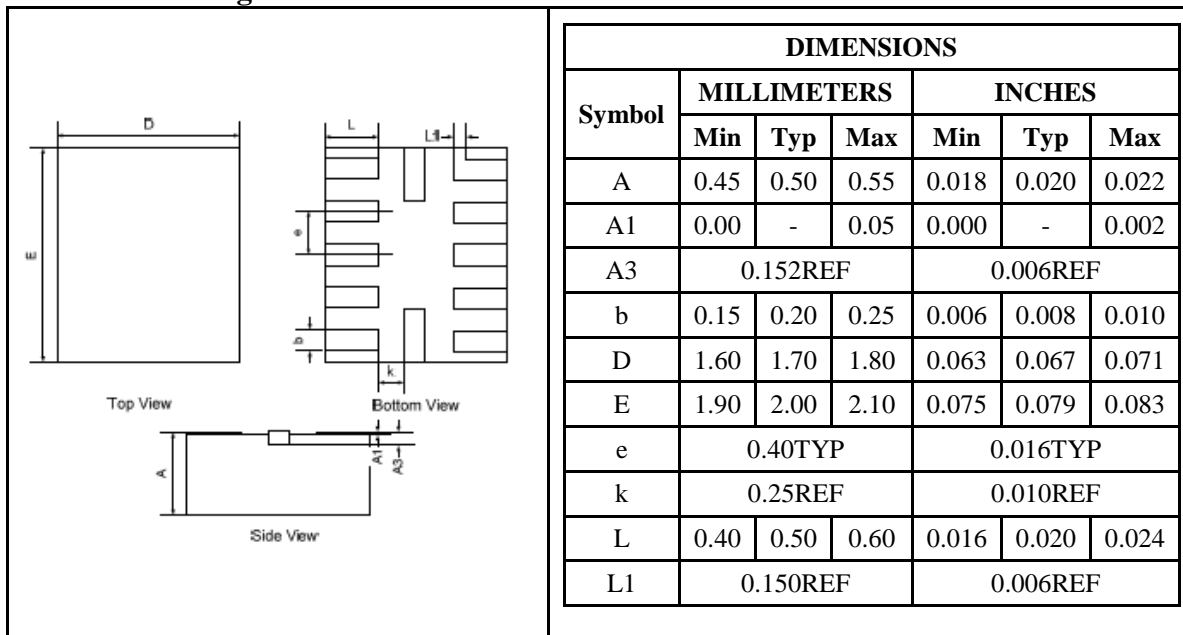

### Land Pattern

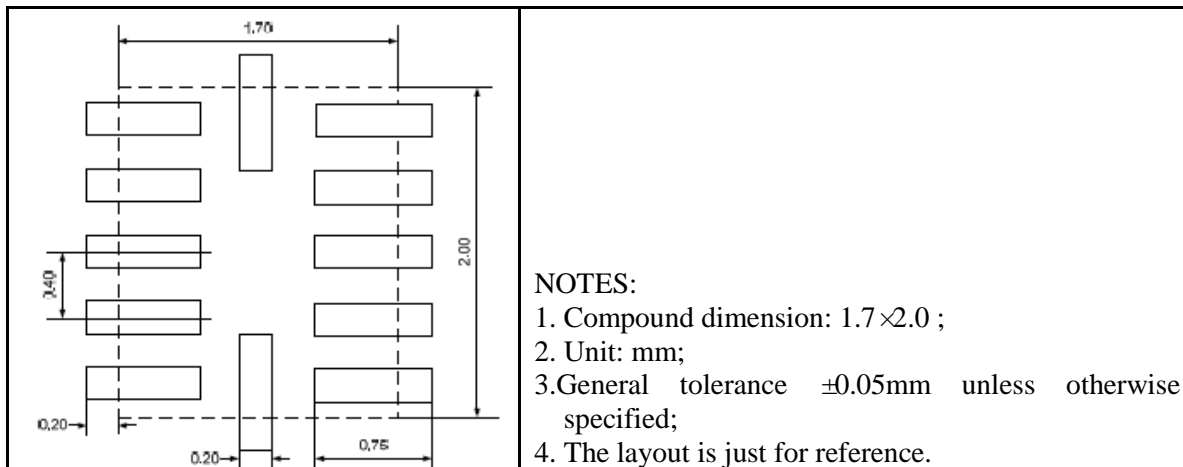

### Tape and Reel Orientation





## UM3304UE: TSSOP14

### Outline Drawing

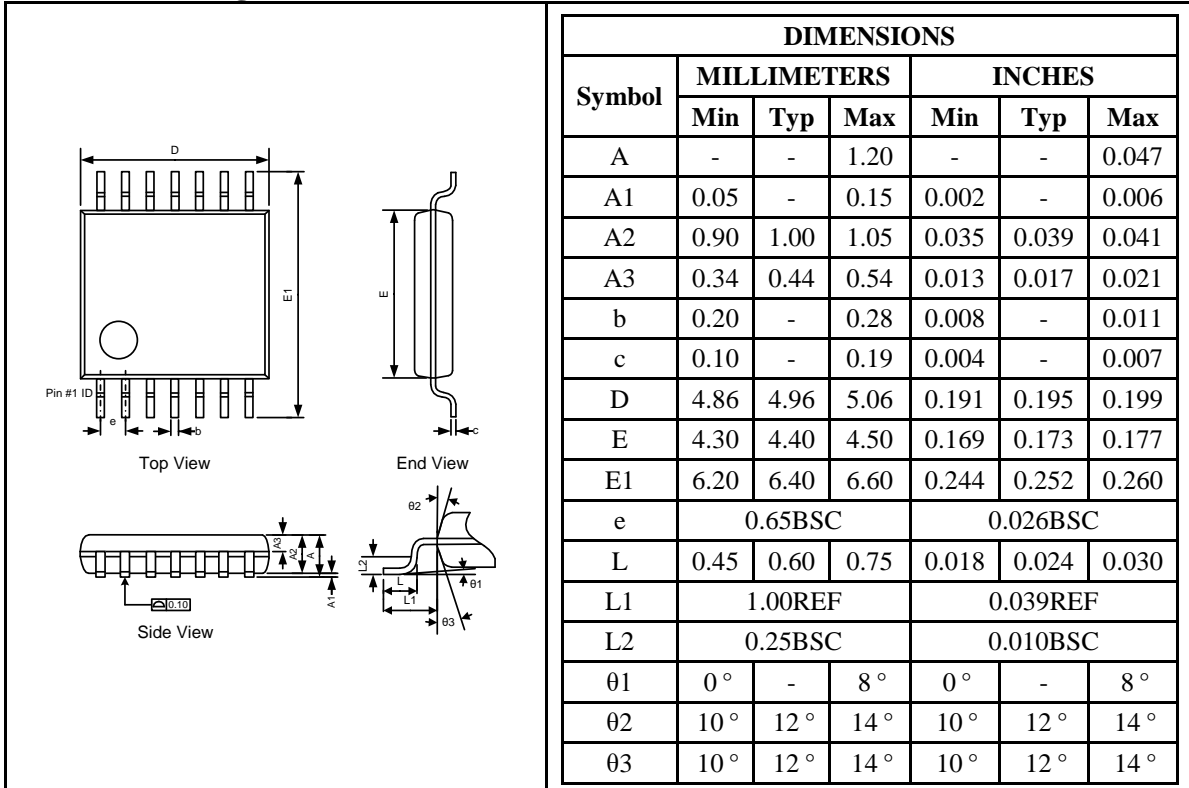

### Land Pattern

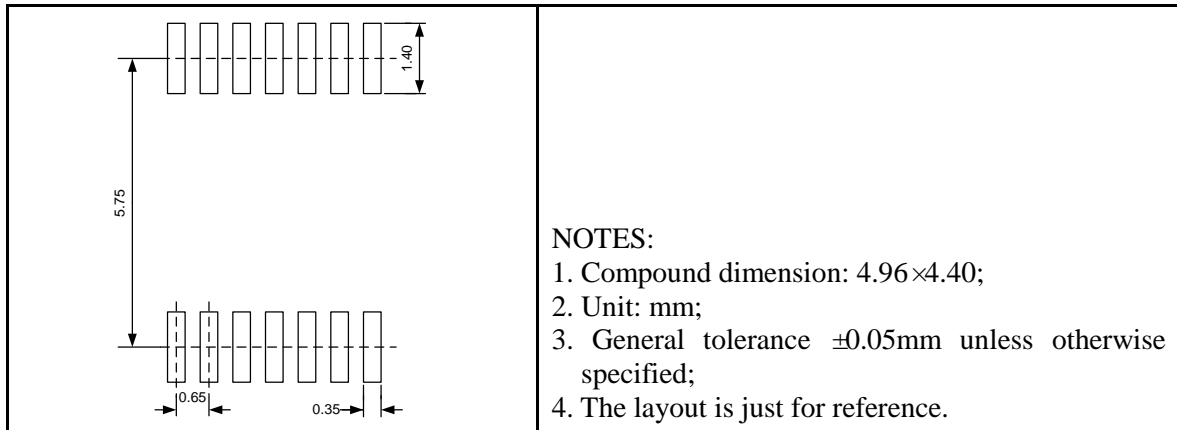

### Tape and Reel Orientation

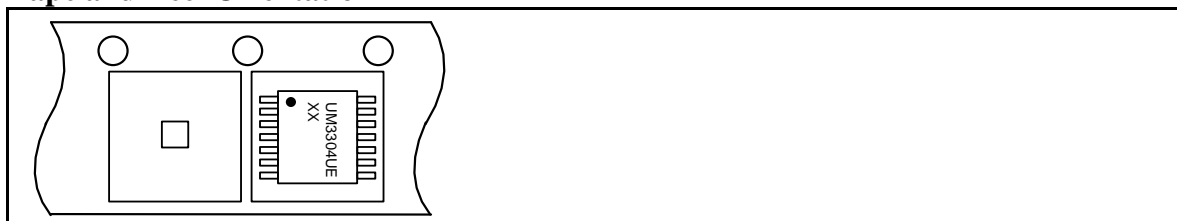

---

## **GREEN COMPLIANCE**

Union Semiconductor is committed to environmental excellence in all aspects of its operations including meeting or exceeding regulatory requirements with respect to the use of hazardous substances. Numerous successful programs have been implemented to reduce the use of hazardous substances and/or emissions.

All Union components are compliant with the RoHS directive, which helps to support customers in their compliance with environmental directives. For more green compliance information, please visit:

[http://www.union-ic.com/index.aspx?cat\\_code=RoHSDeclaration](http://www.union-ic.com/index.aspx?cat_code=RoHSDeclaration)

## **IMPORTANT NOTICE**

The information in this document has been carefully reviewed and is believed to be accurate. Nonetheless, this document is subject to change without notice. Union assumes no responsibility for any inaccuracies that may be contained in this document, and makes no commitment to update or to keep current the contained information, or to notify a person or organization of any update. Union reserves the right to make changes, at any time, in order to improve reliability, function or design and to attempt to supply the best product possible.



Union Semiconductor, Inc

Add: Unit 606, No.570 Shengxia Road, Shanghai 201210

Tel: 021-51093966

Fax: 021-51026018

Website: [www.union-ic.com](http://www.union-ic.com)

## X-ON Electronics

Largest Supplier of Electrical and Electronic Components

*Click to view similar products for [Translation - Voltage Levels](#) category:*

*Click to view products by [Union manufacturer](#):*

Other Similar products are found below :

[NLSX4373DMR2G](#) [NLSX5012MUTAG](#) [NLSX0102FCT1G](#) [NLSX0102FCT2G](#) [PCA9306FMUTAG](#) [MC100EPT622MNG](#)  
[NLSX3014MUTAG](#) [NLSX5011MUTCG](#) [NLVSX4373MUTAG](#) [NB3U23CMNTAG](#) [NLSX3013BFCT1G](#) [NLSX3012DMR2G](#)  
[NLA9306MU3TCG](#) [NVT2001GMZ](#) [PI4ULS3V504AZMAEX](#) [74AVCH1T45FW3-7](#) [NLSX5011AMUTAG](#) [74AXP1T34GWH](#)  
[ST2149BQTR](#) [MC100ELT21DR2G](#) [MC100LVELT22MNRG](#) [MC10ELT20DR2G](#) [MC10EPT20MNR4G](#) [MC14504BFELG](#)  
[NLSV4T3234FCT1G](#) [NLSX3378BFCT1G](#) [RS0104YQ](#) [RS0102YVS8](#) [RS0202XM](#) [RS4T245XTSS16](#) [RS1T45XH6](#) [RS0101YUTDV6](#)  
[RS8T245XTSS24-Q1](#) [UM3208QA](#) [UM3208H](#) [UM3212V8](#) [UM3304UE](#) [UM3304](#) [UM3304QT](#) [UM3202H](#) [UM3301DA](#) [UM3308](#)  
[AIPTS0108TA20.TR](#) [CD4049UBMT/TR](#) [RS0102YUTDS8](#) [RS0204YUTQH12](#) [RS0102YTDB8](#) [RS0101YC6](#) [RS0204YQ](#) [AW39114FOR](#)