

**+3.3V Low Power, ±15kV ESD-Protected, Fail-Safe,
RS-422 Transceivers**

UM3488EESA SOP8
UM3488EEPA DIP8
UM3491EESE SOP14
UM3491EEPE DIP14

General Description

The UM3488/UM3491 is ±15kV electrostatic discharge (ESD)-protected, high-speed transceivers for RS-422 communication that contain one driver and one receiver. The UM3491 contains an additional receiver and driver enable control. The device features fail-safe circuitry, which guarantees a logic-high receiver output when the receiver inputs are open or shorted. This means that the receiver output will be a logic high if all transmitters on a terminated bus are disabled (high impedance). The UM3488/UM3491 allows transmit speeds up to 10Mbps. The device features enhanced ESD protection. All transmitter outputs and receiver inputs are protected to ±15kV using the Human Body Model.

These transceivers typically draw 180µA of supply current when unloaded, or when fully loaded with the drivers disabled.

The device has a 1/8-unit-load receiver input impedance that allows up to 256 transceivers on the bus. The UM3488/UM3491 is intended for full-duplex communications.

Applications

- RS-422 Communications
- Level Translators
- Transceivers for EMI-Sensitive Applications
- Industrial-Control Local Area Networks

Features

- ESD Protection for RS-422 I/O Pins ±15kV, Human Body Model
- True Fail-Safe Receiver while Maintaining EIA/TIA-422 Compatibility
- Maximum Data Rate up to 10Mbps
- Error-Free Data Transmission
- 1nA Low-Current Shutdown Mode (UM3491)
- Allow up to 256 Transceivers on the Bus

Selector Guide

Part Number	Half/Full Duplex	Data Rate (Mbps)	Slew-Rate Limited	Low-Power Shutdown	Receiver/Driver Enable	Quiescent Current (µA)	Transceivers On Bus	Pin Count
UM3488	full	10	Yes	No	No	180	256	8
UM3491	full	10	Yes	Yes	Yes	180	256	14

Ordering Information

Part Number	Temperature Range	Packaging Type	Shipping Qty
UM3488EESA	-40°C to +85°C	SOP8	3000pcs/13 Inch Tape & Reel
UM3488EEPA	-40°C to +85°C	DIP8	50pcs/Tube
UM3491EESE	-40°C to +85°C	SOP14	2500pcs/13 Inch Tape & Reel
UM3491EEPE	-40°C to +85°C	DIP14	25pcs/Tube

Pin Configurations

Top View

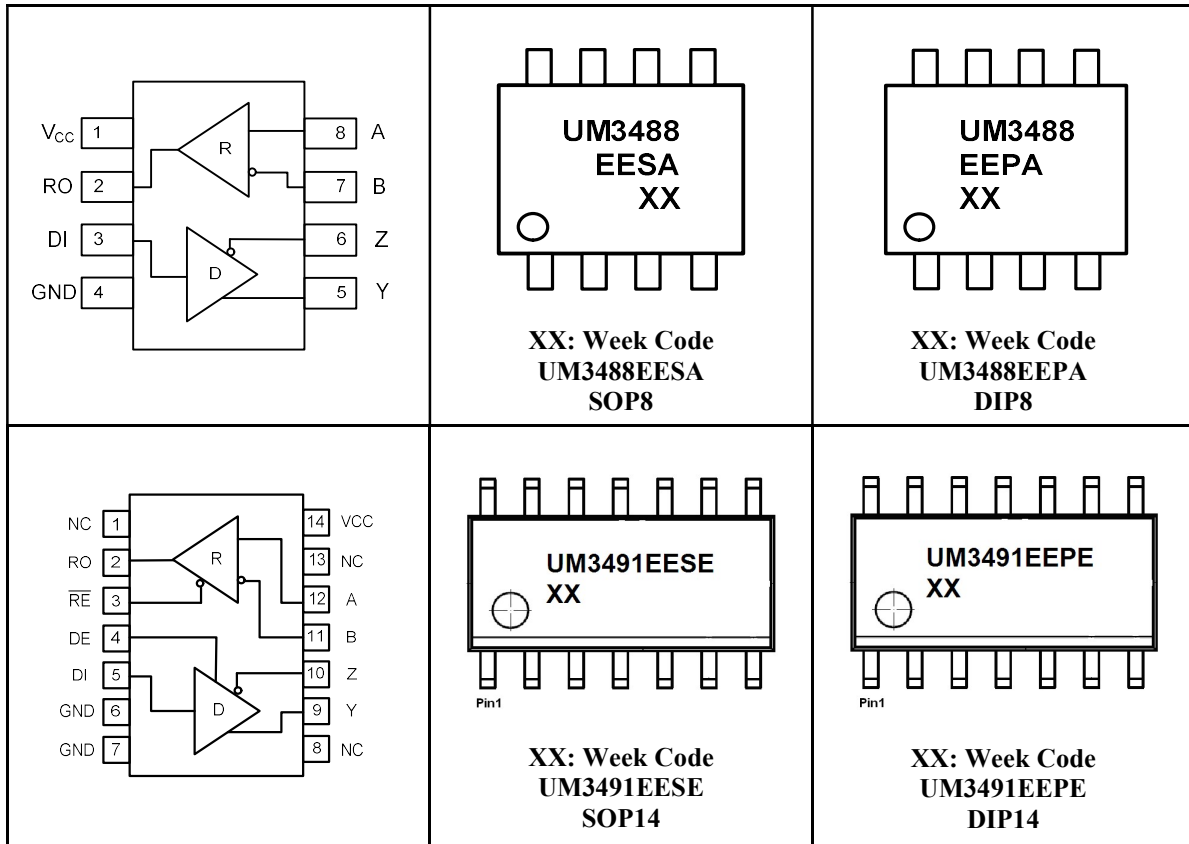

Absolute Maximum Ratings

Symbol	Parameter	Value	Unit
V _{CC}	Supply Voltage	+7	V
	Control Input Voltage (RE, DE)	-0.3V to (V _{CC} + 0.3V)	V
	Driver Input Voltage (DI)	-0.3V to (V _{CC} + 0.3V)	V
	Driver Output Voltage (Y, Z)	-7.5 to +12.5	V
	Receiver Input Voltage (A, B)	-7.5 to +12.5	V
	Receiver Output Voltage (RO)	-0.3V to (V _{CC} + 0.3V)	V
P _D	8-Pin SO (derate 9.09mW/°C above +70°C)	520	mW
	8-Pin Plastic DIP (derate 9.09mW/°C above +70°C)	727	
	14-Pin Plastic DIP (derate 10.0mW/°C above +70°C)	800	
	14-Pin SO (derate 8.33mW/°C above +70°C)	667	
T _A	Ambient Temperature	-40 to +85	°C
T _J	Junction Temperature	-40 to +150	°C
T _{STG}	Storage Temperature Range	-65 to +150	°C
T _L	Lead Temperature for Soldering 10 seconds	+300	°C

Thermal Information

Symbol	Thermal Metric	Value	UNIT
R _{θJA}	Junction to Ambient Thermal Resistance	SOP8	110
		SOP14	85
		DIP8	87
		DIP14	63
R _{θJC}	Junction to Case Thermal Resistance	SOP8	54
		SOP14	42
		DIP8	43
		DIP14	37

DC Electrical Characteristics

(V_{CC} = +3.3V ± 5%, T_A = T_{MIN} to T_{MAX}, unless otherwise noted. Typical values are at V_{CC} = +3.3V and T_A = +25°C.) (Note 1)

Parameter	Symbol	Test Conditions	Min	Typ	Max	Unit	
DRIVER							
Differential Driver Output (No Load)	V _{OD1}	Figure 3			V _{CC}	V	
Differential Driver Output	V _{OD2}	Figure 3, R = 50Ω	1.8		V _{CC}	V	
Differential Driver Output	V _{OD3}	Figure 3, R = 27Ω	1.3		V _{CC}	V	
Change-in-Magnitude of Differential Output Voltage (Note 2)	ΔV _{OD}	Figure 3, R = 50Ω			0.2	V	
Driver Common-Mode Output Voltage	V _{OC}	Figure 3, R = 50Ω			3.0	V	
Input High Voltage	V _{IH}	DE, DI, \overline{RE}	2.0			V	
Input Low Voltage	V _{IL}	DE, DI, \overline{RE}			0.8	V	
DI Input Hysteresis	V _{HYS}			100		mV	
Driver Short-Circuit Output Current (Note 3)	V _{OD1}	-7V ≤ V _{OUT} ≤ V _{CC}	-250			mA	
		0V ≤ V _{OUT} ≤ 12V			250		
RECEIVER							
Input Current (A and B)	I _{IN}	DE = GND, V _{CC} = GND or 3.465V	V _{IN} = 12V			125	μA
			V _{IN} = -7V			-75	
Receiver Differential Threshold Voltage	V _{TH}	-7V ≤ V _{CM} ≤ 12V	-200	-125	-50	mV	

Receiver Input Hysteresis	ΔV_{TH}			25		mV	
Receiver Output High Voltage	V_{OH}	$I_O = -4mA, V_{ID} = -50mV$	$V_{CC} - 0.4$			V	
Receiver Output Low Voltage	V_{OL}	$I_O = 4mA, V_{ID} = -200mV$			0.4	V	
Three-State Output Current at Receiver	I_{OZR}	$0.4V \leq V_O \leq 2.4V$			± 1	μA	
Receiver Input Resistance	R_{IN}	$-7V \leq V_{CM} \leq 12V$	96			$k\Omega$	
Receiver Output Short Circuit Current	I_{OSR}	$0V \leq V_{RO} \leq V_{CC}$	± 7		± 95	mA	
SUPPLY CURRENT							
Supply Current	I_{CC}	No load, DE =DI=GND or V_{CC}	$\overline{RE} = V_{CC}$		20	60	μA
			$\overline{RE} = GND$		180	300	
Supply Current in Shutdown Mode	I_{SHDN}	DE = GND, $V_{\overline{RE}} = V_{CC}$			0.001	10	μA
ESD Protection for Y, Z, A, B		Human Body Model			± 15		kV

Note 1: All currents into the device are positive; all currents out of the device are negative. All voltages are referred to device ground unless otherwise noted.

Note 2: ΔV_{OD} and ΔV_{OC} are the changes in V_{OD} and V_{OC} , respectively, when the DI input changes state.

Note 3: Maximum current level applies to peak current just prior to foldback-current limiting; minimum current level applies during current limiting.

Switching Characteristics

($V_{CC} = +3.3V \pm 5\%$, $T_A = T_{MIN}$ to T_{MAX} , unless otherwise noted. Typical values are at $V_{CC} = +3.3V$ and $T_A = +25^\circ C$.)

Parameter	Symbol	Test Conditions	Min	Typ	Max	Unit
Driver Input-to-Output	t_{DPLH}	Figures 5 and 7, $R_{DIFF} = 54\Omega$, $C_{L1} = C_{L2} = 100pF$	10	30	60	ns
	t_{DPHL}		10	30	60	
Driver Output Skew $ t_{DPLH} - t_{DPHL} $	t_{DSKEW}	Figures 5 and 7, $R_{DIFF} = 54\Omega$, $C_{L1} = C_{L2} = 100pF$		10	25	ns
Driver Rise or Fall Time	t_{DR}, t_{DF}	Figures 5 and 7, $R_{DIFF} = 54\Omega$, $C_{L1} = C_{L2} = 100pF$	5	15	30	ns
Maximum Data Rate	f_{MAX}				10	Mbps
Driver Enable to Output High	t_{DZH}	Figures 6 and 8, $C_L = 100pF$, S2 closed		40	70	ns
Driver Enable to Output Low	t_{DZL}	Figures 6 and 8, $C_L = 100pF$, S1 closed		40	70	ns
Driver Disable Time from Low	t_{DLZ}	Figures 6 and 8, $C_L = 15pF$, S1 closed		40	70	ns
Driver Disable Time from High	t_{DHZ}	Figures 6 and 8, $C_L = 15pF$, S2 closed		40	70	ns
Receiver Input to Output	t_{RPLH}, t_{RPHL}	Figures 9 and 11; $ V_{ID} \geq 2.0V$; rise and fall time of $V_{ID} \leq 15ns$	20	100	180	ns
$ t_{RPLH} - t_{RPHL} $ Differential Receiver Skew	t_{RSKD}	Figures 9 and 11; $ V_{ID} \geq 2.0V$; rise and fall time of $V_{ID} \leq 15ns$		13		ns
Receiver Enable to Output Low	t_{RZL}	Figures 4 and 10, $C_L = 100pF$, S1 closed		40	100	ns
Receiver Enable to Output High	t_{RZH}	Figures 4 and 10, $C_L = 100pF$, S2 closed		40	100	ns
Receiver Disable Time from Low	t_{RLZ}	Figures 4 and 10, $C_L = 100pF$, S1 closed		40	100	ns
Receiver Disable Time from High	t_{RHZ}	Figures 4 and 10, $C_L = 100pF$, S2 closed		40	100	ns
Time to Shutdown	t_{SHDN}	(Note 4)	50	200	600	ns
Driver Enable from Shutdown to Output High	$t_{DZH(SHDN)}$	Figures 6 and 8, $C_L = 15pF$, S2 closed		40	200	ns
Driver Enable from Shutdown to Output Low	$t_{DZL(SHDN)}$	Figures 6 and 8, $C_L = 15pF$, S1 closed		40	200	ns
Receiver Enable from Shutdown- to-Output High	$t_{RZH(SHDN)}$	Figures 4 and 10, $C_L = 100pF$, S2 closed		150	500	ns
Receiver Enable from Shutdown- to-Output Low	$t_{RZL(SHDN)}$	Figures 4 and 10, $C_L = 100pF$, S1 closed		150	500	ns

Note 4: The device is put into shutdown by bringing \overline{RE} high and DE low. If the enable inputs are in this state for less than 50ns, the device is guaranteed not to enter shutdown. If the enable inputs are in this state for at least 600ns, the device is guaranteed to have entered shutdown.

Typical Operating Characteristics

($V_{CC} = +3.3V$, $T_A = +25^{\circ}C$, unless otherwise noted.)

No Load Supply Current vs. Temperature

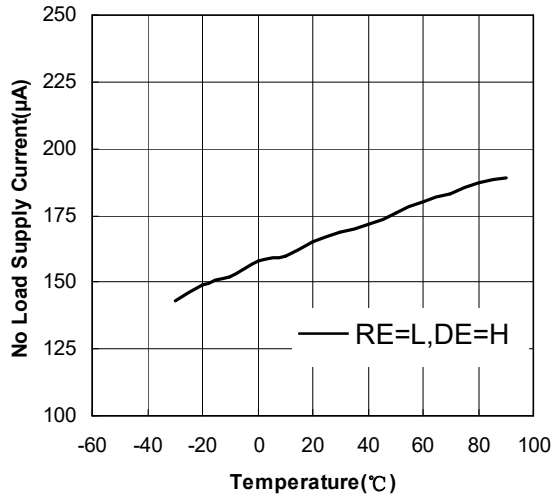

Output Current vs. Receiver Output High Voltage

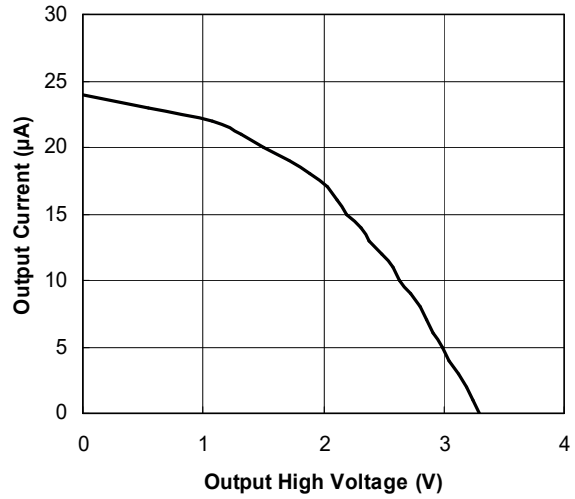

Output Current vs. Receiver Output Low Voltage

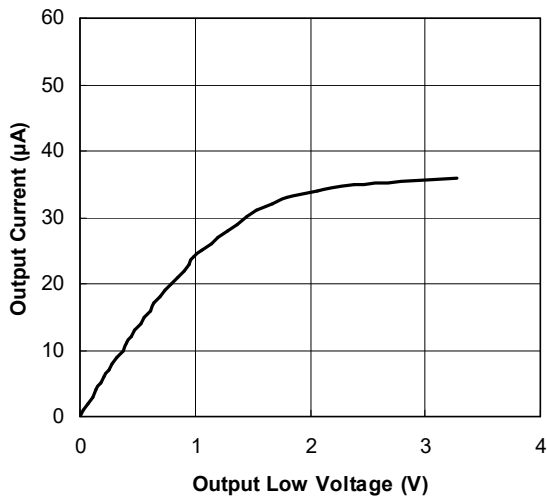

Receiver Output High Voltage vs. Temperature

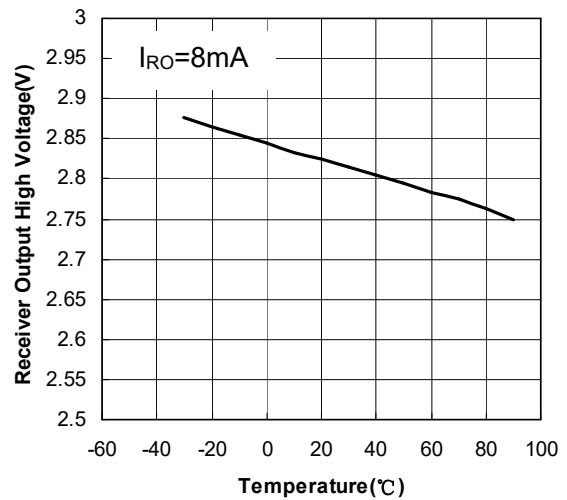

Typical Operating Characteristics (Continued)

($V_{CC} = +3.3V$, $T_A = +25^\circ C$, unless otherwise noted.)

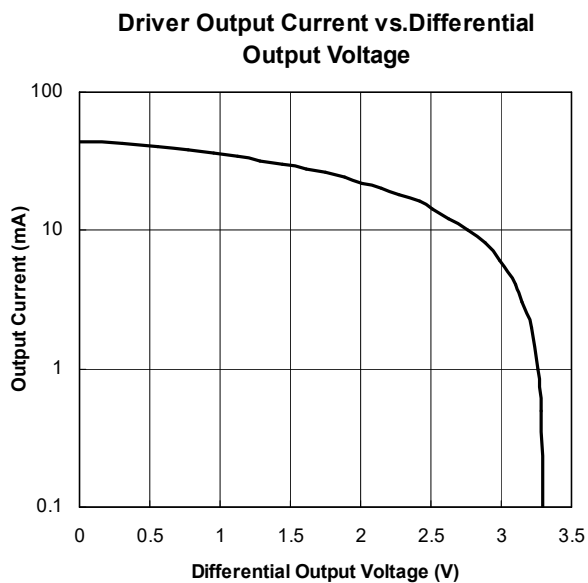
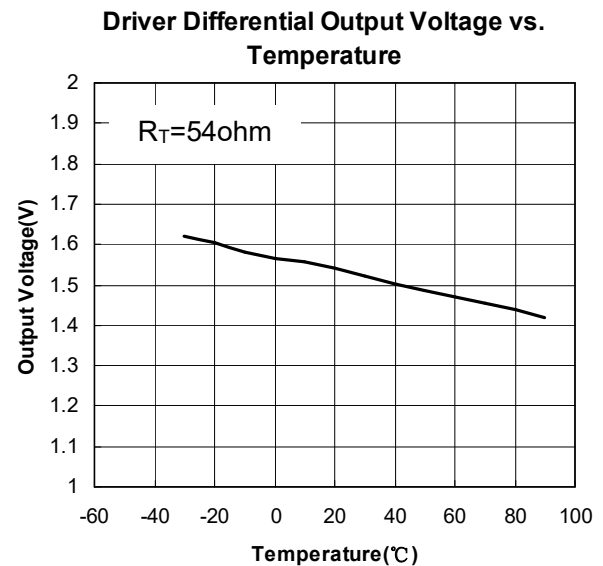
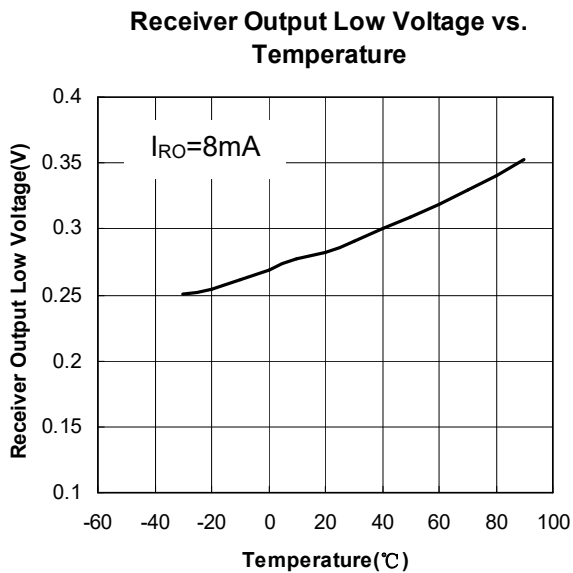

Pin Description

Pin Number		Symbol	Function
UM3488	UM3491		
-	1	NC	Not Connected
2	2	RO	Receiver Output. When \overline{RE} is low and if $A - B \geq -50\text{mV}$, RO will be high; if $A - B \leq -200\text{mV}$, RO will be low.
-	3	\overline{RE}	Receiver Output Enable. Drive \overline{RE} low to enable RO; RO is high impedance when \overline{RE} is high. Drive \overline{RE} high and DE low to enter low-power shutdown mode.
-	4	DE	Driver Output Enable. Drive DE high to enable driver outputs. These outputs are high impedance when DE is low. Drive \overline{RE} high and DE low to enter low-power shutdown mode.
3	5	DI	Driver Input. With DE high, a low on DI forces non-inverting output low and inverting output high. Similarly, a high on DI forces non-inverting output high and inverting output low.
4	6	GND	Ground
4	7	GND	Ground
-	8	NC	Not Connected
5	9	Y	Non-inverting Driver Output
6	10	Z	Inverting Driver Output
7	11	B	Inverting Receiver Input
8	12	A	Non-inverting Receiver Input
-	13	NC	Not Connected
1	14	VCC	Positive Supply $3.135\text{V} \leq VCC \leq 3.465\text{V}$

Functions Tables

TRANSMITTING				
INPUTS			OUTPUTS	
\overline{RE}	DE	DI	Z	Y
X	1	1	0	1
X	1	0	1	0
0	0	X	High-Z	High-Z
1	0	X	Shutdown	

RECEIVING			
INPUTS			OUTPUT
\overline{RE}	DE	A-B	RO
0	X	$\geq -0.05\text{V}$	1
0	X	$\leq -0.2\text{V}$	0
0	X	Open/Short	1
1	1	X	High-Z
1	0	X	Shutdown

Typical Operating Circuit

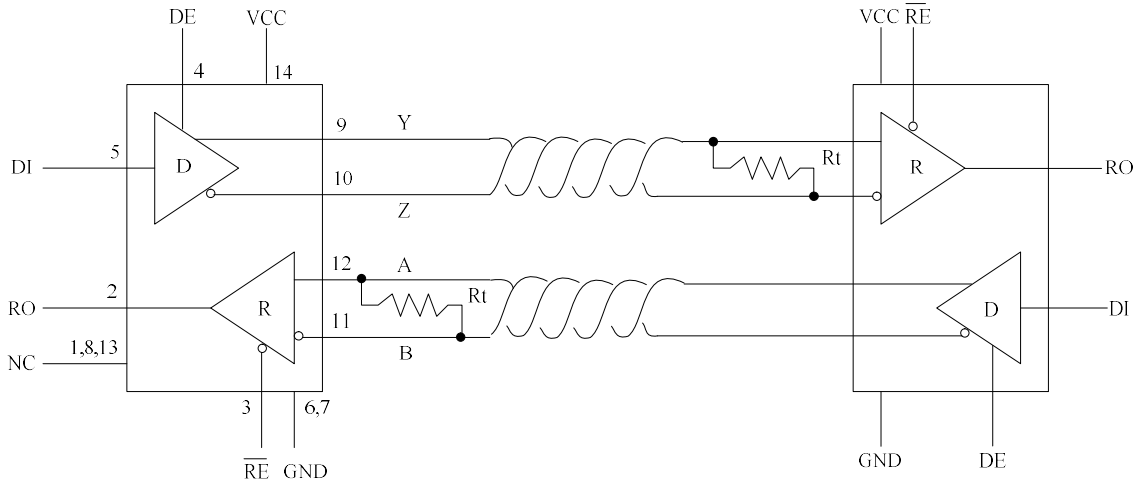

Figure 1: UM3491 pin configuration and typical full-duplex operating circuit

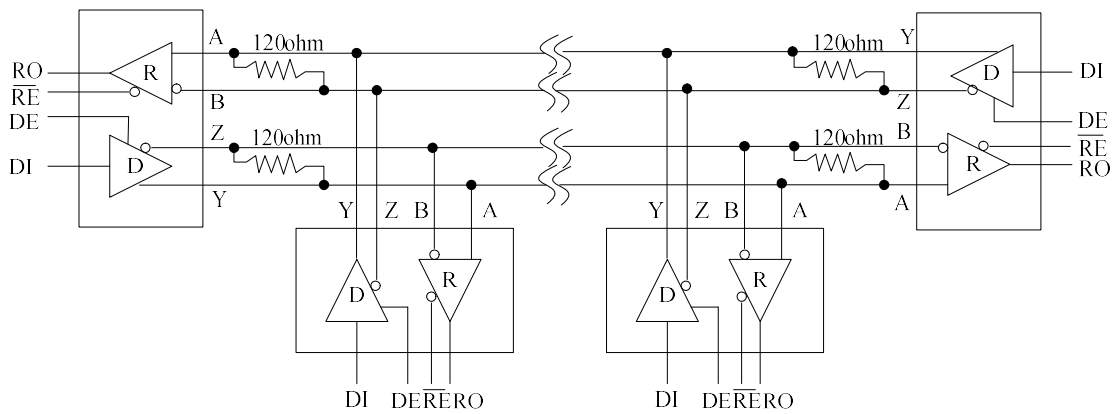

Figure 2: Typical Full-Duplex RS-422 Network

Detailed Description

The UM3488/UM3491 high-speed transceivers for RS-422 communication contain one driver and one receiver. The device features fail-safe circuitry, which guarantees a logic-high receiver output when the receiver inputs are open or shorted, or when they are connected to a terminated transmission line with all drivers disabled.

The UM3488/UM3491 offer higher driver output slew-rate limits, allowing transmit speeds up to 10Mbps.

The UM3488/UM3491 is full-duplex transceiver. It operates from a single +3.3V supply. Drivers are output short-circuit current limited. Thermal shutdown circuitry protects drivers against excessive power dissipation. When activated, the thermal shutdown circuitry places the driver outputs into a high-impedance state.

Receiver Input Filtering

The receivers of the UM3488/UM3491 incorporate input filtering in addition to input hysteresis. This filtering enhances noise immunity with differential signals that have very slow rise and fall times. Receiver propagation delay increases by 20% due to this filtering.

Fail-Safe

The UM3488/UM3491 guarantees a logic-high receiver output when the receiver inputs are shorted or open, or when they are connected to a terminated transmission line with all drivers disabled. This is done by setting the receiver threshold between -50mV and -200mV. If the differential receiver input voltage (A-B) is greater than or equal to -50mV, RO is logic high. If A-B is less than or equal to -200mV, RO is logic low. In the case of a terminated bus with all transmitters disabled, the receiver's differential input voltage is pulled to 0V by the termination. With the receiver thresholds of the UM3488/UM3491, this results in a logic high with a 50mV minimum noise margin. Unlike previous fail-safe devices, the -50mV to -200mV threshold complies with the $\pm 200\text{mV}$ EIA/TIA-422 standard.

$\pm 15\text{kV}$ ESD Protection

As with all Union devices, ESD-protection structures are incorporated on all pins to protect against electrostatic discharges encountered during handling and assembly. The driver outputs and receiver inputs of the UM3488/UM3491 have extra protection against static electricity. Union's engineers have developed state-of-the-art structures to protect these pins against ESD of $\pm 15\text{kV}$ without damage.

The ESD-protected pins are tested with reference to the ground pin in a powered-down condition. They are tested to $\pm 15\text{kV}$ using the Human Body Model.

Test Circuit

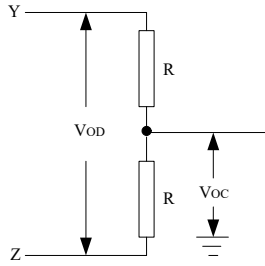

Figure 3. Driver DC Test Load

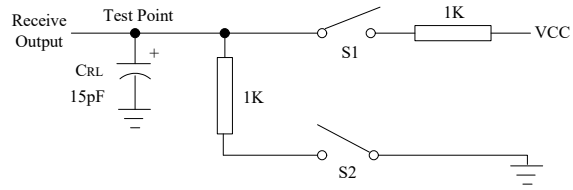

Figure 4. Receiver Enable/Disable Timing Test Load

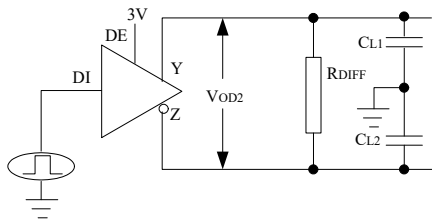

Figure 5. Driver Timing Test Circuit

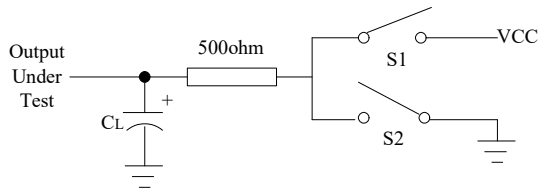

Figure 6. Driver Enable and Disable Timing Test Load

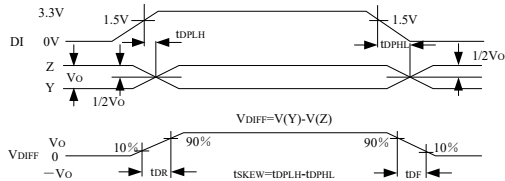

Figure 7. Driver Propagation Delays

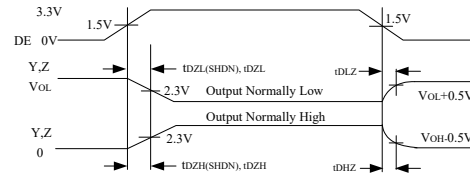

Figure 8. Driver Enable and Disable Times

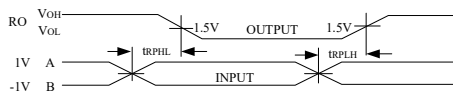

Figure 9. Receiver Propagation Delays

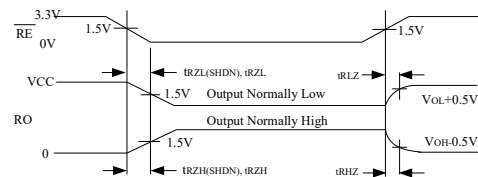

Figure 10. Receiver Enable and Disable Times

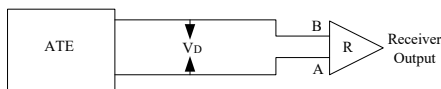

Figure 11. Receiver Propagation Delay Test Circuit

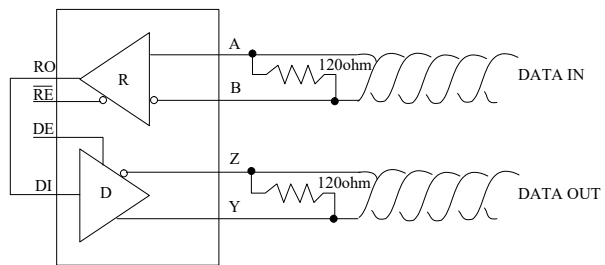

Figure 12: Line Repeater

Applications Information

256 Transceivers on the Bus

The standard RS-422 receiver input impedance is 12k Ω (one-unit load), and the standard driver can drive up to 32 unit loads. The UM3491 has a 1/8-unit-load receiver input impedance (96k Ω), allowing up to 256 transceivers to be connected in parallel on one communication line. Any combination of these devices and/or other RS-422 transceivers with a total of 32 unit loads or less can be connected to the line.

Reduced EMI and Reflections

The UM3488/UM3491 is slew-rate limited, minimizing EMI and reducing reflections caused by improperly terminated cables. Its high-frequency harmonic components are much lower in amplitude, and the potential for EMI is significantly reduced.

In general, a transmitter's rise time relates directly to the length of an unterminated stub, which can be driven with only minor waveform reflections. The following equation expresses this relationship conservatively:

$$\text{Length} = t_{\text{RISE}} / (10 \times 1.5\text{ns/ft})$$

where t_{RISE} is the transmitter's rise time.

Low-Power Shutdown Mode (UM3491)

Low-power shutdown mode is initiated by bringing both $\overline{\text{RE}}$ high and DE low. In shutdown, the devices typically draw only 1nA of supply current. $\overline{\text{RE}}$ and DE may be driven simultaneously; the parts are guaranteed not to enter shutdown if $\overline{\text{RE}}$ is high and DE is low for less than 50ns. If the inputs are in this state for at least 600ns, the parts are guaranteed to enter shutdown.

Enable times t_{ZH} and t_{ZL} in the Switching Characteristics tables assume the part was not in a low-power shutdown state. Enable times $t_{\text{ZH(SHDN)}}$ and $t_{\text{ZL(SHDN)}}$ assume the parts were shut down. It takes drivers and receivers longer to become enabled from low-power shutdown mode ($t_{\text{ZH(SHDN)}}$, $t_{\text{ZL(SHDN)}}$) than from driver/receiver-disable mode (t_{ZH} , t_{ZL}).

Driver Output Protection

Two mechanisms prevent excessive output current and power dissipation caused by faults or by bus contention. The first, a foldback current limit on the output stage, provides immediate protection against short circuits over the whole common-mode voltage range. The second, a thermal shutdown circuit, forces the driver outputs into a high-impedance state if the die temperature becomes excessive.

Line Length vs. Data Rate

The RS-422 standard covers line lengths up to 4000 feet. For line lengths greater than 4000 feet, use the repeater application shown in Figure 12.

Package Information

UM3488EESA SOP8

Outline Drawing

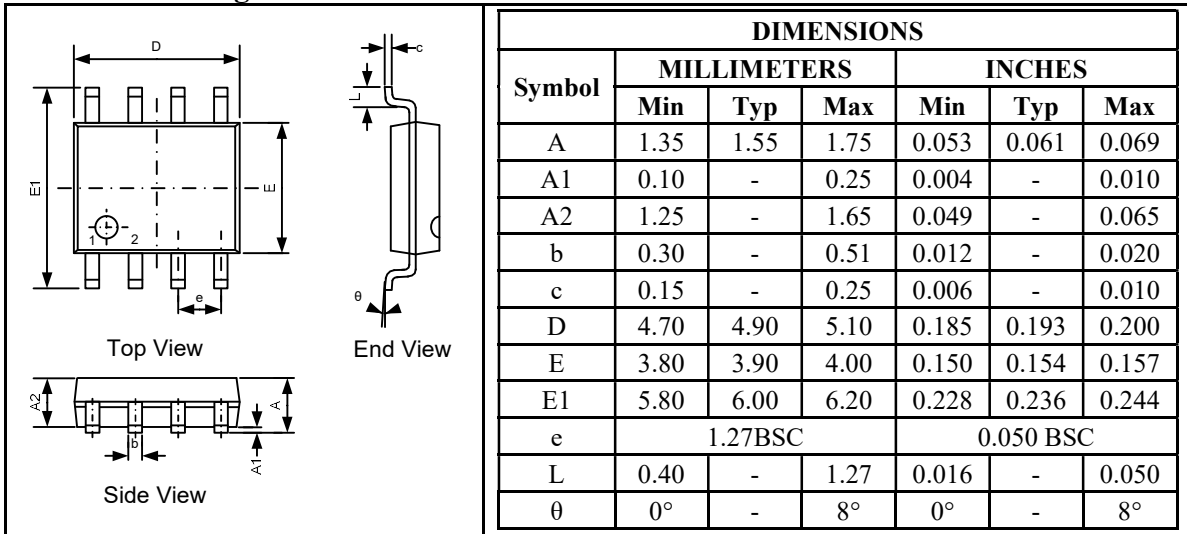

Land Pattern

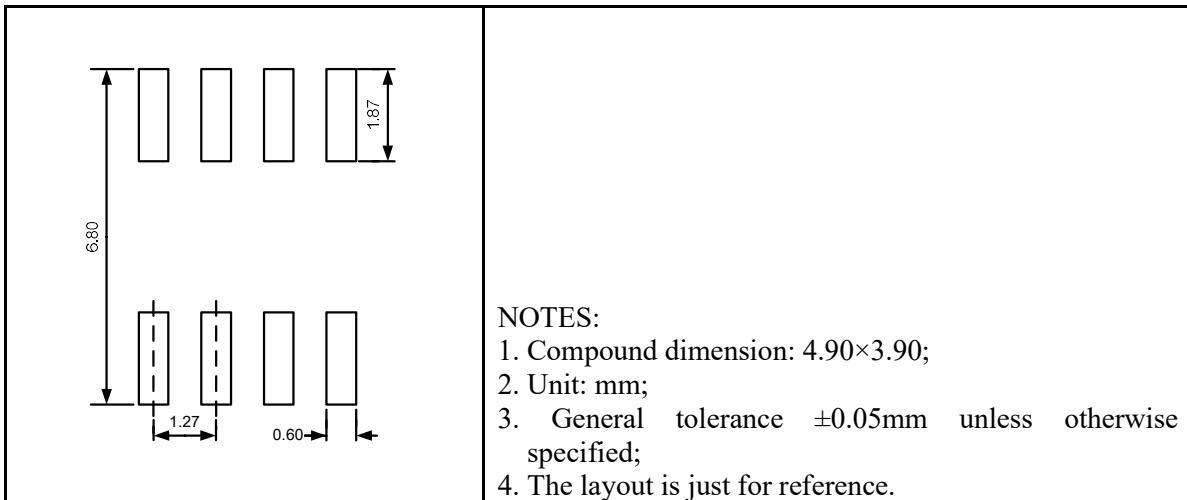

Tape and Reel Orientation

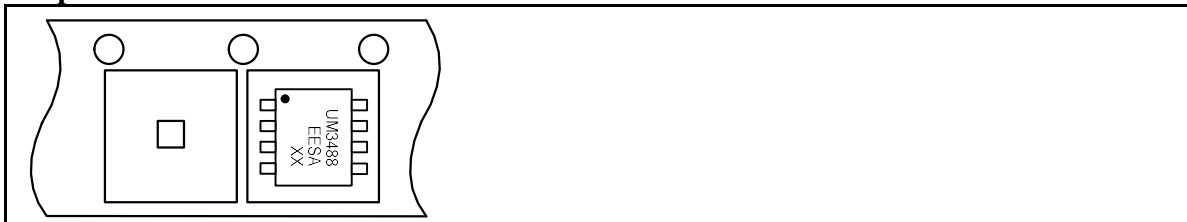

UM3488EEPA DIP8

Outline Drawing

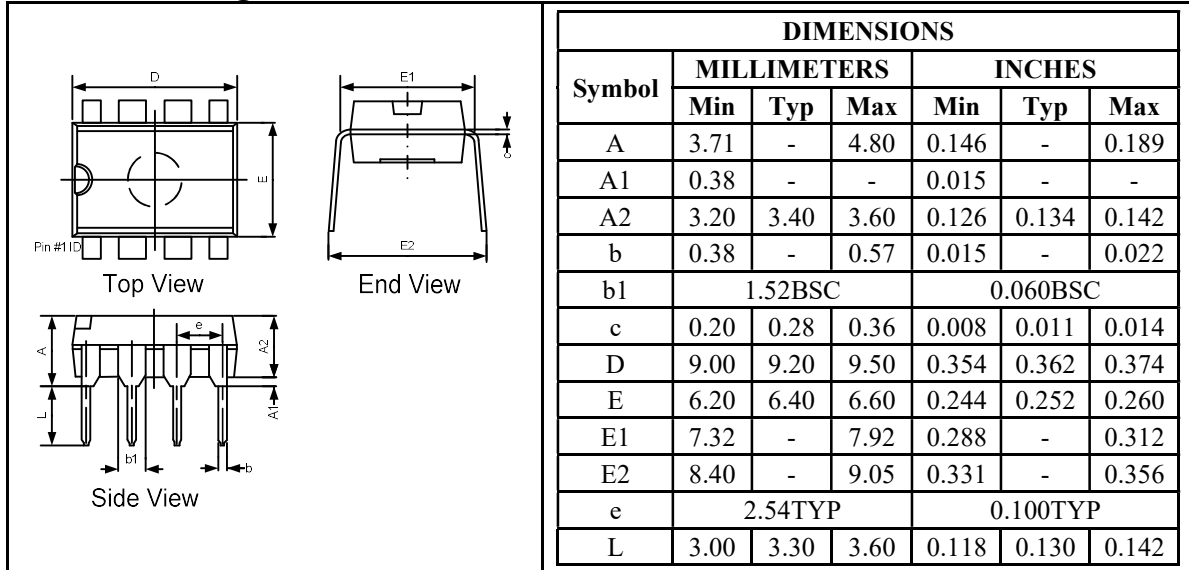

UM3491EESOP14

Outline Drawing

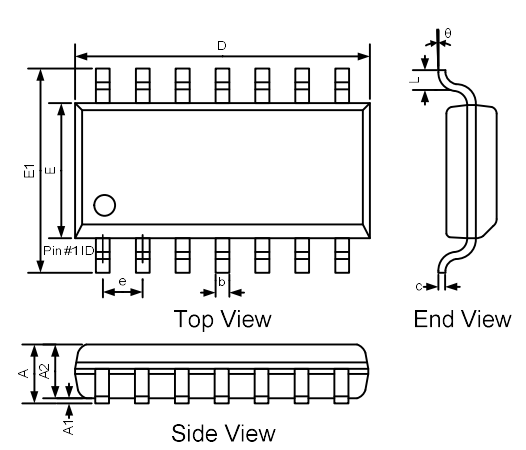

DIMENSIONS						
Symbol	MILLIMETERS			INCHES		
	Min	Typ	Max	Min	Typ	Max
A	1.35	1.60	1.75	0.053	0.063	0.069
A1	0.10	0.15	0.25	0.004	0.006	0.010
A2	1.25	1.45	1.65	0.049	0.057	0.065
b	0.36	-	0.49	0.014	-	0.019
c	0.17	-	0.25	0.007	-	0.010
D	8.53	8.63	8.73	0.336	0.340	0.344
E	3.80	3.90	4.00	0.150	0.154	0.157
E1	5.80	6.00	6.20	0.228	0.236	0.244
e	1.27BSC			0.050BSC		
L	0.45	0.60	0.80	0.018	0.024	0.031
θ	0°	-	8°	0°	-	8°

Land Pattern

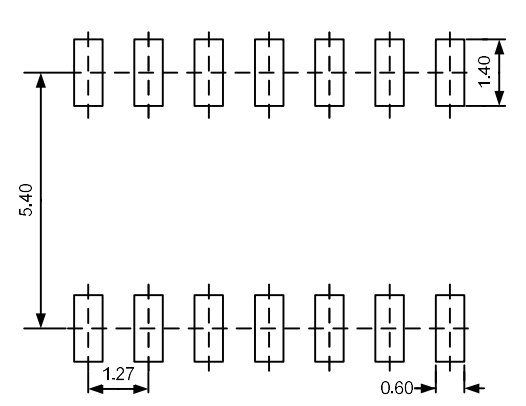

NOTES:

1. Compound dimension: 8.63×3.90 ;
2. Unit: mm;
3. General tolerance ±0.05mm unless otherwise specified;
4. The layout is just for reference.

Tape and Reel Orientation



UM3491EEPE DIP14

Outline Drawing

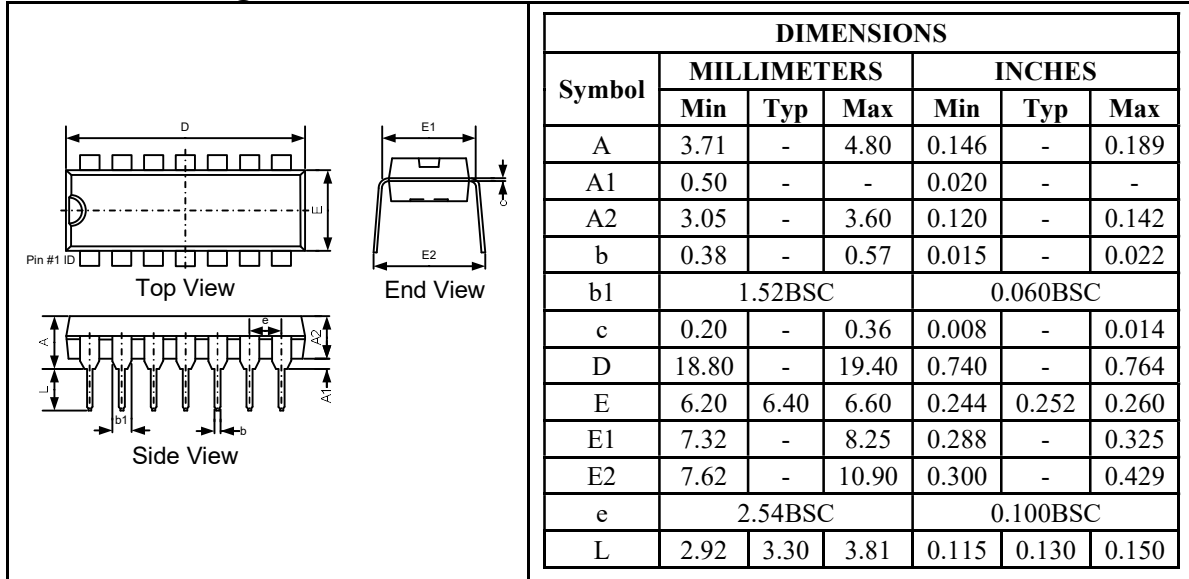

GREEN COMPLIANCE

Union Semiconductor is committed to environmental excellence in all aspects of its operations including meeting or exceeding regulatory requirements with respect to the use of hazardous substances. Numerous successful programs have been implemented to reduce the use of hazardous substances and/or emissions.

All Union components are compliant with the RoHS directive, which helps to support customers in their compliance with environmental directives. For more green compliance information, please visit:

http://www.union-ic.com/index.aspx?cat_code=RoHSDeclaration

IMPORTANT NOTICE

The information in this document has been carefully reviewed and is believed to be accurate. Nonetheless, this document is subject to change without notice. Union assumes no responsibility for any inaccuracies that may be contained in this document, and makes no commitment to update or to keep current the contained information, or to notify a person or organization of any update. Union reserves the right to make changes, at any time, in order to improve reliability, function or design and to attempt to supply the best product possible.



Union Semiconductor, Inc

Add: Unit 606, No.570 Shengxia Road, Shanghai 201210

Tel: 021-51093966

Fax: 021-51026018

Website: www.union-ic.com

X-ON Electronics

Largest Supplier of Electrical and Electronic Components

Click to view similar products for [RS-422/RS-485 Interface IC category](#):

Click to view products by [Union manufacturer](#):

Other Similar products are found below :

[SP3494CN-L/TR](#) [ISL4486IBZ-T](#) [ISL4491EIB](#) [ISL4491EIBZ-T](#) [ISL81483IB](#) [ISL83086EIB](#) [ISL83088EIB](#) [ISL83488IB](#) [ISL8483EIB](#)
[ISL8487EIB](#) [ISL8489EIB](#) [ISL8491IP](#) [ADM489AN](#) [CA-IS3080WX](#) [CA-IS3086WX](#) [SIT65HVD75ETK](#) [GM13487E](#) [CS48520M](#) [CA-](#)
[IF4820FD](#) [HSN65HVD12DR](#) [UM3088EESA](#) [ISOW1412BDFMR](#) [MAX485MJA/883B](#) [CA-IF4888HS](#) [CS485M](#) [CLM3085ESA+](#)
[CLM485ESA+](#) [CLM485EESA+](#) [CLM3085EESA+](#) [CS4585EO](#) [DW3085](#) [WS3471EEUA](#) [WS3079](#) [MS2583](#) [H485EIMM/TR](#) [SP3485EN-](#)
[HXY](#) [SP3483EN-HXY](#) [ST3485EBDR-HXY](#) [MAX1487ESA-HXY](#) [MAX3483ESA-HXY](#) [MAX487ESA-HXY](#) [SN75LBC184DR-HXY](#)
[MAX485EESA-HXY](#) [SN65LBC184N-HXY](#) [SN75176N-HXY](#) [MAX3485EESA-HXY](#) [SP3485EN-MS](#) [SIT3490EEPA](#) [SP3485EET](#)
[UM3488EESA](#)