

UniOhm

Uniroyal Electronics Industry Co., Ltd.

厚声电子工业有限公司

2013 - 2014



UniOhm

Uniroyal Electronics Industry Co., Ltd.

厚声电子工业有限公司

21 Xiajia North Road, Economic & Technical Development Zone,
Kunshan City, Jiangsu, CHINA 215334

中国江苏省昆山市经济技术开发区夏驾北路 21 号
邮编 : 215334

Tel: +86 512 5763 1400 / 1411 / 1422 / 1433

fax: +86 512 5763 4599

localsales@uniohm.com

globalsales@uniohm.com

www.uniohm.com

Surface Mount Category - CHIP, CHIP ARRAY & CHIP NETWORK Resistors (表面贴装式 – 晶片电阻, 晶片排列电阻及晶片网络电阻器)

| | | | |
|------------|--|----|---|
| | Thick Film Chip Resistors 厚膜晶片电阻器 | 3 | O1005, O201, O402, O603, O805, 1206, 1210, 1812, 2010, 2512 |
| | High Resistance Thick Film Chip Resistors 高阻厚膜晶片电阻器 | 6 | O603, O805, 1206, 1210 |
| | Anti-Surge Thick Film Chip Resistors 抗浪涌厚膜晶片电阻器 | 7 | AS03, AS05, AS06, AS07 |
| New | High-Precision Anti-Surge Thick Film Chip Resistors - PS 高精度抗浪涌厚膜晶片电阻器 - PS | 9 | PS05, PS06, PS07 |
| | High-Power Thick Film Chip Resistors 高功率厚膜晶片电阻器 | 11 | HP02, HP03, HP05, HP06, HP07, HP10, HP12 |
| | Low Resistance High-Power Thick F.C.R. 高功率低阻值厚膜晶片电阻器 | 13 | HP03, HP05, HP06, HP07, HP10, HP12 |
| | High-Voltage Thick Film Chip Resistors 高压厚膜晶片电阻器 | 14 | HV03, HV05, HV06, HV07, HV10, HV12 |
| | Wide-Terminal Thick Film Chip Resistors 宽电极厚膜晶片电阻器 | 16 | O508, O612, 1020, 1218, 1225 |
| | Trimable Thick Film Chip Resistors 可调厚膜晶片电阻器 | 18 | TR03, TR05, TR06 |
| | Current Sensing Chip Resistors 晶片电流检测电阻器 | 20 | CS03, CS05, CS06, CS07, CS10, CS12 |
| New | AEC-Q200 Version Chip Resistors - HQ 汽车用晶片电阻 -HQ | 22 | HQ02, HQ03, HQ05, HQ06, HQ07, HQ10, HQ12 |
| New | Non-magnetic Thick Film Chip Resistors - NM 无磁厚膜晶片电阻器 - NM | 24 | NM02, NM03, NM05 |
| New | Anti-Sulfurized Thick Film Chip Resistors - NS 抗硫化厚膜晶片电阻器 - NS | 26 | NS03, NS05, NS06 |
| New | Flex LED Strip use Thick Film Chip Resistors - LE 软灯条专用电阻器 - LE | 28 | LE06 |
| | High-Precision Thin Film Chip Resistors 高精度薄膜晶片电阻器 | 30 | TC02, TC03, TC05, TC06, TC07, TC10, TC12 |
| | High Power Thin Film Chip Resistors 高功率薄膜晶片电阻器 | 32 | TP03, TP05, TP06 |
| | Thin Film Chip Resistors 薄膜晶片电阻器 | 33 | TC02, TC03, TC05, TC06 |
| | Chip Resistors Array - Convex Terminal 晶片排列电阻器 – 凸式电极 | 34 | 2D02, 4D02, 4D03, 16P8 |
| | Chip Resistors Array - Concave Terminal 晶片排列电阻器 – 凹式电极 | 35 | 2C02, 4C02, 4C03 |
| | Thick Film Chip Resistors Network 厚膜晶片网络电阻器 | 36 | 10P8, 10S8, 10T8, 10E9 |
| | Packing of Surface Mount Resistors 表面贴装式电阻器包装 | 37 | Packing of Surface Mount Resistors |

Through Hole Category - Network Resistors & Traditional Coated Resistors (插件式 – 排列电阻 & 涂装型电阻)

| | | | |
|------------|--|----|---|
| | Resistor Network - SIP Series 网络电阻器 - SIP 系列 | 38 | RNL-A, RNL-B, RNL-C, RNL-D, RNL-E, RNL-L, RNL-R, RNL-G, RNL-P |
| | High Power Resistor Network - SIP RPL Series 高功率网络电阻器 - SIP RPL 系列 | 40 | RPL-A, RPL-B, RPL-R |
| | High Power Resistors Network Medium Profile—SIP RNM Series 高功率中宽度网络电阻器 - SIP RNM 系列 | 42 | RNM-A, RNM-B, RNM-R |
| | High Power Resistors Network High Profile—SIP RPH Series 高功率高宽度网络电阻器 - SIP RPH 系列 | 44 | RPH-A, RPH-B, RPH-R |
| | Special Network –SIP Series 特殊网络电阻器 - SIP 系列 | 46 | SN0001, SN0002, SN0003, SN0004 |
| | Resistor/Capacitor Network-SIP Series 网络阻容器电阻器 - SIP 系列 | 47 | RCN-A, RCN-B |
| | Capacitor Network-SIP Series 网络电容器 - SIP 系列 | 48 | CNM-1 |
| | High Voltage Flat Resistors 高压扁平式电阻器 | 49 | HFR |
| | Carbon Film Fixed Resistors 碳膜电阻器 | 50 | CFR |
| | Precision Metal Film Fixed Resistors 精密金属膜电阻器 | 52 | MFR |
| | Carbon Film Power Resistors 高功率碳膜电阻器 | 54 | CPR |
| | Metal Film Power Resistors 高功率金属膜电阻器 | 55 | MPR |
| | Metal Oxide Film Fixed Resistors 金属氧化膜固定电阻器 | 56 | MOR |
| | Wire-wound Fixed Resistors 绕线型固定电阻器 | 58 | KNP, KNH, KNS |
| New | Wire-Wound Anti Surge Fixed Resistors 绕线耐脉冲电阻器 | 60 | KSR |
| | Wire-wound Power Resistors 高功率绕线型固定电阻器 | 61 | WPR |
| | Fusible Resistors 保险丝电阻器 | 62 | FRN |
| | Wire-wound Fusible Resistors 绕线保险丝型电阻器 | 64 | KFR |
| | Thermal Fusing Wire-wound Fixed Resistors 绕线型温度保险丝电阻器 | 66 | TFR |
| | Current Sense Resistors 电流检测线电阻器 | 67 | CSR |
| New | Current Sense Spring Resistors 弹簧式电流检测电阻器 | 68 | CSSA, CSSB, CSSC |
| | Metal Glaze Film Fixed Resistors 金属玻璃釉膜固定电阻器 | 69 | MGR |

| | | |
|---|----|-------------------------------|
| High-Value Metal Glaze Film Fixed Resistors 超高阻玻璃釉膜固定电阻器 | 71 | HMGR |
| High-Voltage Metal Glaze Film Fixed Resistors 耐高压型玻璃釉膜固定电阻器 | 72 | HVR |
| Terminal Type Metal Oxide Film Resistors 端片型金属氧化膜电阻器 | 73 | TMOR, TMOV, TMOL |
| Jumper Wires & Zero-Ohm Resistors 跳线及零欧姆电阻器 | 74 | ZW, ZO, ZF |
| Copper Plated Steel Lead Wire Type & Cutting Type 铜包钢导线型及切割半成品型 | 75 | CP, CO |
| Panasert Type (Panasert 型) | 76 | |
| Avisert Type (Avisert 型) | 77 | AVI-1, AVI-2, AVI-3 |
| M & F Forming Type (M 型 & F 型 < 成型 >) | 79 | MF, MK, ML, F, F1, F2, F3 |
| Standard Packing of Coated Type Resistors 涂装型电阻器包装标准 | 81 | Tape/Box, Tape/Reel, Bulk/Box |

Through Hole Category - Traditional Cement Resistors (插件式 - 水泥型电阻)

| | | |
|---|-----|----------------------------------|
| Axial Leaded Terminal Type-PRW Series 轴式导线型 - PRW 系列 | 87 | PRW, PRWA, PRWC |
| Radial Leaded Type-PRM & PRS Series 立式导线型 - PRM & PRS 系列 | 88 | PRM, PRMA, PRMB, PRMT, PRS |
| Radial Terminal Type - PRV Series 立式端片型 - PRV 系列 | 89 | PRVA, PRVB |
| Radial Terminal Type - PRZ Series 立式端片型 - PRZ 系列 | 90 | PRZA, PRZA-1, PRZC, PRZC-1, PRZD |
| Radial Terminal Type - PRT & PRU Series 立式端片型 - PRT & PRU 系列 | 91 | PRT, PRU, PRU-1 |
| New Radial Terminal Type - PRTM Series 立式端片型 - PRTM 系列 | 93 | PRTM |
| Leaded Type Cement Thermal Fusing Resistors 导线型水泥保险丝电阻器 | 94 | FTR, PHF, PHF1, PHF2 |
| Ultra-Low Value Cement Resistors 超低阻水泥固定电阻器 | 96 | PRWU |
| Power Flat Alloy Resistors 功率型合金箔电阻器 | 97 | PFAS, PFAT |
| Columnar Type Cement Fixed Resistors 圆柱状水泥电阻器 | 99 | QHO |
| Standard Packing of Cement Type Resistors 水泥型电阻器包装标准 | 100 | Bulk/Box |

Power Type Resistors (功率型)

| | | |
|--|-----|------------------|
| Power Dissipation Mount Resistors 铝外壳电阻器 | 103 | PDM |
| High-Power Wire-wound Resistors 高功率绕线型固定电阻器 | 104 | BTR |
| High-Power Flat Wire-wound Fixed Resistors 高功率扁平型绕线固定电阻器 | 105 | KNHB |
| Multi-Leaded Wire-wound Resistors 多引线型绕线固定电阻器 | 106 | KNHW |
| High-Power Wire-wound Resistors 高功率绕线型固定电阻器 | 107 | HAWR |
| New High Power Wire Wound Flat aluminum shell Fixed Resistors 高功率绕线扁平铝壳电阻器 | 108 | HPWR |
| New High Power Wire Wound Trapezoid aluminum shell Fixed Resistors 高功率绕线梯形铝壳电阻器 | 109 | HPAR |
| New High Power Wire Wound Iron shell Fixed Resistors 高功率绕线铁壳固定电阻器 | 110 | HPWR |
| High-Temperature Wire-wound Resistors 高温绕线固定电阻器 | 111 | HAWF |
| Bilaeteral Cement Resistors 双体水泥固定电阻 | 112 | BCR |
| Vitreous Enameled Wire-wound Resistors 珐琅釉绕线固定电阻器 | 113 | URX |
| Power Type Thermal Fusing Resistors 功率型温度保险丝电阻 | 114 | TFO, TFRC |
| Power (Ribbon) Wire-wound Resistors 功率 (合金带) 绕线型电阻器 | 115 | QH, QL, QR, QRZG |

RELATIVE INFORMATION (相关资料)

| | | |
|--|-----|--|
| Test Method of JIS-C-5201 & JIS-C-5202 JIS-C-5201 和 JIS-C-5202 检测方法 | 117 | |
| Standard Nominal Resistance Value 标准电阻值 | 118 | |
| Explnation of Part No. System 料号系统注释 | 121 | |
| Standard Color Code System 标准色码系统 | 123 | |

Feature (特性)

- Small size & light weight 短小轻薄
- Reduction of assembly costs and matching with placement machine. 可降低装置成本及配合机器组装
- Suitable for both wave & re-flow soldering. 适合波峰焊与回流焊
- Applications: Navigator (GPS), Mobile Phone, Telecom, PDA, Setbox, Meter.
应用于GPS, 移动电话, PDA, 机顶盒, 仪表



Figures (型状)

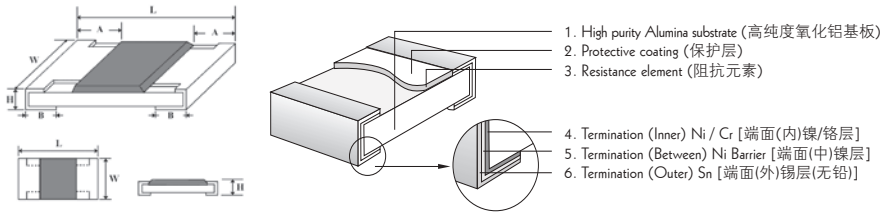

Derating Curve & Specification

降功率曲线及性能



| Type 类型 | 01005 <small>New</small> | 0201 | 0402 | 0603 | 0805 | 1206 | 1210 | 1812 | 2010 | 2512 |
|---|--------------------------|------------|------------|------------|------------|------------|------------|------------|------------|------------|
| Max. Working Voltage 最大工作电压 | 15V | 25V | 50V | 50V | 150V | 200V | 200V | 200V | 200V | 200V |
| Max. Overload Voltage 最大过负荷电压 | 30V | 50V | 100V | 100V | 300V | 400V | 500V | 500V | 500V | 500V |
| Dielectric withstanding Voltage 绝缘耐压 | - | - | 100V | 300V | 500V | 500V | 500V | 500V | 500V | 500V |
| Operating Temperature 工作温度范围 | -55~+155°C | -55~+155°C | -55~+155°C | -55~+155°C | -55~+155°C | -55~+155°C | -55~+155°C | -55~+155°C | -55~+155°C | -55~+155°C |

| Type 类型 | 01005 <small>New</small> | 0201 | 0402 | 0603 | 0805 | 1206 | 1210 | 1812 | 2010 | 2512 |
|---|--------------------------|-------------|-------------|--|--|--|--|------------------|--|--|
| Power Rating at 70°C 功率 | 1/32W | 1/20W | 1/16W | 1/16W (1/10W-S) | 1/10W (1/8W-S) | 1/8W (1/4W-S) | 1/4W (1/3W-S 1/2W-SS) * | 1/2W (3/4W-S) | 1/2W (3/4W-S) | 1W |
| L (mm) | 0.40 ± 0.02 | 0.60 ± 0.03 | 1.00 ± 0.10 | 1.60 ± 0.10 | 2.00 ± 0.15 | 3.10 ± 0.15 | 3.10 ± 0.10 | 4.50 ± 0.20 | 5.00 ± 0.10 | 6.35 ± 0.10 |
| W (mm) | 0.20 ± 0.02 | 0.30 ± 0.03 | 0.50 ± 0.05 | 0.80 ^{+0.15} _{-0.10} | 1.25 ^{+0.15} _{-0.10} | 1.55 ^{+0.15} _{-0.10} | 2.60 ^{+0.15} _{-0.10} | 3.20 ± 0.20 | 2.50 ^{+0.15} _{-0.10} | 3.20 ^{+0.15} _{-0.10} |
| H (mm) | 0.13 ± 0.02 | 0.23 ± 0.03 | 0.35 ± 0.05 | 0.45 ± 0.10 | 0.55 ± 0.10 | 0.55 ± 0.10 | 0.55 ± 0.10 | 0.55 ± 0.20 | 0.55 ± 0.10 | 0.55 ± 0.10 |
| A (mm) | 0.10 ± 0.05 | 0.10 ± 0.05 | 0.20 ± 0.10 | 0.30 ± 0.20 | 0.40 ± 0.20 | 0.45 ± 0.20 | 0.50 ± 0.25 | 0.50 ± 0.20 | 0.60 ± 0.25 | 0.60 ± 0.25 |
| B (mm) | 0.10 ± 0.03 | 0.15 ± 0.05 | 0.25 ± 0.10 | 0.30 ± 0.20 | 0.40 ± 0.20 | 0.45 ± 0.20 | 0.50 ± 0.20 | 0.50 ± 0.20 | 0.50 ± 0.20 | 0.50 ± 0.20 |
| Resistance Value of Jumper 零欧姆电阻阻值 | - | <50mΩ | <50mΩ | <50mΩ | <50mΩ | <50mΩ | <50mΩ | <50mΩ | <50mΩ | <50mΩ |
| Rated Current of Jumper 零欧姆电阻额定电流 | - | 0.5A | 1A | 1A | 2A | 2A | 2A | 2A | 2A | 2A |
| Max. Current of Jumper 零欧姆电阻最大电流 | - | 1A | 2A | 2A | 5A | 10A | 10A | 10A | 10A | 10A |
| Resistance Range of 0.5% (E-96) 0.5% 的阻值范围(E-96) | - | - | 1Ω ~ 10MΩ | 1Ω ~ 10MΩ | 1Ω ~ 10MΩ | 1Ω ~ 10MΩ | 1Ω ~ 10MΩ | 1Ω ~ 10MΩ | 1Ω ~ 10MΩ | 1Ω ~ 10MΩ |
| Resistance Range of 1% (E-96) 1% 的阻值范围 (E-96) | 10Ω ~ 10MΩ | 1Ω ~ 10MΩ | 1Ω ~ 10MΩ | 1Ω ~ 10MΩ | 1Ω ~ 10MΩ | 1Ω ~ 10MΩ | 1Ω ~ 10MΩ | 1Ω ~ 10MΩ | 1Ω ~ 10MΩ | 1Ω ~ 10MΩ |
| Resistance Range of 2% (E-24) 2% 的阻值范围 (E-24) | 10Ω ~ 10MΩ | 1Ω ~ 10MΩ | 1Ω ~ 10MΩ | 1Ω ~ 10MΩ | 1Ω ~ 10MΩ | 1Ω ~ 10MΩ | 1Ω ~ 10MΩ | 1Ω ~ 10MΩ | 1Ω ~ 10MΩ | 1Ω ~ 10MΩ |
| Resistance Range of 5% (E-24) 5% 的阻值范围 (E-24) | 10Ω ~ 10MΩ | 1Ω ~ 10MΩ | 1Ω ~ 10MΩ | 1Ω ~ 10MΩ | 1Ω ~ 10MΩ | 1Ω ~ 10MΩ | 1Ω ~ 10MΩ | 1Ω ~ 10MΩ | 1Ω ~ 10MΩ | 1Ω ~ 10MΩ |

Marking on the Resistors Body (电阻本体字码标示)

- For 0201 & 0402 size, no marking on the body due to the small size of the resistor.
0201, 0402因电阻本体太小, 故本体无标示字码
- ±5% tolerance product: the marking is 3 digits, the first 2 digits are the significant of the resistance and the 3rd digit denotes number of zeros following.
±5%公差产品字码是三位数, 前二位是阻值的有效数, 第三位表示有几个0
- 0805, 1206, 1210, 2010, 2512 ≤±1%: the marking is 4 digits, the first 3 digits are the significant of the resistance and the 4th digit denotes number of zeros following.
0805, 1206, 1210, 2010, 2512 ≤±1%公差产品字码有四位数字, 前三位是阻值的有效数, 第四位表示有几个0
- Standard E-96 series values of 0603 ≤±1%: due to the small size of the resistor's body, 3 digits marking will be used to indicate the accurate resistance value by using the following Multiplier & Resistance Code.
0603 ≤±1%公差 E-96系列标准阻值, 因电阻本体太小, 采用三位阻值代码(数字)及下列指数代码(字母)配合来指明标准的阻值。

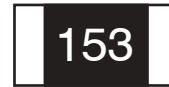

153 = 15000Ω = 15KΩ



Below 10Ω: 6R8 = 6.8Ω
10Ω 以下标示: 6R8 = 6.8Ω



2372 = 23700Ω = 23.7KΩ



Below 10Ω: 3R24 = 3.24Ω
10Ω 以下标示: 3R24 = 3.24Ω

Multiplier Code (for 0603 ≤±1% marking) [指数码 (0603≤±1% 标示)]

| Code 代码 | A | B | C | D | E | F | G | H | X | Y | Z |
|---------------|-----------------|-----------------|-----------------|-----------------|-----------------|-----------------|-----------------|-----------------|------------------|------------------|------------------|
| Multiplier 指数 | 10 ⁰ | 10 ¹ | 10 ² | 10 ³ | 10 ⁴ | 10 ⁵ | 10 ⁶ | 10 ⁷ | 10 ⁻¹ | 10 ⁻² | 10 ⁻³ |

Standard E-96 series Resistance Value code (for 0603 ≤±1% marking) [E-96系列标准阻值代码 (对0603≤±1%的字码)]

| Value 阻值 | Code 代码 | Value 阻值 | Code 代码 | Value 阻值 | Code 代码 | Value 阻值 | Code 代码 | Value 阻值 | Code 代码 | Value 阻值 | Code 代码 |
|----------|---------|----------|---------|----------|---------|----------|---------|----------|---------|----------|---------|
| 100 | 01 | 147 | 17 | 215 | 33 | 316 | 49 | 464 | 65 | 681 | 81 |
| 102 | 02 | 150 | 18 | 221 | 34 | 324 | 50 | 475 | 66 | 698 | 82 |
| 105 | 03 | 154 | 19 | 226 | 35 | 332 | 51 | 487 | 67 | 715 | 83 |
| 107 | 04 | 158 | 20 | 232 | 36 | 340 | 52 | 499 | 68 | 732 | 84 |
| 110 | 05 | 162 | 21 | 237 | 37 | 348 | 53 | 511 | 69 | 750 | 85 |
| 113 | 06 | 165 | 22 | 243 | 38 | 357 | 54 | 523 | 70 | 768 | 86 |
| 115 | 07 | 169 | 23 | 249 | 39 | 365 | 55 | 536 | 71 | 787 | 87 |
| 118 | 08 | 174 | 24 | 255 | 40 | 374 | 56 | 549 | 72 | 806 | 88 |
| 121 | 09 | 178 | 25 | 261 | 41 | 383 | 57 | 562 | 73 | 825 | 89 |
| 124 | 10 | 182 | 26 | 267 | 42 | 392 | 58 | 576 | 74 | 845 | 90 |
| 127 | 11 | 187 | 27 | 274 | 43 | 402 | 59 | 590 | 75 | 866 | 91 |
| 130 | 12 | 191 | 28 | 280 | 44 | 412 | 60 | 604 | 76 | 887 | 92 |
| 133 | 13 | 196 | 29 | 287 | 45 | 422 | 61 | 619 | 77 | 909 | 93 |
| 137 | 14 | 200 | 30 | 294 | 46 | 432 | 62 | 634 | 78 | 931 | 94 |
| 140 | 15 | 205 | 31 | 301 | 47 | 442 | 63 | 649 | 79 | 953 | 95 |
| 143 | 16 | 210 | 32 | 309 | 48 | 453 | 64 | 665 | 80 | 976 | 96 |

So the resistance value are marked as the following examples (阻值标示如下):



1.96KΩ = 196 × 10¹ Ω = 29B



12.4Ω = 124 × 10⁻¹ = 10X

- Standard E-24 and not belong to E-96 series values (≤±1%) of 0603 size: the marking is the same as 5% tolerance but marking as underline.
0603≤±1%公差, 在标准 E-24 系列中, 但不属 E-96 系列的阻值, 标示和5%的公差相同, 但是在字码下多加一条线



122 = 1200 = 1.2 KΩ



680 = 68Ω

Performance Specifications (性能)

| | | |
|---------------------------------|--------|--|
| Temperature coefficient | 温度系数 | 01005: $\pm 250\text{PPM}/^\circ\text{C}$ $1\Omega \sim 10\Omega \leq \pm 400\text{PPM}/^\circ\text{C}$ $11\Omega \sim 100\Omega \leq \pm 200\text{PPM}/^\circ\text{C}$ $> 100\Omega \pm 100\text{PPM}/^\circ\text{C}$ (0201 $> 100\Omega \pm 200\text{PPM}/^\circ\text{C}$) Provided Specially (特别提供): 0402: $\pm 0.5\%$ 100 $\Omega \sim 1\text{M}$: $\pm 50\text{PPM}/^\circ\text{C}$ 0603: $1\Omega \sim 10\Omega$: $\pm 200\text{PPM}/^\circ\text{C}$ 0805, 1206: $1\Omega \sim 10\Omega$: $\pm 100\text{PPM}/^\circ\text{C}$ |
| Short-time overload | 短时间过负荷 | $\pm 5\%$, $\pm 2\%$: $\pm(2.0\% + 0.1\Omega)$ Max(最大). $\pm 1\%$, $\pm 0.5\%$: $\pm(1.0\% + 0.1\Omega)$ Max(最大). |
| Insulation resistance | 绝缘电阻 | $\geq 1,000\text{ M}\Omega$ |
| Dielectric withstanding voltage | 绝缘耐压 | No evidence of flashover, mechanical damage, arcing or insulation breakdown 无击穿, 飞弧及可见机械性损伤 |
| Terminal bending | 端子弯曲 | $\pm(1.0\% + 0.05\Omega)$ Max(最大). |
| Soldering heat | 耐焊接热 | $\pm(1.0\% + 0.05\Omega)$ Max(最大). |
| Solderability | 可焊性 | Min. 95% coverage (最少 95% 覆盖率) |
| Temperature cycling | 温度循环 | $\pm 5\%$, $\pm 2\%$: $\pm(1.0\% + 0.05\Omega)$ Max(最大). $\pm 1\%$, $\pm 0.5\%$: $\pm(0.5\% + 0.05\Omega)$ Max(最大). |
| Humidity (Steady State) | 恒定湿热 | $\pm 5\%$, $\pm 2\%$: $\pm(3.0\% + 0.1\Omega)$ Max(最大). $\pm 1\%$, $\pm 0.5\%$: $\pm(0.5\% + 0.1\Omega)$ Max(最大). |
| Load life in humidity | 湿度寿命 | $\pm 5\%$, $\pm 2\%$: $\pm(3.0\% + 0.1\Omega)$ Max(最大). $\pm 1\%$, $\pm 0.5\%$: $\pm(1.0\% + 0.1\Omega)$ Max(最大). |
| Load life | 负载寿命 | $\pm 5\%$, $\pm 2\%$: $\pm(3.0\% + 0.1\Omega)$ Max(最大). $\pm 1\%$, $\pm 0.5\%$: $\pm(1.0\% + 0.1\Omega)$ Max(最大). |

• The values which are not of standard E-24 series (2% & 5%) and not of E-96 series (1%) could be offered on a case to case basis.
 阻值如不在 E-24 系列 (2% & 5%) 及 E-96 系列 (1%) 可特别提供

Ordering Procedure (Example: 1206 1/4W-S 5% 1.2 Ω T/R-5000)

订购方式 (例如: 1206 1/4W-S 5% 1.2 Ω T/R-5000)



Feature (特性)

- High Resistance 高阻值
- Suitable for reflow & wave soldering
适合波峰焊与回流焊
- Application AV adapters, LCD back-light camera strobe etc. 适用于AV适配器, LCD背光电路, 照相机快门等.

Figures (型状)

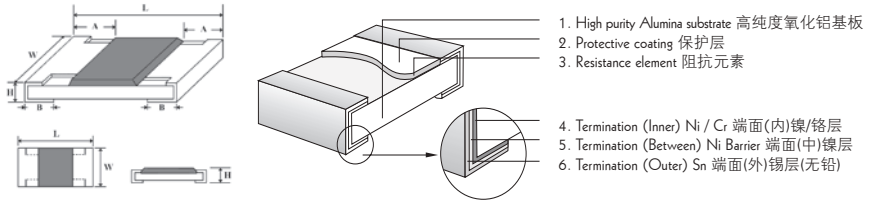

Derating Curve & Specification (降功率曲线及性能)

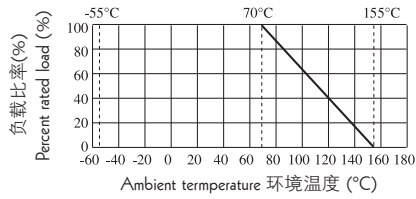

| Type 类型 | Max Working Voltage 最大工作电压 | Max Overload Voltage 最大过负荷电压 | Dielectric Withstanding Voltage 绝缘耐压 | Operating Temperature Range 工作温度范围 |
|---------|----------------------------|------------------------------|--------------------------------------|------------------------------------|
| 0603 | 50V | 100V | 300V | -55~+155°C |
| 0805 | 150V | 300V | 500V | |
| 1206 | 200V | 400V | 500V | |
| 1210 | 200V | 400V | 500V | |

| Type 类型 | Power (功率) (70°C) | L (mm) | W (mm) | H (mm) | A (mm) | B (mm) | Resistance Range (阻值范围) 5% (E24) |
|---------|-------------------|-----------|--|-----------|-----------|-----------|----------------------------------|
| 0603 | 1/16W 1/10W-S | 1.60±0.10 | 0.80 ^{+0.15} _{-0.10} | 0.45±0.10 | 0.30±0.20 | 0.30±0.20 | 10M~100M |
| 0805 | 1/10W 1/8W-S | 2.00±0.15 | 1.25 ^{+0.15} _{-0.10} | 0.55±0.10 | 0.40±0.20 | 0.40±0.20 | |
| 1206 | 1/8W 1/4W-S | 3.10±0.15 | 1.55 ^{+0.15} _{-0.10} | 0.55±0.10 | 0.45±0.20 | 0.45±0.20 | |
| 1210 | 1/4W 1/2W-SS | 3.10±0.10 | 2.60 ^{+0.15} _{-0.10} | 0.55±0.10 | 0.50±0.25 | 0.50±0.20 | |

Performance Specification (性能)

| | | |
|---------------------------------|--------|---|
| Temperature coefficient | 温度系数 | ±200ppm/°C |
| Short time overload | 短时间过负荷 | ±(2.0%+0.1Ω) Max (最大) |
| Terminal bending | 端子弯曲 | ±(1.0%+0.05Ω) |
| Solderability | 可焊性 | Min 95% coverage (最少 95% 覆盖率) |
| Dielectric withstanding voltage | 绝缘耐压 | No evidence of flashover, mechanical damage, arcing or insulation breakdown (无击穿, 飞弧及可见机械性损伤) |
| Soldering heat | 耐焊接热 | ±(1.0%+0.05Ω) Max (最大) |
| Temperature cycling | 温度循环 | ±(1.0%+0.05Ω) Max (最大) |
| Load Life in humidity | 湿度寿命 | ±(3.0%+0.1Ω) Max (最大) |
| Load life | 负载寿命 | ±(3.0%+0.1Ω) Max (最大) |
| Humidity (steady state) | 恒定湿热 | ±(3.0%+0.1Ω) Max (最大) |
| Insulation resistance | 绝缘电阻 | ≥1,000 MΩ |

Feature (特性)

- Superior Anti-Surge Voltage performance.
优越的抗浪涌电压特性
- Suitable for both wave & re-flow soldering
适合波峰焊与回流焊
- Application AV adapters, LCD back-light camera strobe etc. 适用于AV适配器、LCD背光电路、照相机的快门等

Figures (型状)

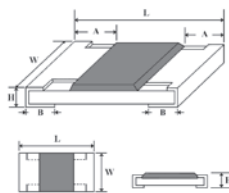

1. High purity Alumina substrate (高纯度氧化铝基板)
2. Protective coating (保护层)
3. Resistance element (阻抗元素)
4. Termination (Inner) Ni / Cr [端面(内)镍/铬层]
5. Termination (Between) Ni Barrier [端面(中)镍层]
6. Termination (Outer) Sn [端面(外)锡层(无铅)]

Derating Curve (降功率曲线)

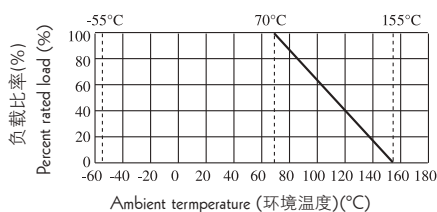

Curve of Pulse Duration (脉冲曲线)

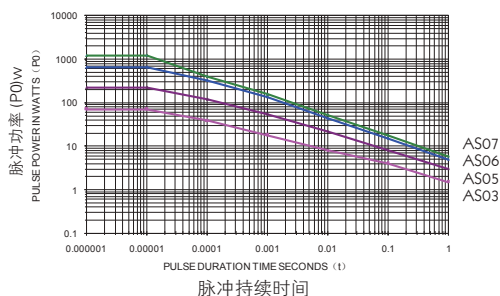

Specification (规格)

| Type 类型 | Max. Working Voltage 最大工作电压 | Max. Overload Voltage 最大过负荷电压 | Dielectric Withstanding Voltage 绝缘耐压 | Operating Temperature 工作温度范围 |
|------------|--------------------------------|----------------------------------|---|---------------------------------|
| AS03 | 50V | 100V | 300V | -55~+155°C |
| AS05 | 150V | 300V | 500V | |
| AS06 | 200V | 400V | 500V | |
| AS07 | 200V | 400V | 500V | |

| Type 类型 | Power (功率) (70°C) | L (mm) | W (mm) | H (mm) | A (mm) | B (mm) | Resistance Range 阻值范围 | Tolerance 公差 |
|------------|----------------------|-----------|--|-----------|-----------|-----------|--------------------------|---------------------|
| AS03 | 1/5W, 1/4W-S | 1.60±0.10 | 0.80 ^{+0.15} _{-0.10} | 0.45±0.10 | 0.30±0.20 | 0.30±0.20 | 1Ω~10M | ±5% ±10% ±20% |
| AS05 | 1/3W, 1/2W-S | 2.00±0.15 | 1.25 ^{+0.15} _{-0.10} | 0.55±0.10 | 0.40±0.20 | 0.40±0.20 | | |
| AS06 | 1/2W, 0.6W-S | 3.10±0.15 | 1.55 ^{+0.15} _{-0.10} | 0.55±0.10 | 0.45±0.20 | 0.45±0.20 | | |
| AS07 | 1/2W, 3/4W-S | 3.10±0.10 | 2.60 ^{+0.15} _{-0.10} | 0.55±0.10 | 0.50±0.25 | 0.50±0.20 | | |

Performance Specifications (性能)

| | | |
|---------------------------------|--------|--|
| Temperature coefficient | 温度系数 | 1Ω~10Ω:±400PPM/°C 11Ω~10M:±100PPM/°C |
| Short-time overload | 短时间过负荷 | ±(1.0%+0.1Ω) Max (最大) |
| Terminal bending | 端子弯曲 | ±(1.0%+0.05Ω) Max (最大) |
| Solderability | 可焊性 | Min 95% coverage (最少 95% 覆盖率) |
| Dielectric withstanding voltage | 绝缘耐压 | No evidence of flashover, mechanical damage, arcing or insulation breakdown 无击穿, 飞弧及可见机械性损伤 |
| Soldering heat | 耐焊接热 | ±(1.0%+0.05Ω) Max (最大) |
| Temperature cycling | 温度循环 | ±(1.0%+0.05Ω) Max (最大) |
| Load Life in humidity | 湿度寿命 | ±(3.0%+0.1Ω) Max (最大) |
| Load life | 负载寿命 | ±(3.0%+0.1Ω) Max (最大) |
| Humidity (steady state) | 恒定湿热 | ±(3.0%+0.1Ω) Max (最大) |
| Single pulse | 单脉冲 | ±(1.0%+0.1Ω) Max (最大) |

Ordering Procedure (Example: Anti-surge AS03 1/4WS 5% 10KΩ T/R-5000)

订购方式 (例如: 抗浪涌 AS03 1/4WS 5% 10KΩ T/R-5000)

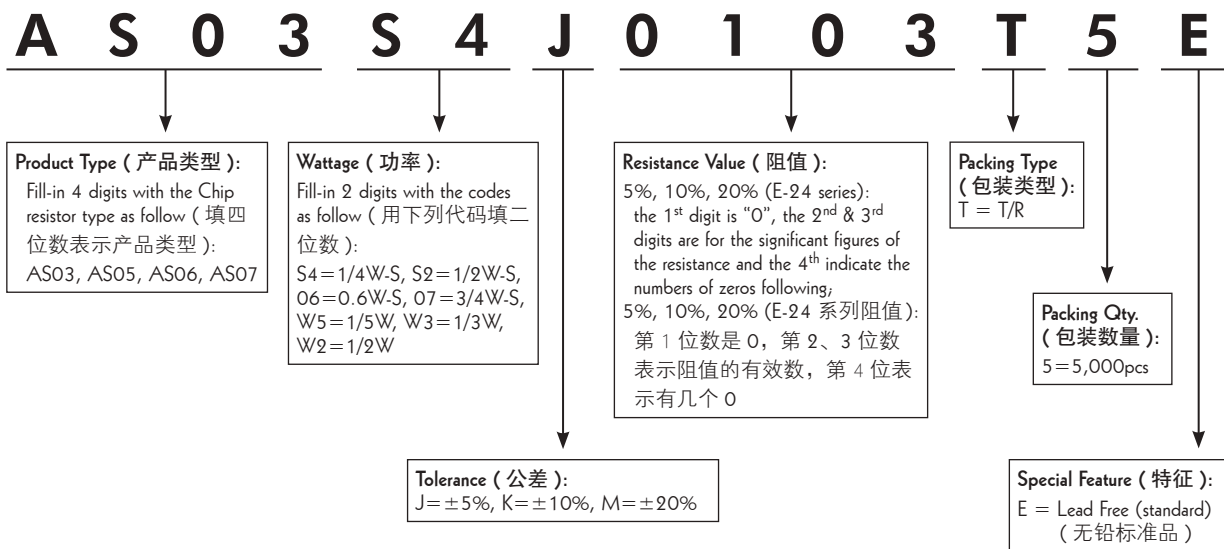

Feature (特性)

- High-Precision, high-power, anti-pulse 高精度、高功率、抗脉冲
- Suitable for reflow & wave soldering 适合波峰焊与回流焊
- Application monitors, power supplies, DVD, camcorder, laptop computer
适用于显示器、电源、DVD 摄像机、手提电脑

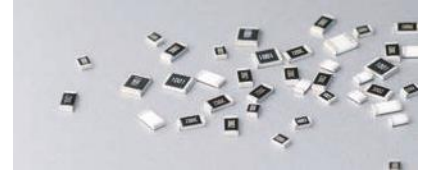

Figures (型状)

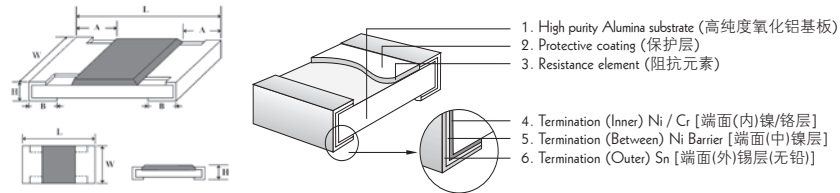

Derating Curve (降功率曲线)

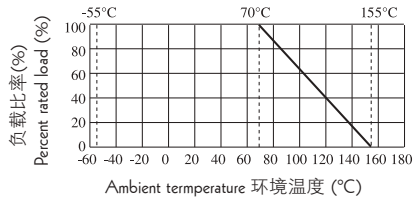

Curve of Pulse Duration (脉冲曲线)

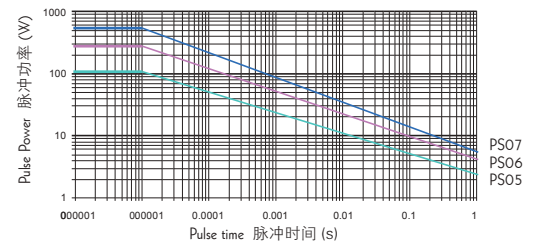

Specification (性能)

| Type 类型 | Max working voltage 最大工作电压 | Max Overload Voltage 最大过负荷电压 | Dielectric Withstanding Voltage 绝缘耐压 | | | Operating Temperature 工作温度范围 |
|------------|-------------------------------|---------------------------------|---|--|--|---------------------------------|
| PS05 | 150V | 300V | 500V | | | -55~+155°C |
| PS06 | 200V | 400V | 500V | | | |
| PS07 | 200V | 500V | 500V | | | |

| Type 类型 | Power 功率 (70°C) | L (mm) | W (mm) | H (mm) | A (mm) | B (mm) | Resistance Range 阻值范围 1%(E96), 5%(E24) |
|------------|--------------------|-----------|--|-----------|-----------|-----------|--|
| PS05 | 1/3W | 2.00±0.15 | 1.25 ^{+0.15} _{-0.10} | 0.55±0.10 | 0.40±0.20 | 0.40±0.20 | 1Ω~10M |
| PS06 | 1/2W | 3.10±0.15 | 1.55 ^{+0.15} _{-0.10} | 0.55±0.10 | 0.45±0.20 | 0.45±0.20 | |
| PS07 | 3/4W-S | 3.10±0.10 | 2.60 ^{+0.15} _{-0.10} | 0.55±0.10 | 0.55±0.25 | 0.50±0.20 | |

Performance Specification (性能)

| | | |
|---------------------------------|--------|---|
| Temperature coefficient | 温度系数 | PS05, PS06: $\leq 10\Omega: \pm 200\text{ppm}/^\circ\text{C}$ $> 10\Omega: \pm 100\text{ppm}/^\circ\text{C}$ PS07: $\pm 100\text{ppm}/^\circ\text{C}$ |
| Short-time overload | 短时间过负荷 | $\pm 1\%: \pm(1.0\%+0.1\Omega)\text{Max. (最大)}$ $\pm 5\%: \pm(2.0\%+0.1\Omega)\text{Max. (最大)}$ |
| Terminal bending | 端子弯曲 | $\pm(1.0\%+0.05\Omega)\text{Max. (最大)}$ |
| Solderability | 可焊性 | Min. 95% Coverage (最少 95% 覆盖率) |
| Soldering heat | 耐焊接热 | $\pm(1.0\% + 0.05\Omega)\text{Max. (最大)}$ |
| Load life in humidity | 湿度寿命 | $\pm 1\%: \pm(1.0\%+0.1\Omega)\text{Max. (最大)}$ $\pm 5\%: \pm(3.0\%+0.1\Omega)\text{Max. (最大)}$ |
| Dielectric withstanding voltage | 绝缘耐压 | No evidence of flashover, mechanical damage, arcing or insulation breakdown 无击穿, 飞弧及可见机械性损伤 |
| Temperature Cycling | 温度循环 | $\pm 1\%: \pm(0.5\%+0.1\Omega)\text{Max. (最大)}$ $\pm 5\%: \pm(3.0\%+0.1\Omega)\text{Max. (最大)}$ |
| Load life | 负载寿命 | $\pm 1\%: \pm(1.0\%+0.1\Omega)\text{Max. (最大)}$ $\pm 5\%: \pm(3.0\%+0.1\Omega)\text{Max. (最大)}$ |
| Single pulse | 单脉冲 | $\pm(1.0\%+0.1\Omega)\text{Max. (最大)}$ |

Ordering Procedure (Example: PS05 1/3W 5% 120K Ω T/R-5000)

订购方式 (例如: PS05 1/3W 5% 120K Ω T/R-5000)

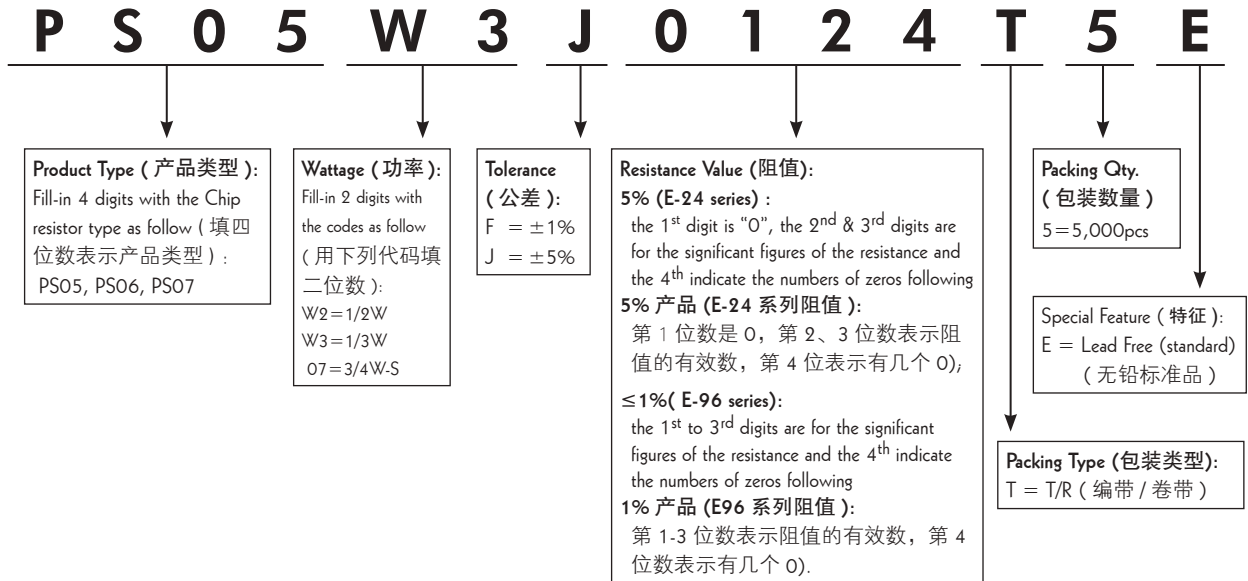

Feature (特性)

- High power in standard size
标准尺寸，高功率
- Suitable for both wave & re-flow soldering
适合波峰焊与回流焊
- Application: AV adapters, LCD back-light, camera strobe etc. 适用于AV适配器, LCD 背光电路, 照相机快门等

Figures (型状)

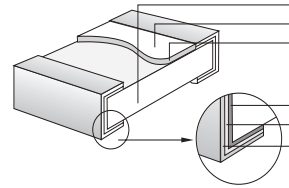

1. High purity Alumina substrate (高纯度氧化铝基板)
2. Protective coating (保护层)
3. Resistance element (阻抗元素)
4. Termination (Inner) Ni / Cr [端面(内)镍/铬层]
5. Termination (Between) Ni Barrier [端面(中)镍层]
6. Termination (Outer) Sn [端面(外)锡层(无铅)]

Derating Curve & Specification (降功率曲线及性能)



| Type 类型 | Max. Working Voltage 最大工作电压 | Max. Overload Voltage 最大过负荷电压 | Dielectric Withstanding Voltage 绝缘耐压 | Operating Temperature 工作温度范围 |
|------------|--------------------------------|----------------------------------|---|---------------------------------|
| HP02 | 50V | 100V | 100V | -55°C~155°C |
| HP03 | 50V | 100V | 300V | -55°C~155°C |
| HP05 | 150V | 300V | 500V | -55°C~155°C |
| HP06 | 200V | 400V | 500V | -55°C~155°C |
| HP07 | 200V | 500V | 500V | -55°C~155°C |
| HP10 | 200V | 500V | 500V | -55°C~155°C |
| HP12 | 250V | 500V | 500V | -55°C~155°C |

| Type 类型 | Power Rating at 70°C 功率 | L(mm) | W(mm) | H(mm) | A(mm) | B(mm) | Resistance Range of 1% 1%的阻值范围 | Resistance Range of 5% 5%的阻值范围 |
|------------|----------------------------|-----------|--|-----------|-----------|-----------|-----------------------------------|-----------------------------------|
| HP02 | 1/10W | 1.00±0.10 | 0.50 ^{+0.05} _{-0.05} | 0.35±0.05 | 0.20±0.10 | 0.25±0.10 | 1Ω~10M | 1Ω~10M |
| HP03 | 1/5W | 1.60±0.10 | 0.80 ^{+0.15} _{-0.10} | 0.45±0.10 | 0.30±0.20 | 0.30±0.20 | 1Ω~10M | 1Ω~10M |
| HP05 | 1/3W | 2.00±0.15 | 1.25 ^{+0.15} _{-0.10} | 0.55±0.10 | 0.40±0.20 | 0.40±0.20 | 1Ω~10M | 1Ω~10M |
| HP06 | 1/2W | 3.10±0.15 | 1.55 ^{+0.15} _{-0.10} | 0.55±0.10 | 0.45±0.20 | 0.45±0.20 | 1Ω~10M | 1Ω~10M |
| HP07 | 3/4W | 3.10±0.10 | 2.60 ^{+0.15} _{-0.10} | 0.55±0.10 | 0.50±0.25 | 0.50±0.20 | 1Ω~10M | 1Ω~10M |
| HP10 | 1W | 5.00±0.10 | 2.50 ^{+0.15} _{-0.10} | 0.55±0.10 | 0.60±0.25 | 0.50±0.20 | 1Ω~10M | 1Ω~10M |
| HP12 | 2W | 6.35±0.10 | 3.20 ^{+0.15} _{-0.10} | 0.55±0.10 | 0.60±0.25 | 1.80±0.25 | 1Ω~10M | 1Ω~10M |

Performance Specifications (性能)

| | | |
|---------------------------------|--------|--|
| Temperature coefficient | 温度系数 | 1Ω~10Ω ≤ ±200PPM/°C 11Ω~10MΩ ≤ ±100PPM/°C |
| Short-time overload | 短时间过负荷 | ±5%: ±(2.0% + 0.1Ω) Max.(最大) ±1%: ±(1.0% + 0.1Ω) Max.(最大) |
| Dielectric withstanding voltage | 绝缘耐压 | No Evidence of flashover, mechanical damage, arcing or insulation breakdown 无击穿, 飞弧及可见机械性损伤 |
| Terminal bending | 端子弯曲 | ±(1.0% + 0.05Ω) Max.(最大) |
| Soldering heat | 耐焊接热 | ±(1.0% + 0.05Ω) Max.(最大) |
| Solderability | 可焊性 | Min. 95% Coverage (最少 95% 覆盖率) |
| Temperature cycling | 温度循环 | ±5%: ±(1.0% + 0.05Ω) Max.(最大) ±1%: ±(0.5% + 0.05Ω) Max.(最大) |
| Humidity (Steady state) | 恒定湿热 | ±5%: ±(3.0% + 0.1Ω) Max.(最大) ±1%: ±(0.5% + 0.1Ω) Max.(最大) |
| Load life in humidity | 湿度寿命 | ±5%: ±(3.0% + 0.1Ω) Max.(最大) ±1%: ±(1.0% + 0.1Ω) Max.(最大) |
| Load life | 负载寿命 | ±5%: ±(3.0% + 0.1Ω) Max.(最大) ±1%: ±(1.0% + 0.1Ω) Max.(最大) |

* HP02 TCR: 1Ω~10Ω: ±400PPM/°C 11Ω~100Ω: ±200PPM/°C >100Ω: ±100PPM/°C

Ordering Procedure (Example: High Power HP06 1/2W 5% 120KΩ T/R-5000)

订购方式 (例如: 高功率 HP06 1/2W 5% 120KΩ T/R-5000)

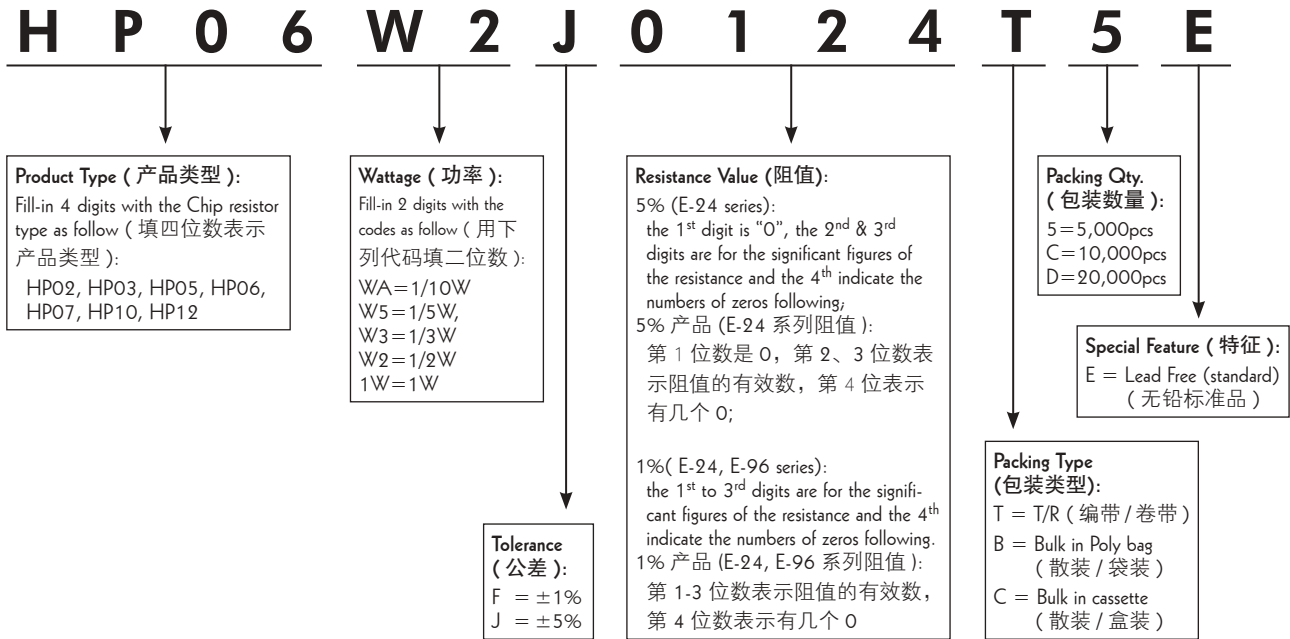

Feature (特性)

- Low Resistance High power
低阻值，高功率
- Suitable for reflow & wave soldering
适合波峰焊与回流焊
- Application AV adapters, LCD back-light camera strobe etc. 适用于AV适配器, LCD背光电路, 照相机快门等

Figures (型状)

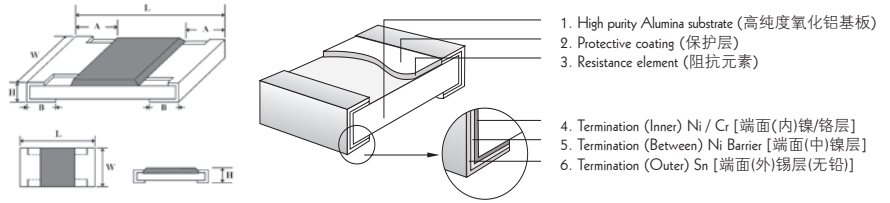

Derating Curve & Specification (降功率曲线及性能)

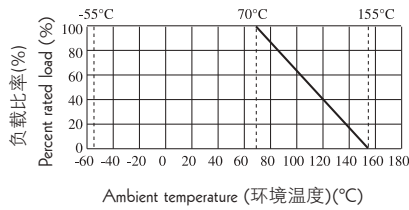

| Type 类型 | Max. Working Voltage 最大工作电压 | Max. Overload Voltage 最大过负荷电压 | Dielectric Withstanding Voltage 绝缘耐压 | Operating Temperature 工作温度范围 |
|------------|--------------------------------|----------------------------------|---|---------------------------------|
| HP03 | 50V | 100V | 300V | -55~+155°C |
| HP05 | 150V | 300V | 500V | |
| HP06 | 200V | 400V | 500V | |
| HP07 | 200V | 500V | 500V | |
| HP10 | 200V | 500V | 500V | |
| HP12 | 250V | 500V | 500V | |

| Type 类型 | Power 功率 (70°C) | L (mm) | W (mm) | H (mm) | A (mm) | B (mm) | Resistance Range 阻值范围 1% & 5% |
|------------|--------------------|-----------|--|-----------|-----------|-----------|-------------------------------------|
| HP03 | 1/5W | 1.60±0.10 | 0.80 ^{+0.15} _{-0.10} | 0.45±0.10 | 0.30±0.20 | 0.30±0.20 | 0.1Ω~1Ω |
| HP05 | 1/3W | 2.00±0.15 | 1.25 ^{+0.15} _{-0.10} | 0.55±0.10 | 0.40±0.20 | 0.40±0.20 | |
| HP06 | 1/2W | 3.10±0.15 | 1.55 ^{+0.15} _{-0.10} | 0.55±0.10 | 0.45±0.20 | 0.45±0.20 | |
| HP07 | 3/4W | 3.10±0.10 | 2.60 ^{+0.15} _{-0.10} | 0.55±0.10 | 0.50±0.25 | 0.50±0.20 | |
| HP10 | 1W | 5.00±0.10 | 2.50 ^{+0.15} _{-0.10} | 0.55±0.10 | 0.60±0.25 | 0.50±0.20 | |
| HP12 | 2W | 6.35±0.10 | 3.20 ^{+0.15} _{-0.10} | 0.55±0.10 | 0.60±0.25 | 1.80±0.25 | |

Performance Specification (性能)

| | | |
|---------------------------------|--------|--|
| Temperature coefficient | 温度系数 | HP03: ±200ppm/°C HP05: ±200ppm/°C HP06: ±100ppm/°C HP07: ±100ppm/°C HP10: ±100ppm/°C HP12: ±100ppm/°C |
| Short time overload | 短时间过负荷 | 1%: ±(1.0%+0.1Ω) Max (最大) 5%: ±(2.0%+0.1Ω) Max (最大) |
| Terminal bending | 端子弯曲 | ±(1.0%+0.05Ω) |
| Solderability | 可焊性 | ≥95% coverage (最少 95% 覆盖率) |
| Dielectric withstanding voltage | 绝缘耐压 | No evidence of flashover, mechanical damage, arcing or insulation breakdown 无击穿, 飞弧及可见机械性损伤 |
| Soldering heat | 耐焊接热 | ±(1.0%+0.05Ω) Max (最大) |
| Temperature cycling | 温度循环 | 1%: ±(0.5%+0.05Ω) Max (最大) 5%: ±(1.0%+0.05Ω) Max (最大) |
| Load Life in humidity | 湿度寿命 | 1%: ±(1.0%+0.1Ω) Max (最大) 5%: ±(3.0%+0.1Ω) Max (最大) |
| Load life | 负载寿命 | 1%: ±(1.0%+0.1Ω) Max (最大) 5%: ±(3.0%+0.1Ω) Max (最大) |
| Humidity (steady state) | 恒定湿热 | 1%: ±(0.5%+0.1Ω) Max (最大) 5%: ±(3.0%+0.1Ω) Max (最大) |

• HP10, HP12 T.C.R ±75ppm/°C could be provided specially (*HP10, HP12 T.C.R ±75ppm/°C 可特别提供)

Feature (特性)

- Superior to Thick Film Chip Resistors in Max. Working Voltage 在最大工作电压上优于普通厚膜晶片电阻
- Suitable for both wave & re-flow soldering 适合波峰焊及回流焊
- Application: AV adapter, LCD Backlight, Flash Light of camera 适用于AV适配器、LCD背光电路、照相机的闪光灯等

Figures (型状)

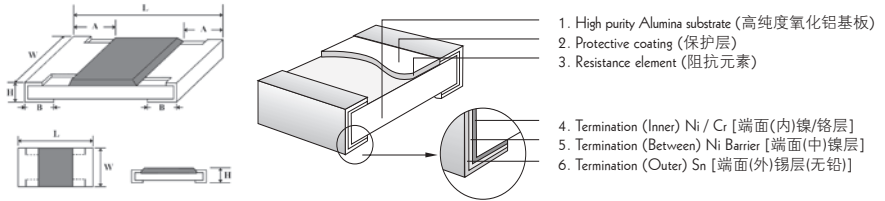

Derating Curve & Specification (降功率曲线及性能)

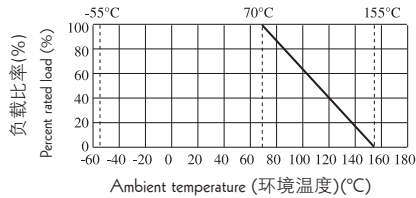

| Type 类型 | Max. Working Voltage 最大工作电压 | Max. Overload Voltage 最大过负荷电压 | Dielectric Withstanding Voltage 绝缘耐压 | Operating Temperature 工作温度范围 |
|------------|--------------------------------|----------------------------------|---|---------------------------------|
| HV03 | 200V | 400V | 300V | -55°C~155°C |
| HV05 | 400V | 800V | 500V | -55°C~155°C |
| HV06 | 500V | 1000V | 500V | -55°C~155°C |
| HV07 | 800V | 1500V | 500V | -55°C~155°C |
| HV10 | 2000V | 3000V | 500V | -55°C~155°C |
| HV12 | 3000V | 4000V | 500V | -55°C~155°C |

| Type 类型 | Power Rating 功率 at 70°C | L(mm) | W(mm) | H(mm) | A(mm) | B(mm) | Resistance Range 阻值范围 1% & 5% |
|------------|-------------------------------|-----------|--|-----------|-----------|-----------|-------------------------------------|
| HV03 | 1/16W, 1/10W-S | 1.60±0.10 | 0.80 ^{+0.15} _{-0.10} | 0.45±0.10 | 0.30±0.20 | 0.30±0.20 | 100KΩ~10MΩ |
| HV05 | 1/10W, 1/8W-S | 2.00±0.15 | 1.25 ^{+0.15} _{-0.10} | 0.55±0.10 | 0.40±0.20 | 0.40±0.20 | |
| HV06 | 1/8W, 1/4W-S | 3.10±0.15 | 1.55 ^{+0.15} _{-0.10} | 0.55±0.10 | 0.45±0.20 | 0.45±0.20 | |
| HV07 | 1/3W-S, 1/2W-SS | 3.10±0.10 | 2.60 ^{+0.15} _{-0.10} | 0.55±0.10 | 0.50±0.25 | 0.50±0.20 | 50KΩ~10MΩ |
| HV10 | 1/2W, 3/4W-S | 5.00±0.10 | 2.50 ^{+0.15} _{-0.10} | 0.55±0.10 | 0.60±0.25 | 0.50±0.20 | |
| HV12 | 1W | 6.35±0.10 | 3.20 ^{+0.15} _{-0.10} | 0.55±0.10 | 0.60±0.25 | 0.50±0.20 | |

The non-standard value can be offered on a case to case basis. 特殊规格可特别提供

Performance Specification (性能)

| | | |
|---------------------------------|--------|--|
| Temperature coefficient | 温度系数 | ±200PPM/°C |
| Short-time overload | 短时间过负荷 | ±(2.0%+0.1Ω) Max.(最大) |
| Terminal bending | 端子弯曲 | ±(1.0%+0.05Ω) Max.(最大) |
| Solderability | 可焊性 | Min. 95% Coverage (最少 95% 覆盖率) |
| Temperature Cycling | 温度循环 | 5% : ±(1.0%+0.05Ω) Max.(最大) 1% : ±(0.5%+0.05Ω) Max.(最大) |
| Humidity (steady State) | 恒定湿热 | ±(3.0%+0.1Ω) Max.(最大) |
| Load life in humidity | 湿度寿命 | ±(3.0%+0.1Ω) Max.(最大) |
| Load life | 负载寿命 | ±(3.0%+0.1Ω) Max.(最大) |
| Insulation resistance | 绝缘电阻 | ≥1,000MΩ |
| Dielectric withstanding voltage | 绝缘耐压 | No evidence of flashover, mechanical damage, arcing or insulation breakdown 无击穿, 飞弧及可见机械性损伤 |
| Soldering heat | 耐焊接热 | ±(1.0% + 0.05Ω) Max.(最大) |

Ordering Procedure (Example: High Voltage HV06 1/4WS 5% 120KΩ T/R-5000)

订购方式 (例如: 高压 HV06 1/4W-S 5% 120KΩ T/R-5000)

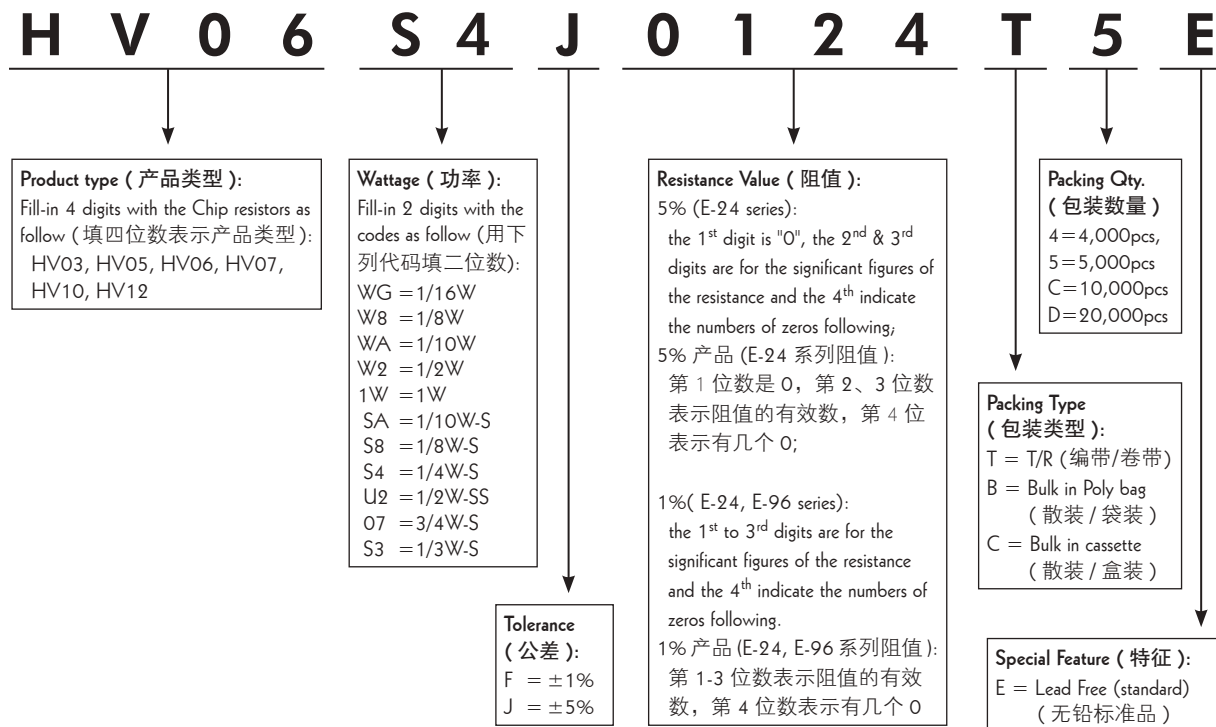

Feature (特性)

- High power & Wide terminal
高功率，宽电极
- Suitable for both wave & re-flow soldering
适合波峰焊及回流焊
- Application: AV adapters, LCD back-light, camera strobe etc. 适用于AV适配器, LCD背光电路, 照相机快门等

Figures (型状)

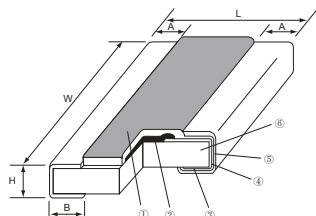

1. Protective layer (保护层)
2. Resistive element (阻抗元素)
3. Termination (Inner) Ni / Cr [端面(内)镍/铬层]
4. Termination (Between) Ni [端面(中)镍层]
5. Termination (Outer) Sn [端面(外)锡层(无铅)]
6. High purity Alumina substrate (高纯度氧化铝基板)

Derating Curve & Specification (降功率曲线及性能)

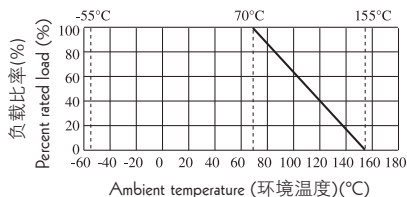

| Type 类型 | Max. Working Voltage 最大工作电压 | Max. Overload Voltage 最大过负荷电压 | Dielectric Withstanding Voltage 绝缘耐压 | Operating Temperature 工作温度范围 |
|------------|--------------------------------|----------------------------------|---|---------------------------------|
| 0508 | 150V | 300V | 500V | -55°C~155°C |
| 0612 | 200V | 400V | 500V | -55°C~155°C |
| 1020 | 200V | 400V | 500V | -55°C~155°C |
| 1218 | 200V | 400V | 500V | -55°C~155°C |
| 1225 | 200V | 400V | 500V | -55°C~155°C |

| Type 类型 | Power Rating 功率 at 70°C | L(mm) | W(mm) | H(mm) | A(mm) | B(mm) | Resistance Range 阻值范围 1% | Resistance Range 阻值范围 5% |
|------------|-------------------------------|-----------|-----------|-----------|-----------|-----------|--------------------------------|--------------------------------|
| 0508 | 1/3W | 1.20±0.10 | 2.00±0.10 | 0.55±0.10 | 0.20±0.10 | 0.30±0.20 | 10Ω~1M | 10Ω~1M |
| 0612 | 1/2W | 1.60±0.15 | 3.20±0.15 | 0.55±0.10 | 0.30±0.20 | 0.45±0.20 | 10Ω~1M | 1Ω~1M |
| 1020 | 1W | 2.50±0.15 | 5.00±0.15 | 0.55±0.10 | 0.40±0.20 | 0.60±0.20 | 10Ω~1M | 1Ω~1M |
| 1218 | 1W | 3.10±0.10 | 4.60±0.15 | 0.55±0.10 | 0.45±0.20 | 0.40±0.20 | 1Ω~1M | 1Ω~1M |
| 1225 | 1.5W | 3.10±0.15 | 6.25±0.15 | 0.55±0.10 | 0.45±0.20 | 0.65±0.20 | 1Ω~1M | 1Ω~1M |

Performance Specification (性能)

| | | |
|---------------------------------|--------|--|
| Temperature coefficient | 温度系数 | 1Ω~10Ω ≤ ±400PPM/°C 11Ω~100Ω ≤ ±200PPM/°C >100Ω ±100PPM/°C |
| Short-time overload | 短时间过负荷 | ±5%: ±(2.0% + 0.1Ω) Max. (最大) ±1%: ±(1.0% + 0.1Ω) Max. (最大) |
| Dielectric withstanding Voltage | 绝缘耐压 | No evidence of flashover, mechanical damage, arcing or insulation breakdown 无击穿, 飞弧及可见机械性损伤 |
| Terminal bending | 端子弯曲 | ±(1.0% + 0.05Ω) Max. (最大) |
| Soldering heat | 耐焊接热 | ±(1.0% + 0.05Ω) Max. (最大) |
| Solderability | 可焊性 | Min. 95% coverage (最少 95% 覆盖率) |
| Temperature cycling | 温度循环 | ±5%: ±(1.0% + 0.05Ω) Max. (最大) ±1%: ±(0.5% + 0.05Ω) Max. (最大) |
| Humidity (Steady State) | 恒定湿热 | ±5%: ±(3.0% + 0.1Ω) Max. (最大) ±1%: ±(0.5% + 0.1Ω) Max. (最大) |
| Load life in humidity | 湿度寿命 | ±5%: ±(3.0% + 0.1Ω) Max. (最大) ±1%: ±(1.0% + 0.1Ω) Max. (最大) |
| Load life | 负载寿命 | ±5%: ±(3.0% + 0.1Ω) Max. (最大) ±1%: ±(1.0% + 0.1Ω) Max. (最大) |

Ordering Procedure (Example: Wide Terminal 1218 1W 5% 120KΩ T/R-4000)

订购方式 (例如: 宽电极 1218 1W 5% 120KΩ T/R-4000)



Feature (特性)

- Apply to stable circuit instead of regulating circuit to adjust the application of resistance (laser adjusting resistance machine in client end)
适用于稳定电路中，代替调节电路来调节阻值的应用(客户端激光调阻机)
- Superior heat & humidity withstanding performance
良好的耐高温耐湿性

Figures (形状)

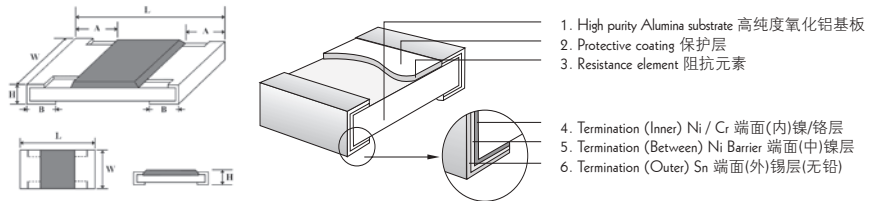

Derating Curve & Specification (降功率曲线及性能)

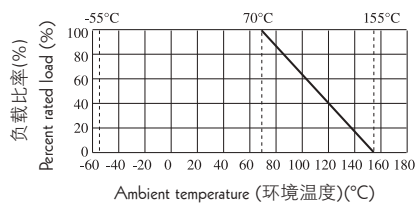

| Type 类型 | Max. Working Voltage 最大工作电压 | Max. Overload Voltage 最大过负荷电压 | Operating Temperature 工作温度范围 |
|---------|-----------------------------|-------------------------------|------------------------------|
| TR03 | 50V | 100V | -55°C~155°C |
| TR05 | 150V | 300V | -55°C~155°C |
| TR06 | 200V | 400V | -55°C~155°C |

| Type 类型 | Power Rating 功率 70°C | L(mm) | W(mm) | H(mm) | A(mm) | B(mm) | Tolerance 公差 | Resistance Range 阻值范围 (E-12) |
|---------|----------------------|-----------|--|-----------|-----------|-----------|---|------------------------------|
| TR03 | 1/16W, 1/10W-S | 1.60±0.10 | 0.80 ^{+0.15} _{-0.10} | 0.45±0.10 | 0.30±0.20 | 0.30±0.20 | R: 0~30% Q: 0~20% T: 0~10% S: -10~0% N: -20~0% P: -30~0% K: ±10% M: ±20% | 1Ω~1M |
| TR05 | 1/10W, 1/8W-S | 2.00±0.15 | 1.25 ^{+0.15} _{-0.10} | 0.55±0.10 | 0.40±0.20 | 0.40±0.20 | | |
| TR06 | 1/8W, 1/4W-S | 3.10±0.15 | 1.55 ^{+0.15} _{-0.10} | 0.55±0.10 | 0.45±0.20 | 0.45±0.20 | | |

Performance Specification (性能)

| | |
|------------------------------|--|
| Temperature coefficient 温度系数 | TR03: 1Ω~10Ω: ±400PPM/°C >10Ω: ±200PPM/°C TR05, TR06: ±200PPM/°C |
| Short-time overload 短时间过负荷 | ±(2.0%+0.1Ω) Max.(最大) |
| Terminal bending 端子弯曲 | ±(1.0%+0.05Ω) Max.(最大) |
| Solderability 可焊性 | Min. 95% coverage (最少 95% 覆盖率) |
| Soldering heat 耐焊接热 | ±(1.0%+0.05Ω) Max.(最大) |
| Temperature cycling 温度循环 | ±(1.0%+0.05Ω) Max.(最大) |
| Load life in humidity 湿度寿命 | ±(3.0%+0.1Ω) Max.(最大) |
| Load life 负载寿命 | ±(3.0%+0.1Ω) Max.(最大) |

Ordering Procedure (Example: Trimmable TR06 1/4W-S $\pm 20\%$ 120K Ω T/R-5000)

订购方式 (例如: 可调 TR06 1/4W-S $\pm 20\%$ 120K Ω T/R-5000)

The values which are not of standard E-12 series could be offered on a case to case basis.

阻值如不在 E-12 系列的可特别提供。

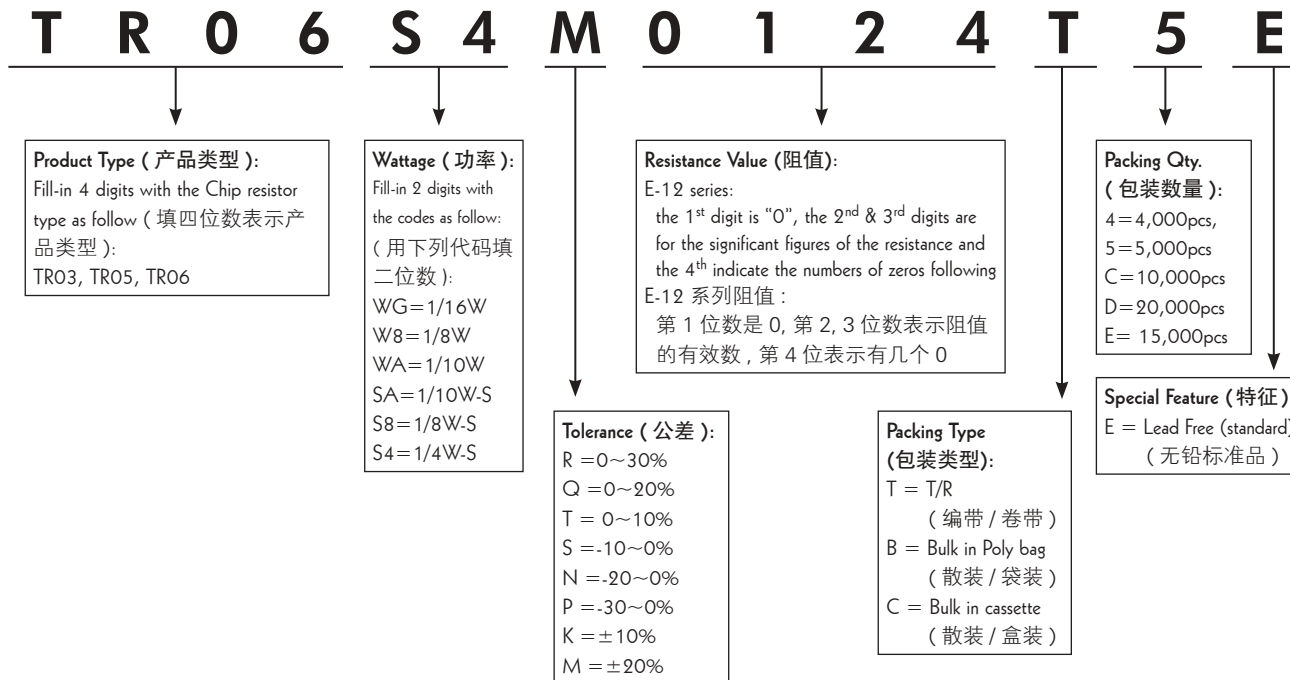

Feature (特性)

- Ultra-low Value
超低阻值
- Low Temperature Coefficient
低温度系数
- Suitable for reflow & wave soldering
适合波峰焊及回流焊
- Application: Power supply
应用于电源

Figures (型状)



Derating Curve & Specification (降功率曲线及性能)

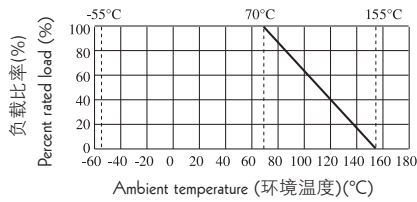

| Type 类型 | Dielectric Withstanding Voltage 绝缘耐压 | Operating Temperature 工作温度范围 |
|------------|---|---------------------------------|
| CS03 | 300V | -55°C~155°C |
| CS05 | 500V | -55°C~155°C |
| CS06 | 500V | -55°C~155°C |
| CS07 | 500V | -55°C~155°C |
| CS10 | 500V | -55°C~155°C |
| CS12 | 500V | -55°C~155°C |

| Type 类型 | Power Rating 功率 70°C | L(mm) | W(mm) | H(mm) | A(mm) | B(mm) | Resistance Range 阻值范围 1% & 5% | T.C.R. 温度系数 |
|------------|----------------------------|-------------|--|-----------|-----------|-----------|-------------------------------------|--|
| CS03 | 1/10W 1/5W-S | 1.60±0.10 | 0.80 ^{+0.15} / _{-0.10} | 0.45±0.10 | 0.30±0.20 | 0.30±0.20 | 33mΩ~1Ω | 33~50mΩ: ≤±500ppm/°C 50.1mΩ~0.1Ω: ≤±400ppm/°C 0.11Ω~0.5Ω: ≤±300ppm/°C 0.51Ω~1Ω: ≤±200ppm/°C |
| CS05 | 1/8W 1/4W-S | 2.00±0.15 | 1.25 ^{+0.15} / _{-0.10} | 0.55±0.10 | 0.40±0.20 | 0.40±0.20 | 20mΩ~1Ω | 20mΩ~25mΩ: ≤±600ppm/°C 25.1mΩ~0.1Ω: ≤±400ppm/°C 0.11Ω~0.5Ω: ≤±300ppm/°C 0.51Ω~1Ω: ≤±200ppm/°C |
| CS06 | 1/4W 1/3W-S | 3.10±0.15 | 1.55 ^{+0.15} / _{-0.10} | 0.55±0.10 | 0.45±0.20 | 0.45±0.20 | 20mΩ~1Ω | 20mΩ~50mΩ: ≤±400ppm/°C 50.1mΩ~0.1Ω: ≤±300ppm/°C 0.11Ω~1Ω: ≤±200ppm/°C |
| CS07 | 1/3W 1/2W-S | 3.10+/-0.10 | 2.60 ^{+0.15} / _{-0.10} | 0.55±0.10 | 0.50±0.25 | 0.50±0.20 | 20mΩ~1Ω | 20mΩ~50mΩ: ≤±400ppm/°C 50.1mΩ~1Ω: ≤±200ppm/°C |
| CS10 | 1/2W 3/4W-S | 5.00±0.10 | 2.50 ^{+0.15} / _{-0.10} | 0.55±0.10 | 0.60±0.25 | 0.50±0.20 | | |
| CS12 | 1W | 6.35±0.10 | 3.20 ^{+0.15} / _{-0.10} | 0.55±0.10 | 0.60±0.25 | 0.80±0.30 | 10mΩ~1Ω | 10mΩ~19mΩ: ±600ppm/°C 20mΩ~50mΩ: ≤±400ppm/°C 50.1mΩ~1Ω: ≤±200ppm/°C |

Performance Specifications (性能)

| | |
|---|---|
| Short-time overload 短时间过负荷 | 1%: ±(1.0%+0.005Ω) Max. (最大) 5%: ±(2.0%+0.005Ω) Max. (最大) |
| Terminal bending 端子弯曲 | ±(1.0%+0.005Ω) Max. (最大) |
| Solderability 可焊性 | Min. 95% coverage (最少95%覆盖率) |
| Dielectric withstanding Voltage 绝缘耐压 | No evidence of flashover, mechanical damages, arcing or insulation breakdown 无击穿, 电弧及可见机械性损伤 |
| Temperature cycling 温度循环 | ±(1.0%+0.005Ω) Max. (最大) |
| Soldering heat 耐焊接热 | ±(1.0%+0.005Ω) Max. (最大) |
| Load life in humidity 湿度寿命 | 1%: ±(1.0%+0.005Ω) Max. (最大) 5%: ±(3.0%+0.005Ω) Max. (最大) |
| Load life 负载寿命 | 1%: ±(1.0%+0.005Ω) Max. (最大) 5%: ±(3.0%+0.005Ω) Max. (最大) |

* CS07 size in 0.75W 0.1~1Ω 100PPM/°C could be provided specially (* CS07 0.75W 0.1~1Ω 100PPM/°C 可特别提供)

* CS12 size in 1W 50.1mΩ~0.1Ω T.C.R ±100ppm/°C could be provided specially(* CS12 1W 50.1mΩ~0.1Ω T.C.R ±100ppm/°C 可特别提供)

Ordering Procedure (Example: CS12 1W 5% 22mΩ T/R-4000)

订购方式 (例如: CS12 1W 5% 22mΩ T/R-4000)



Feature (特性)

- The relevant provisions of the AEC-Q200. 符合AEC-Q200相关条款
- Suitable for reflow & wave soldering. 适合波峰焊与回流焊
- Application car. 适用于汽车

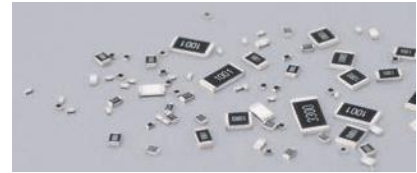

Figures (型状)



Derating Curve 降功率曲线

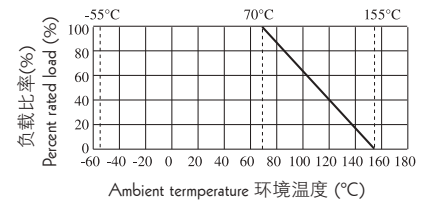

Specification (性能)

| Type 类型 | Max working voltage 最大工作电压 | Max Overload Voltage 最大过负荷电压 | Resistance Value of Jumper 零欧姆电阻阻值 | Rated Current Of Jumper 零欧姆电阻 额定电流 | Max. Current Of Jumper 零欧姆电阻 最大电流 | Operating Temperature 工作温度范围 |
|------------|----------------------------------|------------------------------------|--|---|--|------------------------------------|
| HQ02 | 50V | 100V | / | / | / | -55~+155°C |
| HQ03 | 50V | 100V | < 20mΩ | 1A | 2A | |
| HQ05 | 150V | 300V | < 20mΩ | 2A | 5A | |
| HQ06 | 200V | 400V | < 20mΩ | 2A | 10A | |
| HQ07 | 200V | 500V | < 20mΩ | 2A | 10A | |
| HQ10 | 200V | 500V | < 20mΩ | 2A | 10A | |
| HQ12 | 200V | 500V | / | / | / | |

| Type 类型 | Power 功率 (70°C) | L (mm) | W (mm) | H (mm) | A (mm) | B (mm) | Resistance Range 阻值范围 1%(E96), 5%(E24) |
|------------|--------------------|-----------|--|-----------|-----------|-----------|--|
| HQ02 | 1/16W | 1.00±0.10 | 0.50±0.05 | 0.35±0.05 | 0.20±0.10 | 0.25±0.10 | 1Ω~10M |
| HQ03 | 1/16W (1/10W-S) | 1.60±0.10 | 0.80 ^{+0.15} _{-0.10} | 0.45±0.10 | 0.30±0.20 | 0.30±0.20 | |
| HQ05 | 1/10W (1/8W-S) | 2.00±0.15 | 1.25 ^{+0.15} _{-0.10} | 0.55±0.10 | 0.40±0.20 | 0.40±0.20 | |
| HQ06 | 1/8W (1/4W-S) | 3.10±0.15 | 1.55 ^{+0.15} _{-0.10} | 0.55±0.10 | 0.45±0.20 | 0.45±0.20 | |
| HQ07 | 1/4W (1/3W-S) | 3.10±0.10 | 2.60 ^{+0.15} _{-0.10} | 0.55±0.10 | 0.50±0.25 | 0.50±0.20 | |
| HQ10 | 1/2W (3/4W-S) | 5.00±0.10 | 2.50 ^{+0.15} _{-0.10} | 0.55±0.10 | 0.60±0.25 | 0.50±0.20 | |
| HQ12 | 1W | 6.35±0.10 | 3.20 ^{+0.15} _{-0.10} | 0.55±0.10 | 0.60±0.25 | 0.50±0.20 | |

Performance Specification (性能)

| 试验项目 Test Item | 试验方法 Test Methods | 判定标准 Determine Specification |
|---|---|--|
| 温度系数 Temperature coefficient | 测定范围: -55°C ~ +125°C Measure between: -55°C ~ +125°C | 1Ω ≤ R ≤ 10 Ω: ≤ ±400ppm/°C 11Ω < R ≤ 100 Ω: ≤ ±200ppm/°C 100Ω < R ≤ 10MΩ: ≤ ±100ppm/°C |
| 短时间过负荷 Short-time overload | 2.5 倍额定电压或最大过负荷电压 (取其低者), 持续 5 秒钟, 然后测阻值。 2.5x Rated voltage or Max. Overload Voltage whichever is lower for 5 seconds, then check the resistance. | ±1%: ±(1.0%+0.1Ω)Max (最大) ±5%: ±(2.0%+0.1Ω)Max (最大) |
| 端子弯曲 Terminal Bending | 弯曲距离 (Bending Distance): 5mm, 保持时间: 60s ± 5s, 然后测试阻值。 Duration: 60s ± 5s, then check the resistance. | ±(1.0%+0.05Ω)Max (最大) |
| 可焊性 Solderability | 245 ± 3°C, 2~3 秒 245 ± 3°C, 2~3s | 覆盖率 ≥ 95% 95% coverage Min |
| 耐焊接热 Soldering heat | 260 ± 5°C, 10 ± 1 秒 260 ± 5°C, 10 ± 1s | ±(1.0%+0.05Ω) Max (最大) |
| 耐湿性 Moisture Resistance | 25°C ~ 65°C, 90~100%RH, 2.5 小时; 65°C 90~100%RH, 3 小时; 65°C ~ 25°C, 80~100%RH, 2.5 小时, 10 个循环, 试验结束 24 小时后进行测试。 25°C ~ 65°C, 90~100%RH, 2.5H, 65°C 90~100%RH, 3H, 65°C ~ 25°C 80~100%RH, 2.5H, 10 cycles, Measurement at 24 hours after test conclusion MIL-STD-202 Method 106 | ±1%: ±(0.5%+0.1Ω)Max (最大) ±5%: ±(3.0%+0.1Ω) Max (最大) |
| 偏置湿度 Biased Humidity | 10% 额定功率, 85°C/85%RH, 持续通电 1000 小时, 试验结束 24 小时后进行测试。 10% rated power, 85°C/85%RH, 1000H, Measurement at 24 hours after test conclusion MIL-STD-202 Method 103 | ±1%: ±(1.0%+0.1Ω)Max (最大) ±5%: ±(3.0%+0.1Ω) Max (最大) |
| 绝缘耐压 Dielectric withstanding voltage | 电阻固定在 90°C 的 V 型槽中, 根据不同产品规定交流电压, 持续 60~70 秒。 Resistor shall be clamped in the trough of 90°C metallic V-block and shall be tested at AC potential respectively specified in the given list of each product type for 60~70s. | 无击穿, 飞弧及可见机械性损伤 No evidence of flashover, mechanical damage, arcing or insulation breakdown |
| 温度循环 Temperature cycling | -55 ± 3°C (30 分钟) ~ 室温 (10-15 分钟) ~ 155 ± 2°C (30 分钟) ~ 室温 (10~15 分钟) 1000 个循环, 试验结束 24 小时后进行测试。 -55 ± 3°C 30min ~ normal temperature 10min-15min ~ 155 ± 2°C 30min ~ normal temperature 10min-15min 1000 cycles, Measurement at 24 hours after test conclusion. JESD22 Method JA-104 | ±1%: ±(0.5%+0.1Ω) Max (最大) ±5%: ±(1.0%+0.1Ω) Max (最大) |
| 负载寿命 Load life | 125°C, 额定功率, 试验结束 24 小时后进行测试。 125°C, at rated power, Measurement at 24 ± 2 hours after test conclusion. MIL-STD-202 Method 108 | ±1%: ±(1.0%+0.1Ω) Max (最大) ±5%: ±(3.0%+0.1Ω) Max (最大) |

Ordering Procedure (Example: HQ06 1/4W-S 5% 1.2 Ω T/R-5000)

订购方式 (例如: HQ06 1/4W-S 5% 1.2 Ω T/R-5000)

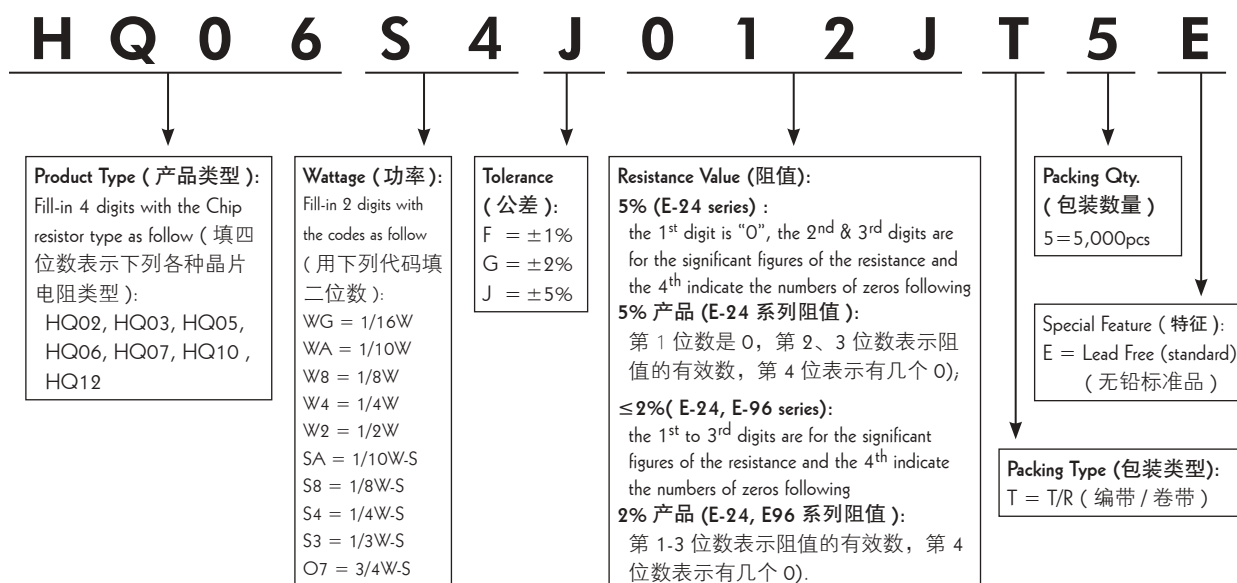

Feature (特性)

- Non-magnetic 无磁性
- Suitable for reflow & wave soldering 适合波峰焊与回流焊
- Application Mobile Phone, PDA, Setbox, Meter 适用于移动电话、PDA、机顶盒、仪表



Figures (型状)

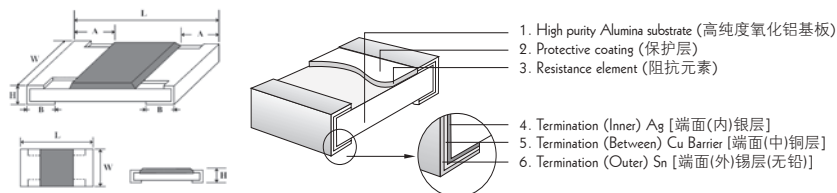

Derating Curve (降功率曲线)

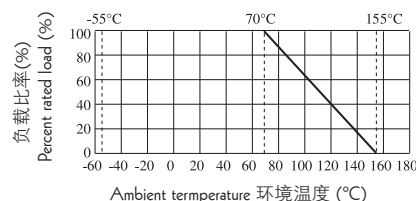

Specification (性能)

| Type 类型 | Max working voltage 最大工作电压 | Max Overload Voltage 最大过负荷电压 | Operating Temperature 工作温度范围 |
|------------|-------------------------------|---------------------------------|---------------------------------|
| NM02 | 50V | 100V | -55~+155°C |
| NM03 | 50V | 100V | |
| NM05 | 150V | 300V | |

| Type 类型 | Power 功率 (70°C) | L (mm) | W (mm) | H (mm) | A (mm) | B (mm) | Resistance Range 阻值范围 1%(E96), 5%(E24) |
|------------|--------------------|-----------|--|-----------|-----------|-----------|--|
| NM02 | 1/16W | 1.00±0.10 | 0.50±0.05 | 0.35±0.05 | 0.20±0.20 | 0.25±0.10 | 1Ω~10M |
| NM03 | 1/16W (1/10W-S) | 1.60±0.10 | 0.80 ^{+0.15} _{-0.10} | 0.45±0.10 | 0.30±0.20 | 0.30±0.20 | |
| NM05 | 1/10W (1/8W-S) | 2.00±0.15 | 1.25 ^{+0.15} _{-0.10} | 0.55±0.10 | 0.40±0.20 | 0.40±0.20 | |

Performance Specification (性能)

| | | |
|---------------------------------|--------|--|
| Temperature coefficient | 温度系数 | 1Ω~10 Ω: ≤±400ppm/°C 11Ω~100 Ω: ≤±200ppm/°C >100Ω: ±100ppm/°C |
| Short-time overload | 短时间过负荷 | ±1%: ±(1.0%+0.1Ω)Max. (最大) ±5%: ±(2.0%+0.1Ω)Max. (最大) |
| Terminal bending | 端子弯曲 | ±(1.0%+0.05Ω)Max. (最大) |
| Solderability | 可焊性 | Min. 95% Coverage (最少 95% 覆盖率) |
| Soldering heat | 耐焊接热 | ±(1.0%+0.05Ω) Max. (最大) |
| Humidity (Stead State) | 恒定湿热 | ±1%: ±(0.5%+0.1Ω)Max. (最大) ±5%: ±(3.0%+0.1Ω) Max. (最大) |
| Dielectric withstanding voltage | 绝缘耐压 | No evidence of flashover, mechanical damage, arcing or insulation breakdown 无击穿, 飞弧及可见机械性损伤 |
| Temperature Cycling | 温度循环 | ±1%: ±(0.5%+0.05Ω) Max.(最大) ±5%: ±(1.0%+0.05Ω) Max.(最大) |
| Load life | 负载寿命 | ±1%: ±(1.0%+0.1Ω) Max.(最大) ±5%: ±(3.0%+0.1Ω) Max.(最大) |

Ordering Procedure (Example: NM02 1/16W 5% 1.2 Ω T/R-10000)

订购方式 (例如: NM02 1/16W 5% 1.2 Ω T/R-10000)

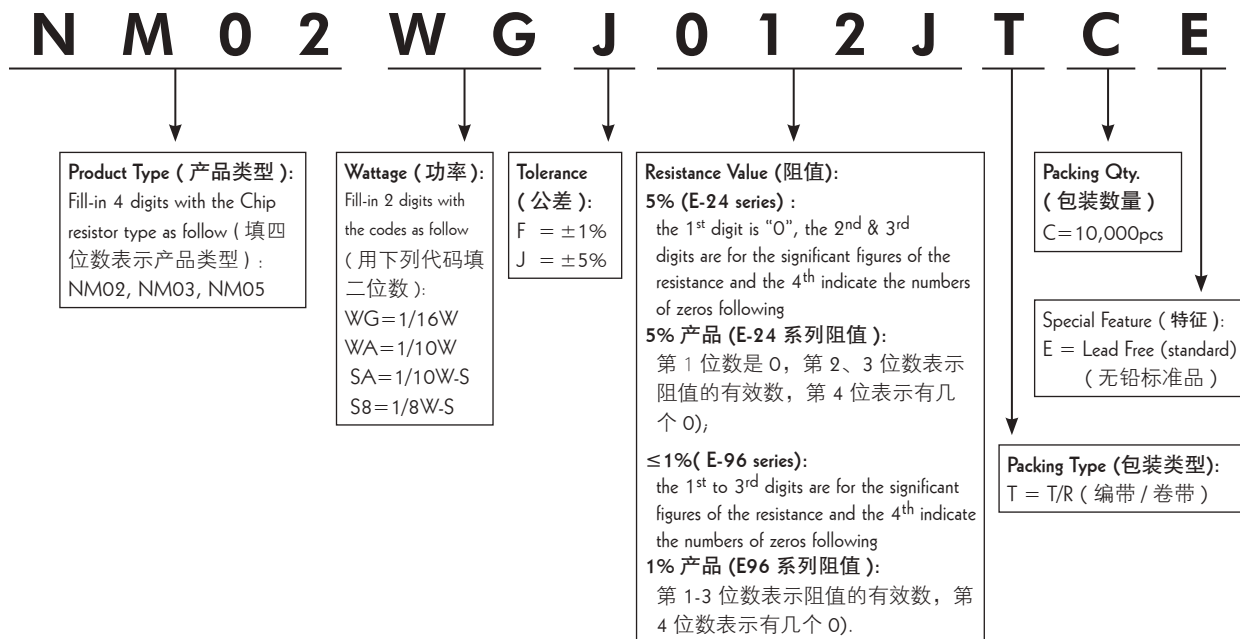

Feature (特性)

- Anti-Sulfidation (抗硫化)
- Suitable for reflow & wave soldering (适合波峰焊与回流焊)
- Application car, power (适用于汽车、电源等)

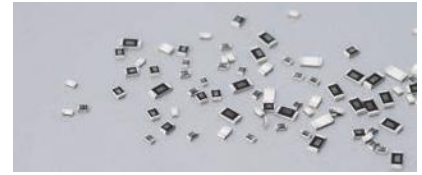

Figures (型状)

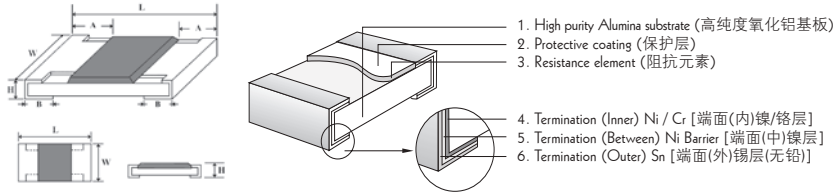

Derating Curve (降功率曲线)

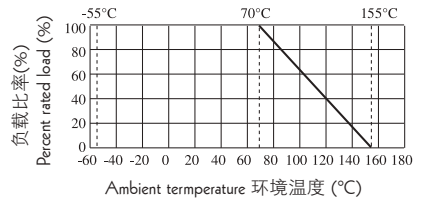

Specification (性能)

| Type 类型 | Max working voltage 最大工作电压 | Max Overload Voltage 最大过负荷电压 | Dielectric Withstanding Voltage 绝缘耐压 | Resistance Value of Jumper 零欧姆电阻阻值 | Rated Current Of Jumper 零欧姆电阻额定电流 | Max. Current Of Jumper 零欧姆电阻最大电流 | Operating Temperature 工作温度范围 |
|---------|----------------------------|------------------------------|--------------------------------------|------------------------------------|-----------------------------------|----------------------------------|------------------------------|
| NS03 | 50V | 100V | 300V | < 50mΩ | 1A | 2A | -55~+155°C |
| NS05 | 150V | 300V | 500V | < 50mΩ | 1A | 5A | |
| NS06 | 200V | 400V | 500V | < 50mΩ | 2A | 10A | |

| Type 类型 | Power 功率 (70°C) | L (mm) | W (mm) | H (mm) | A (mm) | B (mm) | Resistance Range 阻值范围 1%(E96), 5%(E24) |
|---------|-----------------|-----------|--|-----------|-----------|-----------|---|
| NS03 | 1/16W (1/10W-S) | 1.60±0.10 | 0.80 ^{+0.15} _{-0.10} | 0.45±0.10 | 0.30±0.20 | 0.30±0.20 | 1%, 5%: 1Ω~10M 0Ω |
| NS05 | 1/10W (1/8W-S) | 2.00±0.15 | 1.25 ^{+0.15} _{-0.10} | 0.55±0.10 | 0.40±0.20 | 0.40±0.20 | |
| NS06 | 1/8W (1/4W-S) | 3.10±0.15 | 1.55 ^{+0.15} _{-0.10} | 0.55±0.10 | 0.45±0.20 | 0.45±0.20 | |

Performance Specification (性能)

| | |
|--------------------------------------|--|
| Temperature coefficient 温度系数 | 1Ω~10Ω: ≤±400ppm/°C 11Ω~100Ω: ≤±200ppm/°C >100Ω: ±100ppm/°C |
| Short-time overload 短时间过负荷 | ±1%: ±(1.0%+0.1Ω)Max. (最大) ±5%: ±(2.0%+0.1Ω)Max. (最大) |
| Terminal bending 端子弯曲 | ±(1.0%+0.05Ω)Max. (最大) |
| Solderability 可焊性 | Min. 95% Coverage (最少 95% 覆盖率) |
| Soldering heat 耐焊接热 | ±(1.0%+0.05Ω) Max. (最大) |
| Humidity (Stead State) 恒定湿热 | ±1%: ±(0.5%+0.1Ω)Max. (最大) ±5%: ±(3.0%+0.1Ω) Max. (最大) |
| Dielectric withstanding voltage 绝缘耐压 | No evidence of flashover, mechanical damage, arcing or insulation breakdown 无击穿, 飞弧及可见机械性损伤 |
| Temperature Cycling 温度循环 | ±1%: ±(0.5%+0.05Ω) Max. (最大) ±5%: ±(1.0%+0.05Ω) Max. (最大) |
| Load life 负载寿命 | ±1%: ±(1.0%+0.1Ω) Max. (最大) ±5%: ±(3.0%+0.1Ω) Max. (最大) |
| Sulfuration test 耐硫化性 | H2S 1000ppm, 25°C, 90%Rh, 720h ±(0.5%+0.05Ω) Max. (最大) |

Ordering Procedure (Example: NS06 1/8W 5% 1.2 Ω T/R-5000)

订购方式 (例如: NS06 1/8W 5% 1.2 Ω T/R-5000)

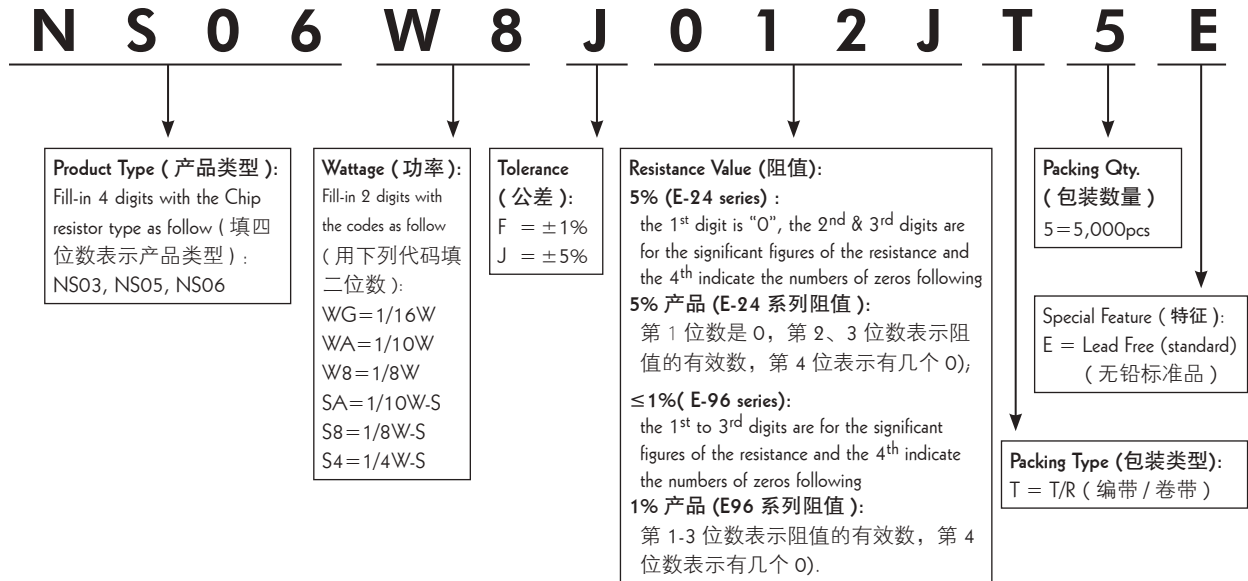

Feature (特性)

- Suitable for reflow & wave soldering (适合波峰焊与回流焊)
- Application Soft Circuit board (适用于软性电路板)

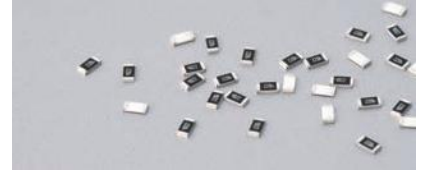

Figures (型状)

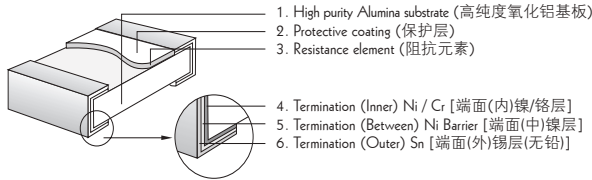
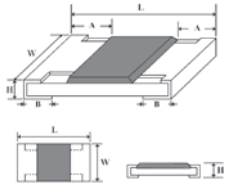

Derating Curve (降功率曲线)

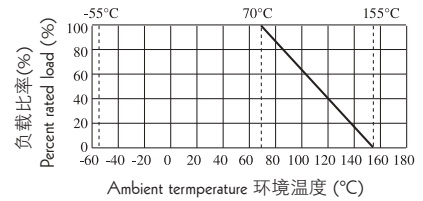

Specification (性能)

| Type 类型 | Max working voltage 最大工作电压 | Max Overload Voltage 最大过负荷电压 | Dielectric Withstanding Voltage 绝缘耐压 | Operating Temperature 工作温度范围 |
|------------|-------------------------------|---------------------------------|---|---------------------------------|
| LE06 | 200V | 400V | 500V | -55~+155°C |

| Type 类型 | Power 功率 (70°C) | L (mm) | W (mm) | H (mm) | A (mm) | B (mm) | Resistance Range 阻值范围 1%(E96), 5%(E24) |
|------------|--------------------|-----------|--|-----------|-----------|-----------|--|
| LE06 | 1/8W (1/4W-S) | 3.10±0.15 | 1.55 ^{+0.15} _{-0.10} | 0.55±0.10 | 0.45±0.20 | 0.45±0.20 | 0.5%, 1%, 2%, 5%: 1Ω~10M 0Ω |

Performance Specification (性能)

| | | |
|---------------------------------|--------|--|
| Temperature coefficient | 温度系数 | 1Ω~10Ω: ≤±400ppm / °C 11Ω~100Ω: ≤±200ppm / °C >100Ω: ±100ppm / °C |
| Short-time overload | 短时间过负荷 | ±5%, ±2%: ±(2.0%+0.1Ω)Max. (最大) ±1%, ±0.5%: ±(1.0%+0.1Ω)Max. (最大) |
| Terminal bending | 端子弯曲 | ±(1.0%+0.05Ω)Max. (最大) |
| Solderability | 可焊性 | Min. 95% Coverage (最少 95% 覆盖率) |
| Soldering heat | 耐焊接热 | ±(1.0%+0.05Ω) Max. (最大) |
| Humidity (Stead State) | 恒定湿热 | ±5%, ±2%: ±(3.0%+0.1Ω)Max. (最大) ±1%, ±0.5%: ±(0.5%+0.1Ω)Max. (最大) |
| Dielectric withstanding voltage | 绝缘耐压 | No evidence of flashover, mechanical damage, arcing or insulation breakdown 无击穿, 飞弧及可见机械性损伤 |
| Temperature Cycling | 温度循环 | ±5%, ±2%: ±(1.0%+0.05Ω)Max. (最大) ±1%, ±0.5%: ±(0.5%+0.05Ω)Max. (最大) |
| Load life | 负载寿命 | ±5%, ±2%: ±(3.0%+0.1Ω)Max. (最大) ±1%, ±0.5%: ±(1.0%+0.1Ω)Max. (最大) |

Ordering Procedure (Example: LE06 1/4W-S 5% 1.2 Ω T/R-5000)

订购方式 (例如: LE06 1/4W-S 5% 1.2 Ω T/R-5000)

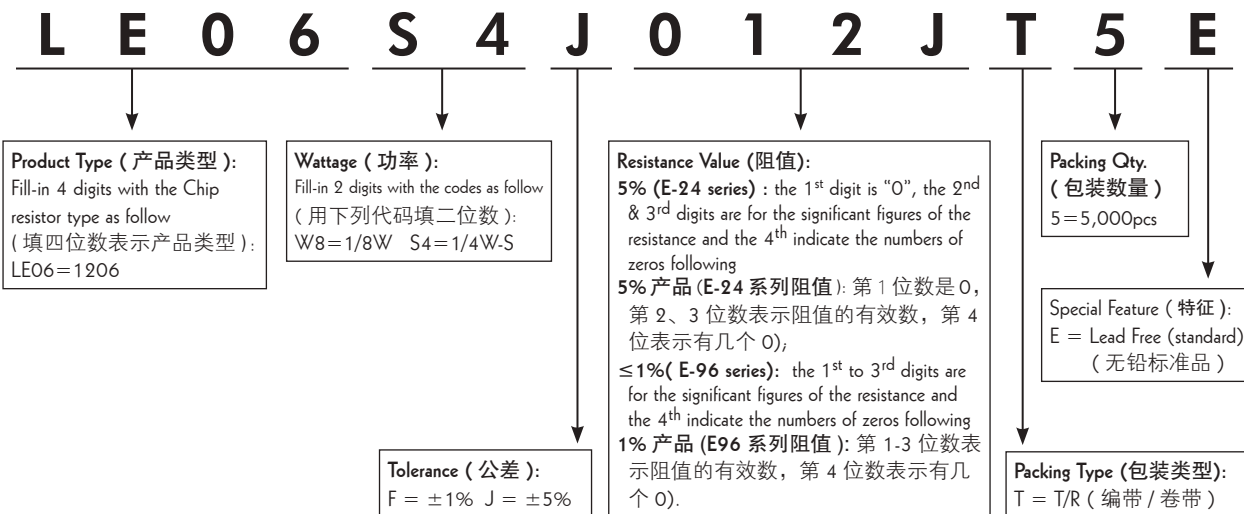

Feature (特性)

- Thin film NiCr Resistance element 薄膜镍铬阻抗元件
- Very tight tolerance from 精密的公差从 $\pm 0.10\%$, $\pm 0.25\%$
- Extremely low TCR from 极低的 TCR从 $\pm 5 \sim \pm 50 \text{ PPM}/^\circ\text{C}$
- Totally Lead-free 完全无铅产品

Application (应用)

- Medical Equipment 医疗器材
- Testing / Measurement Equipment 检测仪器
- Communication Device, Cell Phone, GPS, PDA. 通讯用具, 手机, GPS, PDA
- Automatic equipment controller 自动化设备控制器
- Printer Equipment 打印器材
- Converters 变频器

Figures (型状)



Derating Curve (降功率曲线)

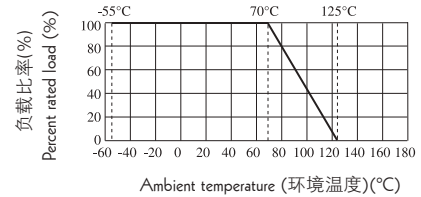

| Type 类型 | L (mm) | W (mm) | H (mm) | A (mm) | B (mm) |
|---------|-----------|--|-----------|-----------|-----------|
| TC02 | 1.00±0.10 | 0.50 ±0.05 | 0.35±0.05 | 0.20±0.10 | 0.25±0.10 |
| TC03 | 1.60±0.10 | 0.80 ^{+0.15} / _{-0.10} | 0.45±0.10 | 0.30±0.20 | 0.30±0.20 |
| TC05 | 2.00±0.15 | 1.25 ^{+0.15} / _{-0.10} | 0.55±0.10 | 0.40±0.20 | 0.40±0.20 |
| TC06 | 3.10±0.15 | 1.55 ^{+0.15} / _{-0.10} | 0.55±0.10 | 0.45±0.20 | 0.45±0.20 |
| TC07 | 3.10±0.10 | 2.60 ^{+0.15} / _{-0.10} | 0.55±0.10 | 0.45±0.20 | 0.45±0.20 |
| TC10 | 5.00±0.10 | 2.50 ^{+0.15} / _{-0.10} | 0.55±0.10 | 0.60±0.25 | 0.50±0.20 |
| TC12 | 6.35±0.10 | 3.20 ^{+0.15} / _{-0.10} | 0.55±0.10 | 0.60±0.25 | 0.50±0.20 |

Ordering Procedure (Example: Thin Film TC06 1/8W 0.1% 25PPM 1KΩ T/R-5000)

订购方式(例如: 薄膜TC06 1/8W 0.1% 25PPM 1KΩ T/R-5000)

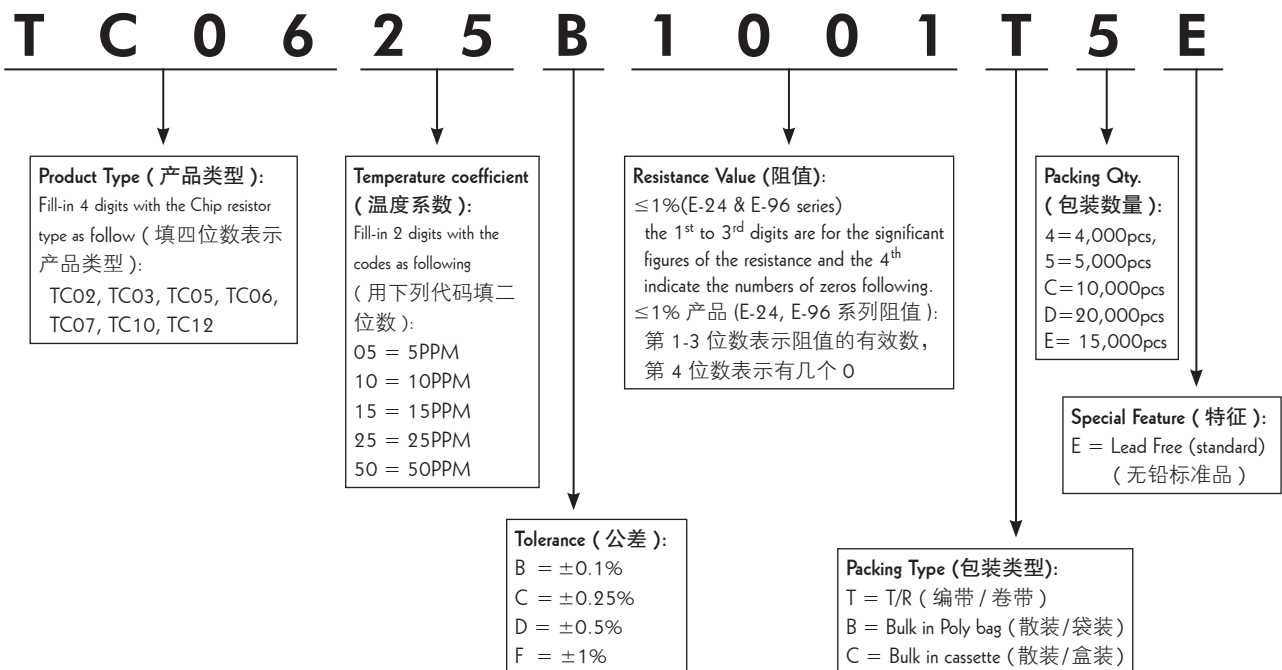

Performance Specification (性能)

| | | |
|-------------------------|--------|---|
| Short-time overload | 短时间过负荷 | $\Delta R \leq \pm 0.5\%$ |
| Insulation Resistance | 绝缘电阻 | $\geq 1000M\Omega$ |
| Load life | 负载寿命 | $\Delta R \leq \pm 0.2\%$ > 7K Ω $\Delta R \leq \pm 0.5\%$ |
| Humidity (Steady State) | 恒定湿热 | $\Delta R \leq \pm 0.3\%$ |
| Terminal bending | 端子弯曲 | $\Delta R \leq \pm 0.2\%$ |
| Solderability | 可焊性 | Min 95% coverage (最少 95% 覆盖率) |
| Soldering heat | 耐焊接热 | $\Delta R \leq \pm 0.2\%$ |

Characteristics (特性)

| Type 类型 | Power Rating 功率 at 70°C | Operating Temperature 工作温度范围 | Max. Working Voltage 最大工作电压 | Max. Overload Voltage 最大过负荷电压 | Resistance Tolerance 阻值公差 | Resistance Range 阻值范围 | TCR 温度系数 (PPM/°C) |
|------------|-------------------------------|------------------------------------|-----------------------------------|-------------------------------------|--|-----------------------------|-------------------------|
| TC02 | 1/16W | -55~+125°C | 25V | 50V | $\pm 0.10\%$ $\pm 0.25\%$ $\pm 0.5\%$ $\pm 1\%$ | 100 Ω ~ 2K Ω | $\pm 5\text{ppm}$ |
| | | | | | | 50 Ω ~ 12K Ω | $\pm 10\text{ppm}$ |
| | | | | | | 10 Ω ~ 332K Ω | $\pm 25\text{ppm}$ |
| | | | | | | 10 Ω ~ 332K Ω | $\pm 50\text{ppm}$ |
| TC03 | 1/16W | -55~+125°C | 50V | 100V | $\pm 0.10\%$ $\pm 0.25\%$ $\pm 0.5\%$ $\pm 1\%$ | 100 Ω ~ 4K Ω | $\pm 5\text{ppm}$ |
| | | | | | | 50 Ω ~ 50K Ω | $\pm 10\text{ppm}$ |
| | | | | | | 10 Ω ~ 1M Ω | $\pm 25\text{ppm}$ |
| | | | | | | 10 Ω ~ 1M Ω | $\pm 50\text{ppm}$ |
| TC05 | 1/10W | -55~+125°C | 100V | 200V | $\pm 0.10\%$ $\pm 0.25\%$ $\pm 0.5\%$ $\pm 1\%$ | 100 Ω ~ 10K Ω | $\pm 5\text{ppm}$ |
| | | | | | | 50 Ω ~ 100K Ω | $\pm 10\text{ppm}$ |
| | | | | | | 4.7 Ω ~ 1M Ω | $\pm 25\text{ppm}$ |
| | | | | | | 4.7 Ω ~ 1M Ω | $\pm 50\text{ppm}$ |
| TC06 | 1/8W | -55~+125°C | 150V | 300V | $\pm 0.10\%$ $\pm 0.25\%$ $\pm 0.5\%$ $\pm 1\%$ | 100 Ω ~ 15K Ω | $\pm 5\text{ppm}$ |
| | | | | | | 50 Ω ~ 200K Ω | $\pm 10\text{ppm}$ |
| | | | | | | 4.7 Ω ~ 1M Ω | $\pm 25\text{ppm}$ |
| | | | | | | 4.7 Ω ~ 1M Ω | $\pm 50\text{ppm}$ |
| TC07 | 1/5W | -55~+125°C | 150V | 300V | $\pm 0.10\%$ $\pm 0.25\%$ $\pm 0.5\%$ $\pm 1\%$ | 100 Ω ~ 25K Ω | $\pm 5\text{ppm}$ |
| | | | | | | 50 Ω ~ 200K Ω | $\pm 10\text{ppm}$ |
| | | | | | | 4.7 Ω ~ 1M Ω | $\pm 25\text{ppm}$ |
| | | | | | | 4.7 Ω ~ 1M Ω | $\pm 50\text{ppm}$ |
| TC10 | 1/4W | -55~+125°C | 150V | 300V | $\pm 0.10\%$ $\pm 0.25\%$ $\pm 0.5\%$ $\pm 1\%$ | 100 Ω ~ 25K Ω | $\pm 5\text{ppm}$ |
| | | | | | | 50 Ω ~ 200K Ω | $\pm 10\text{ppm}$ |
| | | | | | | 4.7 Ω ~ 1M Ω | $\pm 25\text{ppm}$ |
| | | | | | | 4.7 Ω ~ 1M Ω | $\pm 50\text{ppm}$ |
| TC12 | 1/2W | -55~+125°C | 150V | 300V | $\pm 0.10\%$ $\pm 0.25\%$ $\pm 0.5\%$ $\pm 1\%$ | 100 Ω ~ 25K Ω | $\pm 5\text{ppm}$ |
| | | | | | | 50 Ω ~ 200K Ω | $\pm 10\text{ppm}$ |
| | | | | | | 4.7 Ω ~ 1M Ω | $\pm 25\text{ppm}$ |
| | | | | | | 4.7 Ω ~ 1M Ω | $\pm 50\text{ppm}$ |

Feature (特性)

- Thin film Ni/Cr Resistance element 薄膜镍铬阻抗元件
- High power & Low noise 高功率, 低噪声
- Extremely low TCR from (低温度系数) $\pm 25\text{PPM}/^\circ\text{C}$, $\pm 50\text{PPM}/^\circ\text{C}$
- Totally Lead-free 完全无铅产品

Application (应用)

- Control circuit V.C.R V.C.R 控制电路
- Air-conditioner 空调器
- Computer, color TV 电脑, 电视
- Facsimile 传真机



Figures (型状)

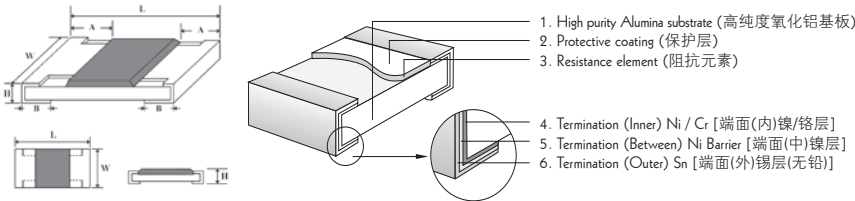

Derating Curve (降功率曲线)

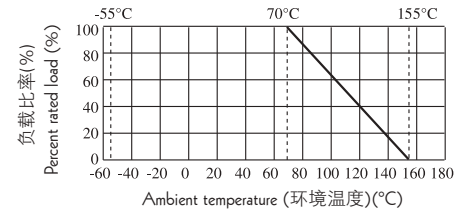

| Type 类型 | L (mm) | W (mm) | H (mm) | A (mm) | B (mm) |
|---------|-----------|--|-----------|-----------|-----------|
| TP03 | 1.60±0.10 | 0.80 ^{+0.15} / _{-0.10} | 0.45±0.10 | 0.30±0.20 | 0.30±0.20 |
| TP05 | 2.00±0.15 | 1.25 ^{+0.15} / _{-0.10} | 0.55±0.10 | 0.40±0.20 | 0.40±0.20 |
| TP06 | 3.10±0.15 | 1.55 ^{+0.15} / _{-0.10} | 0.55±0.10 | 0.45±0.20 | 0.45±0.20 |

Characteristics (特性)

| Type 类型 | Power Rating 功率 at 70°C | Max. Working Voltage 最大工作电压 | Max. Overload Voltage 最大过负荷电压 | Resistance Range 阻值范围 | Tolerance 公差 | Operating Temperature 工作温度范围 | T.C.R 温度系数 (PPM/°C) |
|---------|-------------------------|-----------------------------|-------------------------------|-----------------------|--------------|------------------------------|---------------------|
| TP03 | 1/10W, 1/6W-S | 75V | 150V | 10Ω~1MΩ | ±0.1% | -55°C~+155°C | ±25PPM/°C |
| TP05 | 1/8W, 1/4W-S | 150V | 300V | 10Ω~1MΩ | ±0.25% | | |
| TP06 | 1/4W, 1/3W-S | 200V | 400V | 10Ω~1MΩ | ±0.5% ±1% | | |

Performance Specification (性能)

| | | | |
|----------------------------|---|------------------------------|-------------------------------|
| Short-time overload 短时间过负荷 | $\Delta R \leq \pm 0.5\%$ | Humidity (Steady State) 恒定湿热 | $\Delta R \leq \pm 0.3\%$ |
| Insulation Resistance 绝缘电阻 | $\geq 1,000\text{M}\Omega$ | Terminal bending 端子弯曲 | $\Delta R \leq \pm 0.2\%$ |
| Load life 负载寿命 | $\Delta R \leq \pm 0.2\%$ | Solderability 可焊性 | Min 95% coverage (最少 95% 覆盖率) |
| | $> 7\text{K}\Omega \Delta R \leq \pm 0.5\%$ | Soldering heat 耐焊接热 | $\Delta R \leq \pm 0.2\%$ |

Ordering Procedure (Example: High Power Thin Film TP06 1/4W 0.1% 25PPM 1KΩ T/R-5000)

订购方式 (例如: 高功率薄膜 TP06 1/4W 0.1% 25PPM 1KΩ T/R-5000)

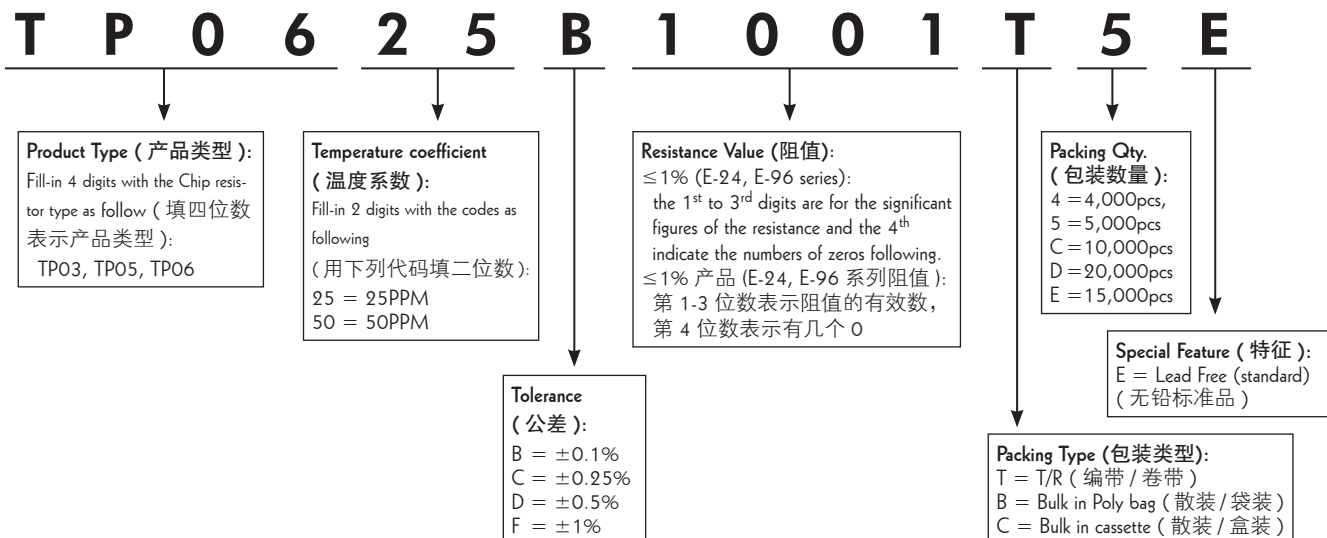

Feature (特性)

- Thin film Ni/Cr Resistance element
薄膜镍铬阻抗元件
- Extremely low TCR from (低温度系数)
±50PPM/°C
- Totally Lead-free 完全无铅产品
- Low noise 低噪声

Application (应用)

- Control circuit V.C.R V.C.R 控制电路
- Air-conditioner 空调器
- Computer, color TV 电脑, 电视
- Facsimile 传真机



Figures (型状)

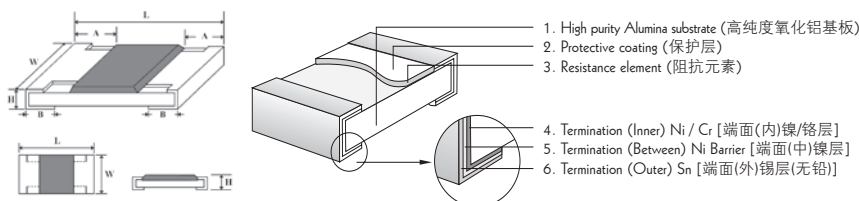

Derating Curve (降功率曲线)

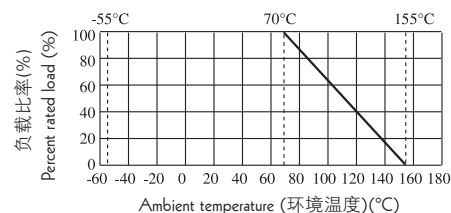

| Type 类型 | L (mm) | W (mm) | H (mm) | A (mm) | B (mm) |
|---------|-----------|---------------------|-----------|-----------|-----------|
| TC02 | 1.00±0.10 | 0.50 ±0.05 | 0.35±0.10 | 0.20±0.10 | 0.25±0.10 |
| TC03 | 1.60±0.10 | 0.80 +0.15 -0.10 | 0.45±0.10 | 0.30±0.20 | 0.30±0.20 |
| TC05 | 2.00±0.15 | 1.25 +0.15 -0.10 | 0.55±0.10 | 0.40±0.20 | 0.40±0.20 |
| TC06 | 3.10±0.15 | 1.55 +0.15 -0.10 | 0.55±0.10 | 0.45±0.20 | 0.45±0.20 |

Characteristics (特性)

| Type 类型 | Power Rating 功率 at 70°C | Max. Working Voltage 最大工作电压 | Max. Overload Voltage 最大过负荷电压 | Resistance Range 阻值范围 | Tolerance 公差 | Operating Temperature 工作温度范围 | T.C.R 温度系数 (PPM/°C) |
|---------|-------------------------|-----------------------------|-------------------------------|-----------------------|--------------|------------------------------|---------------------|
| TC02 | 1/16W | 50V | 100V | 10Ω~10K | ±5% | -55°C~+155°C | ±50PPM/°C |
| TC03 | 1/16W, 1/10W-S | 50V | 100V | | | | |
| TC05 | 1/10W, 1/8W-S | 150V | 300V | | | | |
| TC06 | 1/8W, 1/4W-S | 200V | 400V | | | | |

Performance Specification (性能)

| | | | |
|------------------------------|-----------|-----------------------|-------------------------------|
| Short-time overload 短时间过负荷 | ΔR ≤ ±2% | Terminal bending 端子弯曲 | ΔR ≤ ±1% |
| Insulation Resistance 绝缘电阻 | ≥ 1,000MΩ | Solderability 可焊性 | Min 95% coverage (最少 95% 覆盖率) |
| Load life 负载寿命 | ΔR ≤ ±3% | Soldering heat 耐焊接热 | ΔR ≤ ±1% |
| Humidity (Steady State) 恒定湿热 | ΔR ≤ ±3% | | |

Ordering Procedure (Example: Thin Film TC06 1/8W 5% 50PPM 100Ω T/R-5000)

订购方式 (例如: TC06 1/8W 5% 50PPM 100Ω T/R-5000)

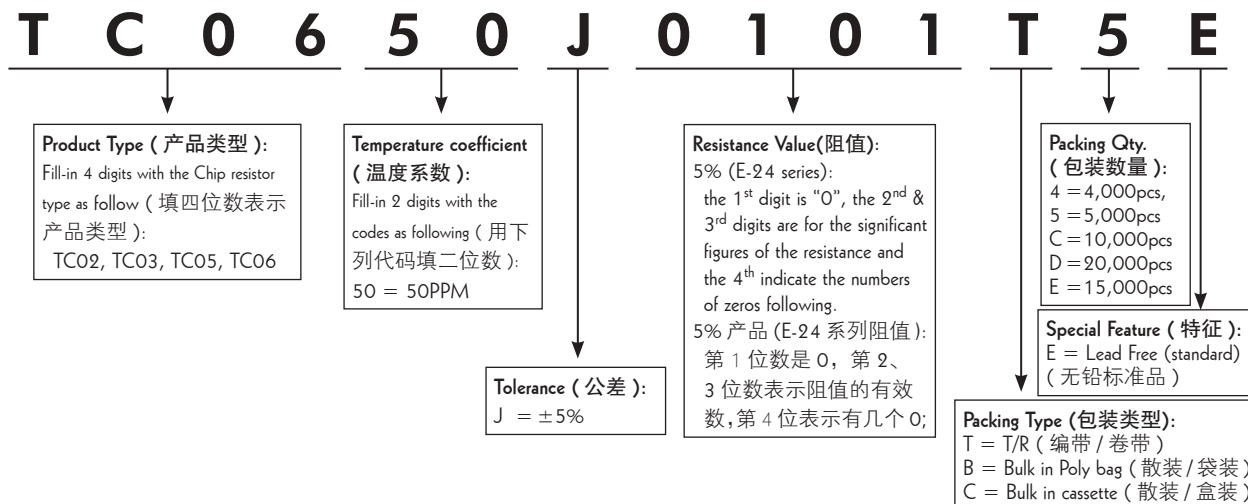

Feature (特性)

- High density, more than 1 resistors in one small case 高度密集, 多个电阻在一个表贴封装中
- Improvement of placement efficiency 装配效率高
- Tape/Reel packaging is suitable for automatic placement machine 编带卷装适合自动化机器
- Superior solderability 优越焊接性
- Application: Master board, CD & DVD Rom, Hard Disk, RAM
应用于 CD、DVD、硬盘、内存、主板等



| | 2D02 | 4D02 | 4D03 | 16P8 |
|---|------|------|------|------|
| Dimension 规格 (mm) | | | | |
| Equivalent Circuit Diagram 等效 电路图 | | | | |

| Type (类型) | 2D02 | 4D02 | 4D03 | 16P8 |
|---|---|---|--|--|
| Rated power (功率) 70°C | 1/16W | 1/16W | 1/16W | 1/16W |
| Max. Working Voltage 最大工作电压 | 50V | 50V | 50V | 50V |
| Max. Overload Voltage 最大过负荷电压 | 100V | 100V | 100V | 100V |
| Dielectric Withstanding Voltage 绝缘耐压 | 100V | 100V | 300V | 300V |
| Resistance Range 阻值范围 | 5% (E-24):10Ω~1MΩ 1% (E-96): 10Ω~1MΩ | 5% (E-24):10Ω~1MΩ 1% (E-96): 10Ω~1MΩ | 5% (E-24): 1Ω~1MΩ 1% (E-96): 1Ω~1MΩ | 5% (E-24): 1Ω~1MΩ 1% (E-96): 1Ω~1MΩ |
| Temperature Coefficient 温度系数 | ±200PPM/°C | ±200PPM/°C | ≥10Ω: ±200PPM/°C <10Ω: ±400PPM/°C | ≥10Ω: ±200PPM/°C <10Ω: ±400PPM/°C |
| Operating Temperature 工作温度范围 | -55°C~+155 °C | -55°C~+155 °C | -55°C~+155 °C | -55°C~+155 °C |
| Resistance Value of Jumper 零欧姆电阻阻值 | <50mΩ | <50mΩ | <50mΩ | <50mΩ |
| Rated Current of Jumper 零欧姆电阻额定电流 | 1A | 1A | 1A | 1A |

Performance Specification (性能)

| | | |
|---------------------------------|--------|--|
| Short-time overload | 短时间过负荷 | ±(2.0% ±0.1Ω) Max.(最大) |
| Insulation resistance | 绝缘电阻 | ≥1,000MΩ |
| Dielectric withstanding voltage | 绝缘耐压 | No evidence of flashover, mechanical damage, arcing or insulation breakdown 无击穿, 飞弧及可见机械性损伤 |
| Terminal bending | 端子弯曲 | ±(1.0% ±0.05Ω) Max.(最大) |
| Soldering heat | 耐焊接热 | ΔR/R ≤ ±(1.0% ±0.05Ω) |
| Solderability | 可焊性 | Min. 95% coverage (最少 95% 覆盖率) |
| Temperature cycling | 温度循环 | ΔR/R ≤ ±(1.0% ±0.05Ω) |
| Load lie in humidity | 湿度寿命 | ±(3.0% ±0.1Ω) Max.(最大) |
| Load life | 负载寿命 | ±(3.0% ±0.1Ω) Max.(最大) |

- Please refer to page 5 for the information of Ordering Procedure (Part No.)
订购方式, 请参考第 5 页 (料号)

Feature (特性)

- High density, more than 1 resistors in one small case 高度密集，多个电阻在一个表贴封装中
- The Concave design in terminal enlarge the Soldering plate area 内凹设计，扩大端头锡焊面积
- The Concave design to reduce the terminal breaking risk 内凹设计，防止端头断裂
- Improvement of placement efficiency 装配效率高
- Application: RAM, CD & DVD Rom, Hard Disk, Master board
应用于CD、DVD、硬盘、内存、主板等

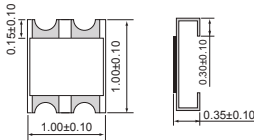
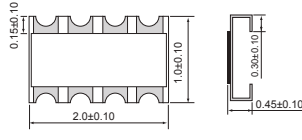
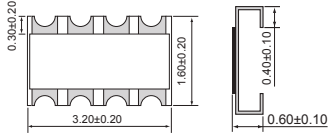
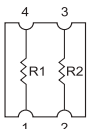
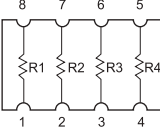
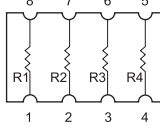

| | 2C02 | 4C02 | 4C03 |
|---|--|--|--|
| Dimension 规格 (mm) |  |  |  |
| Equivalent Circuit Diagram 等效 电路图 |  R1=R2 |  R1=R2=R3=R4 |  R1=R2=R3=R4 |

| Type (类型) | 2C02 | 4C02 | 4C03 |
|---|--|--|--------------------------------------|
| Rated power (功率) 70°C | 1/16W | 1/16W | 1/16W |
| Max. Working Voltage 最大工作电压 | 50V | 50V | 50V |
| Max. Overload Voltage 最大过负荷电压 | 100V | 100V | 100V |
| Dielectric Withstanding Voltage 绝缘耐压 | 100V | 100V | 300V |
| Resistance Range 阻值范围 | 5% (E-24): 10Ω~1MΩ 1% (E-96): 10Ω~1MΩ | 5% (E-24): 10Ω~1MΩ 1% (E-96): 10Ω~1MΩ | 5%, 1%: 1Ω~1M |
| Temperature Coefficient 温度系数 | ±200PPM/°C | ±200PPM/°C | ≥10Ω: ±200PPM/°C <10Ω: ±400PPM/°C |
| Operating Temperature 工作温度范围 | -55°C~+155°C | -55°C~+155 °C | -55°C~+155 °C |
| Resistance Value of Jumper 零欧姆电阻阻值 | <50mΩ | <50mΩ | <50mΩ |
| Rated Current of Jumper 零欧姆电阻额定电流 | 1A | 1A | 1A |

Performance Specification (性能)

| | | |
|---------------------------------|--------|---|
| Short-time overload | 短时间过负荷 | ±(2.0% ±0.1Ω) Max.(最大) |
| Insulation resistance | 绝缘电阻 | ≥1,000MΩ |
| Dielectric withstanding voltage | 绝缘耐压 | No evidence of falshover, mechanical damage, arcing or insulation breakdown 无击穿，飞弧及可见机械性损伤 |
| Terminal bending | 端子弯曲 | ±(1.0% ±0.05Ω) Max. (最大) |
| Soldering heat | 耐焊接热 | ΔR/R ≤ ±(1.0% ±0.05Ω) |
| Solderability | 可焊性 | Min. 95% coverage (最少 95% 覆盖率) |
| Temperature cycling | 温度循环 | ΔR/R ≤ ±(1.0% ±0.05Ω) |
| Load life in humidity | 湿度寿命 | ±(3.0% ±0.1Ω) Max.(最大) |
| Load life | 负载寿命 | ±(3.0% ±0.1Ω) Max.(最大) |

- Please refer to page 5 for the information of Ordering Procedure (Part No.)
订购方式，请参考第5页(料号)

Feature (特性)

- High density, more than 1 resistors in one small case 高度密集, 多个电阻在一个表贴封装中
- Improvement of placement efficiency 装配效率高
- Tape/Reel packaging is suitable for automatic placement machine 编带卷装适合自动化机器
- Superior solderability 优越焊锡性



Dimension (尺寸) (mm)

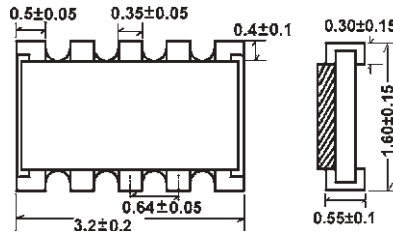

Equivalent Circuit Diagram (等效电路图)

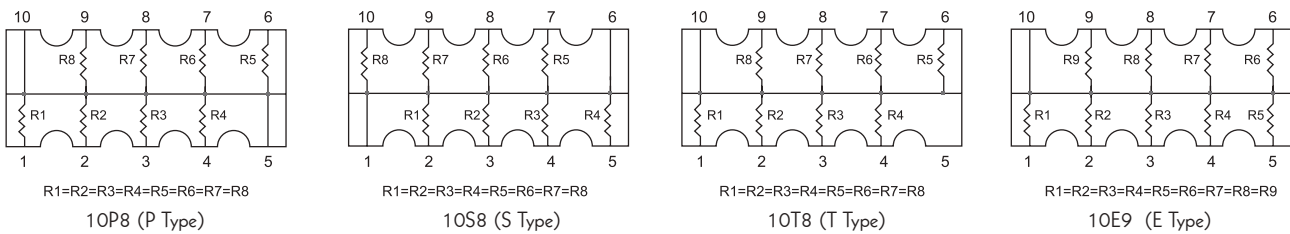

Performance Specification (性能)

| | | |
|---------------------------------|-----------|--|
| Rated Power at 70°C | 功率 | 1/32W [1/16W special provide (可特别提供)] |
| Max. Working Voltage | 最大工作电压 | 25V |
| Max. Overload Voltage | 最大过负荷电压 | 50V |
| Dielectric withstanding Voltage | 绝缘耐压 | 50V |
| Operating temperature | 工作温度 | -55°C ~ +155 °C |
| Resistance Range | 阻值范围 | 5%(E-24 series) & 1%(E-24,E-96 series): 10Ω~1MΩ 5%(E-24 系列) & 1%(E-24,E-96 系列): 10Ω~1MΩ |
| Resistance Value of Jumper | 零欧姆电阻阻值 | < 50mΩ |
| Rated Current of Jumper | 零欧姆电阻额定电流 | 0.5A |
| Temperature Coefficient | 温度系数 | ±200PPM/°C |
| Short-time overload | 短时间过负荷 | ±(2.0% ±0.05Ω) Max.(最大) |
| Insulation resistance | 绝缘电阻 | ≥ 1,000MΩ |
| Dielectric withstanding voltage | 绝缘耐压 | No evidence of flashover, mechanical damage, arcing or insulation breakdown 无击穿, 飞弧及可见机械性损伤 |
| Terminal bending | 端子弯曲 | ±(1.0% ±0.05Ω) Max.(最大) |
| Soldering heat | 耐焊接热 | ΔR/R ≤ ±(1.0% ±0.05Ω) |
| Solderability | 可焊性 | Min.95% coverage (最少 95% 覆盖率) |
| Load life in humidity | 湿度寿命 | ±(3.0% ±0.1Ω) Max.(最大) |
| Load life | 负载寿命 | ±(3.0% ±0.1Ω) Max.(最大) |

• Please refer to page 5 for the information of Ordering Procedure (Part No.)
订购方式, 请参考第 5 页 (料号)

Dimension of Paper Taping (纸带尺寸)(mm)



01005 0201 0402 HP02 HQ02 NM02 TC02 2C02 4C02 4D02 2D02

0603 0805 1206 1210 2010 0508 0612 1020 HQ03 HQ05 HQ06 HQ07 HQ10 HP03 HP05 HP06 HP07 HP10 HV03 HV05 HV06 HV07 HV10 NM03 NM05 NS03 NS05 NS06 AS03 AS05 AS06 PS05 PS06 PS07 CS03 CS05 CS06 CS07 CS10 TC03 TC05 TC06 TC07 TR05 TR06 TP03 TP05 TP06 4D03 4C03 10P8 10S8 10T8 10E9 16P8

| Type (类型) | A±0.2 | B±0.2 | C±0.05 | Ø D $^{+0.1}_0$ | E±0.1 | F±0.05 | G±0.1 | W±0.2 | T±0.1 |
|--|-----------|-----------|--------|-----------------|-------|--------|-------|-------|-------|
| 01005 | 0.24±0.05 | 0.45±0.05 | 2.0 | 1.5 | 1.75 | 3.5 | 4.0 | 8.0 | 0.40 |
| 0201 | 0.40±0.05 | 0.70±0.05 | 2.0 | 1.5 | 1.75 | 3.5 | 4.0 | 8.0 | 0.42 |
| 0402, HP02, HQ02, NM02, TC02 | 0.65 | 1.15 | 2.0 | 1.5 | 1.75 | 3.5 | 4.0 | 8.0 | 0.45 |
| 0603, AS03, CS03, HP03, HQ03, HV03, NM03, NS03, TC03, TP03 | 1.10 | 1.90 | 2.0 | 1.5 | 1.75 | 3.5 | 4.0 | 8.0 | 0.67 |
| 0508, 0805, AS05, CS05, HP05, HQ05, HV05, NM05, NS05, PS05, TC05, TR05, TP05 | 1.65 | 2.40 | 2.0 | 1.5 | 1.75 | 3.5 | 4.0 | 8.0 | 0.81 |
| 0612, 1206, AS06, CS06, HP06, HQ06, HV06, NS06, PS06, TC06, TR06, TP06 | 2.00 | 3.60 | 2.0 | 1.5 | 1.75 | 3.5 | 4.0 | 8.0 | 0.81 |
| 1210, CS07, HP07, HQ07, HV07, PS07, TC07 | 2.80 | 3.50 | 2.0 | 1.5 | 1.75 | 3.5 | 4.0 | 8.0 | 0.75 |
| 2010, HP10, HQ10, HV10, 1020, CS10 | 2.80 | 5.40 | 2.0 | 1.5 | 1.75 | 5.5 | 4.0 | 12.0 | 0.75 |
| 2D02, 2C02 | 1.20 | 1.20 | 2.0 | 1.5 | 1.75 | 3.5 | 4.0 | 8.0 | 0.45 |
| 4D02, 4C02 | 1.20 | 2.20 | 2.0 | 1.5 | 1.75 | 3.5 | 4.0 | 8.0 | 0.70 |
| 4D03, 4C03 | 2.00 | 3.60 | 2.0 | 1.5 | 1.75 | 3.5 | 4.0 | 8.0 | 0.83 |
| 10P8, 10S8, 10T8, 10E9 | 2.00 | 3.60 | 2.0 | 1.5 | 1.75 | 3.5 | 4.0 | 8.0 | 0.85 |
| 16P8 | 1.80 | 4.30 | 2.0 | 1.5 | 1.75 | 5.5 | 4.0 | 12.0 | 0.75 |

Dimension of Embossed Taping (塑胶带尺寸)(mm)

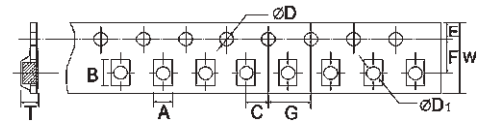

| Type (类型) | A±0.2 | B±0.2 | C±0.05 | Ø D $^{+0.1}_0$ | Ø D ₁ $^{+0.25}_0$ | E±0.1 | F±0.05 | G±0.1 | W±0.2 | T±0.1 |
|--|-------|-------|--------|-----------------|-------------------------------|-------|--------|-------|-------|-------|
| TC10 | 2.9 | 5.6 | 2.0 | 1.5 | 1.5 | 1.75 | 5.5 | 4.0 | 12 | 1.0 |
| 1218, 1812 | 3.5 | 4.8 | 2.0 | 1.5 | 1.5 | 1.75 | 5.5 | 4.0 | 12 | 1.0 |
| 1225, 2512, CS12, HP12, HV12, TC12, HQ12 | 3.5 | 6.7 | 2.0 | 1.5 | 1.5 | 1.75 | 5.5 | 4.0 | 12 | 1.0 |

Dimension of Reel (卷轴尺寸)(mm)

| Type (类型) | Tape 纸带 | Qty. / Reel 数量 / 卷装 | Tape Width 纸带宽 | W ± 1 |
|--|--------------|---------------------|----------------|-------|
| 01005 | Paper 纸带 | 20,000pcs | 8mm | 10 |
| 0201, 0402*, HP02, HQ02, NM02, TC02 | Paper 纸带 | 10,000pcs* | 8mm | 10 |
| 0603, AS03, CS03, HP03, HQ03, HV03, NM03, NS03, TC03, TP03 | Paper 纸带 | 5,000pcs | 8mm | 10 |
| 0508, 0805, AS05, CS05, HP05, HQ05, HV05, NM05, NS05, PS05, TC05, TR05, TP05 | Paper 纸带 | 5,000pcs | 8mm | 10 |
| 0612, 1206, AS06, CS06, HP06, HQ06, HV06, NS06, PS06, TC06, TR06, TP06 | Paper 纸带 | 5,000pcs | 8mm | 10 |
| 1210, CS07, HP07, HQ07, HV07, PS07, TC07 | Paper 纸带 | 5,000pcs | 8mm | 10 |
| 1020, 2010, CS10, HP10, HQ10, HV10 | Paper 纸带 | 5,000pcs | 8mm | 10 |
| 1218, 1812, TC10 | Embossed 塑胶带 | 4,000pcs | 12mm | 13.8 |
| 1225, 2512, CS12, HP12, HV12, TC12, HQ12 | Embossed 塑胶带 | 4,000pcs | 12mm | 13.8 |
| 2D02, 2C02 | Paper 纸带 | 10,000pcs | 8mm | 10 |
| 4D02, 4C02 | Paper 纸带 | 10,000pcs | 8mm | 10 |
| 4D03, 4C03 | Paper 纸带 | 5,000pcs | 8mm | 10 |
| 10P8, 10S8, 10T8, 10E9 | Paper 纸带 | 5,000pcs | 8mm | 10 |
| 16P8 | Paper 纸带 | 4,000pcs | 12mm | 13.8 |

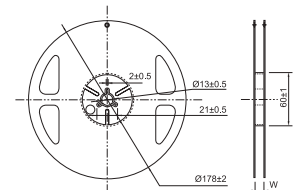

*Remark: 15,000 pcs/reel package could be offered for 0402 size. (备注: 0402 可提供 15,000 只包装)

Dimension of Bulk Cassette (散装箱尺寸) (mm)

36(H)×12(W)×110(L)

Bulk Cassette packing available on a case to case basis (散装可特别提供)



Feature (特性)

- Miniature, high density packaging
小型高密度封装
- High reliability $R_{10}O_2$ paste
使用高稳定性 $R_{10}O_2$ 电阻材料

Application (应用)

- Control circuit V.C.R. (V.C.R.控制电路)
- Air-conditioner (空调)
- Computer, color TV (计算机, 彩电)
- Facsimile (传真机)



Dimension (尺寸) (mm)

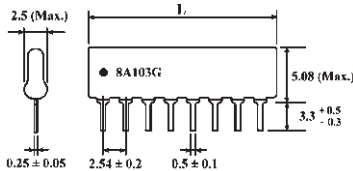

"•" indicate the 1st pin (表示第一脚位置)

Dimension of L (Max.) (L的最大尺寸)

| | |
|----------------|-----------------|
| 4 PIN : 10.2mm | 10 PIN : 25.4mm |
| 5 PIN : 12.7mm | 11 PIN : 28.0mm |
| 6 PIN : 15.3mm | 12 PIN : 30.5mm |
| 7 PIN : 17.8mm | 13 PIN : 33.1mm |
| 8 PIN : 20.4mm | 14 PIN : 35.6mm |
| 9 PIN : 22.9mm | |

Derating Curve (降功率曲线)

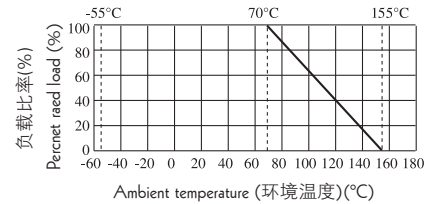

Circuit Structure (电路结构)



* Custom Design Circuit could be available on a case to case basis. (可按客户特殊要求定制)

| Power Rating (功率) 70°C | Max. Working Voltage 最大工作电压 | Max. Overload Voltage 最大过负荷电压 | Dielectric Withstanding Voltage 绝缘耐压 | Resistance Range 阻值范围 | Tolerance 公差 | Operating Temperature 工作温度范围 |
|--|--------------------------------|----------------------------------|---|--|-----------------|---------------------------------|
| B type (B型): 0.2W Others (其它类型): 0.125W | 100V | 150V | 200V | R Type (R型): 100Ω~10KΩ Others (其它类型): 10Ω~1MΩ | ±2% ±5% | -55°C~+155°C |

Marking (Single Value) [标示: (单个阻值)]:

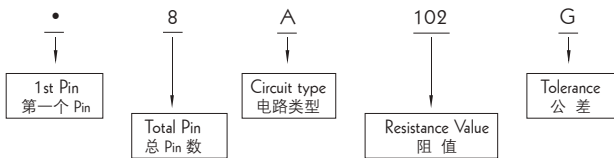

Marking (Dual Value) [标示: (双阻类型)]:

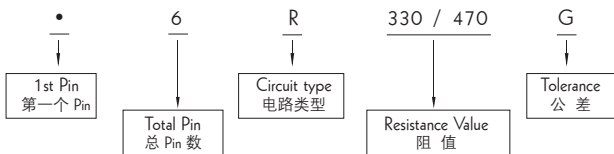

Dual Value (双阻型阻值系列) (R1/R2) (Ohm)

| | |
|-----------|-------------|
| 160 / 240 | 330 / 390 |
| 180 / 390 | 330 / 470 |
| 220 / 270 | 1.5K / 3.5K |
| 220 / 330 | 3.0K / 6.2K |

* Special Value available on a case to case basis. (另可按客户特殊要求订做)

Performance Specifications (性能)

| | |
|---|--|
| Temperature coefficient 温度系数 | 50Ω ~ 1MΩ: ±200PPM/°C < 50Ω & > 1MΩ: ±250PPM/°C |
| Short-time overload 短时间过负荷 | $\Delta R/R \leq \pm(0.5\% + 0.1\Omega)$ |
| Insulation resistance 绝缘电阻 | $\geq 10,000M\Omega$ |
| Dielectric withstanding voltage 绝缘耐压 | No Evidence of flashover, arcing or insulation breakdown (无击穿、飞弧及可见机械损伤) |
| Terminal strength 端子强度 | $\Delta R/R \leq \pm(0.5\% + 0.1\Omega)$ |
| Soldering heat 耐焊接热 | $\Delta R/R \leq \pm(0.5\% + 0.1\Omega)$ |
| Solderability 可焊性 | Min. 95% coverage (最少 95% 覆盖率) |
| Thermal shock 热冲击 | $\Delta R/R \leq \pm(0.5\% + 0.1\Omega)$ |
| Temperature cycling 温度循环 | $\Delta R/R \leq \pm(0.5\% + 0.1\Omega)$ |
| Load life in humidity 湿度寿命 | $\Delta R/R \leq \pm(3\% + 0.1\Omega)$ |
| Load life 负载寿命 | $\Delta R/R \leq \pm(3\% + 0.1\Omega)$ |

Standard Packing of Resistor Network (网络电阻器的标准包装)

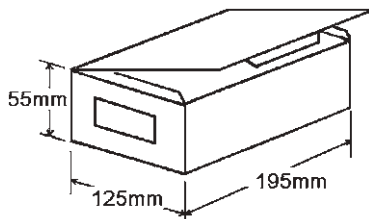

| Pins Pins 数 | Weight of 1,000pcs 1,000 只重量 | Qty. per Bag 每袋数量 | Qty. per Box 每盒数量 | Qty. per Carton 每箱数量 |
|----------------|---------------------------------|----------------------|----------------------|-------------------------|
| 4 | 210g | 500 | 5,000 | 75,000 |
| 5 | 250g | 400 | 4,000 | 60,000 |
| 6 | 320g | 300 | 3,000 | 45,000 |
| 7 | 360g | 200 | 2,000 | 30,000 |
| 8 | 430g | 200 | 2,000 | 30,000 |
| 9 | 450g | 200 | 2,000 | 30,000 |
| 10 | 530g | 150 | 1,500 | 22,500 |
| 11 | 600g | 100 | 1,000 | 15,000 |
| 12 | 650g | 100 | 1,000 | 15,000 |
| 13 | 710g | 100 | 1,000 | 15,000 |
| 14 | 770g | 100 | 1,000 | 15,000 |

Ordering Procedure (Example: RNL A type 10 PIN 2% 10KΩ B/B)

订购方式 (例如: RNL A 型 10 PIN 2% 10KΩ B/B)

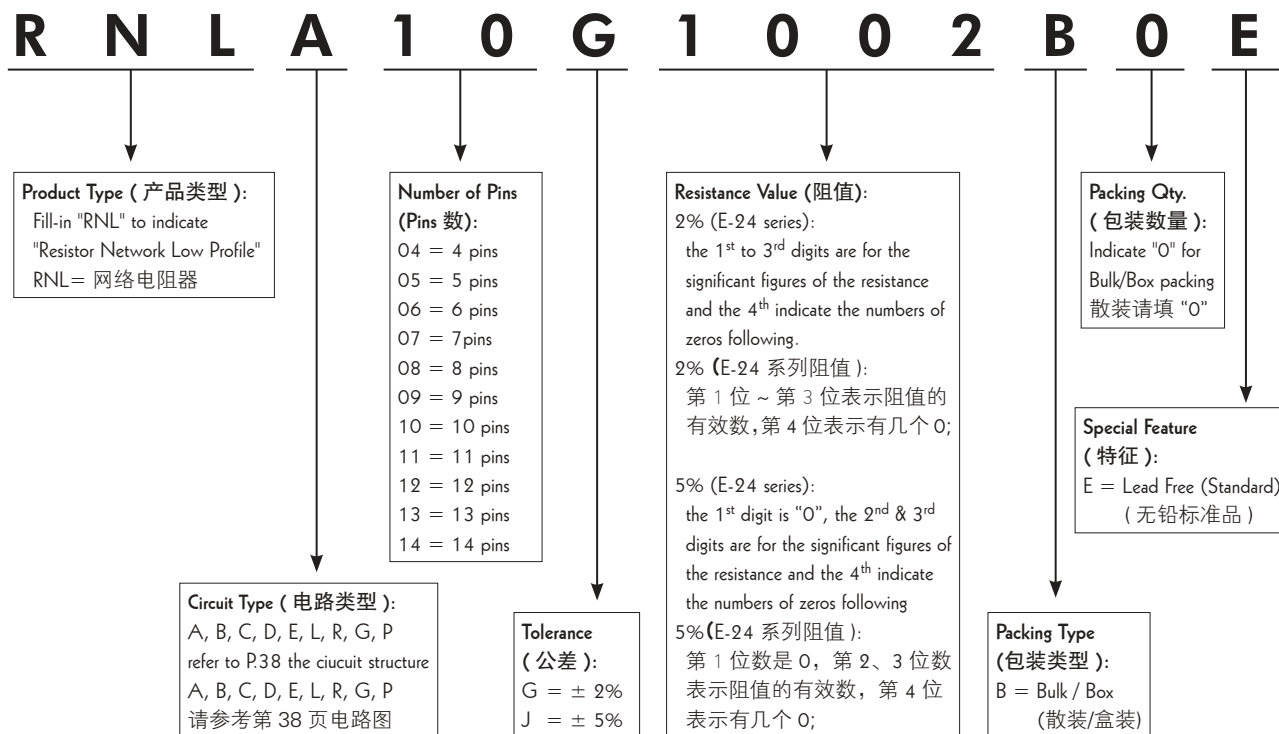

Feature (特性)

- Miniature, high density packaging
小型高密度封装
- High reliability $R_{10}O_2$ paste
使用高稳定性 $R_{10}O_2$ 电阻材料

Application (应用)

- Control circuit V.C.R. (V.C.R.控制电路)
- Air-conditioner (空调)
- Computer, color TV (计算机, 彩电)
- Facsimile (传真机)

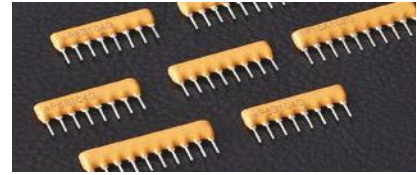

Dimension (尺寸) (mm)

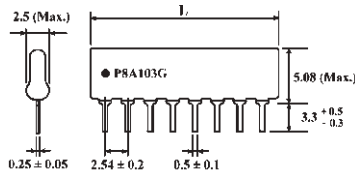

"•" indicate the 1st pin (表示第一脚位置)

Dimension of L (Max.) (L的最大尺寸)

| | |
|----------------|-----------------|
| 4 PIN : 10.2mm | 10 PIN : 25.4mm |
| 5 PIN : 12.7mm | 11 PIN : 28.0mm |
| 6 PIN : 15.3mm | 12 PIN : 30.5mm |
| 7 PIN : 17.8mm | 13 PIN : 33.1mm |
| 8 PIN : 20.4mm | 14 PIN : 35.6mm |
| 9 PIN : 22.9mm | |

Derating Curve (降功率曲线)

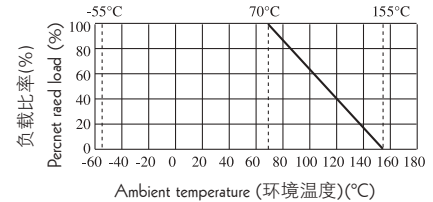

Circuit Structure (电路结构)

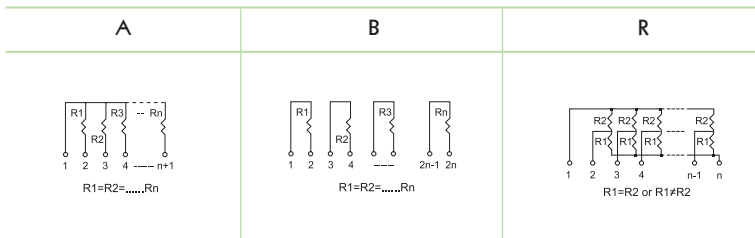

Package Power Ratings (包装功率等级)(Watts)

| Pkg. | Package Power Rating 包装功率等级 | Pkg. | Package Power Rating 包装功率等级 |
|------|--------------------------------|------|--------------------------------|
| 4 | 0.5W | 10 | 1.25W |
| 5 | 0.63W | 11 | 1.38W |
| 6 | 0.75W | 12 | 1.5W |
| 7 | 0.88W | 13 | 1.63W |
| 8 | 1.0W | 14 | 1.75W |
| 9 | 1.13W | | |

* Custom Design Circuit could be available on a case to case basis. (可按客户特殊要求定制)

| Power Rating (功率) 70°C | Max. Working Voltage 最大工作电压 | Max. Overload Voltage 最大过负荷电压 | Dielectric Withstanding Voltage 绝缘耐压 | Resistance Range 阻值范围 | Tolerance 公差 | Operating Temperature 工作温度范围 |
|---------------------------|--------------------------------|----------------------------------|---|--------------------------|-----------------|---------------------------------|
| A: 0.2W | | | | 10Ω ~ 1MΩ | ±2% | |
| B: 0.3W | 100V | 150V | 200V | 10Ω ~ 1MΩ | ±5% | -55°C ~ +155°C |
| R: 0.2W | | | | 100Ω ~ 10KΩ | | |

Marking (Single Value) [标示: (单个阻值)]:

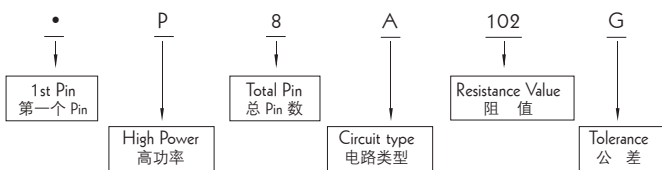

Marking (Dual Value) [标示: (双阻类型)]:



Dual Value(双阻型阻值系列) (R1/R2) (Ohm)

| | |
|-----------|-------------|
| 160 / 240 | 330 / 390 |
| 180 / 390 | 330 / 470 |
| 220 / 270 | 1.5K / 3.5K |
| 220 / 330 | 3.0K / 6.2K |

* Special Value available on a case to case basis. (另可按客户特殊要求订做)

Performance Specifications (性能)

| | |
|---|--|
| Temperature coefficient 温度系数 | 50Ω-1MΩ: ±100PPM/°C <50Ω & >1MΩ: ±250PPM/°C |
| Short-time overload 短时间过负荷 | $\Delta R/R \leq \pm(0.25\% + 0.1\Omega)$ |
| Insulation resistance 绝缘电阻 | $\geq 10,000M\Omega$ |
| Dielectric withstanding voltage 绝缘耐压 | No Evidence of flashover, arcing or insulation breakdown (无击穿、飞弧及可见机械损伤) |
| Terminal strength 端子强度 | $\Delta R/R \leq \pm(0.25\% + 0.1\Omega)$ |
| Soldering heat 耐焊接热 | $\Delta R/R \leq \pm(0.5\% + 0.1\Omega)$ |
| Solderability 可焊性 | Min. 95% coverage (最少 95% 覆盖率) |
| Thermal shock 热冲击 | $\Delta R/R \leq \pm(0.25\% + 0.1\Omega)$ |
| Temperature cycling 温度循环 | $\Delta R/R \leq \pm(0.5\% + 0.1\Omega)_{max}$ (最大) |
| Load life in humidity 湿度寿命 | $\Delta R/R \leq \pm(0.5\% + 0.1\Omega)$ |
| Load life 负载寿命 | $\Delta R/R \leq \pm(1\% + 0.1\Omega)$ |

Standard Packing of Resistor Network (网络电阻器的标准包装)

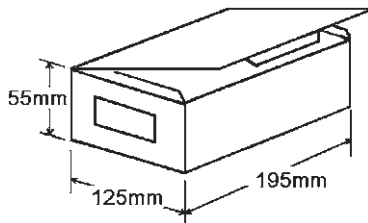

| Pins Pins 数 | Weight of 1,000pcs 1,000 只重量 | Qty. per Bag 每袋数量 | Qty. per Box 每盒数量 | Qty. per Carton 每箱数量 |
|----------------|---------------------------------|----------------------|----------------------|-------------------------|
| 4 | 210g | 500 | 5,000 | 75,000 |
| 5 | 250g | 400 | 4,000 | 60,000 |
| 6 | 320g | 300 | 3,000 | 45,000 |
| 7 | 360g | 200 | 2,000 | 30,000 |
| 8 | 430g | 200 | 2,000 | 30,000 |
| 9 | 450g | 200 | 2,000 | 30,000 |
| 10 | 530g | 150 | 1,500 | 22,500 |
| 11 | 600g | 100 | 1,000 | 15,000 |
| 12 | 650g | 100 | 1,000 | 15,000 |
| 13 | 710g | 100 | 1,000 | 15,000 |
| 14 | 770g | 100 | 1,000 | 15,000 |

Ammo Pack of Resistor Network (网络电阻器编带包装)

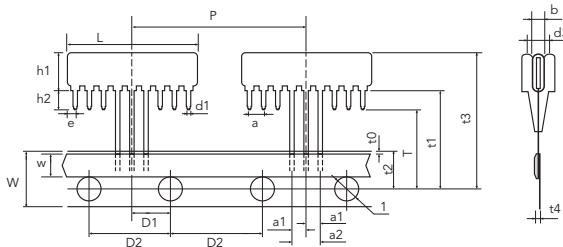

* ... n=Pin Count

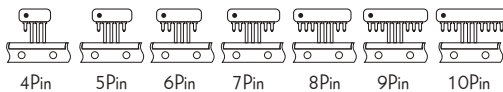

| Dimension 尺寸 (mm) | | Dimension 尺寸 (mm) | |
|-------------------|-------------|-------------------|-----------|
| h1 | Max 5.08 | t 0 | 2.0max |
| L | Max 2.54 *n | t 1 | 18.99±0.5 |
| a | 2.54±0.25 | t 2 | 9.0±0.5 |
| d1 | 0.5±0.1 | t 3 | 24.46 Max |
| P | 25.4±1.0 | t 4 | 1.5max |
| W | 18±0.5 | l | ∅4.0±0.3 |
| w | 5.0min | h2 | 3.0±0.5 |
| P1 | 6.35±0.7 | a1 | 2.54±0.25 |
| P2 | 12.7±0.3 | a2 | 5.08±0.3 |
| b | Max2.49 | d3 | 2.0 Max |
| T | 16±0.5 | / | / |

Packing quantity (包装数量)



The inside box sizes 内盒尺寸:

4~9pin: 320(L) × 207(W) × 40(H)mm

10pin: 315(L) × 295(W) × 40(H)mm

| Pins Pins 数 | Qty. per Box 每盒数量 | Qty. per Carton 每箱数量 |
|----------------|----------------------|-------------------------|
| 4~10 | 1,000 | 12,000 |

Ordering Procedure (Example: RPL A type 10 PIN 2% 10KΩ B/B)

订购方式 (例如: RPL A 型 10 PIN 2% 10KΩ B/B)

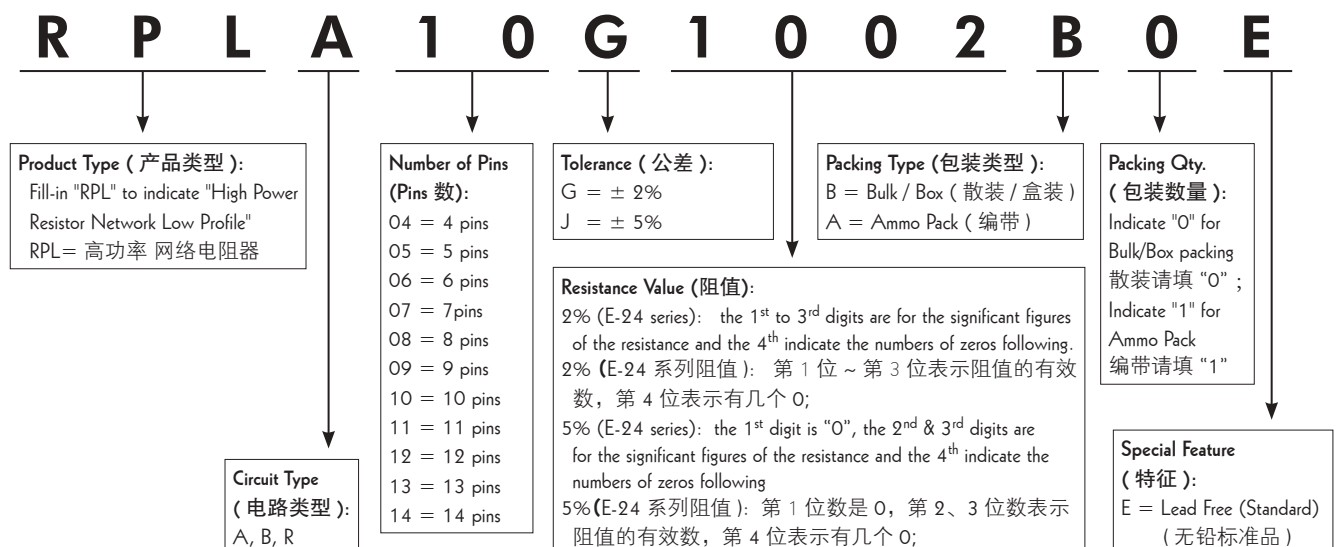

Feature (特性)

- Miniature, high density packaging
小型高密度封装
- High reliability $R_{10}O_2$ paste
使用高稳定性 $R_{10}O_2$ 电阻材料

Application (应用)

- Control circuit V.C.R. (V.C.R.控制电路)
- Air-conditioner (空调)
- Computer, color TV (计算机, 彩电)
- Facsimile (传真机)



Dimension (尺寸) (mm)



"•" indicate the 1st pin (表示第一脚位置)

Dimension of L (Max.) (L的最大尺寸)

| | |
|----------------|-----------------|
| 4 PIN : 10.2mm | 10 PIN : 25.4mm |
| 5 PIN : 12.7mm | 11 PIN : 28.0mm |
| 6 PIN : 15.3mm | 12 PIN : 30.5mm |
| 7 PIN : 17.8mm | 13 PIN : 33.1mm |
| 8 PIN : 20.4mm | 14 PIN : 35.6mm |
| 9 PIN : 22.9mm | |

Derating Curve (降功率曲线)

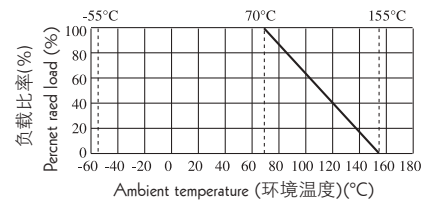

Circuit Structure (电路结构)



Package Power Ratings (包装功率等级)(W)

| Pkg. | Package Power Rating 包装功率等级 | Pkg. | Package Power Rating 包装功率等级 |
|------|--------------------------------|------|--------------------------------|
| 4 | 0.6W | 10 | 1.50W |
| 5 | 0.75W | 11 | 1.65W |
| 6 | 0.9W | 12 | 1.80W |
| 7 | 1.05W | 13 | 1.95W |
| 8 | 1.20W | 14 | 2.10W |
| 9 | 1.35W | | |

* Custom Design Circuit could be available on a case to case basis. (可按客户特殊要求定制)

| Power Rating (功率) 70°C | Max. Working Voltage 最大工作电压 | Max. Overload Voltage 最大过负荷电压 | Dielectric Withstanding Voltage 绝缘耐压 | Resistance Range 阻值范围 | Tolerance 公差 | Operating Temperature 工作温度范围 |
|---------------------------|--------------------------------|----------------------------------|---|--------------------------|-----------------|---------------------------------|
| A: 0.25W | | | | 10Ω ~ 1MΩ | ±2% | -55°C ~ +155°C |
| B: 0.4W | 100V | 150V | 200V | 10Ω ~ 1MΩ | ±5% | |
| R: 0.25W | | | | 100Ω ~ 10KΩ | | |

Marking (Single Value) [标示: (单个阻值)]:

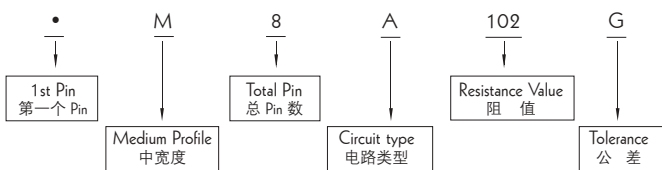

Performance Specifications (性能)

| | |
|---|--|
| Temperature coefficient 温度系数 | 50Ω-1MΩ: ±100PPM/°C <50Ω & >1MΩ: ±250PPM/°C |
| Short-time overload 短时间过负荷 | $\Delta R/R \leq \pm(0.25\% + 0.1\Omega)$ |
| Insulation resistance 绝缘电阻 | $\geq 10,000M\Omega$ |
| Dielectric withstanding voltage 绝缘耐压 | No Evidence of flashover, arcing or insulation breakdown (无击穿、飞弧及可见机械损伤) |
| Terminal strength 端子强度 | $\Delta R/R \leq \pm(0.25\% + 0.1\Omega)$ |
| Soldering heat 耐焊接热 | $\Delta R/R \leq \pm(0.5\% + 0.1\Omega)$ |
| Solderability 可焊性 | Min. 95% coverage (最少 95% 覆盖率) |
| Thermal shock 热冲击 | $\Delta R/R \leq \pm(0.25\% + 0.1\Omega)$ |
| Temperature cycling 温度循环 | $\Delta R/R \leq \pm(0.5\% + 0.1\Omega)_{max}$ (最大) |
| Load life in humidity 湿度寿命 | $\Delta R/R \leq \pm(0.5\% + 0.1\Omega)$ |
| Load life 负载寿命 | $\Delta R/R \leq \pm(1\% + 0.1\Omega)$ |

Marking (Dual Value) [标示: (双阻类型)]:

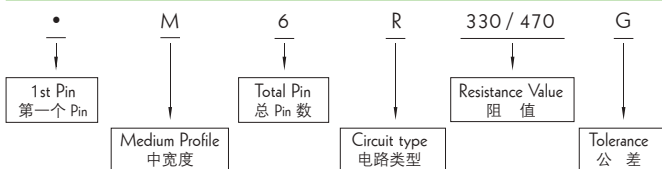

Dual Value(双阻型阻值系列) (R1/R2) (Ohm)

| | |
|-----------|-------------|
| 160 / 240 | 330 / 390 |
| 180 / 390 | 330 / 470 |
| 220 / 270 | 1.5K / 3.5K |
| 220 / 330 | 3.0K / 6.2K |

* Special Value available on a case to case basis. (另可按客户特殊要求订做)

Standard Packing of Resistor Network (网络电阻器的标准包装)



| Pins Pins 数 | Weight of 1,000pcs 1,000 只重量 | Qty. per Bag 每袋数量 | Qty. per Box 每盒数量 | Qty. per Carton 每箱数量 |
|----------------|---------------------------------|----------------------|----------------------|-------------------------|
| 4 | 240 | 100 | 1,000 | 30,000 |
| 5 | 300 | 100 | 1,000 | 30,000 |
| 6 | 360 | 100 | 1,000 | 30,000 |
| 7 | 420 | 100 | 1,000 | 30,000 |
| 8 | 480 | 100 | 1,000 | 30,000 |
| 9 | 540 | 50 | 500 | 15,000 |
| 10 | 610 | 50 | 500 | 15,000 |
| 11 | 670 | 50 | 500 | 15,000 |
| 12 | 730 | 50 | 500 | 15,000 |
| 13 | 790 | 50 | 500 | 15,000 |
| 14 | 850 | 50 | 500 | 15,000 |

Ordering Procedure (Example: RNM A type 10 PIN 2% 10KΩ B/B)

订购方式 (例如: RNM A 型 10 PIN 2% 10KΩ B/B)



Feature (特性)

- Miniature, high density packaging
小型高密度封装
- High reliability $R_{1}O_{2}$ paste
使用高稳定性 $R_{1}O_{2}$ 电阻材料

Application (应用)

- Control circuit V.C.R. (V.C.R.控制电路)
- Air-conditioner (空调)
- Computer, color TV (计算机, 彩电)
- Facsimile (传真机)



Dimension (尺寸) (mm)

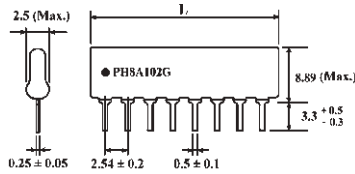

"•" indicate the 1st pin (表示第一脚位置)

Dimension of L (Max.) (L的最大尺寸)

| | |
|----------------|-----------------|
| 4 PIN : 10.2mm | 10 PIN : 25.4mm |
| 5 PIN : 12.7mm | 11 PIN : 28.0mm |
| 6 PIN : 15.3mm | 12 PIN : 30.5mm |
| 7 PIN : 17.8mm | 13 PIN : 33.1mm |
| 8 PIN : 20.4mm | 14 PIN : 35.6mm |
| 9 PIN : 22.9mm | |

Derating Curve (降功率曲线)

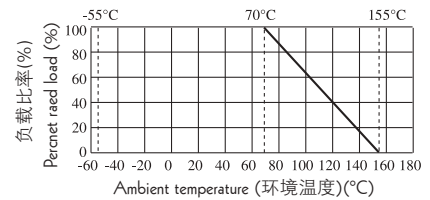

Circuit Structure (电路结构)

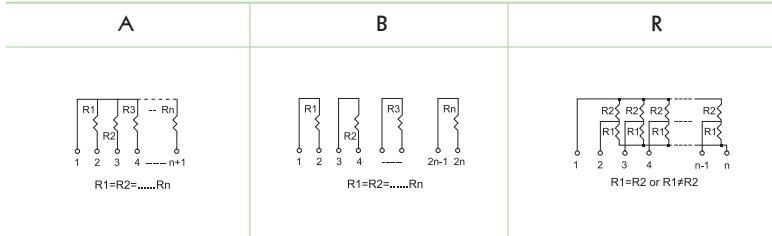

Package Power Ratings (包装功率等级)(W)

| Pkg. | Package Power Rating 包装功率等级 | Pkg. | Package Power Rating 包装功率等级 |
|------|--------------------------------|------|--------------------------------|
| 4 | 0.8W | 10 | 2.0W |
| 5 | 1.0W | 11 | 2.2W |
| 6 | 1.2W | 12 | 2.4W |
| 7 | 1.4W | 13 | 2.6W |
| 8 | 1.6W | 14 | 2.8W |
| 9 | 1.8W | | |

* Custom Design Circuit could be available on a case to case basis. (可按客户特殊要求定制)

| Power Rating (功率) 70°C | Max. Working Voltage 最大工作电压 | Max. Overload Voltage 最大过负荷电压 | Dielectric Withstanding Voltage 绝缘耐压 | Resistance Range 阻值范围 | Tolerance 公差 | Operating Temperature 工作温度范围 |
|---------------------------|--------------------------------|----------------------------------|---|--------------------------|-----------------|---------------------------------|
| A: 0.3W | 100V | 150V | 200V | 10Ω ~ 1MΩ | ±2% ±5% | -55°C ~ +155°C |
| B: 0.5W | | | | 10Ω ~ 1MΩ | | |
| R: 0.3W | | | | 100Ω ~ 10KΩ | | |

Marking (Single Value) [标示: (单个阻值)]:

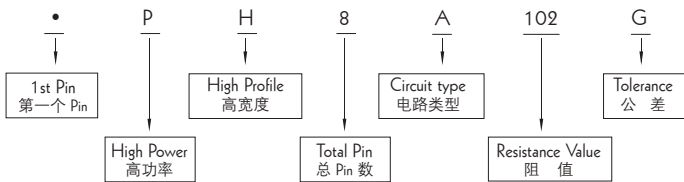

Marking (Dual Value) [标示: (双阻类型)]:

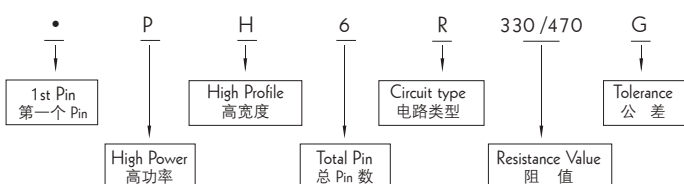

Dual Value(双阻型阻值系列) (R1/R2) (Ohm)

| | |
|-----------|-------------|
| 160 / 240 | 330 / 390 |
| 180 / 390 | 330 / 470 |
| 220 / 270 | 1.5K / 3.5K |
| 220 / 330 | 3.0K / 6.2K |

* Special Value available on a case to case basis. (另可按客户特殊要求订做)

Performance Specifications (性能)

| | |
|---|---|
| Temperature coefficient 温度系数 | 50Ω-1MΩ: ±100PPM/°C < 50Ω & > 1MΩ: ±250PPM/°C |
| Short-time overload 短时间过负荷 | $\Delta R/R \leq \pm(0.25\% + 0.1\Omega)$ |
| Insulation resistance 绝缘电阻 | $\geq 10,000M\Omega$ |
| Dielectric withstanding voltage 绝缘耐压 | No evidence of flashover mechanical damage, arcing or insulation break down. (无击穿、飞弧及可见机械损伤) |
| Terminal strength 端子强度 | $\Delta R/R \leq \pm(0.25\% + 0.1\Omega)$ |
| Soldering heat 耐焊接热 | $\Delta R/R \leq \pm(0.5\% + 0.1\Omega)$ |
| Solderability 可焊性 | Min. 95% coverage (最少 95% 覆盖率) |
| Thermal shock 热冲击 | $\Delta R/R \leq \pm(0.25\% + 0.1\Omega)$ |
| Temperature cycling 温度循环 | $\Delta R/R \leq \pm(0.5\% + 0.1\Omega)_{max}$ (最大) |
| Load life in humidity 湿度寿命 | $\Delta R/R \leq \pm(0.5\% + 0.1\Omega)$ |
| Load life 负载寿命 | $\Delta R/R \leq \pm(1\% + 0.1\Omega)$ |

Standard Packing of Resistor Network (网络电阻器的标准包装)

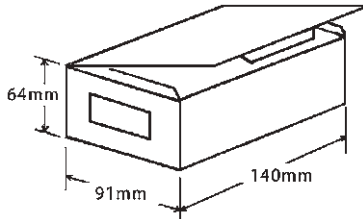

| Pins Pins 数 | Weight of 1,000pcs 1,000 只重量 | Qty. per Bag 每袋数量 | Qty. per Box 每盒数量 | Qty. per Carton 每箱数量 |
|----------------|---------------------------------|----------------------|----------------------|-------------------------|
| 4 | 330 | 100 | 1,000 | 30,000 |
| 5 | 410 | 100 | 1,000 | 30,000 |
| 6 | 490 | 100 | 1,000 | 30,000 |
| 7 | 570 | 100 | 1,000 | 30,000 |
| 8 | 660 | 50 | 1,500 | 15,000 |
| 9 | 760 | 50 | 500 | 15,000 |
| 10 | 870 | 50 | 500 | 15,000 |
| 11 | 950 | 50 | 500 | 15,000 |
| 12 | 1030 | 50 | 500 | 15,000 |
| 13 | 1130 | 50 | 500 | 15,000 |
| 14 | 1210 | 50 | 500 | 15,000 |

Ordering Procedure (Example: RPH A type 10 PIN 2% 10KΩ B/B)

订购方式 (例如: RPH A 型 10 PIN 2% 10KΩ B/B)

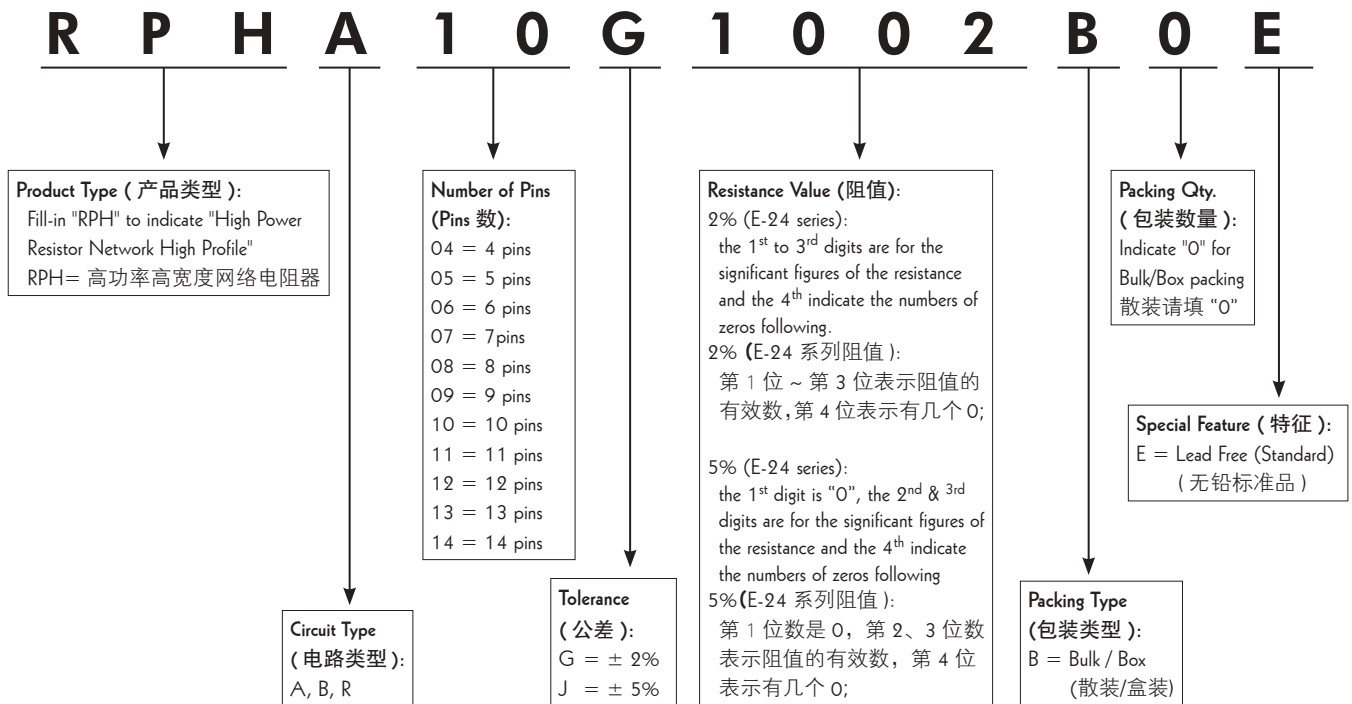

Feature (特性)

- Miniature, high density packaging
小型高密度封装
- High reliability $R_{10}O_2$ paste
使用高稳定性 $R_{10}O_2$ 电阻材料

Application (应用)

- Control circuit V.C.R. (V.C.R.控制电路)
- Air-conditioner (空调)
- Computer, color TV (计算机, 彩电)
- Facsimile (传真机)

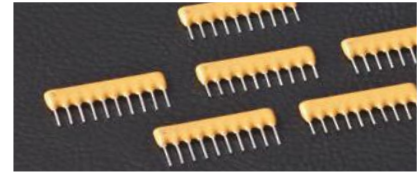

Dimension (尺寸) (mm)



Derating Curve (降功率曲线)

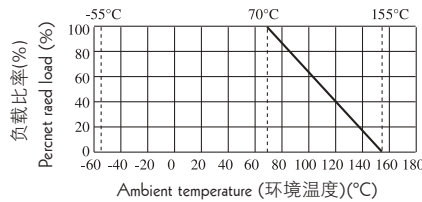

Marking (Single Value) [标示 (单一值)]



Circuit Structure (电路结构)

| SN0001 | SN0002 | SN0003 | SN0004 |
|---|---|--|---|
| | | | |
| R1=500Ω ±5% R2=40K ±5% (TO R3 ±1%) R3=10K ±5% R4=50K ±5% R5=R7=100K ±5% (R6 TO R7 ±1%) | R1=33KΩ ±5% R2=22KΩ ±5% | R3=9K1 R4=120K R5=1K5 R7=52K5 R1=14K R14=24K R15=1K5 R5=R6=7K5 R10=R11=R12=20K R13=11K | R1=520Ω R2=70Ω R3=121Ω R4=249Ω R5=1K33 R6=619K R7=174Ω R8=75Ω |
| Dimension of L (max) 尺寸 L (最大) 10PINS:25.4mm H (max) 5.08mm Power Rating at 70°C 功率 70°C 0.2W Max Working Voltage 最大工作电压 100V Max Overload Voltage 最大过负荷电压 150V Operating Temperature 工作温度 -55°C~+155°C | Dimension of L (max) 尺寸 L (最大) 10PINS:25.4mm H (max) 5.08mm Power Rating at 70°C 功率 70°C 0.2W Max Working Voltage 最大工作电压 100V Max Overload Voltage 最大过负荷电压 150V Operating Temperature 工作温度 -55°C~+155°C | Dimension of L (max) 尺寸 L (最大) 10PINS:43.2mm H (max) H (最大) 6.35mm Tolerance 公差 ±1% Power Rating at 70°C 功率 70°C 0.125W Max Working Voltage 最大工作电压 100V Max Overload Voltage 最大过负荷电压 200V Operating Temperature 工作温度 -55°C~+155°C | Dimension of L (max) 尺寸 L (最大) 9PINS:22.9mm H (max) H (最大) 5.08mm Tolerance 公差 ±1% Power Rating at 70°C 功率 70°C 0.125W Max Working Voltage 最大工作电压 100V Max Overload Voltage 最大过负荷电压 150V Operating Temperature 工作温度 -55°C~+155°C |

* Custom Design Circuit could be available on a case to case basis (可提供客户特殊要求之线路产品)

Performance Specifications (性能)

| | | | |
|---|---|---------------------------------|--------------------------------|
| Temperature coefficient 温度系数 | 50Ω ~ 2.2MΩ: ±100PPM, <50Ω & >2.2MΩ: ±250PPM | Terminal strength 端子强度 | ΔR/R ≤ ±(0.25% + 0.1Ω) |
| Short-time overload 短时间过负荷 | ΔR/R ≤ ±(0.25% + 0.1Ω) | Soldering heat 耐焊接热 | ΔR/R ≤ ±(0.5% + 0.1Ω) |
| Insulation resistance 绝缘电阻 | ≥ 10,000MΩ | Solderability 可焊性 | Min. 95% coverage (最少 95% 覆盖率) |
| Dielectric withstanding voltage 绝缘耐压 | No evidence of flashover mechanical damage, arcing or insulation break down. 无击穿、电弧及可见机械损伤 | Thermal shock 热冲击 | ΔR/R ≤ ±(0.25% + 0.1Ω) |
| | | Temperature cycling 温度循环 | ΔR/R ≤ ±(0.5% + 0.1Ω)max(最大) |
| | | Humidity (Steady State) 恒定湿热 | ΔR/R ≤ ±(0.5% + 0.1Ω) |
| | | Load life 负载寿命 | ΔR/R ≤ ±(1% + 0.1Ω) |

Ordering Procedure (Example: RPL Special Network N0001 10PIN B/B)

订购方式 (例如: RPL 特殊网络电阻 N0001 10PIN B/B)

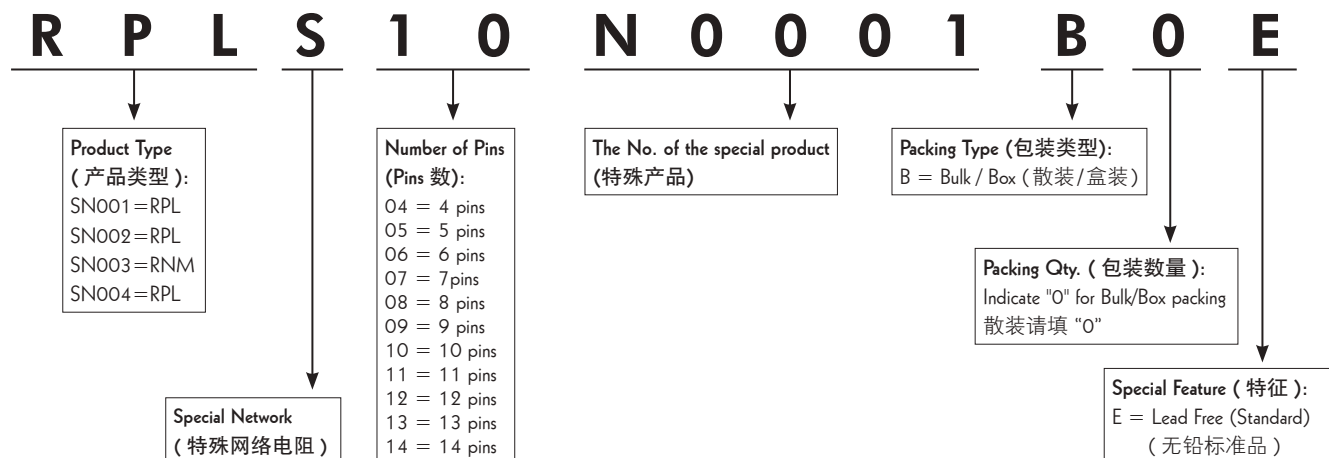

Feature (特性)

- Low noise termination for CMOS. CMOS 低噪声
- Combined resistors and capacitors in SIP Package saves space 在排列电阻的基板上贴电容
- Reduced insertion time 减少插件时间, 提高效率
- Insulation resistance testing for reliability 可靠的绝缘电阻的测试

Application (应用)

- Microwave ovens 微波炉
- Color TV 电视
- Radio 收音机

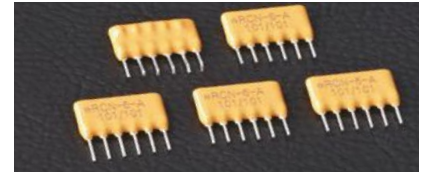

Electrical Characteristics-Resistors (电阻特性)

| Resistance Range 阻值范围 | Resistance Tolerance 阻值公差 | Operating Voltage 工作电压 |
|--------------------------|------------------------------|---------------------------|
| 50Ω~1MΩ | ±5% | 50V |

Electrical Characteristics- Capacitor (电容特性)

| Capacitance Dielectric 电容介质 | Capacitance Range 电容范围 | Capacitance Tolerance 电容公差 | Capacitance Voltage 电容电压 |
|--------------------------------|---------------------------|-------------------------------|-----------------------------|
| NPO | 39pF~270pF | ±10% | 50V |
| X7R | >270pF~0.1μF | ±20% | |

Circuit Structure (电路结构)

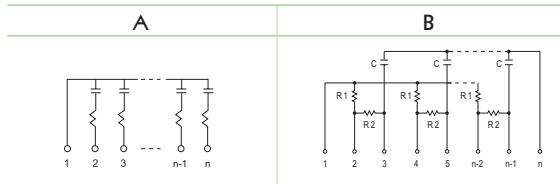

* Custom Design Circuit could be available on a case to case basis
(可提供客户特殊要求之线路产品)

Marking (Single Value) [标示 (单一值)]

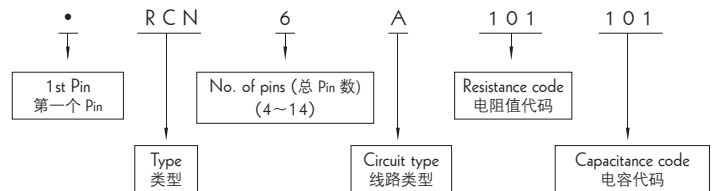

Dimension (尺寸) (mm):

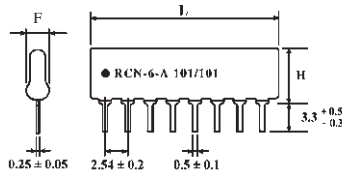

"•" indicate the 1st pin (表示第一脚位置)

| Type 类型 | H (mm) | F (mm) | L | |
|---------|-----------|-----------|---------------|----------------|
| RCH | 7.62 Max. | 3.81 Max. | 4 PIN: 10.2mm | 10 PIN: 25.4mm |
| RCN | 8.89 Max. | 3.81 Max. | 5 PIN: 12.7mm | 11 PIN: 28.0mm |
| | | | 6 PIN: 15.3mm | 12 PIN: 30.5mm |
| | | | 7 PIN: 17.8mm | 13 PIN: 33.1mm |
| | | | 8 PIN: 20.4mm | 14 PIN: 35.6mm |
| | | | 9 PIN: 22.9mm | |

Ordering Procedure (Example: RCN A 6PIN 100Ω/100pF B/B)

订购方式 (例如: RCN A 6PIN 100Ω/100pF B/B)

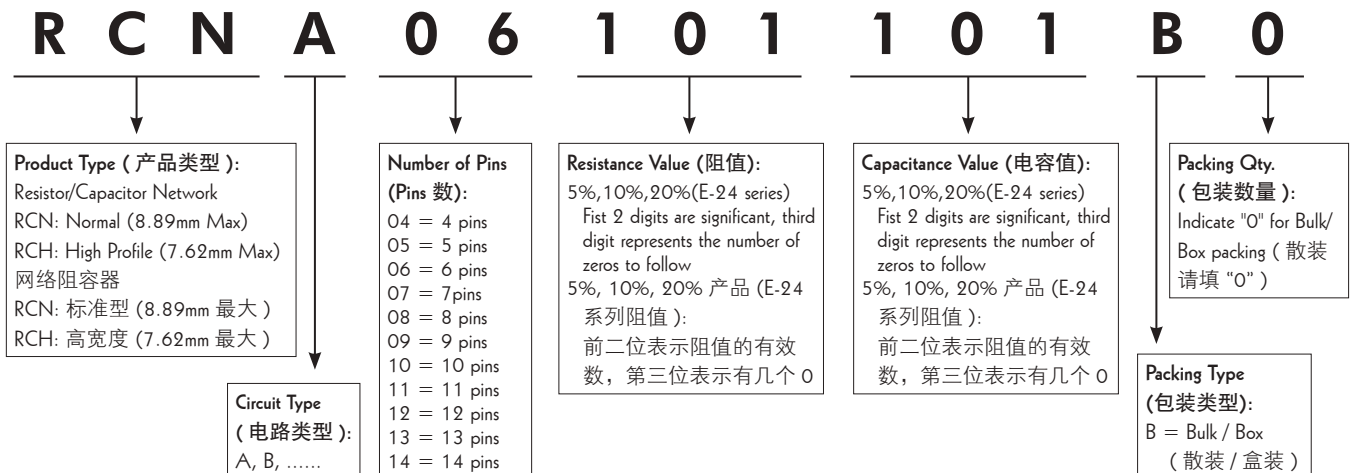

Feature (特性)

- Integrates capacitor function if one package 集成电容器作用
- Design reduces termination noise 静音设计
- Reduced insertion time 减少插件时间, 提高效率
- Popular standard capacitance values available 通用标准电容值
- Isolated, bussed and dual-bussed circuits available 隔离的总线和双总线电路

Application (应用)

- Microwave ovens 微波炉
- Color TV 电视
- Radio 收音机

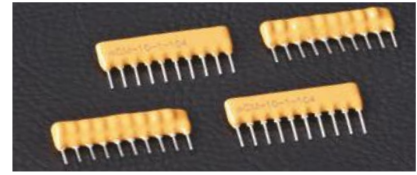

Electrical Characteristics- Capacitor (电容特性)

| Capacitance Dielectric 电容介质 | Capacitance Range 电容范围 | Capacitance Tolerance 电容公差 | Capacitance Voltage 电容电压 |
|--------------------------------|---------------------------|-------------------------------|-----------------------------|
| NPO | 39pF~270pF | ±10% | 50V |
| X7R | >270pF~0.1μF | ±20% | |

Dimension (尺寸) (mm):

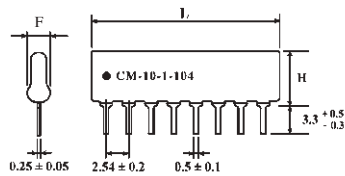

"•" indicate the 1st pin (示第一脚位置)

Dimension of L (Max.) (L 的最大尺寸)

| Type 类型 | H (mm) | F (mm) |
|---------|---------|---------|
| CNM | 6.35 | 3.81 |
| | Max. 最大 | Max. 最大 |
| CNH | 7.62 | 3.81 |
| | Max. 最大 | Max. 最大 |

| | |
|----------------|-----------------|
| 4 PIN : 10.2mm | 10 PIN : 25.4mm |
| 5 PIN : 12.7mm | 11 PIN : 28.0mm |
| 6 PIN : 15.3mm | 12 PIN : 30.5mm |
| 7 PIN : 17.8mm | 13 PIN : 33.1mm |
| 8 PIN : 20.4mm | 14 PIN : 35.6mm |
| 9 PIN : 22.9mm | |

Marking (Single Value) [标示 (单个阻值)]



Circuit Structure (电路结构)

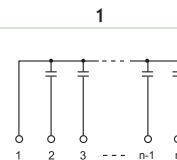

* Custom Design Circuit could be available on a case to case basis (可提供客户特殊要求之线路产品)

Ordering Procedure (Example: CNM 1 10PIN 0.1μF B/B)

订购方式 (例如: CNM 1 10PIN 0.1μF B/B)



Feature (特性)

- Small size, Light weight 小尺寸, 重量轻
- High stability, Reliability 高稳定性, 高可靠性
- Max working voltage 10KV 最大工作电压可达10KV
- Used in microwave ovens, induction cooker, High Voltage Power Supply, Laser light control circuit and other applications
用于微波炉, 电磁炉, 高压电源, 激光控制电路和其他应用程序

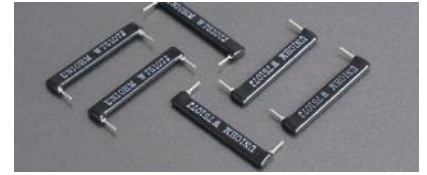

Dimension (尺寸) (mm)

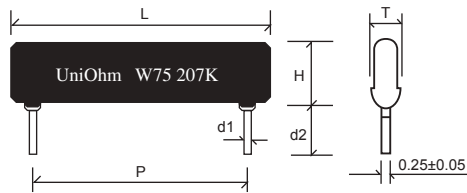

Derating Curve & Specification (降功率曲线和性能)

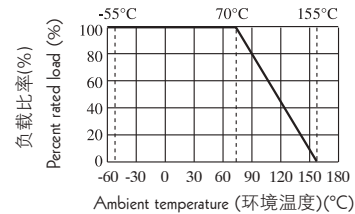

| Part No. 料号 | Type 类型 | Power rating 功率 70°C | Dimension (尺寸) (mm) | | | | | | Max Working Voltage 最大工作电压 | Dielectric Withstanding Voltage 绝缘耐压 | Resistance Range 阻值范围 |
|----------------|------------|-------------------------|---------------------|---------------|--------|------------------------------------|---------------|---------------|-------------------------------|---|--------------------------|
| | | | P±0.5 | L(max) L最大 | d1±0.1 | d2 ^{+0.5} _{-0.2} | H(max) H最大 | T(max) T最大 | | | |
| HFR0W2 | HFR-50 | 0.5W | 17.8 | 20.4 | 0.5 | 3.5 | 5.08 | 2.5 | 5KV | 500V | 1M~1GΩ |
| HFR007 | HFR-75 | 0.75W | 22.9 | 25.4 | 0.5 | 3.5 | 5.08 | 2.5 | 10KV | 500V | 1M~1GΩ |
| HFR01W | HFR-100 | 1W | 27.9 | 30.5 | 0.5 | 3.5 | 5.08 | 2.5 | 10KV | 500V | 1M~1GΩ |

Performance Specification (性能)

| | | | | | |
|-------------------------|------|-------------------------------|-------------------------|------|-------------------|
| Temperature coefficient | 温度系数 | ±200PPM/°C | Humidity (steady State) | 恒定湿热 | ΔR/R±(1.0%+0.1 Ω) |
| Terminal strength | 端子强度 | ΔR/R≤±(1%+0.1Ω) | Load life in humidity | 湿度寿命 | ΔR/R±(3.0%+0.1Ω) |
| Soldering heat | 耐焊接热 | ΔR/R±(1%+0.1 Ω) | Load life | 负载寿命 | ΔR/R±(3.0%+0.1Ω) |
| Solderability | 可焊性 | Min.95% coverage (最少 95% 覆盖率) | Insulation resistance | 绝缘电阻 | ≥10,000MΩ |
| Temperature cycling | 温度循环 | ΔR/R±(1%+0.1 Ω) | Thermal shock | 热冲击 | ΔR/R±(1%+0.1Ω) |

Ordering Procedure (Example: HFR 0.75W 10% 10M B/B)

订购方式 (例如: HFR 0.75W 10% 10M B/B)

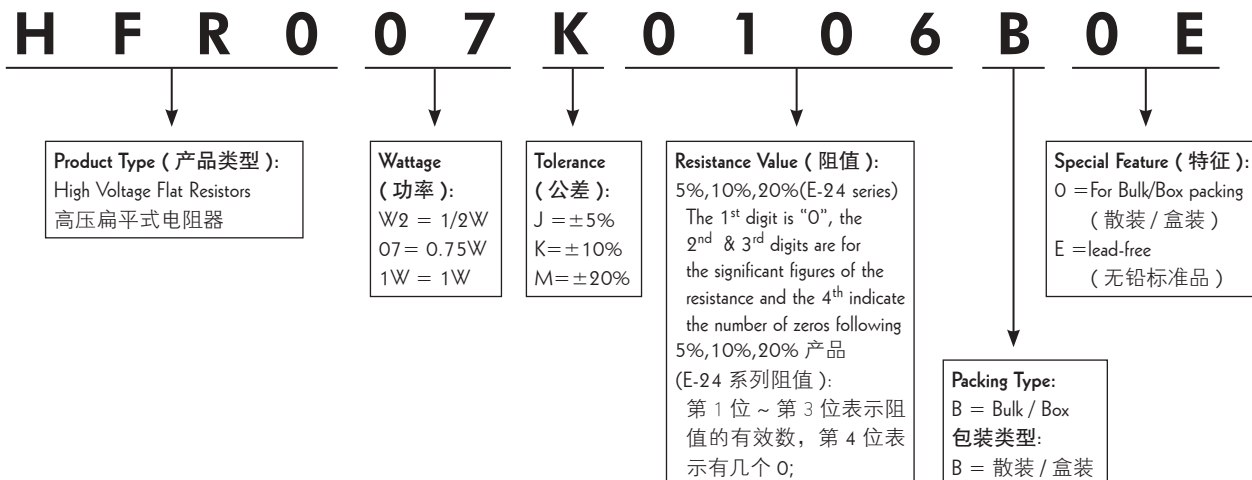

Feature (特性)

- High quality performance 高品质
- Great economy 低成本
- Flame retardant type available 可提供不燃性涂装
- Automatically insertable 适用自动化插件



| Part No. 料号 | Type 类型 | Power Rating 功率 70°C | Dimension (尺寸) (mm) | | | | Max. Working Voltage 最大工作电压 | Max. Overload Voltage 最大过负荷电压 | Dielectric Withstanding Voltage 绝缘耐压 | Resistance Range 阻值范围 |
|--|------------|----------------------------|---------------------|----------|--------|-------|-----------------------------------|-------------------------------------|--|--------------------------|
| | | | D | L | d±0.05 | H ± 3 | | | | |
| Normal Size (正常尺寸) | | | | | | | | | | |
| CFROW8 | CFR-12 | 1/8W | 1.9±0.3 | 3.3±0.3 | 0.45 | 28 | 200V | 400V | 400V | 1Ω ~ 1MΩ |
| CFROW4 | CFR-25 | 1/4W | 2.2±0.3 | 6.5±1.0 | 0.54 | 28 | 250V | 500V | 500V | 1Ω ~ 10MΩ |
| CFROW2 | CFR-50 | 1/2W | 3.0±0.5 | 9.5±1.0 | 0.54 | 28 | 350V | 700V | 700V | 1Ω ~ 10MΩ |
| CFR01W | CFR-100 | 1W | 5.0±0.5 | 15.5±1.0 | 0.70 | 28 | 500V | 1000V | 1000V | 1Ω ~ 10MΩ |
| CFR02W | CFR-200 | 2W | 6.0±0.5 | 17.5±1.0 | 0.75 | 28 | 500V | 1000V | 1000V | 1Ω ~ 10MΩ |
| Small Size & Extra Small Size (小型及超小型尺寸) | | | | | | | | | | |
| CFR0S4 | CFR-25-S | 1/4W | 1.9±0.3 | 3.3±0.3 | 0.45 | 28 | 200V | 400V | 400V | 1Ω ~ 1MΩ |
| CFR0U2 | CFR-50-SS | 1/2W | 2.2±0.5 | 6.5±1.0 | 0.54 | 28 | 250V | 500V | 250V | 1Ω ~ 10MΩ |
| CFR0S2 | CFR-50-S | 1/2W | 3.0±0.5 | 9.0±1.0 | 0.54 | 28 | 350V | 700V | 700V | 1Ω ~ 10MΩ |
| CFR01S | CFR-100-S | 1W | 4.0±0.5 | 11.5±1.0 | 0.65 | 28 | 500V | 1000V | 1000V | 1Ω ~ 10MΩ |
| CFR02S | CFR-200-S | 2W | 5.0±0.5 | 15.5±1.0 | 0.70 | 28 | 500V | 1000V | 1000V | 1Ω ~ 10MΩ |
| CFR03S | CFR-300-S | 3W | 6.0±0.5 | 17.5±1.0 | 0.75 | 28 | 500V | 1000V | 1000V | 1Ω ~ 10MΩ |

- Standard E-24 series values in ±5%, ±10% & ±20% tolerance
标准E-24系列公差为±5%、±10% & ±20%阻值
- Standard Beige base color, Light Brown color for CFR01S, CFR02S & CFR03S
正常尺寸产品涂标准米黄色底漆, CFR01S, CFR02S & CFR03S涂浅棕色底漆
- Standard Grayish-green base color (Non-Flammable coating) for CFR0U2 (CFR-50-SS)
CFR0U2 (CFR-50-SS)涂标准灰绿色(不燃性)底漆
- For any special inquiry such as too Low or too High ohmic values is available on a case to case basis
特殊要求, 含超高、超低阻值也可特别安排生产

Derating Curve (降功率曲线)

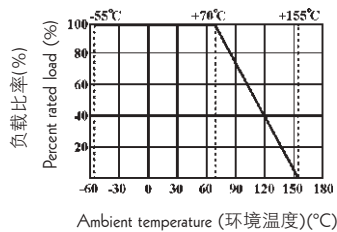

Performance Specification (性能)

| | |
|--|--|
| Temperature coefficient 温度系数 | ±300PPM/°C for ≤10Ω; ±450PPM/°C for 11Ω ~ 99KΩ; 0 ~ -700PPM/°C for 100KΩ ~ 1MΩ; 0 ~ -1500PPM/°C for 1.1MΩ ~ 10MΩ. |
| Short-time overload 短时间过负荷 | ΔR/R ≤ ±(1%+0.05Ω), with no evidence of mechanical damage (无可见机械损伤) |
| Insulation resistance 绝缘电阻 | ≥10,000MΩ |
| Dielectric withstanding voltage 绝缘耐压 | No evidence of flashover, mechanical damage, arcing or insulation breakdown 无击穿、飞弧及可见机械损伤 |
| Terminal strength 端子强度 | No evidence of mechanical damage (无可见机械损伤) |
| Soldering heat 耐焊接热 | ΔR/R ≤ ±(1%+0.05Ω), with no evidence of mechanical damage (无可见机械损伤) |
| Solderability 可焊性 | Min. 95% coverage (最少 95% 覆盖率) |
| Resistance to solvent 耐溶剂 | No deterioration of protective coating and markings (包封层, 色码完整) |
| Temperature cycling 温度循环 | ΔR/R ≤ ±(1%+0.05Ω), with no evidence of mechanical damage (无可见机械损伤) |
| Load life in humidity 湿度寿命 | Normal type (正常尺寸): ΔR/R ± 3% for <100KΩ, ±5% for ≥100KΩ; Flame retardant type (不燃性): ΔR/R ± 5% for <100KΩ, ±10% for ≥100KΩ |
| Load life 负载寿命 | Normal type (正常尺寸): ΔR/R ± 2% for <56KΩ, ±3% for ≥56KΩ; Flame retardant type (不燃性): ΔR/R ± 5% for <100KΩ, ±10% for ≥100KΩ |

Ordering Procedure (Example: CFR 1/4WS Flame Retardant type 5% 10KΩ T/B-5000)

订购方式 (例如: CFR 1/4WS 不燃性 5% 10KΩ T/B-5000)



Feature (特性)

- EIA standard color coding. EIA标准色码
- Flame retardant type available 可供不燃性涂装
- Low noise & voltage coefficient 噪声低, 电压系数小
- Low temperature coefficient range 温度系数低
- Multiple epoxy coating on vacuum-deposited metal film provides superior moisture protection 真空溅射金属皮膜涂多层环氧树脂, 防水性效果好
- Nichrome resistive element provides stable performance in various environments 镍基金属膜层的采用使各项性能更加稳定

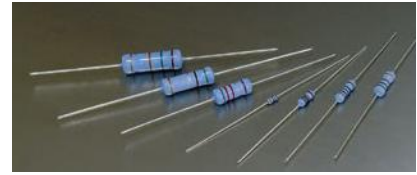

| Part No. 料号 | Type 类型 | Power Rating 功率 70°C | Dimension (尺寸) (mm) | | | |
|---|------------|----------------------------|---------------------|----------|----------|-------|
| | | | D | L | d ± 0.05 | H ± 3 |
| Normal Size (正常尺寸) | | | | | | |
| MFROW8 | MF-12 | 1/8W | 1.9±0.3 | 3.3±0.3 | 0.45 | 28 |
| MFROW4 | MF-25 | 1/4W | 2.2±0.3 | 6.5±1.0 | 0.54 | 28 |
| MFROW2 | MF-50 | 1/2W | 3.0±0.5 | 9.5±1.0 | 0.54 | 28 |
| MFR01W | MF-100 | 1W | 4.5±0.5 | 11.5±1.0 | 0.65 | 28 |
| MFR02W | MF-200 | 2W | 5.0±0.5 | 15.5±1.0 | 0.70 | 28 |
| MFR03W | MF-300 | 3W | 6.0±0.5 | 17.5±1.0 | 0.75 | 28 |
| Small Size & Extra Small Size (小型及超小型尺寸) | | | | | | |
| MFR0S4 | MF-25-S | 1/4W | 1.9±0.5 | 3.3±0.3 | 0.45 | 28 |
| MFR004 | MF-40-SS | 0.4W | 1.9±0.5 | 3.3±0.3 | 0.45 | 28 |
| MFR0U2 | MF-50-SS | 1/2W | 2.2±0.5 | 6.5±0.5 | 0.54 | 28 |
| MFR0S2 | MF-50-S | 1/2W | 2.7±0.5 | 9.0±1.0 | 0.54 | 28 |
| MFR006 | MF-60-S | 0.6W | 2.2±0.5 | 6.5±1.0 | 0.54 | 28 |
| MFR01S | MF-100-S | 1WS | 3.5±0.5 | 9.5±1.0 | 0.65 | 28 |
| MFR02S | MF-200-S | 2WS | 4.0±0.5 | 11.5±1.0 | 0.65 | 28 |
| MFR03S | MF-300-S | 3WS | 5.0±0.5 | 15.5±1.0 | 0.7 | 28 |

Derating Curve (降功率曲线)



Standard Non-flammable coating for Small size type (except MF-50-S). [小尺寸标准不燃性涂装 (MF-50-S除外)]

| Part No. 料号 | Type 类型 | Dielectric Withstanding Voltage 绝缘耐压 | Max. Working Voltage 最大工作电压 | Max. Overload Voltage 最大过负荷电压 | Standard Order 标准品 | | | Special Order 特殊订购品 | | |
|----------------|------------|---|--------------------------------|----------------------------------|--------------------|-------------|--------------------------|---------------------|-------------|--------------------------|
| | | | | | Tolerance 公差 | TCR 温度系数 | Resistance Range 阻值范围 | Tolerance 公差 | TCR 温度系数 | Resistance Range 阻值范围 |
| MFROW8 | MF-12 | 400V | 200V | 400V | ±1% | ± 50 | 10Ω-1MΩ | ± 0.25% | ± 15 | 51.1Ω ~ 200KΩ |
| MFR0S4 | MF-25-S | 200V | 200V | 400V | ±2% | ± 100 | 10Ω-1MΩ | ± 0.5% | ± 25 | 51.1Ω ~ 511KΩ |
| MFR004 | MF-40-SS | | | | ±5% | ± 200 | 1Ω-1MΩ | ± 0.5% | ± 50 | 51.1Ω ~ 511KΩ |
| MFROW4 | MF-25 | 500V | 250V | 500V | ±1% | ± 50 | 10Ω-1MΩ | ± 0.1% | ± 15 | 10Ω ~ 1MΩ |
| MFR0U2 | MF-50-SS | 250V | 250V | 500V | ±2% | ± 100 | 1Ω-1MΩ | ± 0.25% | ± 25 | 10Ω ~ 1MΩ |
| MFR006 | MF-60-S | | | | ±5% | ± 200 | 1Ω-1MΩ | ± 0.5% | ± 50 | 10Ω ~ 1MΩ |
| MFR0S2 | MF-50-S | 700V | 350V | 700V | ±1% | ± 50 | 10Ω-1MΩ | ± 0.1% | ± 15 | 100Ω ~ 330KΩ |
| MFROW2 | MF-50 | | | | ±2% | ± 100 | 10Ω-1MΩ | ± 0.25% | ± 25 | 51.1Ω ~ 511KΩ |
| MFR01W | MF-100 | 1000V | 500V | 1000V | ±5% | ± 200 | 1Ω-1MΩ | ± 0.5% | ± 50 | 10Ω ~ 1MΩ |
| MFR01S | MF-100-S | | | | 350V | 350V | 700V | ±1% | ± 50 | 51.1Ω-1MΩ |
| MFR02S | MF-200-S | 350V | 500V | 1000V | ±2% | ± 100 | 51.1Ω-1MΩ | ± 0.25% | ± 25 | 51.1Ω ~ 511KΩ |
| MFR03S | MF-300-S | 350V | 500V | 1000V | ±5% | ± 200 | 1Ω-1MΩ | ± 0.5% | ± 50 | 51.1Ω ~ 1MΩ |

Performance Specification (性能)

| | | |
|---------------------------------|--------|--|
| Temperature coefficient | 温度系数 | according to page 52 (参考第 52 页) |
| Short-time overload | 短时间过负荷 | $\Delta R/R \leq \pm(0.5\%+0.05\Omega)$, with no evidence of mechanical damage (无可见机械损伤) |
| Dielectric withstanding voltage | 绝缘耐压 | With no evidence of flashover, mechanical damage, arcing or insulation breakdown 无击穿、飞弧及可见机械损伤 |
| Pulse overload | 脉冲过负荷 | $\Delta R/R \leq \pm(1\%+0.05\Omega)$, with no evidence of mechanical damage (无可见机械损伤) |
| Terminal strength | 端子强度 | No evidence of mechanical damage (无可见机械损伤) |
| Soldering heat | 耐焊接热 | $\Delta R/R \leq \pm(1\%+0.05\Omega)$, with no evidence of mechanical damage (无可见机械损伤) |
| Solderability | 可焊性 | Min. 95% coverage (最少 95% 覆盖率) |
| Resistance to solvent | 耐溶剂 | No deterioration of protective coating and marking (包封层, 色码完整) |
| Temperature cycling | 温度循环 | $\Delta R/R \leq \pm(1\%+0.05\Omega)$, with no evidence of mechanical damage (无可见机械损伤) |
| Load life in humidity | 湿度寿命 | Normal type (普通型): $\Delta R/R \leq \pm 1.5\%$; Flame retardant type (阻燃型): $\Delta R/R \leq \pm 5\%$. |
| Load life | 负载寿命 | Normal type (普通型): $\Delta R/R \leq \pm 1.5\%$; Flame retardant type (阻燃型): $\Delta R/R \leq \pm 5\%$. |

Current Noise Level (电流噪声水平)

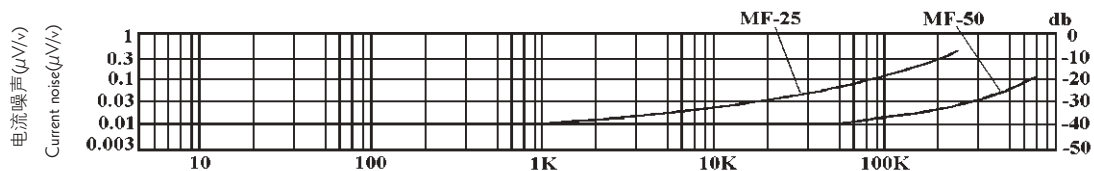

Ordering Procedure (Example: MFR 1/8W 1% 50PPM 47.5KΩ T/R-5000)

订购方式 (例如: MFR 1/8W 1% 50PPM 47.5KΩ T/R-5000)

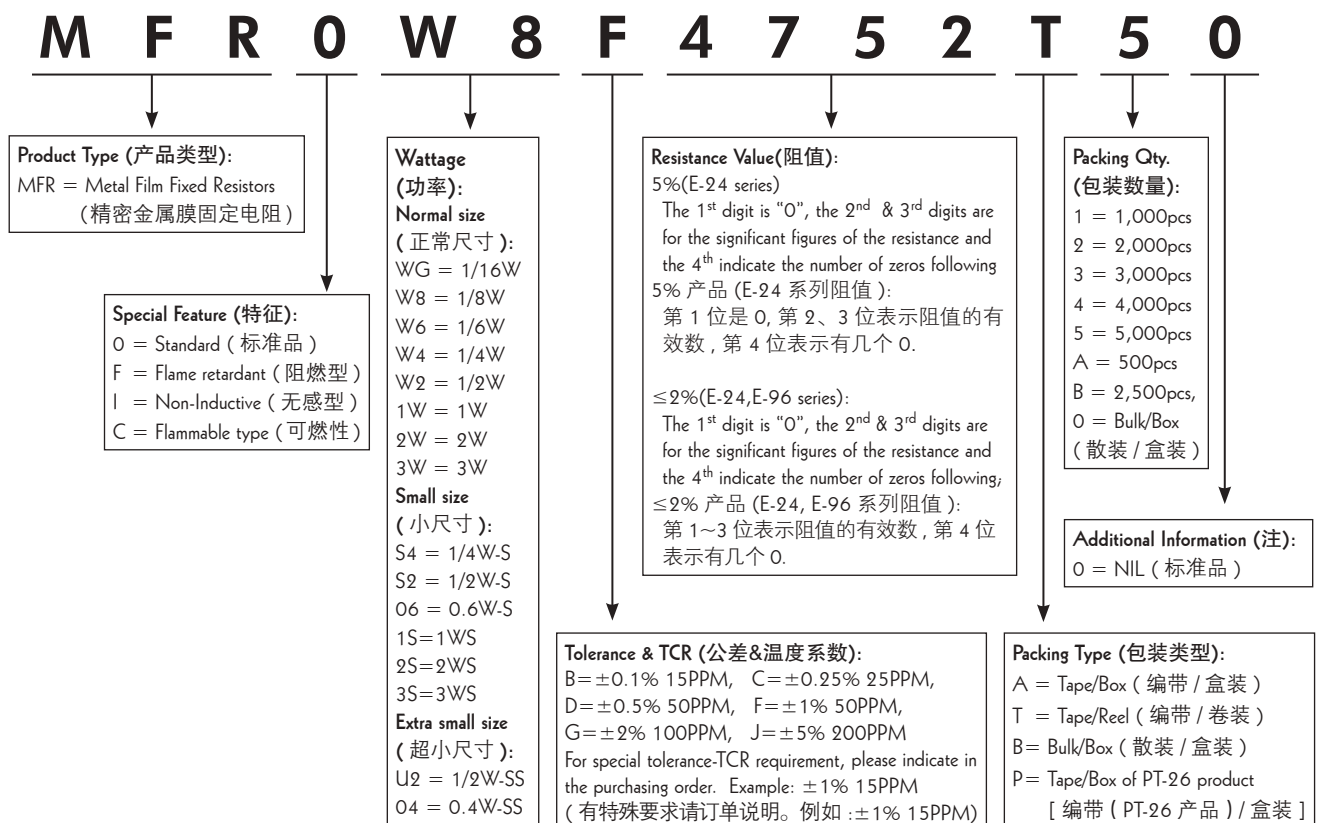

Feature (特性)

- High power in small body size 小体积，大功率
- Excellent flame Retardant coating 优异的阻燃封装
- Non-Inductive type available 可提供无感型



Dimension (尺寸) (mm)



Derating Curve & Specification (降功率曲线及性能)

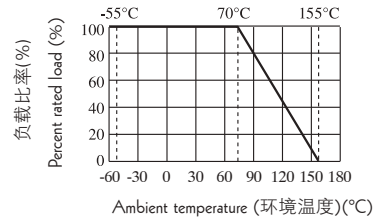

| Part No. 料号 | Type 类型 | Power rating 功率 70°C | Dimension (尺寸) (mm) | | | | Max Working Voltage 最大工作电压 | Dielectric Withstanding Voltage 绝缘耐压 | Max Overload Voltage 最大过负荷电压 | Resistance Range 阻值范围 | Tolerance 公差 |
|----------------|------------|----------------------------|---------------------|-----|--------|-----|-------------------------------|---|---------------------------------|--------------------------|-----------------|
| | | | D±0.5 | L±1 | d±0.05 | H±3 | | | | | |
| CPR0W2 | CPR-50 | 1/2W | 2.2 | 6.5 | 0.55 | 28 | 300V | 500V | 700V | 1Ω~10M | |
| CPR01W | CPR-100 | 1W | 3.5 | 9.5 | 0.55 | 28 | 500V | 700V | 1000V | 1Ω~10M | ±2%, ±5% |
| CPR02W | CPR-200 | 2W | 4.5 | 11 | 0.65 | 28 | 500V | 1000V | 1000V | 1Ω~10M | |

Performance Specification (性能)

| | | | |
|---------------------------------|---|---------------------------------|---|
| Temperature coefficient 温度系数 | ≤10Ω: ±300PPM 11Ω~99K: ±450PPM 100K~1M: 0~-700PPM 1.1M~10M: 0~-1500PPM | Temperature cycling 温度循环 | ΔR/R±(1%+0.05 Ω) |
| Short-time overload 短时间过负荷 | ΔR/R±(0.75%+0.05 Ω) | Humidity (steady State) 恒定湿热 | ΔR/R±(2%+0.05 Ω) |
| Terminal strength 端子强度 | No evidence of mechanical damage 无可见机械损伤 | Load life in humidity 湿度寿命 | 1/2W 1W 2W: ΔR/R±(3.0%+0.05Ω) 3W: ΔR/R±(5.0%+0.05Ω) |
| Soldering heat 耐焊接热 | ΔR/R±(1%+0.05 Ω) | Load life 负载寿命 | 1/2W 1W 2W: ΔR/R±(3.0%+0.05Ω) 3W: ΔR/R±(5.0%+0.05Ω) |
| Solderability 可焊性 | Min.95% coverage 最少 95% 覆盖率 | Insulation resistance 绝缘电阻 | ≥1,000MΩ |
| | | Resistance to solvent 耐溶剂 | No deterioration of protective coating and markings 封装层，色码完整 |

Ordering Procedure (Example: CPR 2W 5% 10K T/B)

订购方式 (例如: CPR 2W 5% 10K T/B)

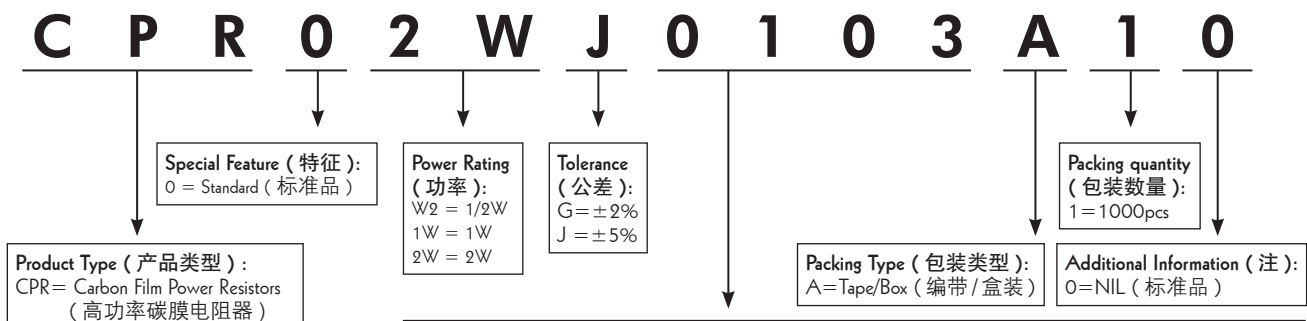

Resistance Value (阻值):
5% (E-24 series): The 1st digit is "0", the 2nd & 3rd digits are for the significant figures of the resistance and the 4th indicate the number of zeros following
 5% 产品 (E-24 系列阻值): 第 1 位是 0, 第 2、3 位表示阻值的有效数, 第 4 位表示有几个 0.
2% (E-24 series): The 1st digit is "0", the 2nd & 3rd digits are for the significant figures of the resistance and the 4th indicate the number of zeros following;
 2% 产品 (E-24 系列阻值): 第 1-3 位数表示阻值的有效数, 第 4 位数表示有几个 0

Feature (特性)

- High power in small body size 体积小功率高
- Excellent flame Retardant coating 优异不燃性涂装
- High stability even in bad environment 恶劣环境下同样稳定工作
- Match the Safety requirement 满足安全标准要求



Derating Curve (降功率曲线)

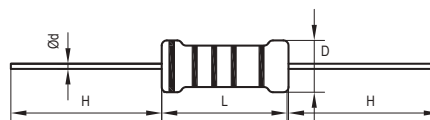

Specification (性能)

| Part No. 料号 | Type 类型 | Power rating 功率 70°C | Dimension (尺寸)(mm) | | | | Max. Working Voltage 最大工作电压 | Dielectric Withstanding Voltage 绝缘耐压 | Max. Overload Voltage 最大过负荷电压 | Resistance Range 阻值范围 |
|----------------|------------|----------------------------|--------------------|----------|--------|-----|--------------------------------|---|----------------------------------|--------------------------|
| | | | D | L | d±0.05 | H±3 | | | | |
| MPR01W | MPR-100 | 1W | 2.2±0.5 | 6.5±1.0 | 0.75 | 28 | 500V | 500V | 600V | 10Ω ~ 10M |
| MPR02W | MPR-200 | 2W | 3.5±0.5 | 9.5±1.0 | 0.75 | 28 | 500V | 500V | 1000V | 10Ω ~ 10M |
| MPR03W | MPR-300 | 3W | 5.0±0.5 | 15.5±1.0 | 0.75 | 28 | 750V | 500V | 1000V | 10Ω ~ 1M |

Performance Specifications (性能)

| | | |
|-------------------------|--------|--|
| Temperature coefficient | 温度系数 | 1W: ±200PPM/°C(±1%), ±250PPM/°C(±5%) 2W: ±200PPM/°C(±2%), ±250PPM/°C(±5%) 3W: ±50PPM/°C(±1%, ±5%) |
| Short-time overload | 短时间过负荷 | ΔR/R ≤ ±(2%+0.05Ω), with no evidence of mechanical damage (无可见机械损伤) |
| Terminal Strength | 端子强度 | with no evidence of mechanical damage (无可见机械损伤) |
| Soldering heat | 耐焊接热 | ΔR/R ≤ ±(1%+0.05Ω), with no evidence of mechanical damage (无可见机械损伤) |
| Solderability | 可焊性 | Min. 95% coverage (最少 95% 覆盖率) |
| Temperature cycling | 温度循环 | ΔR/R ≤ ±(2%+0.05Ω), with no evidence of mechanical damage (无可见机械损伤) |
| Load life in humidity | 湿度寿命 | ΔR/R ≤ ±(5%+0.05Ω), with no evidence of mechanical damage (无可见机械损伤) |
| Load life | 负载寿命 | 1W, 3W: ΔR/R ≤ ±(3%+0.05Ω), with no evidence of mechanical damage (无可见机械损伤) 2W: ΔR/R ≤ ±(5%+0.06Ω), with no evidence of mechanical damage (无可见机械损伤) |
| Flame retardant | 阻燃 | Resistor insulation is self-extinguishing within 10 seconds after externally applied flame is removed 火焰移开后 10 秒内, 电阻自动绝燃, 无可见火焰 |

Ordering Procedure (Example: MPR 1W 5% 100Ω T/B-5000)

订购方式 (例如: MPR 1W 5% 100Ω T/B-5000)

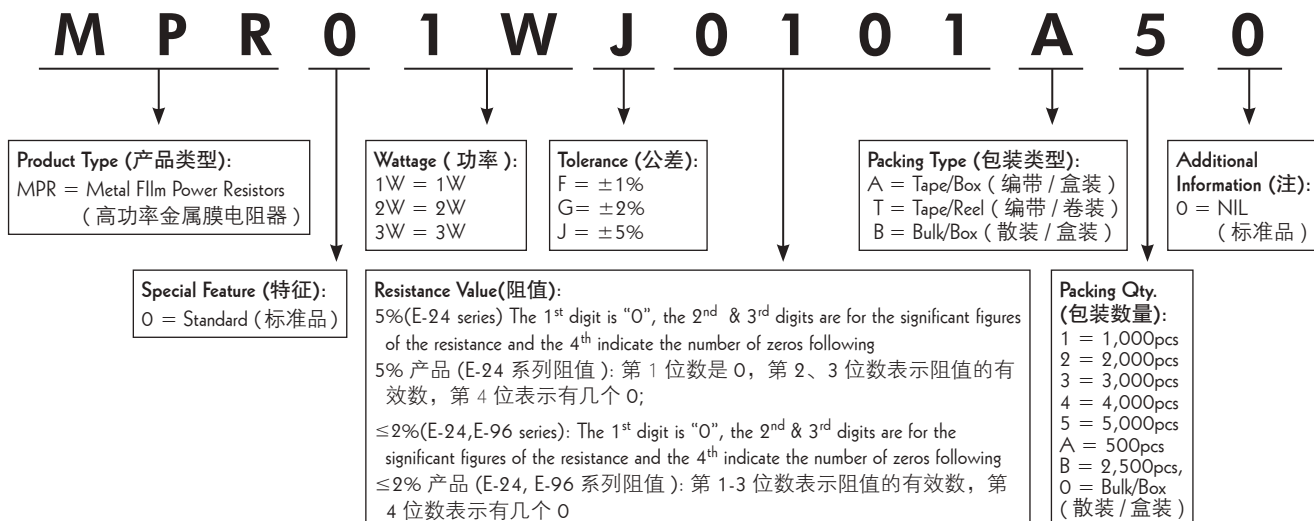

Feature (特性)

- Excellent flame retardant coating 优异不燃性涂装
- High Stability even in bad environment 恶劣环境下同样稳定工作
- High purity ceramic core 高纯度瓷芯
- Meet EIA-RC2655A requirements 满足EIA-RC2655A标准要求
- High safety standard 满足安全性标准要求



Derating Curve (降功率曲线)

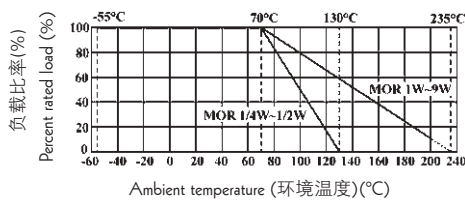

Heat Rise Chart (表面温升)

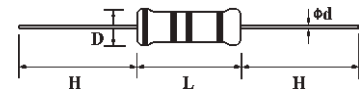
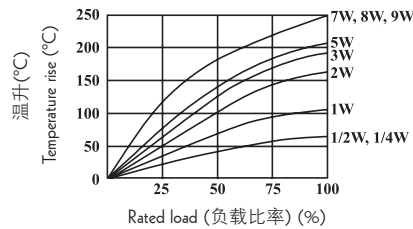

Specification (性能)

| Part No. 料号 | Type 类型 | Power Rating 功率 70°C | Dimension (尺寸) (mm) | | | | Max. Working Voltage 最大工作电压 | Max. Overload Voltage 最大过负荷电压 | Dielectric Withstanding Voltage 绝缘耐压 | Resistance Range 阻值范围 |
|--|------------|----------------------------|---------------------|----------|--------|-----|--------------------------------|----------------------------------|---|--------------------------|
| | | | D | L | d±0.05 | H±3 | | | | |
| Normal Size (正常尺寸) | | | | | | | | | | |
| MOR0W4 | MOR-25 | 1/4W | 2.2±0.5 | 6.5±1.0 | 0.54 | 28 | 250V | 400V | 250V | 0.1Ω ~ 470KΩ |
| MOR0W2 | MOR-50 | 1/2W | 3.0±0.5 | 9.5±1.0 | 0.54 | 28 | 250V | 400V | 250V | 0.1Ω ~ 560KΩ |
| MOR01W | MOR-100 | 1W | 4.0±0.5 | 11.5±1.0 | 0.65 | 28 | 350V | 600V | 350V | 0.1Ω ~ 560KΩ |
| MOR02W | MOR-200 | 2W | 5.0±0.5 | 15.5±1.0 | 0.70 | 28 | 350V | 600V | 350V | 0.1Ω ~ 560KΩ |
| MOR03W | MOR-300 | 3W | 6.0±0.5 | 17.5±1.0 | 0.75 | 28 | 500V | 800V | 500V | 0.1Ω ~ 560KΩ |
| MOR05W | MOR-500 | 5W | 8.0±0.5 | 24.5±1.0 | 0.75 | 38 | 750V | 1000V | 750V | 0.1Ω ~ 680KΩ |
| MOR07W | MOR-700 | 7W | 8.0±0.5 | 29.5±1.0 | 0.75 | 38 | 750V | 1000V | 750V | 20Ω ~ 150KΩ |
| MOR08W | MOR-800 | 8W | 8.0±0.5 | 39.5±1.0 | 0.75 | 38 | 750V | 1000V | 750V | 30Ω ~ 200KΩ |
| MOR09W | MOR-900 | 9W | 8.0±0.5 | 52.5±1.0 | 0.75 | 38 | 750V | 1000V | 750V | 50Ω ~ 200KΩ |
| Small Size & Extra Small Size (小型及超小型尺寸) | | | | | | | | | | |
| MOR0S2 | MOR-50-S | 1/2W | 2.2±0.5 | 6.5±1.0 | 0.54 | 28 | 250V | 400V | 250V | 0.1Ω ~ 470KΩ |
| MOR01S | MOR-100-S | 1W | 3.5±0.5 | 9.5±1.0 | 0.65 | 28 | 350V | 600V | 350V | 0.1Ω ~ 560KΩ |
| MOR02S | MOR-200-S | 2W | 4.5±0.5 | 11.5±1.0 | 0.65 | 28 | 350V | 600V | 350V | 0.1Ω ~ 560KΩ |
| MOR03S | MOR-300-S | 3W | 5.0±0.5 | 15.5±1.0 | 0.70 | 28 | 350V | 600V | 350V | 0.1Ω ~ 560KΩ |
| MOR05U | MOR-500-SS | 5W | 6.0±0.5 | 17.5±1.0 | 0.75 | 28 | 500V | 800V | 500V | 0.1Ω ~ 560KΩ |
| MOR05S | MOR-500-S | 5W | 8.0±0.5 | 24.5±1.0 | 0.75 | 38 | 500V | 800V | 500V | 0.1Ω ~ 680KΩ |

- Standard E-24 series value in ± 5% tolerance (标准E-24系列 ± 5%公差阻值)
- Standard Gray base color for Normal Size product, Blue color for Small Size product (正常尺寸产品涂灰色底漆, 小尺寸产品涂海蓝色底漆)
- Standard Non-Flammable coating (标准不燃性涂装)
- Non-Inductive type available on a case to case basis (无感, 可特别生产)

Performance Specification

| | |
|--|---|
| Temperature coefficient 温度系数 | 1/4W, 1/2WS: $\leq 100\text{K}\Omega: \pm 350\text{PPM}/^\circ\text{C}$ / $100\text{K}\Omega < R \leq 470\text{K}\Omega: 0 \sim -700\text{PPM}/^\circ\text{C}$ 1/2W, 1WS: $\leq 120\text{K}\Omega: \pm 350\text{PPM}/^\circ\text{C}$ / $120\text{K}\Omega < R \leq 560\text{K}\Omega: 0 \sim -700\text{PPM}/^\circ\text{C}$ 1W, 2W, 2WS, 3W, 3WS, 5WSS: $\leq 150\text{K}\Omega: \pm 350\text{PPM}/^\circ\text{C}$ / $150\text{K}\Omega < R \leq 560\text{K}\Omega: 0 \sim -700\text{PPM}/^\circ\text{C}$ 5W, 5WS: $\leq 180\text{K}\Omega: \pm 350\text{PPM}/^\circ\text{C}$ / $180\text{K}\Omega < R \leq 680\text{K}\Omega: 0 \sim -700\text{PPM}/^\circ\text{C}$ 7W, 8W, 9W: $\pm 350\text{PPM}/^\circ\text{C}$ |
| Short-time overload 短时间过负荷 | Normal size (正常尺寸), $\Delta R/R \leq \pm(1\%+0.05\Omega)$, with no evidence of mechanical damage (无可见机械损伤) Small size (小尺寸), $\Delta R/R \leq \pm(2\%+0.05\Omega)$, with no evidence of mechanical damage (无可见机械损伤) |
| Dielectric withstanding voltage 绝缘耐压 | No evidence of flashover, mechanical damage, arcing or insulation breakdown (无击穿、飞弧及可见机械损伤) |
| Pulse overload 脉冲过负荷 | Normal size (正常尺寸), $\Delta R/R \leq \pm(2\%+0.05\Omega)$, with no evidence of mechanical damage (无可见机械损伤) Small size (小尺寸), $\Delta R/R \leq \pm(5\%+0.05\Omega)$, with no evidence of mechanical damage (无可见机械损伤) |
| Terminal Strength 端子强度 | No evidence of mechanical damage (无可见机械损伤) |
| Soldering heat 耐焊接热 | $\Delta R/R \leq \pm(1\%+0.05\Omega)$ with no evidence of mechanical damage (无可见机械损伤) |
| Solderability 可焊性 | Min. 95% coverage (最少 95% 覆盖率) |
| Resistance to solvent 耐溶剂 | No deterioration of protective coating and markings (包封层, 色码完整) |
| Temperature cycling 温度循环 | $\Delta R/R \leq \pm(2\%+0.05\Omega)$ with no evidence of mechanical damage (无可见机械损伤) |
| Humidity (Steady State) 恒定湿热 | $\Delta R/R \leq \pm(2\%+0.05\Omega)$ with no evidence of mechanical damage (无可见机械损伤) |
| Load life in humidity 湿度寿命 | $\Delta R/R: \leq \pm 5\%$ for $< 100\text{K}\Omega$; $\pm 10\%$ for $\geq 100\text{K}\Omega$. |
| Load life 负载寿命 | $\Delta R/R: \leq \pm 5\%$ for $< 100\text{K}\Omega$; $\pm 10\%$ for $\geq 100\text{K}\Omega$. |
| Flame retardant 阻燃 | Resistor insulation is self-extinguishing within 10 seconds after externally applied flame is removed (火焰移开后 10 秒内, 电阻自动绝燃, 无可见火焰) |

Ordering Procedure (Example: MOR 1W-S 5% 8.2K J/B-1000)

订购方式 (例如: MOR 1W-S 5% 8.2K J/B-1000)

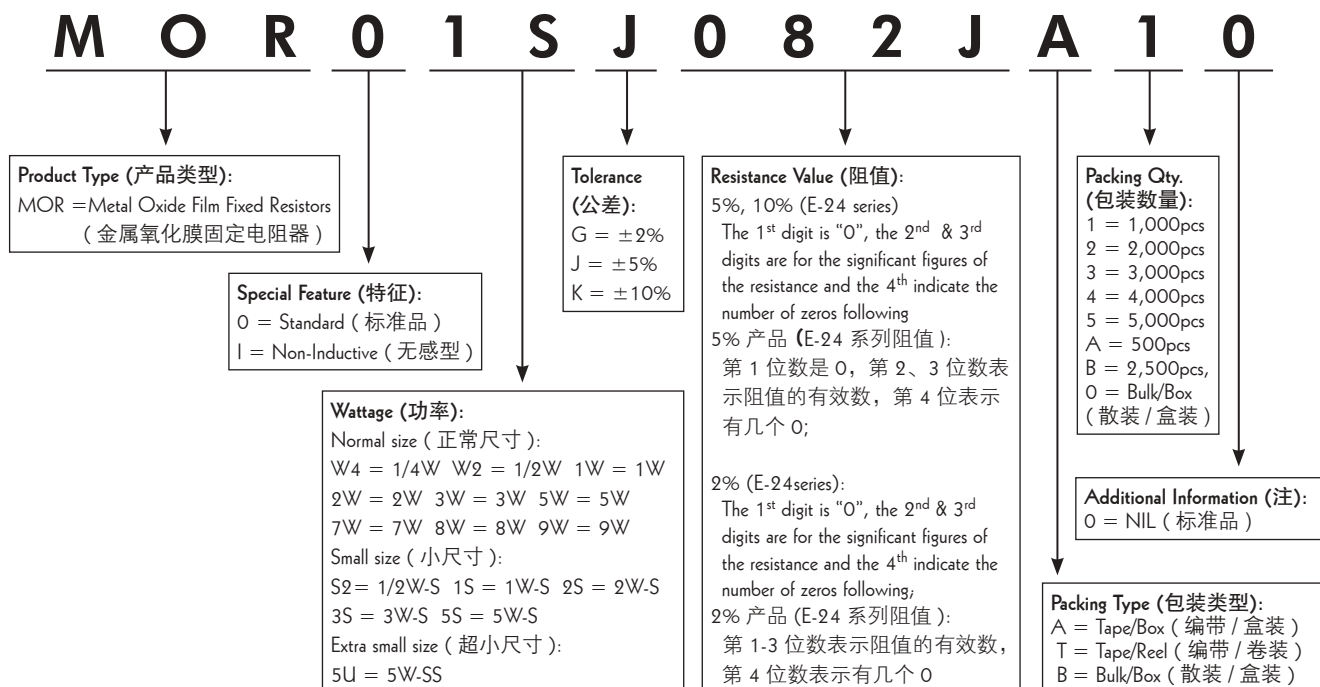

Feature (特性)

- Excellent flame retardant coating 优异不燃性涂装
- Too low or too high ohmic value can be supplied on a case to case basis
超低或超高阻值都可特别提供
- Non-Inductive type available 可特别提供无感型产品

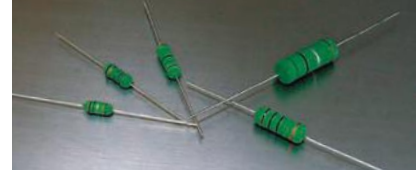

KNP Type (KNP型)



KNS Type (KNS型)

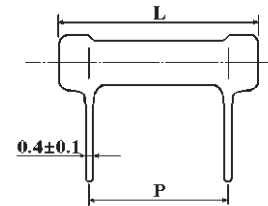
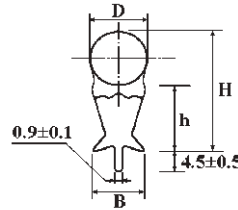

| Part No. 料号 | Type 类型 | Power Rating 功率 70°C | Dimension (尺寸)(mm) | | | | | | Resistance Range 阻值范围 |
|----------------|------------|----------------------------|--------------------|---------|-------|-------|-------|---------|--------------------------|
| | | | D ± 1.0 | L ± 1.5 | P ± 1 | H ± 1 | h ± 1 | B ± 0.5 | |
| KNS02W | KNS-200 | 2W | 7.0 | 19.0 | 8 | 19 | 12 | 4.5 | 0.05Ω ~ 470Ω |
| KNS03W | KNS-300 | 3W | 7.0 | 21.0 | 10 | 19 | 13 | 4.5 | 0.068Ω ~ 470Ω |
| KNS05W | KNS-500 | 5W | 9.0 | 26.0 | 15 | 21.5 | 13 | 6.5 | 0.01Ω ~ 750Ω |
| KNS07W | KNS-700 | 7W | 9.0 | 31.0 | 20 | 21.5 | 13 | 6.5 | 0.1Ω ~ 1.1KΩ |
| KNS08W | KNS-800 | 8W | 9.0 | 41.0 | 30 | 21.5 | 13 | 6.5 | 0.2Ω ~ 2.2KΩ |
| KNS0AW | KNS-1000 | 10W | 9.0 | 54.0 | 43 | 21.5 | 13 | 6.5 | 0.3Ω ~ 3.3KΩ |

| Part No. 料号 | Type 类型 | Power Rating 功率 70°C | Dimension (尺寸)(mm) | | | | Resistance Range 阻值范围 |
|---------------------------|------------|----------------------------|--------------------|-------|----------|-------|--------------------------|
| | | | D ± 1 | L ± 1 | d ± 0.05 | H ± 3 | |
| Normal Size (正常尺寸) | | | | | | | |
| KNP0W2 | KNP-50 | 1/2W | 3.5 | 9.5 | 0.60 | 28 | 0.01Ω ~ 820Ω |
| KNP01W | KNP-100 | 1W | 4.5 | 11.5 | 0.65 | 28 | 0.01Ω ~ 1.2KΩ |
| KNP02W | KNP-200 | 2W | 5.5 | 15.5 | 0.70 | 28 | 0.01Ω ~ 3.0KΩ |
| KNP03W | KNP-300 | 3W | 6.5 | 17.5 | 0.75 | 28 | 0.039Ω ~ 3.9KΩ |
| KNP05W | KNP-500 | 5W | 8.5 | 24.5 | 0.75 | 38 | 0.082Ω ~ 5.6KΩ |
| KNP07W | KNP-700 | 7W | 8.5 | 29.5 | 0.75 | 38 | 0.1Ω ~ 8.2KΩ |
| KNP08W | KNP-800 | 8W | 8.5 | 39.5 | 0.75 | 38 | 0.15Ω ~ 12KΩ |
| KNP09W | KNP-900 | 9W | 8.5 | 52.5 | 0.75 | 38 | 0.22Ω ~ 15KΩ |
| Small Size (小型化尺寸) | | | | | | | |
| KNP01S | KNP-100-S | 1W | 4.0 | 9.5 | 0.60 | 28 | 0.01Ω ~ 820Ω |
| KNP02S | KNP-200-S | 2W | 4.5 | 11.5 | 0.65 | 28 | 0.01Ω ~ 1.2KΩ |
| KNP03S | KNP-300-S | 3W | 5.5 | 15.5 | 0.70 | 28 | 0.01Ω ~ 3.0KΩ |
| KNP05S | KNP-500-S | 5W | 6.5 | 17.5 | 0.75 | 28 | 0.039Ω ~ 3.9KΩ |
| KNP07S | KNP-700-S | 7W | 8.5 | 24.5 | 0.75 | 38 | 0.082Ω ~ 5.6KΩ |
| KNP08S | KNP-800-S | 8W | 8.5 | 29.5 | 0.75 | 38 | 0.1Ω ~ 8.2KΩ |
| KNP09S | KNP-900-S | 9W | 8.5 | 39.5 | 0.75 | 38 | 0.15Ω ~ 12KΩ |
| KNP0AS | KNP-1000-S | 10W | 8.5 | 52.5 | 0.75 | 38 | 0.22Ω ~ 15KΩ |

KNH Type (KNH型)



Derating Curve (降功率曲线)

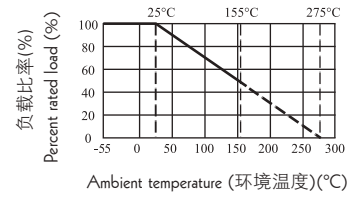

| Part No. 料号 | Type 类型 | Power Rating 功率 70°C | Dimension (尺寸)(mm) | | | | Resistance Range 阻值范围 |
|----------------|------------|----------------------------|--------------------|---------|-------|-------|--------------------------|
| | | | A ± 1.5 | B ± 1.5 | C ± 3 | D ± 1 | |
| KNH020 | KNH-20W | 20W | 19 | 50 | 19 | 5 | 0.4Ω ~ 1KΩ |
| KNH025 | KNH-25W | 25W | 19 | 60 | 19 | 5 | 0.4Ω ~ 1KΩ |
| KNH030 | KNH-30W | 30W | 19 | 75 | 19 | 5 | 0.5Ω ~ 3KΩ |
| KNH040 | KNH-40W | 40W | 19 | 90 | 19 | 5 | 0.6Ω ~ 5KΩ |
| KNH050 | KNH-50W | 50W | 31 | 75 | 31 | 8 | 3Ω ~ 10KΩ |
| KNH060 | KNH-60W | 60W | 31 | 90 | 31 | 8 | 3Ω ~ 15KΩ |
| KNH080 | KNH-80W | 80W | 31 | 115 | 31 | 8 | 3Ω ~ 20KΩ |
| KNH 100 | KNH-100W | 100W | 31 | 140 | 31 | 8 | 3Ω ~ 30KΩ |

Performance Specification (性能)

| | | |
|-------------------------|--------|---|
| Temperature coefficient | 温度系数 | ≥20Ω: ±300PPM/°C, <20Ω: ±400PPM/°C |
| Short-time overload | 短时间过负荷 | ΔR/R ≤ ±(2%+0.05Ω), with no evidence of mechanical damage (无可见机械损伤) |
| Terminal strength | 端子强度 | No evidence of mechanical damage (无可见机械损伤) |
| Soldering heat | 耐焊接热 | ΔR/R ≤ ±(1%+0.05Ω), with no evidence of mechanical damage (无可见机械损伤) |
| Solderability | 可焊性 | Min. 95% coverage (最少 95% 覆盖率) |
| Load life in humidity | 湿度寿命 | ΔR/R ≤ ±(5%+0.05Ω), with no evidence of mechanical damage (无可见机械损伤) |
| Load life | 负载寿命 | ΔR/R ≤ ±(5%+0.05Ω), with no evidence of mechanical damage (无可见机械损伤) |

Ordering Procedure (Example: KNP 3W-S 5% 12Ω T/B-1000)

订购方式 (例如: KNP 3W-S 5% 12Ω T/B-1000)

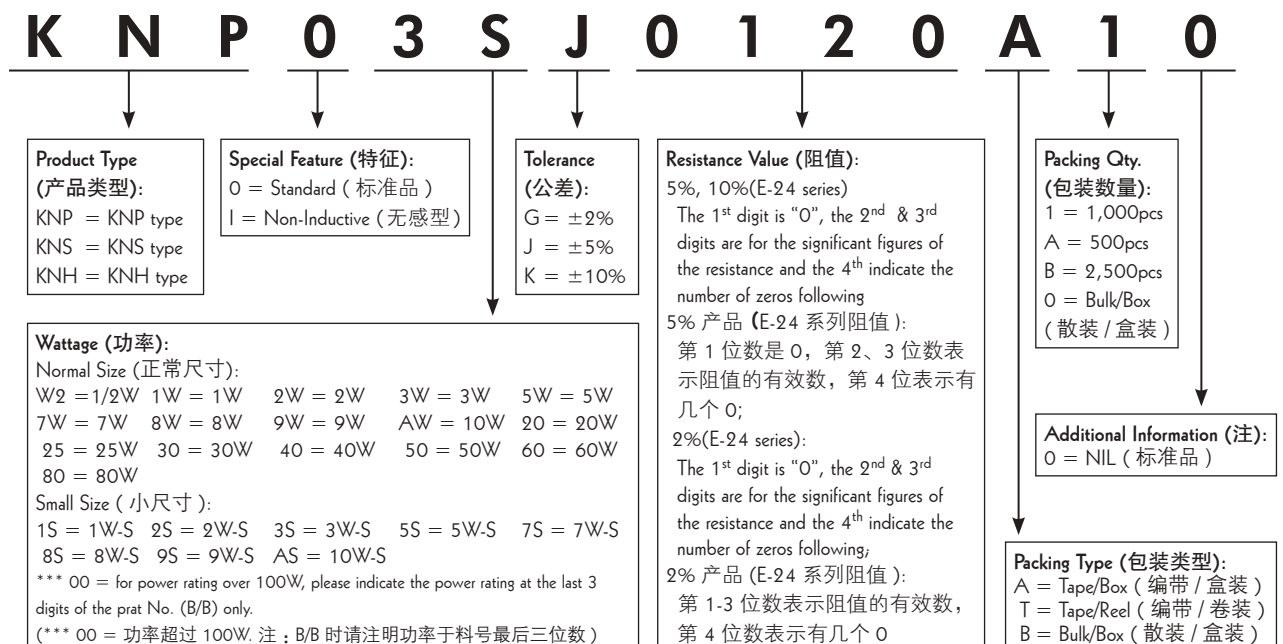

Feature (特性)

- Excellent flame retardant coating (优异不燃性涂装)
- According to IEC 61000-4-5 (符合 IEC61000-4-5 标准)
- Applies to electricity meters, appliances and ballast (适用于电表、家电及镇流器产品)



Dimension (mm)

尺寸 (mm)



Derating Curve

降功率曲线

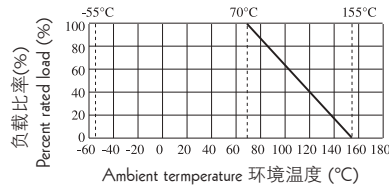

1.2/50μS Pulse Withstanding Curve

1.2/50μS脉冲曲线

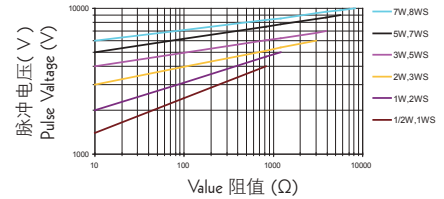

Specification (性能)

| Part No. 料号 | Type 类型 | Dimension (尺寸) (mm) | | | | Resistance Range 阻值范围 |
|----------------|--------------------|---------------------|------|--------|-----|--------------------------|
| | | D±1 | L ±1 | d±0.05 | H±3 | |
| KSR 0W2, 01S | KSR-50, KSR-100-S | 4.5 | 9.5 | 0.65 | 28 | 10Ω~820Ω |
| KSR 01W, 02S | KSR-100, KSR-200-S | 5.0 | 11.5 | 0.65 | 28 | 10Ω~1.2KΩ |
| KSR 02W, 03S | KSR-200, KSR-300-S | 5.5 | 15.5 | 0.75 | 28 | 10Ω~3.0KΩ |
| KSR 03W, 05S | KSR-300, KSR-500-S | 6.5 | 17.5 | 0.75 | 28 | 10Ω~3.9KΩ |
| KSR05W, 07S | KSR-500, KSR-700-S | 8.5 | 24.5 | 0.75 | 38 | 10Ω~5.6KΩ |
| KSR07W, 08S | KSR-700, KSR-800-S | 8.5 | 29.5 | 0.75 | 38 | 10Ω~8.2KΩ |

Specification (性能)

| | | |
|------------------------------|--------|--|
| Temperature coefficient | 温度系数 | ±200PPM |
| Short-time Overload | 短时间过负荷 | ΔR/R±(5%+0.05Ω) |
| Terminal strength | 端子强度 | no evidence of mechanical damage (无可见机械损伤) |
| Resistance to soldering heat | 耐焊接热 | ΔR/R±(1%+0.05Ω) |
| Solderability | 可焊性 | Min.95% coverage (最少 95% 覆盖率) |
| Temperature cycling | 温度循环 | ΔR/R±(2%+0.05Ω) |
| Humidity (Steady State) | 恒定湿热 | ΔR/R±(2%+0.05Ω) |
| Load life in humidity | 湿度寿命 | ΔR/R±(5%+0.05Ω) |
| Load life | 负载寿命 | ΔR/R±(5%+0.05Ω) |
| Resistance to solvent | 耐溶剂 | no evidence of mechanical damage (无可见机械损伤) |

Ordering Procedure (Example: KSR 1/2W 5% 820Ω T/B-1000)

订购方式 (例如: KSR 1/2W 5% 820Ω T/B-1000)

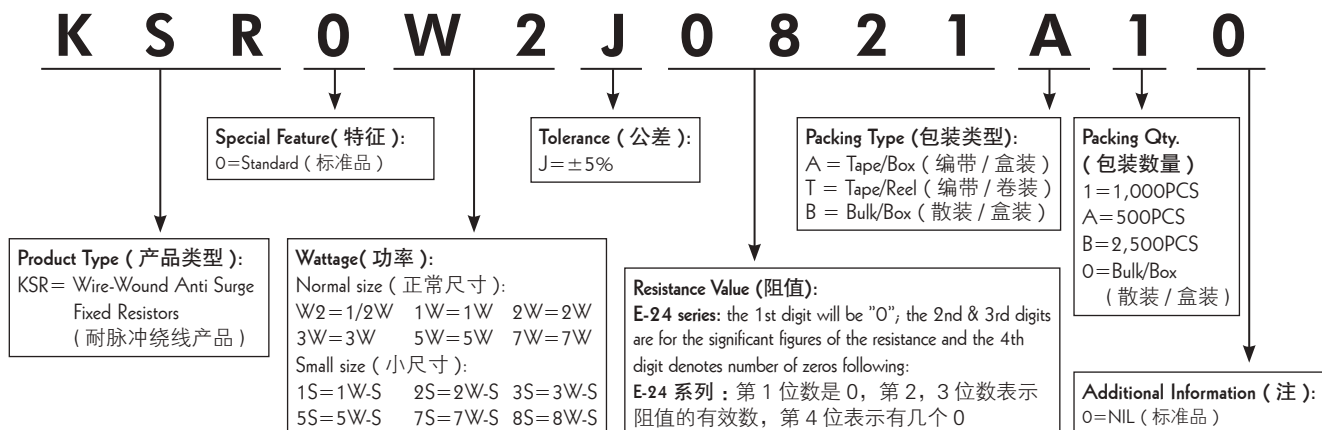

Feature (特性)

- Small body size 体积小
- High power 功率大
- Excellent flame retardant coating 优异的阻燃封装
- Provides stable performance in various environments 在各种环境中提供优异的稳定性的



Derating Curve (降功率曲线)

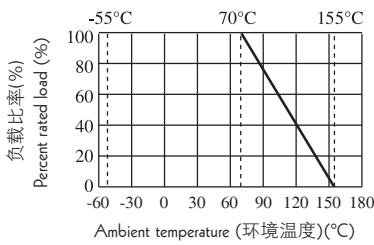

Dimension (尺寸) (mm)

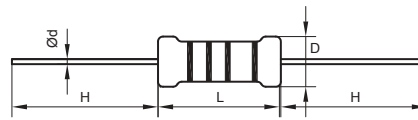

Surge Withstanding Curve (脉冲曲线)

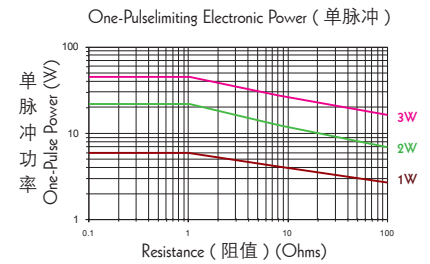

| Part No. 料号 | Type 类型 | Power Rating 功率 70°C | Dimension (尺寸)(mm) | | | | Max. Working Voltage 最大工作电压 | Dielectric Withstanding Voltage 绝缘耐压 | Resistance Range 阻值范围 |
|----------------|------------|----------------------------|--------------------|------|--------|-----|--------------------------------|---|--------------------------|
| | | | D±1 | L±1 | d±0.05 | H±3 | | | |
| WPRO1W | WPR-100 | 1W | 2.5 | 6.2 | 0.60 | 28 | 50V | 250V | 0.1Ω~300Ω |
| WPRO2W | WPR-200 | 2W | 3.5 | 9.0 | 0.80 | 28 | 50V | 250V | 0.1Ω~1KΩ |
| WPRO3W | WPR-300 | 3W | 4.5 | 10.5 | 0.80 | 28 | 50V | 350V | 0.1Ω~1KΩ |

Performance Specification (性能)

| | |
|---------------------------------|---|
| Temperature coefficient 温度系数 | ±200PPM/°C |
| Short-time overload 短时间过负荷 | $\Delta R/R \leq \pm(5.0\% + 0.05\Omega)$ with no evidence of mechanical damage (无可见机械损伤) |
| Terminal strength 端子强度 | No evidence of mechanical damage (无可见机械损伤) |
| Solderability 可焊性 | Min. 95% coverage (最少 95% 覆盖率) |
| Soldering heat 耐焊接热 | $\Delta R/R \leq \pm(1.0\% + 0.05\Omega)$ |
| Insulation resistance 绝缘电阻 | $\geq 1,000 \text{ M}\Omega$ |
| Temperature cycling 温度循环 | $\Delta R/R \leq \pm(2.0\% + 0.05\Omega)$ |
| Resistance to solvent 耐溶剂 | No deterioration of protective coating and markings (包封层, 色码完整) |
| Humidity (steady State) 恒定湿热 | $\Delta R/R \leq \pm(2.0\% + 0.05\Omega)$ with no evidence of mechanical damage (无可见机械损伤) |
| Load life 负载寿命 | $\Delta R/R \leq \pm(5.0\% + 0.05\Omega)$ |
| Load life in humidity 湿度寿命 | $\Delta R/R \leq \pm(5.0\% + 0.05\Omega)$ |
| Pulse test 脉冲测试 | $\Delta R/R \leq \pm(5.0\% + 0.05\Omega)$ |

Feature (特性)

- Ideal circuit opening controller, disconnecting units from overload rating specified 理想的电流过负荷保护元件
- Too low or too high ohmic value can be supplied on a case to case basis 超高或超低阻值也能特别生产

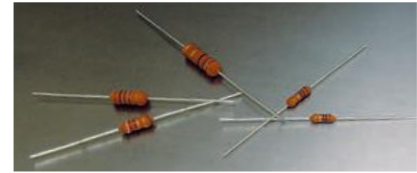

Fusing Characteristics (熔断特性)

| Resistance Value (阻值) | Test Wattage (测试功率) | Fusing Time (熔断时间) |
|--------------------------|--------------------------|-----------------------|
| ≤ 2.2Ω | 32 X Power Rating (额定功率) | ≤ 60 seconds (秒) |
| > 2.2Ω | 16 X Power Rating (额定功率) | ≤ 60 seconds (秒) |

The fusing test current or voltage should be stable, change within 5%. (测试电流或电压必须稳定变化率不超过 5%)

Derating Curve (降功率曲线)



Specification (性能)

| Part No. 料号 | Type 类型 | Power Rating 功率 70°C | Dimension (尺寸)(mm) | | | | Dielectric Withstanding Voltage 绝缘耐压 | Resistance Range 阻值范围 |
|----------------|------------|----------------------------|--------------------|-------|--------|-----|--|-----------------------------|
| | | | D±0.5 | L±1.0 | d±0.05 | H±3 | | |
| FRN0W4 | FRN-25 | 1/4W | 2.2 | 6.5 | 0.54 | 28 | 300V | 0.22Ω ~ 10KΩ |
| FRN0W2 | FRN-50 | 1/2W | 3.0 | 9.0 | 0.54 | 28 | 350V | 0.22Ω ~ 10KΩ |
| FRN01W | FRN-100 | 1W | 3.5 | 9.5 | 0.65 | 28 | 350V | 0.22Ω ~ 10KΩ |
| FRN02W | FRN-200 | 2W | 4.5 | 11.5 | 0.65 | 28 | 600V | 0.22Ω ~ 10KΩ |
| FRN03W | FRN-300 | 3W | 5.0 | 15.5 | 0.70 | 28 | 600V | 0.22Ω ~ 10KΩ |

Performance Specification (性能)

| | |
|---|---|
| Temperature coefficient 温度系数 | ± 350PPM / °C |
| Short-time overload 短时间过负荷 | ΔR/R ≤ ±(2%+0.05Ω) with no evidence of mechanical damage (无可见机械损伤) |
| Dielectric withstanding voltage 绝缘耐压 | No evidence of flashover, mechanical damage, arcing or insulation breakdown (无击穿、飞弧及可见机械损伤) |
| Terminal strength 端子强度 | No evidence of mechanical damage (无可见机械损伤) |
| Soldering heat 耐焊接热 | ΔR/R ≤ ±(1%+0.05Ω) with no evidence of mechanical damage (无可见机械损伤) |
| Solderability 可焊性 | Min. 95% coverage (最少 95% 覆盖率) |
| Temperature cycling 温度循环 | ΔR/R ≤ ±(2%+0.05Ω) with no evidence of mechanical damage (无可见机械损伤) |
| Load life in humidity 湿度寿命 | ΔR/R ≤ ±(5%+0.05Ω) with no evidence of mechanical damage (无可见机械损伤) |
| Load life 负载寿命 | ΔR/R ≤ ±(5%+0.05Ω) with no evidence of mechanical damage (无可见机械损伤) |
| Flame retardant 阻燃 | Not have any specimens which burn with flaming combustion after each application of the test flame (无可见燃烧或飞弧) |

Ordering Procedure (Example: FRN 1W 5% 1Ω T/B-1000)

订购方式 (例如: FRN 1W 5% 1Ω T/B-1000)

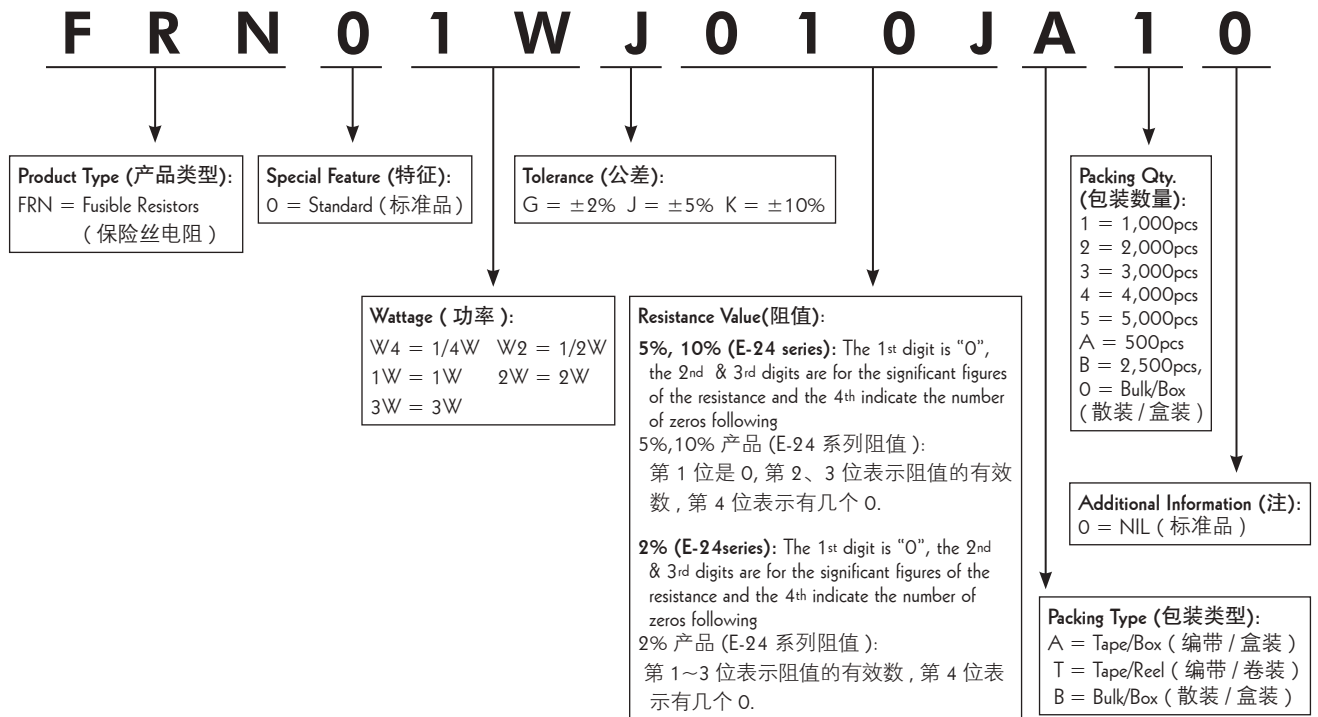

Feature (特性)

1. Suitable for all kinds of protection circuit
适用各种保护电路
2. Non-flammable coating, could withstand High Temperature
优异不燃性涂装，耐高温
3. Common resistor with additional safety function, no flame or smoke, no explosion or coating crack when fusing
常见的电阻器具有额外的安全性能，无火焰或烟，无爆炸或涂层裂纹

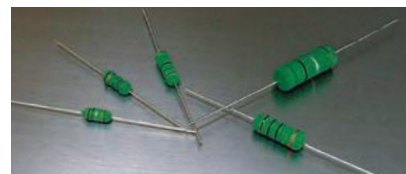
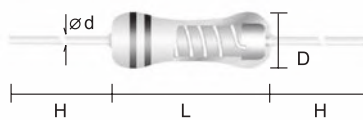

Specification (性能)

| Part No. 料号 | Type 类型 | Dimension (尺寸)(mm) | | | | Tolerance 公差 | Resistance Range 阻值范围 |
|----------------|------------|--------------------|--------|--------|-----|-----------------|--------------------------|
| | | D ±1.0 | L ±1.0 | d±0.05 | H±3 | | |
| KFR01W | KFR-100 | 3.5 | 9.5 | 0.55 | 28 | ±5% | 4.7Ω~47Ω |
| KFR02W | KFR-200 | 4.5 | 11.5 | 0.65 | 28 | | |
| KFR03W | KFR-300 | 5.5 | 15.5 | 0.75 | 28 | | |
| KFR05W | KFR-500 | 6.5 | 17.5 | 0.75 | 28 | | |
| KFR07W | KFR-700 | 8.5 | 24.5 | 0.75 | 38 | | |

Fusing Characteristics (熔断特性)

Fusing time could be designed according to customer's circuit Spec.

The following are necessary information must be provided for any Fusing time Spec. request:

1. Working ambient temperature & Working voltage
2. The Rated Power or Current
3. Requested Fusing Power or Current
4. Resistance Value & Tolerance
5. The requirement of the Resistor Body Size
6. The Wave of Voltage & the Frequency
7. Other general condition in circuit

熔断时间可根据客户的电路要求设计

为满足客户的特殊熔断性能要求，以下条件必须提供：

1. 工作环境温度和工作电压
2. 额定功率和电流
3. 熔断功率和电流
4. 阻值和公差
5. 电阻本体可允许的最小或最大尺寸 (如有要求时)
6. 电压的波动及中心测量频率
7. 有关电路的其它信息

Performance Specification (性能)

| | | |
|---------------------------------|--------|---|
| Temperature coefficient | 温度系数 | ±300PPM/°C |
| Short-time overload | 短时间过负荷 | ΔR/R ≤ ±(5%±0.05Ω), with no evidence of mechanical damage (无可见机械损伤) |
| Dielectric withstanding voltage | 绝缘耐压 | No evidence of flashover, mechanical damage.(500V). [无击穿、飞弧及可见机械损伤(500V)] |
| Terminal strength | 端子强度 | No evidence of mechanical damage (无可见机械损伤) |
| Soldering heat | 耐焊接热 | ΔR/R ≤ ±(1%±0.05Ω), with no evidence of mechanical damage (无可见机械损伤) |
| Solderability | 可焊性 | Min. 95% coverage (最小95%覆盖率) |
| Load life in humidity | 湿度寿命 | ΔR/R ≤ ±(5%±0.05Ω), with no evidence of mechanical damage (无可见机械损伤) |
| Load life | 负载寿命 | ΔR/R ≤ ±(5%±0.05Ω), with no evidence of mechanical damage (无可见机械损伤) |

Ordering Procedure (Example: KFR 1W 5% 10Ω T/B-1000)

订购方式 (例如: KFR 1W 5% 10Ω T/B-1000)

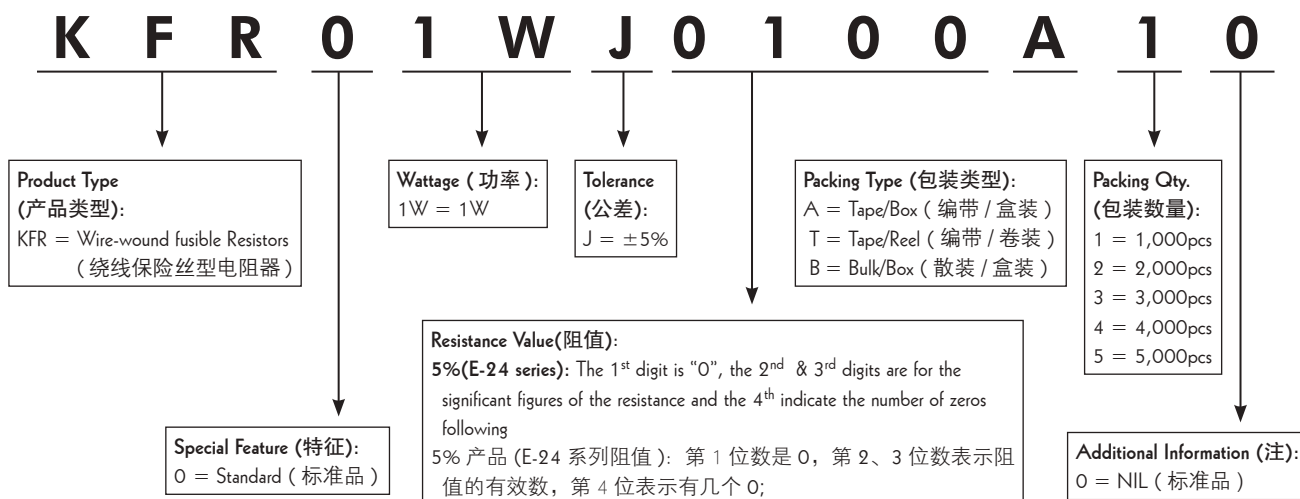

Dimension (尺寸) (mm)

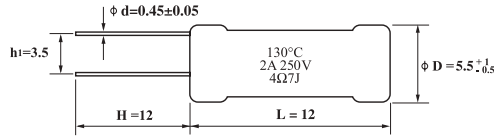

Derating Curve (降功率曲线)



| Type 类型 | Power Rating 功率 70°C | Tolerance 公差 | Resistance Value 阻值 | Fusing Temperature 额定熔断温度 T _F (C) | Holding Temperature 保持温度 T _H / T _C (C) | Max. Temperature 极限温度 T _M (C) | Rated Current 额定电流 I _r (A) | Rated Voltage 额定电压 U _r (V) |
|------------|----------------------------|-----------------|------------------------|--|--|--|---|---|
| TFR | 1W | ±5% | 4Ω7 | 130 | 102 | 180 | 2 | 250 |

Performance Specification (性能)

| | |
|---|---|
| Temperature coefficient 温度系数 | ± 400 PPM/°C |
| Short-time overload 短时间过负荷 | ΔR/R ≤ ±(2%+0.05Ω), with no evidence of mechanical damage (无可见机械损伤) |
| Insulation resistance 绝缘阻值 | ≥ 20,000MΩ |
| Dielectric withstanding voltage 绝缘耐压 | No evidence of flashover, mechanical damage, arcing or insulation breakdown (无击穿、飞弧及可见机械损伤) |
| Terminal strength 端子强度 | No evidence of mechanical damage (无可见机械损伤) |
| Humidity (Steady State) 恒定湿热 | ΔR/R ≤ ±(3%+0.05Ω), with no evidence of mechanical damage (无可见机械损伤) |
| Load life in humidity 湿度寿命 | ΔR/R ≤ ±(5%+0.05Ω), with no evidence of mechanical damage (无可见机械损伤) |
| Load life 负载寿命 | ΔR/R ≤ ±(5%+0.05Ω), with no evidence of mechanical damage (无可见机械损伤) |

Feature (特性)

- Made by Cu/Ni or Mn/Cu Alloy resistance wire materials 由铜/镍或锰/铜合金电阻线制成
- Excellent Solderability 优越的焊接性能
- Suitable for all kinds of Current sense application 适用于各种类型的电流感应器应用
- Application: Power Supply 电源供应器



| Type 规格 | CSRA CSRB CSRC CSRI CSRH | | | | | | | | | | | | | | | |
|---------------------------|--|--------------|--------------|-------------|------------|------------|------------|------------|------------|------------|------------|------------|------------|------------|------------|-----------|
| Ød mm 线径 | 0.4 | 0.5 | 0.6 | 0.7 | 0.8 | 0.9 | 1.0 | 1.1 | 1.2 | 1.3 | 1.4 | 1.5 | 1.6 | 1.8 | 2.0 | 2.3 |
| Rated Current 额定电流 | 2.0A | 2.5A | 3.0A | 4.0A | 4.5A | 5.0A | 5.5A | 6.0A | 7.0A | 7.5A | 8.0A | 9.0A | 9.5A | 11A | 12A | 14A |
| TCR 温度系数 | ±100PPM | | | | | | | | | | | | | | | |
| Resistance Range 阻值范围 ±5% | 80mΩ - 200mΩ | 60mΩ - 150mΩ | 60mΩ - 100mΩ | 35mΩ - 60mΩ | 5mΩ - 50mΩ | 5mΩ - 40mΩ | 3mΩ - 30mΩ | 3mΩ - 20mΩ | 3mΩ - 20mΩ | 3mΩ - 20mΩ | 3mΩ - 20mΩ | 3mΩ - 20mΩ | 3mΩ - 15mΩ | 3mΩ - 10mΩ | 3mΩ - 10mΩ | 3mΩ - 7mΩ |
| Remark 备注 | Diameter according to this table listed, P & H could be design by customer's requirement. 线径如本表所示, P值和H值可根据客户的要求进行设计 | | | | | | | | | | | | | | | |

CSRD (Flat Wire Type) (扁线型)

| Type 规格 | Rated Power 额定功率 | H max (mm) H 最大 (mm) | P max (mm) P 最大 (mm) | TCR 温度系数 | Resistance Range 阻值范围 ±1%, ±5% |
|---------|------------------|----------------------|----------------------|----------|--------------------------------|
| CSRD | 1W | 11 | 5 | ±20PPM | 5mΩ - 10mΩ |
| | 3W | 25 | 15 | | 5mΩ - 10mΩ |
| | 5W | 25 | 20 | | 5mΩ - 10mΩ |

Ordering Procedure (Example: CSRC15J045MB00)

订购方式 (例如: CSRC15J045MB00)

C S R C 1 5 J 0 4 5 M B 0 0

Type (类型):
 CSRA = A type
 CSRB = B type
 CSRC = C type
 CSRD = D type
 CSRE = E type
 CSRI = I type
 CSRH = H type

Wire Ø (线径 Ø):
 08=Ø0.8 10=Ø1.0
 12=Ø1.2 15=Ø1.5
 16=Ø1.6 20=Ø2.0
 23=Ø2.3

Tolerance (公差):
 G = ±2%
 J = ±5%
 K = ±10%

Resistance Value (阻值):
 5%, 10% (E-24 series)
 The 1st digit is "0", the 2nd & 3rd digits are for the significant figures of the resistance and the 4th indicate the number of zeros following
 5%、10% 产品 (E-24 系列阻值): 第 1 位是 0, 第 2、3 位表示阻值的有效数, 第 4 位表示有几个 0.
 2%(E-24 series):
 The 1st digit is "0", the 2nd & 3rd digits are for the significant figures of the resistance and the 4th indicate the number of zeros following
 2% 产品 (E-24 系列阻值): 第 1-3 位表示阻的有效数, 第 4 位表示有几个 0.

Packing Qty. (包装数量):
 0=B/B (散装)

Additional Information (注):
 0 = NIL (标准品)

Packing Type (包装类型):
 B = Bulk/Box (散装 / 盒装)

Feature (特性)

- Made of copper / nickel or manganese / copper alloy resistance wire (由铜 / 镍或锰 / 铜合金电阻线制成)
- Superior welding performance (优越的焊接性能)
- Applies to all types of current sensor applications (适用于各种类型的电流传感器应用)
- Power Supply (电源供应器)



Dimension (尺寸)(mm)

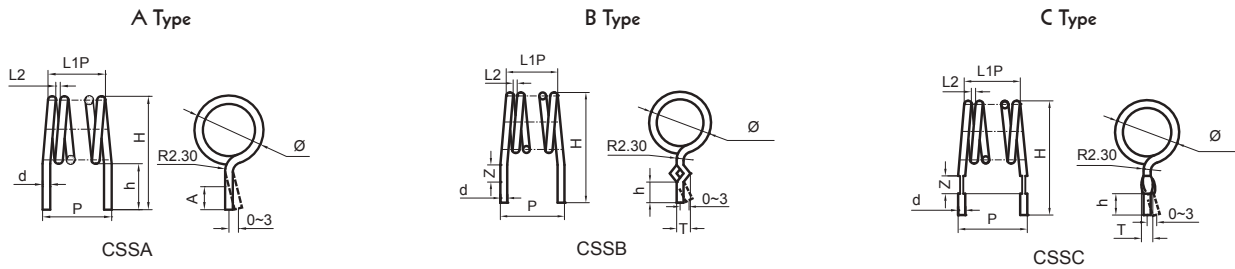

Specification (性能)

| Size 规格 | Wire 线径 | Rated current 额定电流 | T.C.R 温度系数 | Resistance Range 阻值范围 ±5% |
|----------------|------------|-----------------------|---------------|------------------------------|
| CSSA CSSB CSSC | 0.8 | 4.5A | ±100PPM | 15mΩ~100mΩ |
| | 1.0 | 5.5A | | 10mΩ~100mΩ |
| | 1.6 | 9.5A | | 10mΩ~50mΩ |
| | 2.0 | 12A | | 10mΩ~50mΩ |

• Diameter according to this table listed, d, P, h, H, Ø could be design by customer's requirement (线径如本表所示, d、P、h、H、Ø 可以根据客户的要求进行设计)

Ordering Procedure (Example: CSSCØ1.0 5% 50mΩ B/B)

订购方式 (例如: CSSC10J050LB00)

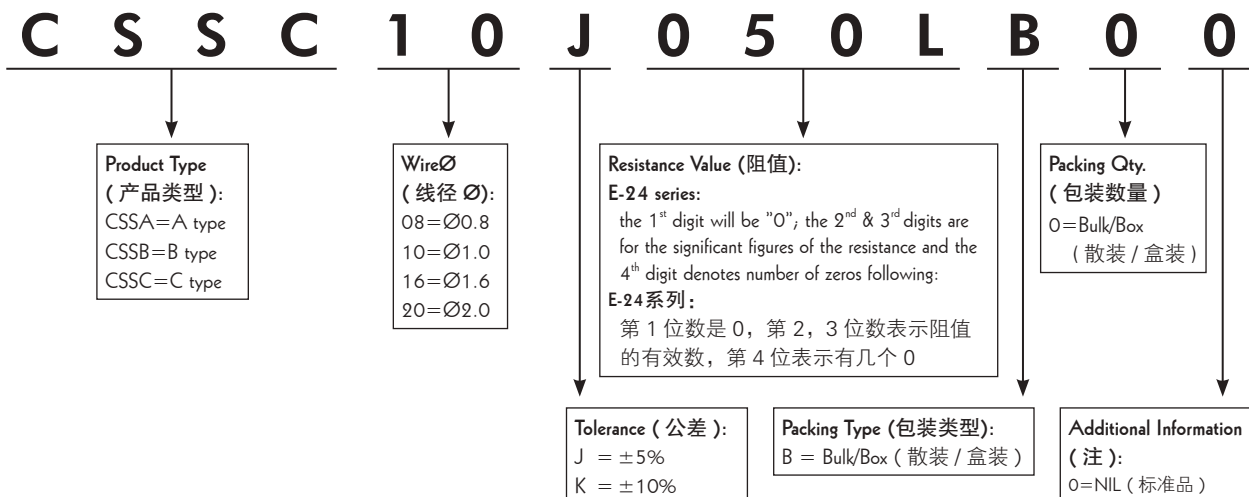

Feature (特性)

- Provide high stable performance against environment conditions & overload voltage
耐高压，稳定性强，抗湿热高温环境
- Can withstand High Surge Voltage
可承受高浪涌电压
- Width resistance range & low TCR
阻值范围宽，温度系数低



- 5 band color code for $\pm 5\%$ tolerance, and last band Black color for identification
公差 $\pm 5\%$ 有五道色码，最后一道以黑色标示

- Standard 5 band color code for $\pm 1\%$ tolerance
公差 $\pm 1\%$ 有五道色码

Surge Withstanding Voltage (承受浪涌电压)

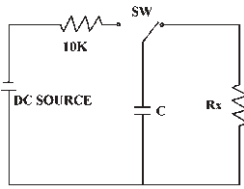

Derating Curve (降功率曲线)

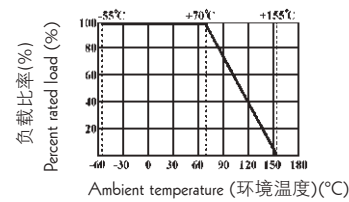

- Normal Size: the discharge cycle is repeated in above circuit: 2.5 seconds "ON", 2.5 seconds "OFF", 50 cycles, $C=0.001\mu f$
正常尺寸: 上图中充放电回路: 2.5秒"通", 2.5秒"断", 50次循环, 电容容值 $C=0.001\mu f$
- Small Size: the discharge cycle is repeated in above circuit: 2.5 seconds "ON", 2.5 seconds "OFF", 10 cycles, $C=0.01\mu f$
小型化产品: 上图中充放电回路: 2.5秒"通", 2.5秒"断", 10次循环, 电容容值 $C=0.01\mu f$
- The applied DC source voltage is shown as below table (电路中的直流电压如下表“承受浪涌电压”所述)

Specification (性能)

| Part No. 料号 | Type 型号 | Power Rating 功率 70°C | Dimension(尺寸)(mm) | | | | Max. Working Voltage 最大工作电压 | Max. Overload Voltage 最大过负荷电压 | Dielectric Withstanding Voltage 绝缘耐压 | Surge Withstanding Voltage 浪涌电压 | Resistance Range 阻值范围 |
|---|------------|----------------------------|-------------------|-------------|--------------|-----------|--------------------------------|----------------------------------|---|---|---------------------------------------|
| | | | D ± 0.5 | L ± 1.0 | d ± 0.05 | H ± 3 | | | | | |
| Normal Size (正常尺寸) | | | | | | | | | | | |
| MGR 0W4 | MGR 25 | 1/4W | 2.2 | 6.5 | 0.54 | 28 | 500V | 700V | 500V | 100K-100M: 10,000V | 1K-100M ($\pm 5\%$, $\pm 10\%$) |
| MGR 0W2 | MGR 50 | 1/2W | 3.0 | 9.5 | 0.54 | 28 | 700V | 1,000V | 700V | | |
| MGR 01W | MGR-100 | 1W | 4.0 | 11.5 | 0.65 | 28 | 1,000V | 1,400V | 700V | | |
| MGR 02W | MGR-200 | 2W | 5.0 | 15.5 | 0.75 | 28 | 1,000V | 1,400V | 700V | | |
| MGR 03W | MGR-300 | 3W | 6.0 | 17.5 | 0.75 | 28 | 1,000V | 1,400V | 700V | | 100K-1M($\pm 1\%$) |
| Small Size & Ultra Small Size (小型化及超小型化尺寸) | | | | | | | | | | | |
| MGR0U2 | MGR-50-SS | 1/2W | 2.2 | 6.5 | 0.54 | 28 | 500V | 700V | 500V | 100K-1M:3,000V 1M1-6M2:4,000V $\geq 6M8$: 6,000V | 1K-33M ($\pm 5\%$, $\pm 10\%$) |
| MGR0S2 | MGR-50-S | 1/2W | 3.0 | 9.0 | 0.54 | 28 | 500V | 700V | 500V | 100K-1M:3,000V 1M1-6M2:4,000V $\geq 6M8$: 6,000V | 100K-1M ($\pm 1\%$) |
| MGR01U | MGR-100-SS | 1W | 3.5 | 9.5 | 0.54 | 28 | 700V | 1,000V | 700V | 100K-1M:4,000V 1M1-6M2:5,000V $\geq 6M8$: 8,000V | 1K-33M ($\pm 5\%$, $\pm 10\%$) |
| MGR01S | MGR-100-S | 1W | 3.5 | 9.5 | 0.65 | 28 | 700V | 1,000V | 700V | | |
| MGR02U | MGR-200-SS | 2W | 4.0 | 11.5 | 0.65 | 28 | 1,000V | 1,400V | 700V | | |
| MGR02S | MGR-200-S | 2W | 4.5 | 11.5 | 0.65 | 28 | 1,000V | 1,400V | 700V | | |
| MGR03U | MGR-300-SS | 3W | 4.5 | 11.5 | 0.75 | 28 | 1,000V | 1,400V | 700V | 100K-1M:5,000V 1M1-6M2:6,000V $\geq 6M8$: 9,000V | 100K-1M ($\pm 1\%$) |
| MGR03S | MGR-300-S | 3W | 5.0 | 15.5 | 0.75 | 28 | 1,000V | 1,400V | 700V | 100K-1M:8,000V 1M1-6M2:9,000V $\geq 6M8$:10,000V | |

Performance Specifications (性能)

| | | |
|---------------------------------|--------|---|
| Temperature coefficient | 温度系数 | $\leq \pm 200\text{PPM}/^\circ\text{C}$ |
| Short-time overload | 短时间过负荷 | $\Delta R/R \leq \pm(1\%+0.05\Omega)$, with no evidence of mechanical damage (无可见机械损伤) |
| Dielectric withstanding voltage | 绝缘耐压 | No evidence of flashover, mechanical damage, arcing or insulation breakdown (无击穿、飞弧及可见机械损伤) |
| Pulse overload | 脉冲过负荷 | $\Delta R/R \leq \pm(2\%+0.05\Omega)$, with no evidence of mechanical damage (无可见机械损伤) |
| Terminal strength | 端子强度 | No evidence of mechanical damage (无可见机械损伤) |
| Soldering heat | 耐焊接热 | $\Delta R/R \leq \pm(1\%+0.05\Omega)$, with no evidence of mechanical damage (无可见机械损伤) |
| Solderability | 可焊性 | Min. 95% coverage (最少 95% 覆盖率) |
| Resistance to solvent | 耐溶剂 | No deterioration of protective coating and marking (包封层, 色码完整) |
| Temperature cycling | 温度循环 | $\Delta R/R \leq \pm(1\%+0.05\Omega)$, with no evidence of mechanical damage (无可见机械损伤) |
| Load life in humidity | 湿度寿命 | $\Delta R/R \leq \pm(5\%+0.05\Omega)$, with no evidence of mechanical damage (无可见机械损伤) |
| Load life | 负载寿命 | $\Delta R/R \leq \pm(5\%+0.05\Omega)$, with no evidence of mechanical damage (无可见机械损伤) |

Ordering Procedure (Example: MGR 1W 5% 27MΩ T/B-1000)

订购方式 (例如: MGR 1W 5% 27MΩ T/B-1000)

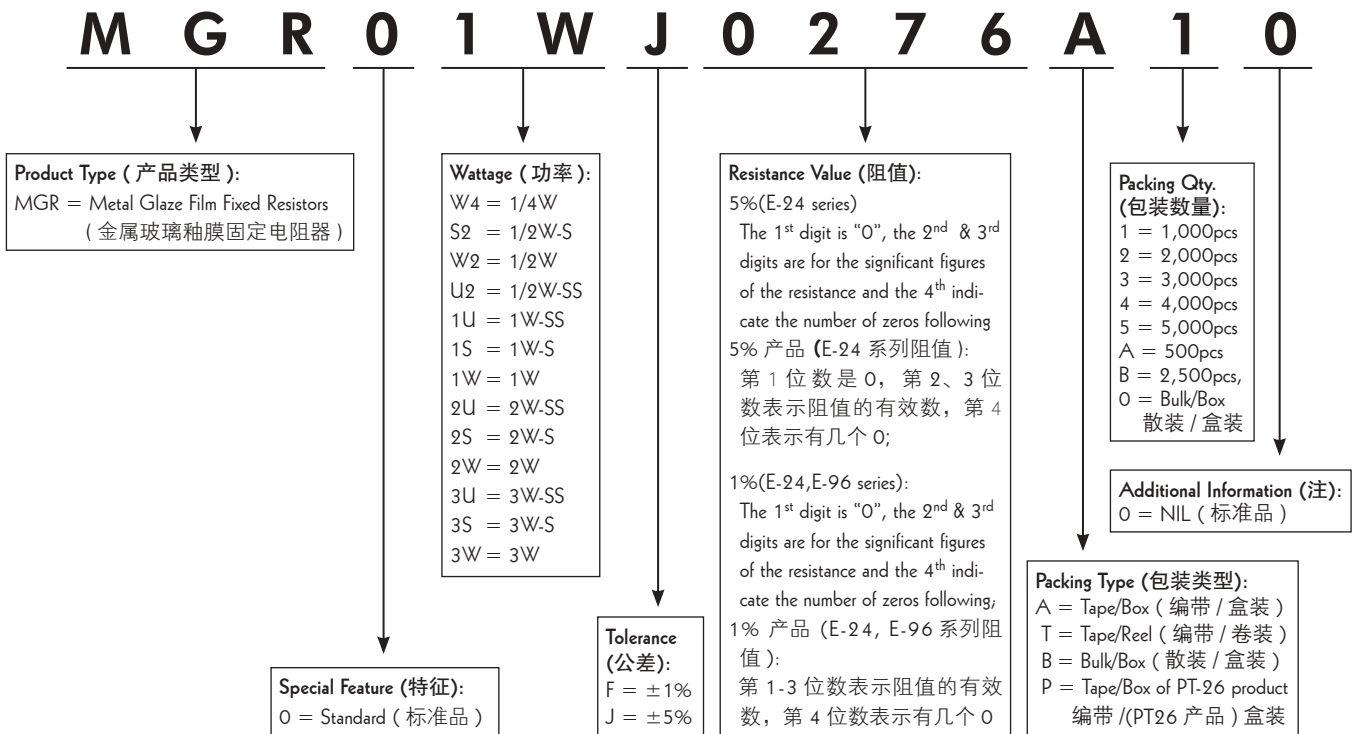

Surge Withstanding Voltage (承受浪涌电压)

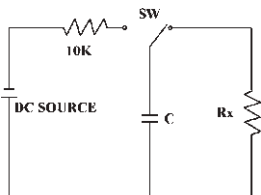

Discharge cycle: 2.5 seconds "ON", 2.5 seconds "OFF", 50 cycles, C=0.001uF
 充放电回路: 2.5秒“通”, 2.5秒“断”, 50次循环, 电容容值 C=0.001uF

Derating Curve (降功率曲线)

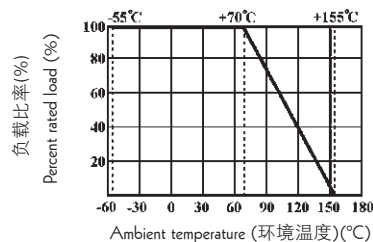

Specification (性能)

| Part No. 料号 | Type 类型 | Power Rating 功率 70°C | Dimension (尺寸)(mm) | | | | Max. Working Voltage 最大工作电压 | Max. Overload Voltage 最大过负荷电压 | Dielectric Withstanding Voltage 绝缘耐压 | Surge Withstanding Voltage 浪涌电压 | Resistance Range 阻值范围 |
|----------------|------------|----------------------------|--------------------|-------|--------|-----|--------------------------------|----------------------------------|---|------------------------------------|---|
| | | | D±0.5 | L±1.0 | d±0.05 | H±3 | | | | | |
| HMGR 0W4 | HMGR-25 | 1/4W | 2.2 | 6.5 | 0.6 | 28 | 500V | 1,000V | 700V | 10 KV | 500K-510MΩ (5% 10%) ≤10M ±1% 10M~100M: ±2% |
| HMGR 0W2 | HMGR-50 | 1/2W | 3.0 | 9.5 | 0.6 | 28 | 1,000V | 2,000V | 700V | | |
| HMGR 01W | HMGR-100 | 1W | 4.0 | 11.5 | 0.7 | 28 | 2,000V | 3,000V | 1,000V | | 500K-1GΩ (5% 10%) ≤10M ±1% 10M~100M: ±2% 101M~510M: ±5% |
| HMGR 02W | HMGR-200 | 2W | 5.0 | 15.5 | 0.8 | 28 | 3,000V | 4,000V | 1,000V | | |

Ordering Procedure (Example: HMGR 1W 5% 200MΩ T/B -1000)

订购方式 (例如: HMGR 1W 5% 200MΩ T/B -1000)

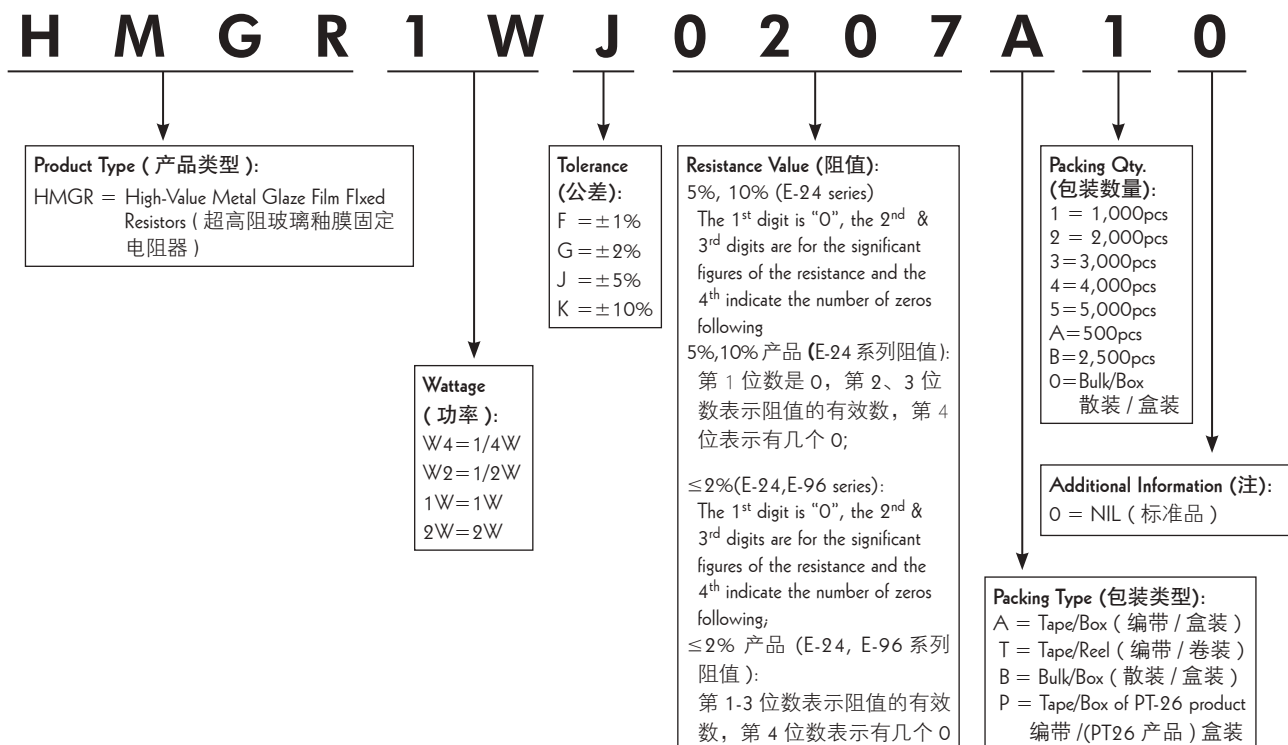

Surge Withstanding Voltage (承受浪涌电压)

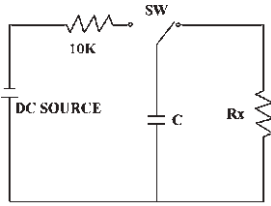

Discharge cycle: 2.5 seconds "ON", 2.5 seconds "OFF", 50 cycles, C=0.001uF
 充放电回路: 2.5秒“通”, 2.5秒“断”, 50次循环, 电容容值 C=0.001uF

Derating Curve (降功率曲线)

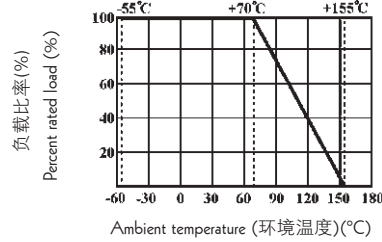

Specification (性能)

| Part No. 料号 | Type 类型 | Power Rating 功率 70°C | Dimension (尺寸)(mm) | | | | Max. Working Voltage 最大工作电压 | Max. Overload Voltage 最大过负荷电压 | Dielectric Withstanding Voltage 绝缘耐压 | Surge Withstanding Voltage 浪涌电压 | Resistance Range 阻值范围 |
|----------------|------------|----------------------------|--------------------|-------|--------|-----|--------------------------------|----------------------------------|---|------------------------------------|----------------------------|
| | | | D±0.5 | L±1.0 | d±0.05 | H±3 | | | | | |
| HVR0W4 | HVR-25 | 1/4W | 2.5 | 6.5 | 0.6 | 28 | 1,600V | 2,000V | 700V | 10,000V | 100K - 100M (±5%, ±10%) |
| HVR0W2 | HVR-50 | 1/2W | 3.5 | 9.5 | 0.6 | 28 | 3,500V | 4,000V | 700V | | 100K - 1M (±1%) |
| HVR01W | HVR-100 | 1W | 4.5 | 11.5 | 0.7 | 28 | 3,500V | 4,000V | 1000V | | |
| HVR02W | HVR-200 | 2W | 5.5 | 16.0 | 0.8 | 28 | 3,500V | 4,000V | 1000V | | |

Ordering Procedure (Example: HVR 1W 5% 27MΩ T/B -1000)

订购方式 (例如: HVR 1W 5% 27MΩ T/B -1000)

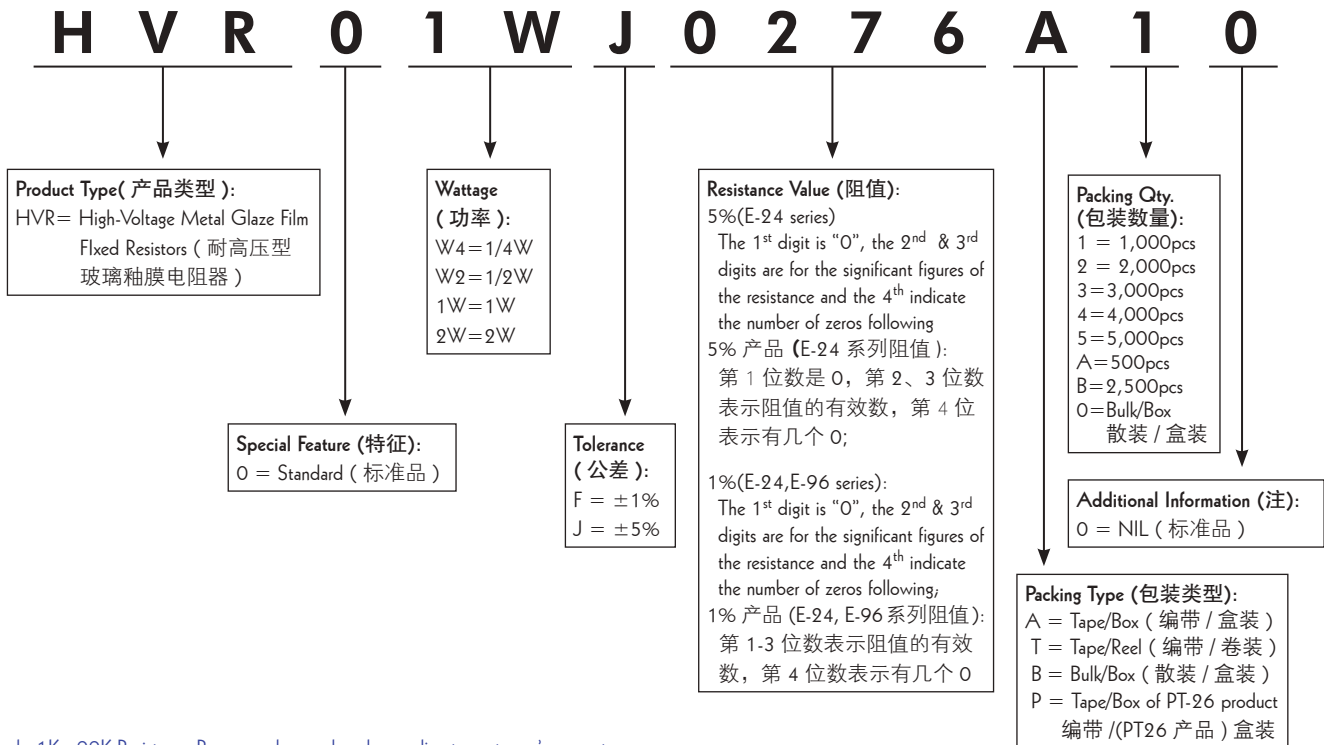

Remark: 1K~99K Resistance Range can be produced according to customer's request.
 备注: 1K~99K 阻值也可以根据客户的要求生产。

Feature (特性)

- Excellent flame retardant coating 优异不燃性涂装
- High Stability even in bad environment 恶劣环境下同样稳定工作
- High purity ceramic core 高纯度瓷芯
- High safety standard 电器性能稳定
- Meet EIAJ-RC2655A requirements 达到 EIAJ-RC2655A 标准要求
- Too low or too high ohmic value can be provided on a case to case basis 超低或超高阻值也能特别提供

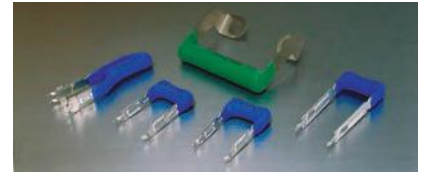

Vertical type - TMOV

端片 MOR 电阻-立式 (TMOV)

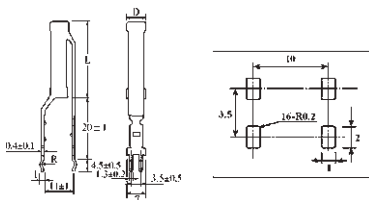

"L" type terminal - TMOL

端片 MOR 电阻-L型端片 (TMOL)

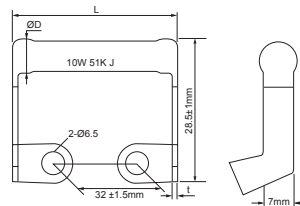

Radial type - TMOR

端片 MOR 电阻-卧式 (TMOR)

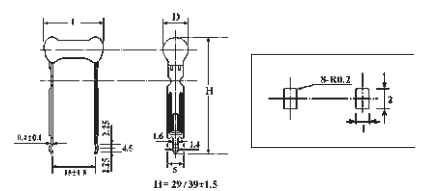

Specification (性能)

| Part No. 料号 | Type 类型 | Power Rating 功率 70°C | Dimension (尺寸)(mm) | | Max. Working Voltage 最大工作电压 | Max. Overload Voltage 最大过负荷电压 | Resistance Range 阻值范围 (5%) |
|----------------|------------|----------------------------|--------------------|-----------|-----------------------------------|-------------------------------------|----------------------------------|
| | | | L ± l | D ± l | | | |
| TMOV5W | TMOV-500 | 5W | 20 | 7 | 500V | 800V | 10Ω ~ 10KΩ |
| TMOV7W | TMOV-700 | 7W | 30 | 7 | 500V | 800V | 10Ω ~ 10KΩ |
| TMOLAW | TMOL-10W | 10W | 46 Max 最大 | 10 Max 最大 | 500V | 800V | 100Ω ~ 82KΩ |
| TMOR3W | TMOR-300 | 3W | 16 | 6 | 350V | 600V | 10Ω ~ 10KΩ |
| TMOR5W | TMOR-500 | 5W | 18 | 7 | 500V | 800V | 10Ω ~ 10KΩ |

Ordering Procedure (Example: TMOV 5W 5% 1KΩ B/B)

订购方式 (例如: TMOV 5W 5% 1KΩ B/B)

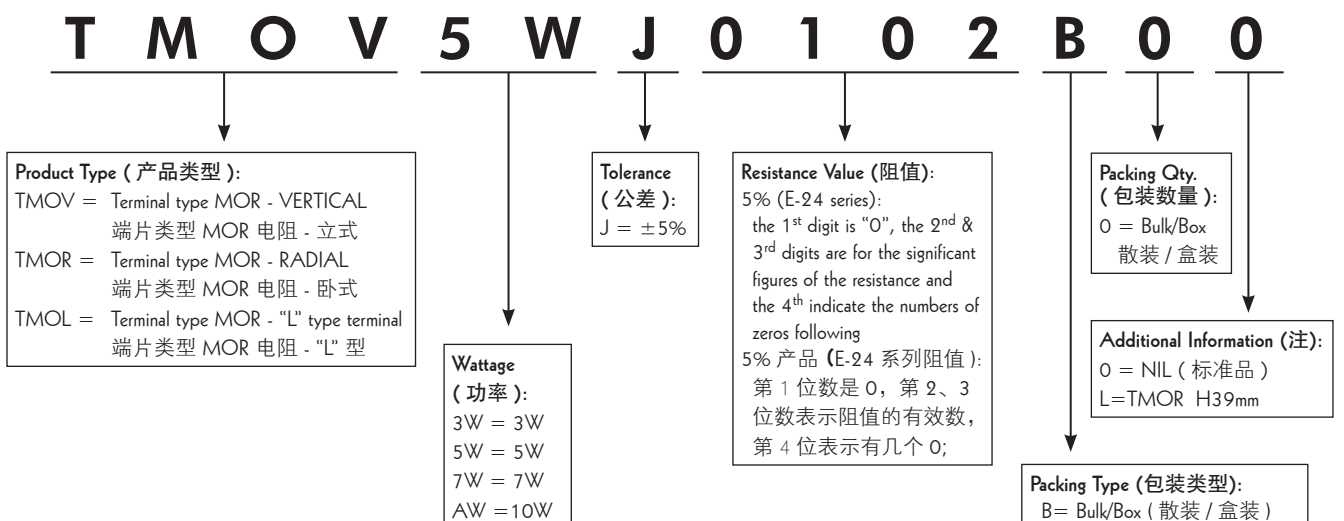

ZW Type (ZW 型)

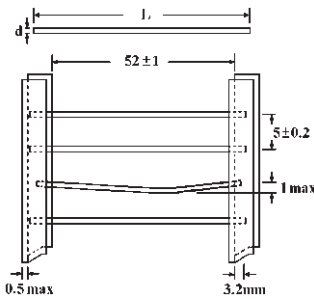

ZO Type (ZO 型)

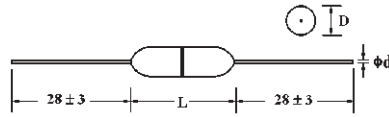

Body material (ZO type): Iron rod painted
 本体材料 (ZO 型): 铁棒涂漆

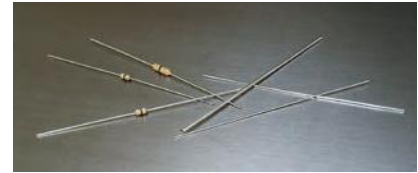

CFR Type (CFR 型)



Body material (CFR type): Electrical grade, copper film ceramic rod.
 本体材料 (CFR 型): 镀铜瓷棒

| Part No. 料号 | Type 类型 | Dimension (尺寸) (mm) | | Resistance Range 阻值范围 (≤mΩ) |
|----------------|------------|---------------------|----------|-----------------------------------|
| | | L ± 3 | d ± 0.05 | |
| ZWA0 | ZW-A | 60 | 0.45 | 50 |
| ZWB0 | ZW-B | 60 | 0.54 | 50 |
| ZWC0 | ZW-C | 60 | 0.65 | 50 |
| ZWD0 | ZW-D | 60 | 0.75 | 50 |
| ZWF0 | ZW-F | 60 | 1.00 | 50 |

| Part No. 料号 | Type 类型 | Power Rating 功率 70°C | Dimension (尺寸) (mm) | | | Resistance Range 阻值范围 (≤mΩ) |
|----------------|------------|----------------------------|---------------------|---------|----------|-----------------------------------|
| | | | D±0.3 | L | d ± 0.05 | |
| ZO00W8 | ZO-12 | 1/8W | 1.8 | 3.2±0.2 | 0.45 | 10 |
| ZO00W4 | ZO-25 | 1/4W | 2.1 | 6.0±0.5 | 0.54 | 10 |
| CFR0W8 | CFR-12 | 1/8W | 1.9 | 3.3±0.3 | 0.45 | 50 |
| CFR0W4 | CFR-25 | 1/4W | 2.2 | 6.5±1.0 | 0.54 | 50 |

Performance Specifications (性能)

| | | |
|---------------------------------|------|---|
| Lead material | 引线材料 | Tin-plated copper (镀锡铜线) |
| Insulation resistance | 绝缘阻值 | Dry (干态) - 10,000 MΩ; Wet (湿态) - 100MΩ |
| Dielectric withstanding voltage | 绝缘耐压 | Atmospheric (正常气压) - 500V RMS; Reduced (减压) - 325V RMS |
| Rated current | 额定电流 | 1/8W 70°C 1.5A; 1/4W 70°C 2.5A, derating to 0 AMPS at 150°C 1/8W 70°C 1.5A; 1/4W 70°C 2.5A, 150°C 时, 电流降低到 0A. |

Ordering Procedure (Example: ZO 1/4W T/R-5,000)

订购方式 (例如: ZO 1/4W T/R-5,000)



Copper Plated Wire Type (CP) [铜包钢 (CP) 型]

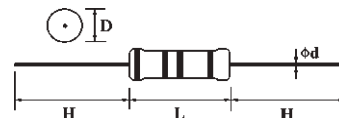

| Part No. 料号 | Type 类型 | Power Rating 功率 70°C | Dimension (尺寸)(mm) | | | | Max. Working Voltage 最大工作电压 | Max. Overload Voltage 最大过负荷电压 | Resistance Range 阻值范围 |
|----------------|------------|----------------------------|--------------------|----------------|--------|-------|-----------------------------------|-------------------------------------|--------------------------|
| | | | D Max. D 最大 | L Max. L 最大 | d±0.02 | H±3 | | | |
| CP00W4 | CP-25 | 1/4W | 2.5 | 6.8 | 0.5 | 28/38 | 250V | 500V | 1Ω ~ 10MΩ |
| CP00S3 | CP-33-S | 1/3W | 2.5 | 6.8 | 0.5 | 28/38 | 300V | 600V | 1Ω ~ 10MΩ |
| CP00W3 | CP-33 | 1/3W | 3 | 9 | 0.5 | 28 | 300V | 600V | 1Ω ~ 10MΩ |
| CP00S2 | CP-50-S | 1/2W | 3 | 9 | 0.5 | 28 | 350V | 700V | 1Ω ~ 10MΩ |

Cutting Type (CO) [切割半成品型 (CO) 型]



| Part No. 料号 | Type 类型 | Power Rating 功率 70°C | Dimension (尺寸)(mm) | | Resistance Range 阻值范围 |
|----------------|------------|----------------------------|---------------------------------------|---------------------------------------|--------------------------|
| | | | D | L | |
| CO...W8 | CO-12 | 1/8W | 1.6 ^{+0.10} _{-0.00} | 3.2 ±0.10 | 1Ω ~ 10MΩ |
| CO...W4 | CO-25 | 1/4W | 2.1 ^{+0.09} _{-0.00} | 5.6 ^{+0.10} _{-0.20} | 1Ω ~ 10MΩ |
| CO...W4...A | CO-25-A | 1/4W | 2.1 ^{+0.09} _{-0.00} | 5.9 ^{+0.10} _{-0.15} | 1Ω ~ 10MΩ |
| CO...W4...B | CO-25-B | 1/4W | 2.1 ^{+0.09} _{-0.01} | 6.4 ^{+0.10} _{-0.15} | 1Ω ~ 10MΩ |

• Cutting type resistors are produced without lead-wire and without coating
切割型半成品型电阻无导线，无涂装

• Cap plated option: 1. Tin-plated 2. Nickel-Plated
铁帽：1 镀锡 2 镀镍

Ordering Procedure (Example: CPL 1/4W 5% H=38mm 10Ω T/B-5000)

订购方式 (例如: CPL 1/4W 5% H=38mm 10Ω T/B-5000)

C P L 0 W 4 J 0 1 0 0 A 5 0

Product Type (产品类型):

CPO = Cooper plated steel lead wire, (铜包钢导线) H=28mm

CPL = Cooper plated steel lead wire, (铜包钢导线) H=38mm

COT = Cutting type (Tin-plated Cap) [切割型 (镀锡铁帽)]

CON = Cutting type (Nickel-plated Cap) [切割型 (镀镍铁帽)]

Special Feature (特征):

O = Standard (标准品)

F = Flame retardant (阻燃型)

I = Non-Inductive (无感型)

Wattage (功率):

W8 = 1/8W

W4 = 1/4W

W3 = 1/3W

Tolerance (公差):

G = ±2%

J = ±5%

K = ±10%

Packing Type (包装类型):

A = Tape/Box (编带 / 盒装)

T = Tape/Reel (编带 / 卷装)

B = Bulk/Box (散装 / 盒装)

"B" (B/B) is the only available packing for Cutting type ["B" (B/B) 只能用于切割型]

Resistance Value (阻值):

5%, 10% (E-24 series): The 1st digit is "0", the 2nd & 3rd digits are for the significant figures of the resistance and the 4th indicate the number of zeros following

5%, 10% 产品 (E-24 系列阻值): 第 1 位数是 0, 第 2、3 位数表示阻值的有效数, 第 4 位表示有几个 0;

2% (E-24 series): The 1st digit is "0", the 2nd & 3rd digits are for the significant figures of the resistance and the 4th indicate the number of zeros following;

2% 产品 (E-24 系列阻值): 第 1-3 位表示阻值的有效数, 第 4 位表示有几个 0.

Packing Qty. (包装数量):

1 = 1,000pcs, 2 = 2,000pcs,

3 = 3,000pcs, 4 = 4,000pcs,

5 = 5,000pcs, A = 500pcs,

B = 2,500pcs,

0 = Bulk/Box (散装 / 盒装)

Additional Information (注):

O = CP type (CP型),

A = CO-25-A, B = CO-25-B

Feature (特性)

- This specification is applicable for CFR 1/4W, MFR1/4W, MOR 1/4W, MOR1WS, MOR2WS, KNP1WS, KNP2WS product only, other product (size), please consult factory for the available specification and drawing.
- 下图规格适用于 CFR 1/4W, MFR1/4W, MOR 1/4W, MOR1WS, MOR2WS, KNP1WS, KNP2WS. 其它产品的立式加工, 可洽询工厂以取得可生产的规格图样。

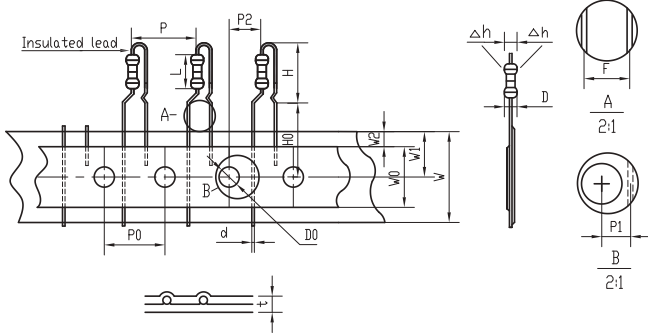

P₀ cumulative pitch error 1 mm / 20 pitch
(注: P₀ 累积脚距误差 1.0mm / 20 脚距)

Max. (最大) Min. (最小)

| Project (项目) | 1/4W | 1WS | 2WS |
|--|-----------|-------------|-------------|
| Body diameter (D) 本体直径 | 2.5 Max. | 3.5±0.5 | 4±0.5 |
| Body length (L) 本体长度 | 6.8 Max. | 9±1.0 | 12±1.0 |
| Body height (H) 本体高度 | 12 Max. | 19 Max. | 21 Max. |
| Lead-wire diameter (d) 导线直径 | 0.54±0.05 | 0.65±0.05 | 0.65±0.05 |
| Pitch of component (P) 零件间距 | 12.7±1 | 12.7±1 | 12.7±1 |
| Feed hole pitch (P ₀) 孔距 | 12.7±0.3 | 12.7±0.3 | 12.7±0.3 |
| Hole center to lead (P ₁) 中心测量 | 3.85±0.7 | 3.85±0.7 | 3.85±0.7 |
| Hole center to body (P ₂) 孔心至本体 | 6.35±1.3 | 6.35±1.3 | 6.35±1.3 |
| Lead to lead distance (F) 两脚导线中心测量 | 5±1 | 5±1 | 5±1 |
| Component alignment (Δh) 零件偏移 | 0±1 | 0±2 | 0±2 |
| Tape width (W) 纸带宽度 | 18±1 | 18+1.0/-1.5 | 18+1.0/-1.5 |
| Hole position (W ₁) 孔位 | 9±0.5 | 9±0.5 | 9±0.5 |
| Lead-wire clinch height (H ₀) 导线固定端高度 | 16.5 Max. | 16±0.5 | 16±0.5 |
| Feed hole diameter (D ₀) 孔径 | 4±0.3 | 4±0.3 | 4±0.3 |
| Total tape thickness (t) 纸带总厚 | 0.5±0.2 | 0.5±0.2 | 0.5±0.2 |
| Sticky tape width (W ₀) 热熔胶带宽 | 12.5 Min. | 12.5 Min. | 12.5 Min. |
| Uncovered paper tape width (W ₂) 纸带露出宽度 | 3.0 Max. | 1.5 Max. | 1.5 Max. |

Ordering Procedure (Example: CFR 1/4W 5% 100KΩ T/B-2000 PANASERT Type)

订购方式 (例如: CFR 1/4W 5% 100K Ω T/B-2000 PANASERT 型)



Avisert (1) Type [Avisert (1) 型]

- This specification is applicable for CFR 1/4W & MFR 1/4W product only; other product (size), please consult factory for the available specification and drawing.
- 适用于CFR 1/4W 和 MFR 1/4 W 固定电阻。其它产品的立式加工，可洽询工厂以取得可生产的规格图样。

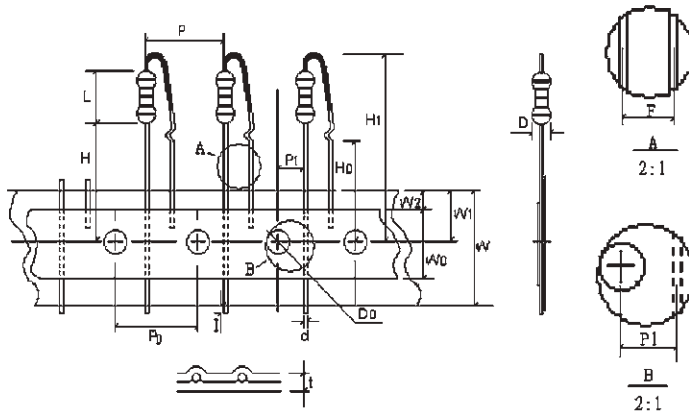

Max. (最大) Min. (最小)

| | | |
|--|-------------------|------------|
| Body diameter 本体直径 | (D) | 2.5 Max. |
| Body length 本体长度 | (L) | 6.8 Max. |
| Lead-wire diameter 导线直径 | (d) | 0.54±0.05 |
| Pitch of component 零件间距 | (P) | 12.7±1 |
| Feed hole pitch 孔距 | (P ₀) | 12.7±0.3 |
| Hole center to lead 孔心至导线中心测量 | (P ₁) | 3.85±0.7 |
| Lead to lead distance 两脚导线中心测量 | (F) | 5±1 |
| Tape width 纸带宽度 | (W) | 18±1 |
| Hole position 孔位 | (W ₁) | 9±0.5 |
| Lead-wire clinch height 导线固定端高度 | (H ₀) | 16.5 Max. |
| Component height 零件高度 | (H ₁) | 32.25 Max. |
| Lead wire protrusion 导线伸出长度 | (I) | 1.0 Max. |
| Feed hole diameter 孔径 | (D ₀) | 4±0.3 |
| Total tape thickness 纸带总厚 | (t) | 0.5±0.2 |
| Sticky tape width 胶带宽度 | (W ₀) | 12.5 Min. |
| Uncovered paper tape width 纸带露出宽度 | (W ₂) | 3.0 Max. |
| Height of component from tape center 零件至纸带中间的高度 | (H) | 17.3 ± 0.5 |

Avisert (2) Type [Avisert (2) 型]

- This specification is applicable for CFR 1/8W & MFR 1/8W product only; other product (size), please consult factory for the available specification and drawing.
- 适用于 CFR 1/8W 和 MFR 1/8W 固定电阻。其它产品的立式加工，可洽询工厂以取得可生产的规格图样。

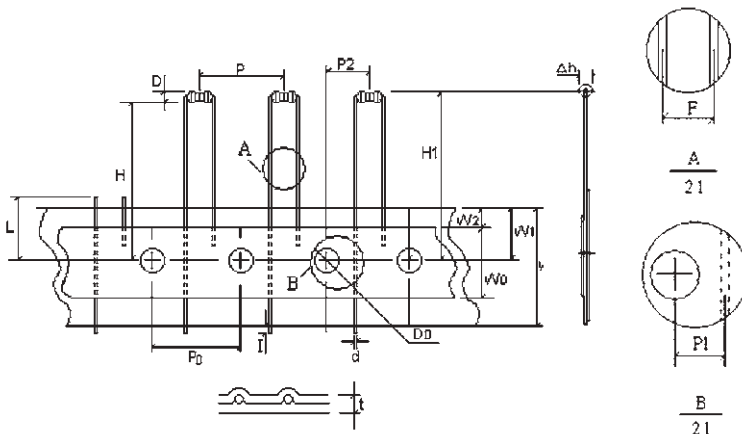

Max. (最大) Min. (最小)

| | | |
|--|-------------------|------------|
| Body diameter 本体直径 | (D) | 2.5 Max. |
| Lead-wire diameter 导线直径 | (d) | 0.54±0.05 |
| Pitch of component 零件间距 | (P) | 12.7±1 |
| Feed hole pitch 孔距 | (P ₀) | 12.7±0.3 |
| Hole center to lead 中心测量 | (P ₁) | 3.85±0.7 |
| Lead to lead distance 两脚导线中心测量 | (F) | 5±1 |
| Component alignment 零件偏移 | (Δh) | 0 ± 1 |
| Tape width 纸带宽度 | (W) | 18±1 |
| Hole position 孔位 | (W ₁) | 9±0.5 |
| Lead wire clinch height 导线固定端高度 | (H) | 21.0 Max. |
| Component height 零件高度 | (H ₁) | 32.25 Max. |
| Lead wire protrusion 导线伸出长度 | (I) | 1.0 Max. |
| Feed hole diameter 孔径 | (D ₀) | 4±0.3 |
| Total tape thickness 纸带总厚 | (t) | 0.5±0.2 |
| Sticky tape width 热熔胶带宽 | (W ₀) | 12.5 Min. |
| Uncovered paper tape width 纸带露出宽度 | (W ₂) | 3.0 Max. |
| Length of snipped lead 剪脚长度 | (L) | 11.0 Max. |
| Hole center to component center 孔心至零件中心距离 | (P ₂) | 6.35 ± 1.3 |

Remark: P₀ cumulative pitch error 1.0mm/20pitch (P₀ 累积脚距误差脚距 1.0mm / 20 脚距)

P₁ to be measured at bottom of clinch (P₁ 测量固定端底部)

t: ground paper 0.5 ± 0.1mm (t: 纸带底厚 0.5 ± 0.1mm)

Avisert (3) Type [Avisert (3) 型]

- This specification is applicable for CFR 1/4W, MFR1/4W, MOR 1/4W, MOR1WS, MOR2WS, KNP1WS, KNP2WS product only, other product (size), please consult factory for the available specification and drawing.
- 适用于 CFR 1/4W, MFR1/4W, MOR 1/4W, MOR1WS, MOR2WS, KNP1WS, KNP2WS 其它产品的立式加工, 可洽询工厂以取得可生产的规格图样。

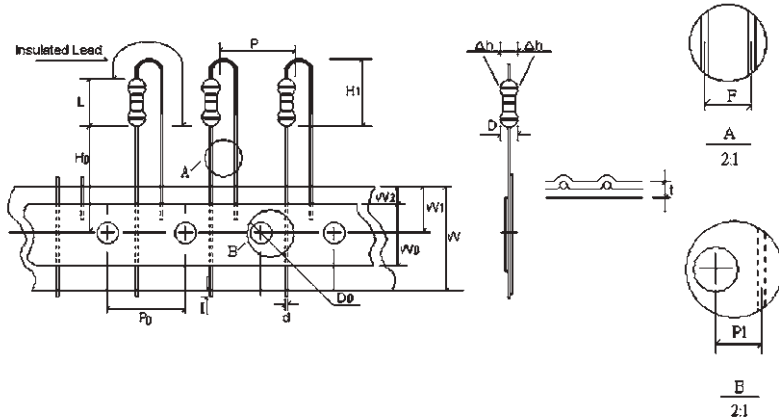

Remark: P₀ cumulative pitch error 1.0mm/20pitch (注: P₀ 累积脚距误差 1.0mm / 20 脚距)

Max. (最大) Min. (最小)

| | | |
|------------------------------------|-------------------|--|
| Body diameter 本体直径 | (D) | 1/8W: 2.0 Max. 1/4W: 2.5 Max. |
| Body length 本体长度 | (L) | 1/8W: 4.2 Max. 1/4W: 6.8 Max. |
| Body height 本体高度 | (H) | 1/8W: 7.0 Max. 1/4W: 10.0 Max. |
| Lead wire diameter 导线直径 | (d) | 1/8W: 0.45 ± 0.05 1/4W: 0.54 ± 0.05 |
| Pitch of component 零件间距 | (P) | 12.7 ± 1 |
| Lead to lead distance 两脚导线中心测量 | (F) | 1/8W: 2.5 ± 1 1/4W: 5 ± 1 |
| Feed hole pitch 孔距 | (P ₀) | 12.7 ± 0.3 |
| Hole center to lead 孔心到导线中心测量 | (P ₁) | 3.85 ± 0.7 |
| Component alignment 零件偏移 | (Δh) | 0 ± 0.1 |
| Paper tape width 纸带宽度 | (W) | 18 ± 1 |
| Hold down tape width 孔至下纸带宽度 | (W ₀) | 12.5 Min |
| Hole position 孔位 | (W ₁) | 9 ± 0.5 |
| Hold down tape position 孔至下纸带位置 | (W ₂) | 3 Max. |
| Lead wire clinch height 导线固定端高度 | (H ₀) | 16.5 Max. |
| Length of snipped lead 剪脚长度 | (H ₁) | 11.0 Max. |
| Lead wire protrusion 导线伸出长度 | (l) | 1.0 Max. |
| Feed hole diameter 孔径 | (d ₀) | 4 ± 0.3 |
| Total paper tape thickness 纸带总厚 | (t) | 0.5 ± 0.2 |

Ordering Procedure (Example: MFR 1/8W 1% 50PPM 221Ω T/R-5000 Avisert 3 Type)

订购方式 (例如: MFR 1/8W 1% 50PPM 221Ω T/R-5000 Avisert 3型)



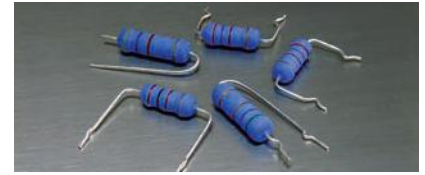

F Forming Type (F 型)

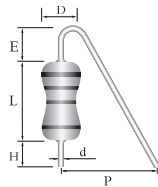

F Type (F 型)



F1 Type (F1 型)



F2 Type (F2 型)



F3 Type (F3 型)

Dimension (尺寸) (mm)

| Power Rating 功率 | L Max. L 最大 | D Max. D 最大 | d ± 0.05 | P ⁺¹ -3 | H ± 1 | E ± 0.5 |
|--------------------|----------------|----------------|----------|-----------------------|-------|---------|
| 1 W (2W-S) | 12 | 5.0 | 0.65 | 8 | 6 | 2.5 |
| 2 W (3W-S) | 16 | 5.5 | 0.70 | 8 | 6 | 2.5 |

• Above specification given for recommendation only, please consult factory for special required specification (以上规格仅供参考, 其它可提供的规格请咨询工厂)

Ordering Procedure (Example: CFR 2W-S 5% 100Ω B/B F1 Type)

订购方式 (例如: CFR 2W-S 5% 100Ω B/B F1 型)

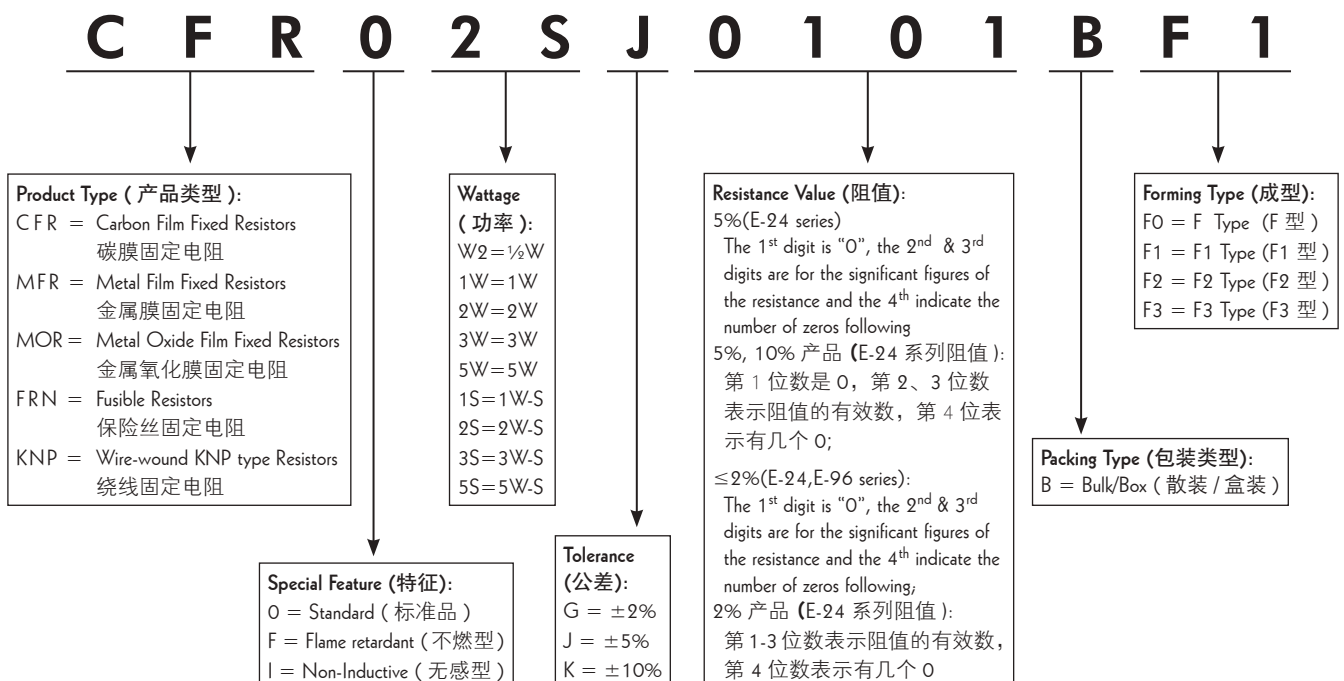

M Forming Type (M 型)

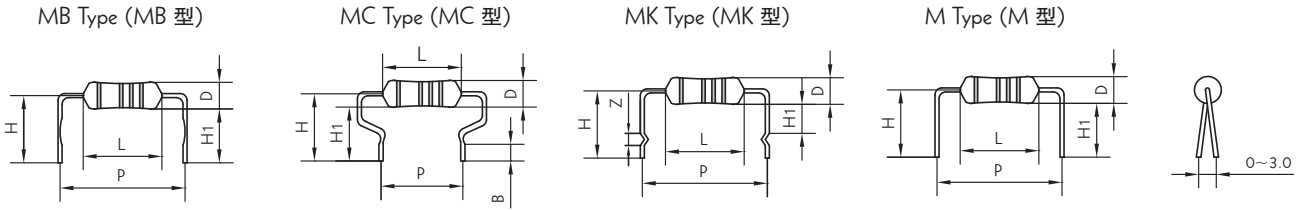

Normal Size (正常尺寸)

| Power Rating 功率 70°C | Dimension (尺寸)(mm) | | | | |
|----------------------------|--------------------|--------------|-----|-------|--------|
| | D Max. 最大 | L Max. 最大 | H±2 | P±1.5 | d±0.05 |
| 1/2W | 4 | 10 | 14 | 13 | 0.54 |
| 1W | 5 | 12 | 14 | 15 | 0.65 |
| 2W | 5.5 | 16 | 18 | 20 | 0.70 |
| 3W | 6.5 | 17.5 | 20 | 25 | 0.75 |
| 5W | 8.5 | 26 | 20 | 31 | 0.75 |

Small Size (小尺寸)

| Power Rating 功率 70°C | Dimension (尺寸)(mm) | | | | |
|----------------------------|--------------------|----------------|-----|-------|--------|
| | D Max. D 最大 | L Max. L 最大 | H±2 | P±1.5 | d±0.05 |
| 1W | 4 | 10 | 14 | 13 | 0.65 |
| 2W | 5 | 12 | 14 | 15 | 0.65 |
| 3W | 5.5 | 16 | 18 | 20 | 0.75 |
| 5W | 8 | 25 | 22 | 31 | 0.75 |

• Above specification given for recommendation only, please consult factory for special required specification (以上规格仅供参考, 其它可提供的规格请咨询工厂)

Ordering Procedure (Example: MOR 1W-S 5% 10Ω B/B M Type with flattened lead wire)

订购方式 (例如: MOR 1W-S 5% 10Ω B/B M 型导线打扁)

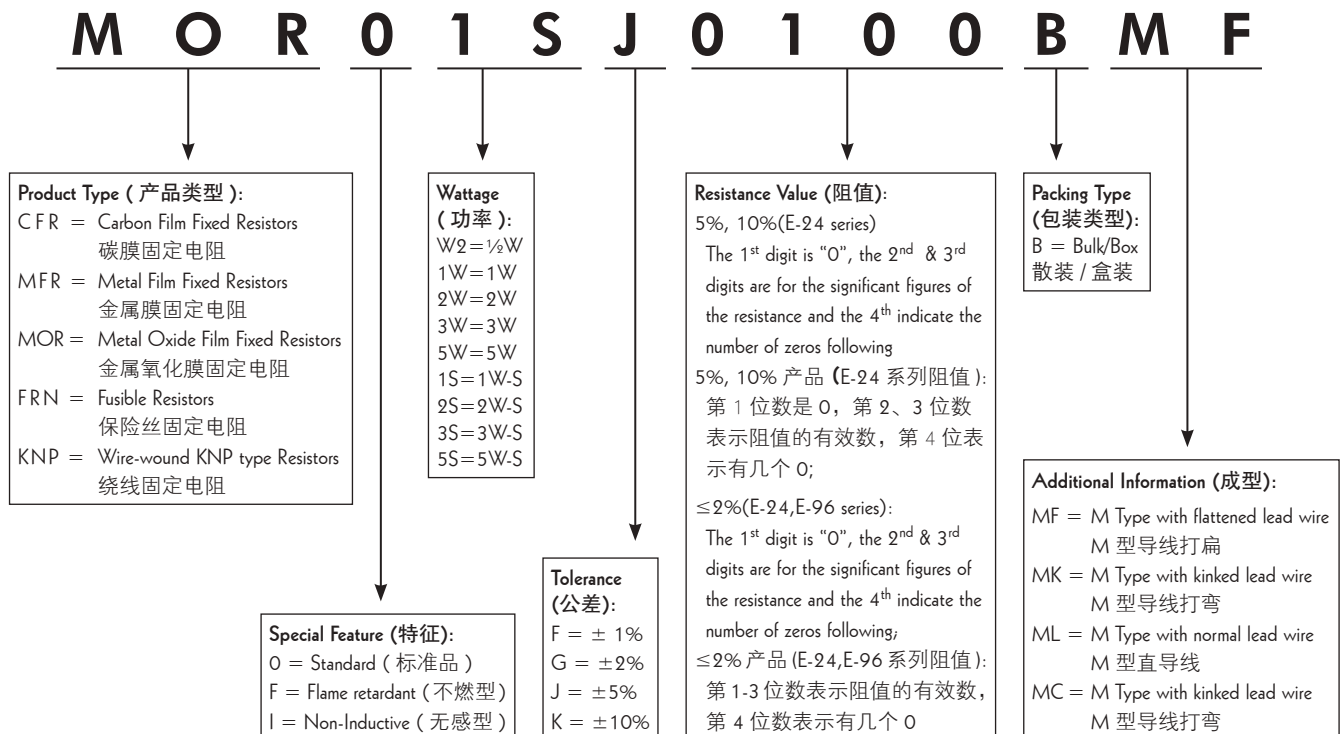

Tape in Box Packing (Ammo Pack) (编带盒装)



*L1-L2=1.0 Max. 最大
 ZW: 0
 **S=0.5 Max. 最大
 PT-26: 0.8 Max. 最大

| Part No. 料号 | Type 类型 | Dimension of T/B (尺寸)(mm) | | | | | Qty./Box 数量/盒 |
|---|------------|---------------------------|----------|-----|-----|-----|------------------|
| | | O | P | A±5 | B±5 | C±5 | |
| Carbon Film Fixed Resistors (碳膜固定电阻) | | | | | | | |
| CFROW8 | CFR-12 | 52 ± 1 | 5 ± 0.3 | 75 | 70 | 255 | 5,000 |
| CFROS4 | CFR-25-S | 52 ± 1 | 5 ± 0.3 | 75 | 70 | 255 | 5,000 |
| CFROW4 | CFR-25 | 52 ± 1 | 5 ± 0.3 | 75 | 98 | 255 | 5,000 |
| CFROU2 | CFR-50-SS | 52 ± 1 | 5 ± 0.3 | 75 | 116 | 255 | 5,000 |
| CFROS2 | CFR-50-S | 52 ± 1 | 5 ± 0.3 | 75 | 70 | 255 | 2,000 |
| CFROW2 | CFR-50 | 52 ± 1 | 5 ± 0.3 | 75 | 45 | 255 | 1,000 |
| CFR01S | CFR-100-S | 58 ± 1 | 5 ± 0.3 | 80 | 82 | 255 | 1,000 |
| CFR01W | CFR-100 | 65 ± 5 | 10 ± 0.5 | 90 | 88 | 255 | 1,000 |
| CFR02S | CFR-200-S | 65 ± 5 | 10 ± 0.5 | 90 | 88 | 255 | 1,000 |
| CFR02W | CFR-200 | 65 ± 5 | 10 ± 0.5 | 90 | 88 | 255 | 500 |
| CFR03S | CFR-300-S | 65 ± 5 | 10 ± 0.5 | 90 | 88 | 255 | 500 |
| Metal Film Fixed Resistors (金属膜固定电阻) | | | | | | | |
| MFLOW8 | MF-12 | 52 ± 1 | 5 ± 0.3 | 75 | 70 | 255 | 5,000 |
| MFR0S4 | MF-25-S | 52 ± 1 | 5 ± 0.3 | 75 | 70 | 255 | 5,000 |
| MFLOW4 | MF-25 | 52 ± 1 | 5 ± 0.3 | 75 | 98 | 255 | 5,000 |
| MFR004 | MF-40-SS | 52 ± 1 | 5 ± 0.3 | 75 | 70 | 255 | 5,000 |
| MFR0U2 | MF-50-SS | 52 ± 1 | 5 ± 0.3 | 75 | 116 | 255 | 5,000 |
| MFR0S2 | MF-50-S | 52 ± 1 | 5 ± 0.3 | 75 | 70 | 255 | 2,000 |
| MFLOW2 | MF-50 | 52 ± 1 | 5 ± 0.3 | 75 | 45 | 255 | 1,000 |
| MFR006 | MF-60-S | 52 ± 1 | 5 ± 0.3 | 75 | 116 | 255 | 5,000 |
| MFR01W | MF-100 | 58 ± 1 | 5 ± 0.3 | 80 | 82 | 255 | 1,000 |
| MFR02W | MF-200 | 65 ± 5 | 10 ± 0.5 | 90 | 88 | 255 | 1,000 |
| MFR03W | MF-300 | 65 ± 5 | 10 ± 0.5 | 90 | 88 | 255 | 500 |
| Metal Oxide Film Fixed Resistors (金属氧化膜固定电阻) | | | | | | | |
| MOR0W4 | MOR-25 | 52 ± 1 | 5 ± 0.3 | 75 | 116 | 255 | 5,000 |
| MOR0S2 | MOR-50-S | 52 ± 1 | 5 ± 0.3 | 75 | 116 | 255 | 5,000 |
| MOR0W2 | MOR-50 | 52 ± 1 | 5 ± 0.3 | 75 | 70 | 255 | 1,000 |
| MOR01S | MOR-100-S | 58 ± 1 | 5 ± 0.3 | 80 | 70 | 255 | 1,000 |
| MOR01W | MOR-100 | 58 ± 1 | 5 ± 0.3 | 80 | 82 | 255 | 1,000 |
| MOR02S | MOR-200-S | 58 ± 1 | 5 ± 0.3 | 80 | 82 | 255 | 1,000 |
| MOR02W | MOR-200 | 65 ± 1 | 10 ± 0.5 | 90 | 119 | 255 | 1,000 |
| MOR03S | MOR-300-S | 65 ± 1 | 10 ± 0.5 | 90 | 119 | 255 | 1,000 |
| MOR03W | MOR-300 | 65 ± 5 | 10 ± 0.5 | 90 | 88 | 255 | 500 |
| MOR05U | MOR-500-SS | 65 ± 5 | 10 ± 0.5 | 90 | 88 | 255 | 500 |
| MOR05S | MOR-500-S | 90 ± 5 | 10 ± 0.5 | 115 | 124 | 500 | 500 |
| Fusible Resistors (保险丝电阻) | | | | | | | |
| FRNOW4 | FRN-25 | 52 ± 1 | 5 ± 0.3 | 75 | 116 | 255 | 5,000 |
| FRNOW2 | FRN-50 | 52 ± 1 | 5 ± 0.3 | 80 | 70 | 255 | 2,000 |
| FRN01W | FRN-100 | 58 ± 1 | 5 ± 0.3 | 80 | 70 | 255 | 1,000 |
| FRN02W | FRN-200 | 58 ± 1 | 5 ± 0.3 | 80 | 82 | 255 | 1,000 |
| FRN03W | FRN-300 | 65 ± 5 | 10 ± 0.5 | 90 | 119 | 255 | 1,000 |

| Part No. 料号 | Type 类型 | Dimension of T/B (尺寸) (mm) | | | | | Qty./Box 数量 / 盒 |
|---|------------|-----------------------------------|--------|-----|-----|-----|--------------------|
| | | O | P | A±5 | B±5 | C±5 | |
| Wire-wound Fixed Resistors (绕线固定电阻) | | | | | | | |
| KNP0W2 | KNP-50 | 58±1 | 5±0.3 | 75 | 70 | 255 | 1,000 |
| KNP01S | KNP-100-S | 58±1 | 5±0.3 | 80 | 70 | 255 | 1,000 |
| KNP01W | KNP-100 | 58±1 | 5±0.5 | 80 | 82 | 255 | 1,000 |
| KNP02S | KNP-200-S | 58±1 | 5±0.5 | 80 | 82 | 255 | 1,000 |
| KNP02W | KNP-200 | 65±5 | 10±0.5 | 90 | 119 | 255 | 1,000 |
| KNP03S | KNP-300-S | 65±5 | 10±0.5 | 90 | 119 | 255 | 1,000 |
| KNP03W | KNP-300 | 65±5 | 10±0.5 | 90 | 88 | 255 | 500 |
| KNP05S | KNP-500-S | 65±5 | 10±0.5 | 90 | 88 | 255 | 500 |
| Jumper Wires & Zero Ohm Resistors (跳线和零欧姆固定电阻) | | | | | | | |
| ZWA0 | ZW-A | 52±1 | 5±0.3 | 75 | 98 | 255 | 10,000 |
| ZWB0 | ZW-B | 52±1 | 5±0.3 | 75 | 116 | 255 | 10,000 |
| ZWC0 | ZW-C | 52±1 | 5±0.3 | 75 | 116 | 255 | 8,000 |
| ZWD0 | ZW-D | 52±1 | 5±0.3 | 75 | 116 | 255 | 8,000 |
| ZWF0 | ZW-F | 52±1 | 5±0.3 | 75 | 116 | 255 | 7,000 |
| ZO00W8 | ZO-12 | 52±1 | 5±0.3 | 75 | 70 | 255 | 5,000 |
| ZO00W4 | ZO-25 | 52±1 | 5±0.3 | 75 | 98 | 255 | 5,000 |
| PT-26 Type (PT-26 类型) | | | | | | | |
| CFROW8 | CFR-12 | 26 ^{+1.5} _{-.1} | 5±0.5 | 50 | 66 | 255 | 5,000 |
| CFROS4 | CFR-25-S | 26 ^{+1.5} _{-.1} | 5±0.5 | 50 | 66 | 255 | 5,000 |
| CFROW4 | CFR-25 | 26 ^{+1.5} _{-.0} | 5±0.5 | 50 | 100 | 255 | 5,000 |
| CFROU2 | CFR-50-SS | 26 ^{+1.5} _{-.0} | 5±0.5 | 50 | 100 | 255 | 4,000 |
| MFLOW8 | MF-12 | 26 ^{+1.5} _{-.1} | 5±0.5 | 50 | 66 | 255 | 5,000 |
| MFR0S4 | MF-25-S | 26 ^{+1.5} _{-.1} | 5±0.5 | 50 | 66 | 255 | 5,000 |
| MFLOW4 | MF-25 | 26 ^{+1.5} _{-.0} | 5±0.5 | 50 | 100 | 255 | 5,000 |
| MFR0U2 | MF-50-SS | 26 ^{+1.5} _{-.0} | 5±0.5 | 50 | 100 | 255 | 4,000 |
| MFR006 | MF-60-S | 26 ^{+1.5} _{-.0} | 5±0.5 | 50 | 100 | 255 | 4,000 |
| Metal Glazed Film Fixed Resistors (金属玻璃釉膜固定电阻) | | | | | | | |
| MGR0W4 | MGR25 | 52±1 | 5±0.3 | 75 | 116 | 255 | 4000 |
| MGR0W2 | MGR-50 | 52±1 | 5±0.3 | 75 | 70 | 255 | 1000 |
| MGR01W | MGR-100 | 58±1 | 5±0.3 | 80 | 82 | 255 | 1000 |
| MGR02W | MGR-200 | 65±5 | 10±0.5 | 90 | 119 | 255 | 1000 |
| MGR03W | MGR-300 | 65±5 | 10±0.5 | 90 | 88 | 255 | 500 |
| MGR0U2 | MGR-50-SS | 52±1 | 5±0.3 | 75 | 116 | 255 | 4000 |
| MGR0S2 | MGR-50-S | 52±1 | 5±0.3 | 75 | 45 | 255 | 1000 |
| MGR01U | MGR-100-SS | 52±1 | 5±0.3 | 75 | 70 | 255 | 1000 |
| MGR01S | MGR-100-S | 58±1 | 5±0.3 | 80 | 82 | 255 | 1000 |
| MGR02U | MGR-200-SS | 58±1 | 5±0.3 | 80 | 82 | 255 | 1000 |
| MGR02S | MGR-200-S | 58±1 | 5±0.3 | 80 | 82 | 255 | 1000 |
| MGR03U | MGR-300-SS | 58±1 | 5±0.3 | 80 | 82 | 255 | 1000 |
| MGR03S | MGR-300-S | 65±5 | 10±0.5 | 90 | 119 | 255 | 1000 |

Tape in Reel (编带卷装)



| Part No. 料号 | Type 类型 | Dimension of T/R (尺寸) (mm) | | | | Qty./Box 数量 / 盒 |
|---|------------|----------------------------|-----|-----|-----|--------------------|
| | | A | W±5 | H±5 | L±5 | |
| Carbon Film Fixed Resistors (碳膜固定电阻) | | | | | | |
| CFR0W8 | CFR-12 | 73±2 | 85 | 295 | 293 | 5,000 |
| CFR0S4 | CFR-25-S | 73±2 | 85 | 295 | 293 | 5,000 |
| CFR0W4 | CFR-25 | 73±2 | 85 | 295 | 293 | 5,000 |
| CFR0U2 | CFR-50-SS | 73±2 | 85 | 295 | 293 | 5,000 |
| CFR0S2 | CFR-50-S | 73±2 | 85 | 295 | 293 | 4,000 |
| CFR0W2 | CFR-50 | 73±2 | 85 | 295 | 293 | 4,000 |
| CFR01S | CFR-100-S | 73±2 | 85 | 295 | 293 | 2,500 |
| CFR0IW | CFR-100 | 80±5 | 95 | 295 | 293 | 1,000 |
| CFR02S | CFR-200-S | 80±5 | 95 | 295 | 293 | 1,000 |
| CFR02W | CFR-200 | 80±5 | 95 | 295 | 293 | 1,000 |
| CFR03S | CFR-300-S | 80±5 | 95 | 295 | 293 | 1,000 |
| Metal Film Fixed Resistors (金属膜固定电阻) | | | | | | |
| MFROW8 | MF-12 | 73±2 | 85 | 295 | 293 | 5,000 |
| MFROS4 | MF-25-S | 73±2 | 85 | 295 | 293 | 5,000 |
| MFROW4 | MF-25 | 73±2 | 85 | 295 | 293 | 5,000 |
| MFRO04 | MF-40-SS | 73±2 | 85 | 295 | 293 | 5,000 |
| MFROU2 | MF-50-SS | 73±2 | 85 | 295 | 293 | 5,000 |
| MFROS2 | MF-50-S | 73±2 | 85 | 295 | 293 | 4,000 |
| MFROW2 | MF-50 | 73±2 | 85 | 295 | 293 | 4,000 |
| MFRO06 | MF-60-S | 73±2 | 85 | 295 | 293 | 5,000 |
| MFROIW | MF-100 | 73±2 | 85 | 295 | 293 | 2,500 |
| MFRO2W | MF-200 | 80±5 | 95 | 295 | 293 | 1,000 |
| MFRO3W | MF-300 | 80±5 | 95 | 295 | 293 | 1,000 |
| Metal Oxide Film Fixed Resistors (金属氧化膜固定电阻) | | | | | | |
| MOROW4 | MOR-25 | 73±2 | 85 | 295 | 293 | 5,000 |
| MOR0S2 | MOR-50-S | 73±2 | 85 | 295 | 293 | 5,000 |
| MOROW2 | MOR-50 | 73±2 | 85 | 295 | 293 | 3,500 |
| MOR01S | MOR-100-S | 73±2 | 85 | 295 | 293 | 2,500 |
| MOR0IW | MOR-100 | 73±2 | 85 | 295 | 293 | 2,500 |
| MOR02S | MOR-200-S | 73±2 | 85 | 295 | 293 | 2,500 |
| MOR02W | MOR-200 | 80±5 | 95 | 295 | 293 | 1,000 |
| MOR03S | MOR-300-S | 80±5 | 95 | 295 | 293 | 1,000 |
| MOR03W | MOR-300 | 80±5 | 95 | 295 | 293 | 1,000 |
| MOR05U | MOR-500-SS | 80±5 | 95 | 295 | 293 | 1,000 |

| Part No. 料号 | Type 类型 | Dimension of T/R (尺寸) (mm) | | | | Qty./Box 数量 / 盒 |
|---|------------|----------------------------|-----|-----|-----|--------------------|
| | | A | W±5 | H±5 | L±5 | |
| Fusible Resistors (保险丝电阻) | | | | | | |
| FRNOW4 | FRN-25 | 73±2 | 85 | 295 | 293 | 5,000 |
| FRNOW2 | FRN-50 | 73±2 | 85 | 295 | 293 | 4,000 |
| FRNO1W | FRN-100 | 73±2 | 85 | 295 | 293 | 2,500 |
| FRNO2W | FRN-200 | 73±2 | 85 | 295 | 293 | 2,500 |
| FRNO3W | FRN-300 | 80±5 | 95 | 295 | 293 | 1,000 |
| Wire-wound Fixed Resistors (绕线固定电阻) | | | | | | |
| KNPOW2 | KNP-50 | 73±2 | 85 | 295 | 293 | 2,500 |
| KNP01S | KNP-100-S | 73±2 | 85 | 295 | 293 | 2,500 |
| KNP01W | KNP-100 | 73±2 | 85 | 295 | 293 | 2,500 |
| KNP02S | KNP-200-S | 73±2 | 85 | 295 | 293 | 2,500 |
| KNP02W | KNP-200 | 80±5 | 95 | 295 | 293 | 1,000 |
| KNP03S | KNP-300-S | 80±5 | 95 | 295 | 293 | 1,000 |
| KNP03W | KNP-300 | 80±5 | 95 | 295 | 293 | 1,000 |
| KNP05S | KNP-500-S | 80±5 | 95 | 295 | 293 | 1,000 |
| Jumper Wires & Zero-Ohm Resistors (跳线和零欧姆固定电阻) | | | | | | |
| ZWA0 | ZW-A | 73±2 | 85 | 295 | 293 | 10,000 |
| ZWB0 | ZW-B | 73±2 | 85 | 295 | 293 | 10,000 |
| ZO0W8 | ZO-12 | 73±2 | 85 | 295 | 293 | 5,000 |
| ZO0W4 | ZO-25 | 73±2 | 85 | 295 | 293 | 5,000 |

• Taping dimension are the same as Tape/Box packing (纸带尺寸与编带盒装尺寸相同)

Bulk in Box Packing (散装盒装)

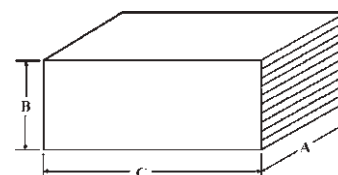
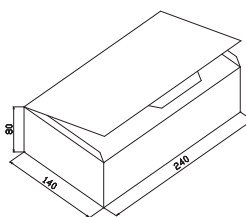

| Part No. 料号 | Type 类型 | Dimension of Bulk/Box (内盒尺寸) (mm) | | | Qty. of Bag/Box 袋数量 / 盒数量 |
|---|------------|-----------------------------------|-----|-----|------------------------------|
| | | A±5 | B±5 | C±5 | |
| Carbon Film Fixed Resistors (碳膜固定电阻) | | | | | |
| CFR0W8 | CFR-12 | 140 | 80 | 240 | 1,000 / 20,000 |
| CFR0S4 | CFR-25-S | 140 | 80 | 240 | 1,000 / 20,000 |
| CFR0W4 | CFR-25 | 140 | 80 | 240 | 500 / 10,000 |
| CFR0U2 | CFR-50-SS | 140 | 80 | 240 | 250 / 10,000 |
| CFR0S2 | CFR-50-S | 140 | 80 | 240 | 500 / 8,000 |
| CFR0W2 | CFR-50 | 140 | 80 | 240 | 250 / 5,000 |
| CFR01S | CFR-100-S | 140 | 80 | 240 | 100 / 2,500 |
| CFR01W | CFR-100 | 140 | 80 | 240 | 100 / 1,500 |
| CFR02S | CFR-200-S | 140 | 80 | 240 | 100 / 1,500 |
| CFR02W | CFR-200 | 140 | 80 | 240 | 100 / 1,000 |
| CFR03S | CFR-300-S | 140 | 80 | 240 | 100 / 1,000 |
| Metal Film Fixed Resistors (金属膜固定电阻) | | | | | |
| MFR0W8 | MF-12 | 140 | 80 | 240 | 1,000 / 20,000 |
| MFR0S4 | MF-25-S | 140 | 80 | 240 | 1,000 / 20,000 |
| MFR0W4 | MF-25 | 140 | 80 | 240 | 500 / 10,000 |
| MFR004 | MF-40-SS | 140 | 80 | 240 | 1,000 / 20,000 |
| MFR0U2 | MF-50-SS | 140 | 80 | 240 | 500 / 10,000 |
| MFR0S2 | MF-50-S | 140 | 80 | 240 | 500 / 8,000 |
| MFR0W2 | MF-50 | 140 | 80 | 240 | 250 / 2,000 |
| MFR006 | MF-60-S | 140 | 80 | 240 | 500 / 10,000 |
| MFR01W | MF-100 | 140 | 80 | 240 | 100 / 2,500 |
| MFR02W | MF-200 | 140 | 80 | 240 | 100 / 1,500 |
| MFR03W | MF-300 | 140 | 80 | 240 | 100 / 1,500 |
| Metal Oxide Film Fixed Resistors (金属氧化膜固定电阻) | | | | | |
| MOR0W4 | MOR-25 | 140 | 80 | 240 | 250 / 10,000 |
| MOR0S2 | MOR-50-S | 140 | 80 | 240 | 250 / 10,000 |
| MOR0W2 | MOR-50 | 140 | 80 | 240 | 200 / 4,000 |
| MOR01S | MOR-100-S | 140 | 80 | 240 | 200 / 4,000 |
| MOR01W | MOR-100 | 140 | 80 | 240 | 100 / 2,500 |
| MOR02S | MOR-200-S | 140 | 80 | 240 | 100 / 2,500 |
| MOR02W | MOR-200 | 140 | 80 | 240 | 100 / 1,500 |
| MOR03S | MOR-300-S | 140 | 80 | 240 | 100 / 1,500 |
| MOR03W | MOR-300 | 140 | 80 | 240 | 100 / 1,000 |
| MOR05U | MOR-500-SS | 140 | 80 | 240 | 100 / 1,000 |
| MOR05S | MOR-500-S | 140 | 80 | 240 | 25 / 400 |
| MOR05W | MOR-500 | 140 | 80 | 240 | 25 / 400 |
| MOR07W | MOR-700 | 140 | 80 | 240 | 25 / 300 |

| Part No. 料号 | Type 类型 | Dimension of Bulk/Box (内盒尺寸) (mm) | | | Qty. of Bag/Box 袋数量 / 盒数量 |
|--|------------|-----------------------------------|-----|-----|------------------------------|
| | | A±5 | B±5 | C±5 | |
| Fusible Resistors (保险丝电阻) | | | | | |
| FRN0W4 | FRN-25 | 140 | 80 | 240 | 250 / 10,000 |
| FRN0W2 | FRN-50 | 140 | 80 | 240 | 250 / 8,000 |
| FRN01W | FRN-100 | 140 | 80 | 240 | 200 / 4,000 |
| FRN02W | FRN-200 | 140 | 80 | 240 | 100 / 2,500 |
| FRN03W | FRN-300 | 140 | 80 | 240 | 100 / 1,500 |
| Wire-wound Fixed Resistors (绕线固定电阻) | | | | | |
| KNP0W2 | KNP-50 | 140 | 80 | 240 | 250 / 5,000 |
| KNP01S | KNP-100-S | 140 | 80 | 240 | 200 / 4,000 |
| KNP01W | KNP-100 | 140 | 80 | 240 | 100 / 2,500 |
| KNP02S | KNP-200-S | 140 | 80 | 240 | 100 / 2,500 |
| KNP02W | KNP-200 | 140 | 80 | 240 | 100 / 1,500 |
| KNP03S | KNP-300-S | 140 | 80 | 240 | 100 / 1,500 |
| KNP03W | KNP-300 | 140 | 80 | 240 | 100 / 1,000 |
| KNP05S | KNP-500-S | 140 | 80 | 240 | 25 / 400 |
| KNP05W | KNP-500 | 140 | 80 | 240 | 25 / 400 |
| Zero-Ohm Resistors (零欧姆固定电阻) | | | | | |
| ZO00W8 | ZO-12 | 140 | 80 | 240 | 1,000 / 20,000 |
| ZO00W4 | ZO-25 | 140 | 80 | 240 | 500 / 10,000 |
| CFR00W8 | CFR-12 | 140 | 80 | 240 | 1,000 / 20,000 |
| CFR00W4 | CFR-25 | 140 | 80 | 240 | 500 / 10,000 |

Feature (特性)

- Self-extinguishing 完全不可燃
- Extremely small & sturdy mechanically safe 体积小且坚固安全
- Non-Inductive type available 无感也可提供
- Excellent flame & moisture resistance 卓越抗湿性
- Too low or too high values on Wire-wound & Power-film type can be supplied on a case to case basis 过高或过低阻值，绕线或切割型都可以特别提供

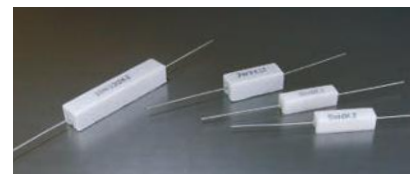

Derating Curve (降功率曲线)

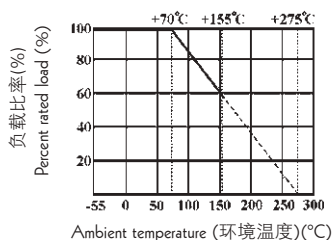

Heat Rise Chart (表面温升)

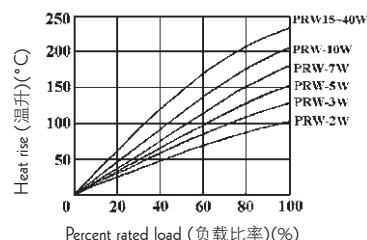

Axial Leaded Type - PRW Series (轴式导线型-PRW系列)

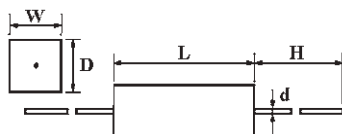

| Part No. 料号 | Type 类型 | Dimension (尺寸)(mm) | | | | | Resistance Range 阻值范围 | |
|----------------|------------|--------------------|-------|-------|------|----------|-----------------------|-------------------|
| | | W ± 1 | D ± 1 | L ± 1 | H | d ± 0.05 | Wire-wound 绕线型 | Power Film 切割型 |
| PRW01W | PRW-1W | 6 | 6 | 13.5 | 25±3 | 0.65 | 0.1Ω~20Ω | 21Ω~100KΩ |
| PRW02W | PRW-2W | 7 | 7 | 18 | 28±5 | 0.70 | 0.1Ω~27Ω | 28Ω~120KΩ |
| PRW03W | PRW-3W | 8 | 8 | 22 | 32±5 | 0.70 | 0.1Ω~39Ω | 40Ω~150KΩ |
| PRW05W | PRW-5W | 10 | 9 | 22 | 35±5 | 0.75 | 0.1Ω~47Ω | 48Ω~150KΩ |
| PRW07W | PRW-7W | 10 | 9 | 35 | 35±5 | 0.75 | 0.1Ω~680Ω | 681Ω~200KΩ |
| PRW0AW | PRW-10W | 10 | 9 | 49 | 35±5 | 0.75 | 0.1Ω~910Ω | 911Ω~200KΩ |
| PRW0FW | PRW-15W | 12.5 | 11.5 | 49 | 35±5 | 0.75 | 1Ω ~ 1KΩ | 1.1KΩ~200KΩ |
| PRW020 | PRW-20W | 14.5 | 13.5 | 60 | 35±5 | 0.75 | 2Ω ~ 1.2KΩ | 1.3KΩ~200KΩ |
| PRW025 | PRW-25W | 14.5 | 13.5 | 64 | 35±5 | 0.75 | 2Ω ~ 1.2KΩ | 1.3KΩ~200KΩ |

Axial Leaded Type - PRWC Series (轴式导线型-PRW系列)

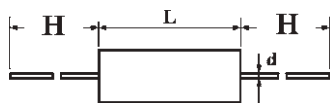

| Part No. 料号 | Type 类型 | Dimension (尺寸)(mm) | | | | | Resistance Range 阻值范围 | |
|----------------|------------|--------------------|-------|-------|--------|----------|-----------------------|-------------------|
| | | W ± 1 | D ± 1 | L ± 1 | H | d ± 0.05 | Wire-wound 绕线型 | Power Film 切割型 |
| PRWC3W | PRWC-3W | 6 | 6 | 20 | 28 ± 5 | 0.70 | 1Ω~27Ω | 28Ω~120KΩ |
| PRWC5W | PRWC-5W | 6 | 6 | 25 | 35 ± 5 | 0.75 | 1Ω~100Ω | 101Ω~150KΩ |
| PRWC7W | PRWC-7W | 9 | 9 | 25 | 35 ± 5 | 0.75 | 1Ω~100Ω | 101Ω~150KΩ |

Axial Leaded Type - PRWA Series (轴式导线型-PRWA系列)

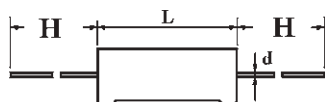

| Part No. 料号 | Type 类型 | Dimension (尺寸)(mm) | | | | | Resistance Range 阻值范围 | |
|----------------|------------|--------------------|-------|-------|--------|----------|-----------------------|-------------------|
| | | W ± 1 | D ± 1 | L ± 1 | H | d ± 0.05 | Wire-wound 绕线型 | Power Film 切割型 |
| PRWA2W | PRWA-2W | 7 | 7 | 18 | 28 ± 5 | 0.70 | 0.1Ω~27Ω | 28Ω~120KΩ |
| PRWA5W | PRWA-5W | 10 | 9 | 22 | 35 ± 5 | 0.75 | 0.1Ω~47Ω | 48Ω~150KΩ |
| PRWA7W | PRWA-7W | 10 | 9 | 35 | 35 ± 5 | 0.75 | 0.1Ω~680Ω | 681Ω~200KΩ |
| PRWAAW | PRWA-10W | 10 | 9 | 49 | 35 ± 5 | 0.75 | 0.1Ω~910Ω | 911Ω~200KΩ |

Radial Leaded Type-PRM series (立式导线型-PRM系列)



PRM2W PRM3W PRM5W PRMA-5W PRMP-5W
PRMP-7W PRMP-15W Leads centered (居中)

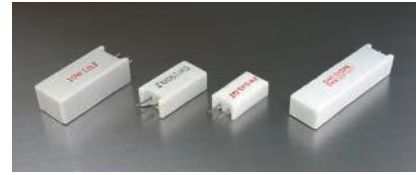

| Part No. 料号 | Type 类型 | Dimension (尺寸)(mm) | | | | | Resistance Range 阻值范围 | |
|----------------|------------|--------------------|-------|-------|-------|----------|-----------------------|----------------|
| | | W ± 1 | D ± 1 | L ± 1 | P ± 1 | d ± 0.05 | Wire-wound 绕线型 | Power Film 切割型 |
| PRM02W | PRM-2W | 11.5 | 7.5 | 20 | 5 | 0.70 | 0.1Ω~27Ω | 28Ω~120KΩ |
| PRM03W | PRM-3W | 12.5 | 8.5 | 25 | 5 | 0.70 | 0.1Ω~39Ω | 40Ω~150KΩ |
| PRM05W | PRM-5W | 12.5 | 9 | 25 | 5 | 0.75 | 0.1Ω~47Ω | 48Ω~150KΩ |
| PRM07W | PRM-7W | 12.5 | 9 | 38 | 5 | 0.75 | 0.1Ω~680Ω | 681Ω~200KΩ |
| PRM0AW | PRM-10W | 12.5 | 9 | 50 | 5 | 0.75 | 0.1Ω~910Ω | 911Ω~200KΩ |
| PRMA5W | PRMA-5W | 12.5 | 9 | 25 | 7.5 | 0.80 | 0.1Ω~47Ω | 48Ω~100KΩ |
| PRMAAW | PRMA-10W | 16 | 12 | 35 | 7.5 | 0.80 | 0.1Ω~560Ω | 561Ω~100KΩ |
| PRMB7W | PRMB-7W | 12.5 | 9 | 38 | 5 | 0.80 | 0.1Ω~680Ω | 681Ω~200KΩ |

Radial Terminal Type - PRMT Series

立式端片型 PRMT系列



| Part No. 料号 | Type 类型 | Dimension (尺寸)(mm) | | | | | Resistance Range 阻值范围 | |
|----------------|------------|--------------------|---------|-------|-------|----------|-----------------------|----------------|
| | | W ± 1 | D ± 0.5 | L ± 1 | P ± 1 | d ± 0.05 | Wire-wound 绕线型 | Power Film 切割型 |
| PRMT15W | PRMT-15W | 20 | 13 | 38 | 7.5 | 0.5 | 0.1Ω~560Ω | 561Ω~200KΩ |
| PRMT20W | PRMT-20W | 20 | 13 | 45 | 7.5 | 0.4 | | |

Radial Leaded Type - PRS Series

立式导线型 PRS系列

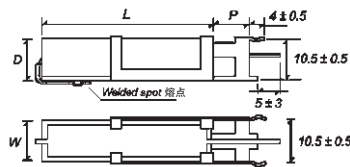

| Part No. 料号 | Type 类型 | Dimension (尺寸)(mm) | | | | Resistance Range 阻值范围 | |
|----------------|------------|--------------------|-------|-------|-------|-----------------------|----------------|
| | | W ± 1 | D ± 1 | L ± 1 | P ± 1 | Wire-wound 绕线型 | Power Film 切割型 |
| PRS05W | PRS-5W | 10 | 9 | 22 | 5 | 0.1Ω~47Ω | 48Ω~150KΩ |
| PRS07W | PRS-7W | 10 | 9 | 35 | 10 | 0.1Ω~680Ω | 681Ω~200KΩ |
| PRS0AW | PRS-10W | 10 | 9 | 49 | 10 | 0.1Ω~910Ω | 911Ω~200KΩ |
| PRS0FW | PRS-15W | 12.5 | 11.5 | 49 | 11 | 1Ω~1KΩ | 1.1KΩ~200KΩ |

Derating Curve (降功率曲线)

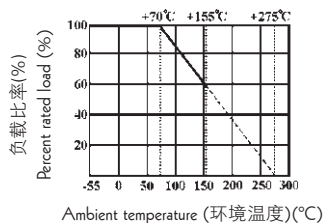

Heat Rise Chart (表面温升) (PRS)



Radial Terminal Type - PRVA Series

立式端片型-PRVA系列

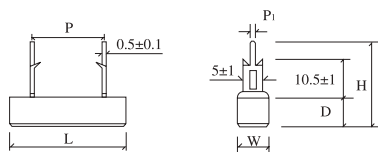

| Part No. 料号 | Type 类型 | Dimension (尺寸)(mm) | | | | | | Resistance Range 阻值范围 | |
|----------------|------------|--------------------|-------|---------|---------|----------------------|-------|-----------------------|----------------|
| | | W ± 1 | D ± 1 | L ± 1 | P ± 1 | P ₁ ± 0.2 | H ± 1 | Wire-wound 绕线型 | Power Film 切割型 |
| PRVA3W | PRVA-3W | 10 | 9 | 22 | 9.5 | 1.3 | 25 | 0.1Ω~47Ω | 48Ω~150KΩ |
| PRVA5W | PRVA-5W | 10 | 9 | 27 / 25 | 15/9.5 | 1.3 | 25 | 0.1Ω~120Ω | 121Ω~200KΩ |
| PRVA7W | PRVA-7W | 10 | 9 | 35 | 22 | 1.3 | 25 | 0.1Ω~560Ω | 561Ω~200KΩ |
| PRVAAW | PRVA-10W | 10 | 9 | 48 | 35 / 32 | 1.3 | 25 | 1Ω~820Ω | 821Ω~200KΩ |
| PRVAFW | PRVA-15W | 12.5 | 11.5 | 48 | 32 | 1.5 | 24 | 1Ω~1KΩ | 1.1KΩ~200KΩ |
| PRVA20 | PRVA-20W | 12.5 | 13.5 | 63 | 42 | 1.5 | 26 | 1Ω~1.2KΩ | 1.3KΩ~200KΩ |

Radial Terminal Type - PRVB Series

立式端片型-PRVB系列

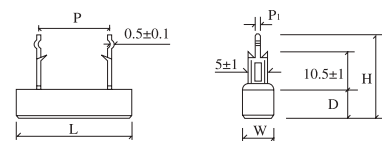

| Part No. 料号 | Type 类型 | Dimension (尺寸)(mm) | | | | | | Resistance Range 阻值范围 | |
|----------------|------------|--------------------|-------|---------|---------|----------------------|-------|-----------------------|----------------|
| | | W ± 1 | D ± 1 | L ± 1 | P ± 1 | P ₁ ± 0.2 | H ± 1 | Wire-wound 绕线型 | Power Film 切割型 |
| PRVB3W | PRVB-3W | 10 | 9 | 22 | 9.5 | 1.3 | 25 | 0.1Ω~47Ω | 48Ω~150KΩ |
| PRVB5W | PRVB-5W | 10 | 9 | 27 / 25 | 15/9.5 | 1.3 | 25 | 0.1Ω~120Ω | 121Ω~200KΩ |
| PRVB7W | PRVB-7W | 10 | 9 | 35 | 22 | 1.3 | 25 | 0.1Ω~560Ω | 561Ω~200KΩ |
| PRVBAW | PRVB-10W | 10 | 9 | 48 | 35 / 32 | 1.3 | 25 | 1Ω~820Ω | 821Ω~200KΩ |
| PRVBFW | PRVB-15W | 12.5 | 11.5 | 48 | 32 | 1.5 | 27.5 | 1Ω~1KΩ | 1.1KΩ~200KΩ |
| PRVB20 | PRVB-20W | 12.5 | 13.5 | 63 | 42 | 1.5 | 29.5 | 1Ω~1.2KΩ | 1.3KΩ~200KΩ |

Heat Rise Chart of PRVA & PRVB

PRVA & PRVB表面温升

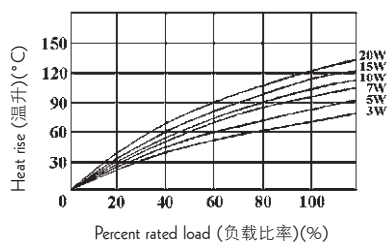

Radial Terminal Type - PRZ Series

立式端片型 PRZ 系列

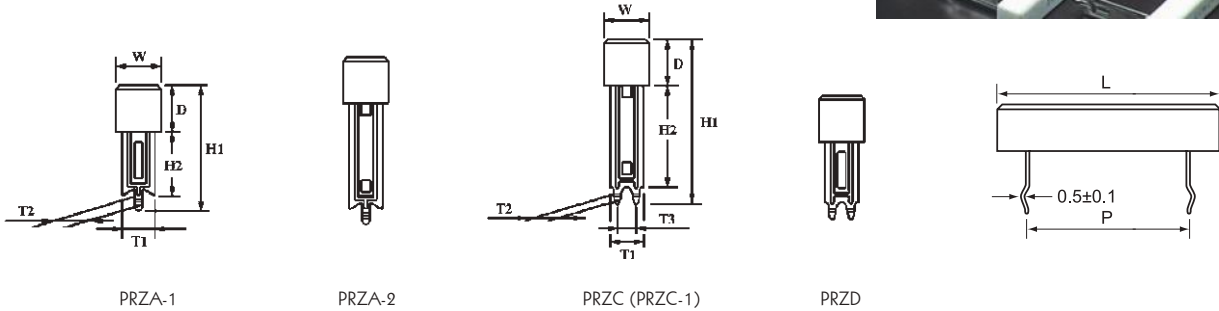

Dimension of Recommended Hole (参考尺寸孔径)(mm)

| Power Rating 功率 | PRZA-1, PRZA-2 | PRZC, PRZD | P |
|-----------------|----------------|------------|-----|
| 3W | | | 9.5 |
| 5W | | | 15 |
| 7W | | | 22 |
| 10W | | | 35 |
| 15W | | | 32 |
| 20W | | | 45 |

| Power Rating 功率 | Part No. 料号 | Type 类型 | Dimension 尺寸 (mm) | | | | | | | | | | Resistance Range 阻值范围 | | | |
|-----------------|-------------|---------|-------------------|------|-----------|--------|-------------------|---------------------|---------------------|--|--|----------------|-----------------------|-----------|-------------|--|
| | | | W±1 | D±1 | L | P±1.5 | T ₁ ±1 | T ₂ ±0.2 | T ₃ ±0.5 | H ₁ ⁺² ₋₁ | H ₂ ⁺² ₋₁ | Wire-wound 绕线型 | Power Film 切割型 | | | |
| 3W | PZ1A3W | PRZA-1 | | | | | | | | | | | | | | |
| | PZ2A3W | PRZA-2 | 10 | 9 | 22 ± 1 | 9.5 | 7 | 1.6 | - | | | 24 | 10 | 0.1Ω~47Ω | 48Ω~150KΩ | |
| | PRZC3W | PRZC | | | | | | 1.5 | | 3.5 | 36 | 22 | | | | |
| | PRZD3W | PRZD | | | | | | 1.3 | | | 24 | 10 | | | | |
| | | | | | | | | | | | | | | | | |
| 5W | PZ1A5W | PRZA-1 | | | 25/27 ± 1 | 9.5/15 | | 1.6 | - | | | 24 | 10 | 0.1Ω~120Ω | 121Ω~200KΩ | |
| | PZ2A5W | PRZA-2 | 10 | 9 | 27 ± 1 | 15 | 7 | 1.5 | | | | 36 | 22 | | | |
| | PRZC5W | PRZC | | | | | | 1.5 | | 3.5 | 39 | 24 | | | | |
| | PZ1C5W | PRZC-1 | | | | | | 1.3 | | | 24 | 10 | | | | |
| PRZD5W | PRZD | | | | | | | | | | | | | | | |
| 7W | PZ1A7W | PRZA-1 | | | | | | 1.6 | - | | | 24 | 10 | 0.1Ω~560Ω | 561Ω~200KΩ | |
| | PZ2A7W | PRZA-2 | 10 | 9 | 35 ± 1 | 22 | 7 | 1.5 | | | | 36 | 22 | | | |
| | PRZC7W | PRZC | | | | | | 1.5 | | 3.5 | 39 | 24 | | | | |
| | PZ1C7W | PRZC-1 | | | | | | 1.3 | | | 24 | 10 | | | | |
| PRZD7W | PRZD | | | | | | | | | | | | | | | |
| 10W | PZ1AAW | PRZA-1 | | | | | | 1.6 | - | | | 24 | 10 | 1Ω~820Ω | 821Ω~200KΩ | |
| | PZ2AAW | PRZA-2 | 10 | 9 | 48 ± 1.5 | 32/35 | 7 | 1.5 | | | | 39 | 25 | | | |
| | PRZCAW | PRZC | | | | | | 1.5 | | 3.5 | 36 | 22 | | | | |
| | PRZDAW | PRZD | | | | | | 1.3 | | | 24 | 10 | | | | |
| | | | | | | | | | | | | | | | | |
| 15W | PZ1AFW | PRZA-1 | | | | | | 3 | - | | | 35 | 15 | 1Ω~1KΩ | 1.1KΩ~200KΩ | |
| | PZ2AFW | PRZA-2 | 12.5 | 11.5 | 48 ± 1.5 | 32 | 10 | 2 | | | | 47 | 30 | | | |
| | PRZCFW | PRZC | | | | | | 2 | 5 | 47 | 30 | | | | | |
| | | | | | | | | | | | | | | | | |
| 20W | PZ1A20 | PRZA-1 | | | | | | 3 | - | | | 35 | 15 | 2Ω~1.2KΩ | 1.3KΩ~200KΩ | |
| | PZ2A20 | PRZA-2 | 12.5 | 13.5 | 63 ± 1.5 | 42 | 10 | 2 | | | | 47 | 30 | | | |
| PRZC20 | PRZC | 2 | | | | | | 5 | 47 | 30 | | | | | | |

Derating Curve (降功率曲线)

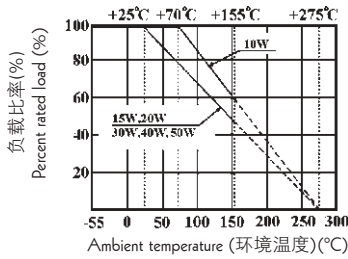

Heat Rise Chart (表面温升)

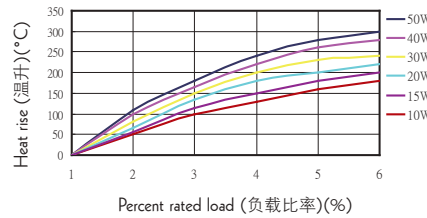

Radial Terminal Type - PRT (With metal mounting bracket)/PRU Series

立式端片型 PRT (带金属安装支架)/PRU

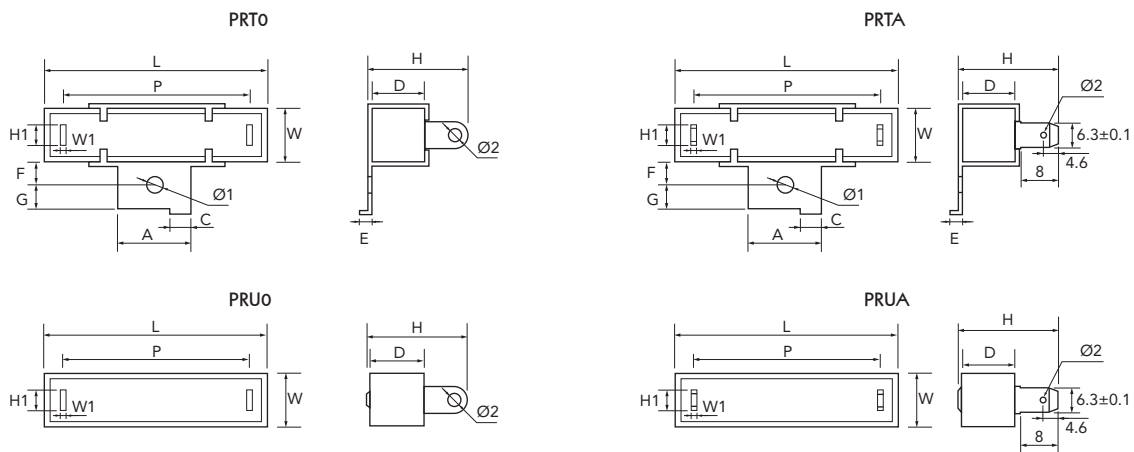

| Type 类型 | Dimension (尺寸)(mm) | | | | | | | | | | | | | Resistance Range 阻值范围 | | | |
|------------|--------------------|---------|------|------|---------|-----------|------------|-----------|-----------|-----------|---------|------------|------------|-----------------------|-------------------|-------------------|-------------|
| | W ±1 | D ±1 | L | P | H ±1 | A ±0.5 | H1 ±0.4 | C ±0.5 | F ±0.5 | G ±0.5 | E ±1 | Ø1 ±0.2 | Ø2 ±0.2 | W1 ±0.08 | Wire-wound 绕线型 | Power Film 切割型 | |
| 10W | PRT0/PRU0 | 10 | 9 | 48 | 32 | 18 | 12 | 5.5 | 3 | 8.7 | 5 | 3 | 4.1 | 2.5 | 0.5 | 1Ω~820Ω | 821Ω~200KΩ |
| | PRTA/PRUA | | | ±1.5 | ±1 | 19 | | 8.0 | | | | | 1.6 | 0.8 | | | |
| 15W | PRT0/PRU0 | 12.5 | 11.5 | 48 | 32 | 21 | 12 | 6.2 | 3 | 8.0 | 6 | 3 | 4.1 | 2.5 | 0.5 | 1Ω~1KΩ | 1.1KΩ~200KΩ |
| | PRTA/PRUA | | | ±1.5 | ±1 | 23.5 | | 7.6 | | | | | 1.6 | 0.8 | | | |
| 20W | PRT0/PRU0 | 12.5 | 13.5 | 63 | 44 | 21 | 12 | 6.2 | 3 | 10 | 6 | 3 | 4.1 | 2.5 | 0.5 | 2Ω~1.2KΩ | 1.3KΩ~200KΩ |
| | PRTA/PRUA | | | ±1.5 | ±1 | 25 | | 7.6 | | | | | 1.6 | 0.8 | | | |
| 30W | PRT0/PRU0 | 19 | 19 | 75 | 54 | 32 | 18 | 7.6 | 3 | 9.5 | 7.5 | 4 | 4.1 | 3.2 | 0.5 | 3Ω~1.5KΩ | / |
| | PRTA/PRUA | | | ±1.5 | ±1 | 30 | | 7.6 | | | | | 6.0 | 1.6 | 0.8 | | |
| 40W | PRT0/PRU0 | 19 | 19 | 90 | 70 | 32 | 18 | 7.6 | 3 | 9.5 | 7.5 | 4 | 4.1 | 3.2 | 0.5 | 6Ω~1.5KΩ | / |
| | PRTA/PRUA | | | ±1.5 | ±1 | 30 | | 8.0 | | | | | 6.0 | 1.6 | 0.8 | | |
| 50W | PRT0/PRU0 | 19 | 19 | 90 | 70 | 32 | 18 | 7.6 | 3 | 9.5 | 7.5 | 4 | 4.1 | 3.2 | 0.5 | 6Ω~1.5KΩ | / |
| | PRTA/PRUA | | | ±1.5 | ±1 | 30 | | 8.0 | | | | | 6.0 | 1.6 | 0.8 | | |

Performance Specifications (性能)

| | | |
|---------------------------------|--------|---|
| Operating temperature | 工作温度范围 | -55°C~+155°C |
| Temperature coefficient | 温度系数 | <20Ω: ±400PPM |
| | | ≥20Ω: ±350PPM |
| Short-time Overload | 短时间过负荷 | $\Delta R/R \leq \pm(5\%+0.05\Omega)$, with no evidence of mechanical damage (无可见机械损伤) |
| Dielectric withstanding voltage | 绝缘耐压 | No evidence of flashover, mechanical damage. (无击穿、飞弧及可见机械损伤) |
| Resistance to soldering heat | 耐焊接热 | $\Delta R/R \pm(1\%+0.05\Omega)$ with no evidence of mechanical damage (无可见机械损伤) |
| Temperature cycling | 温度循环 | $\Delta R/R \leq \pm(2\%+0.05\Omega)$, with no evidence of mechanical damage (无可见机械损伤) |
| Humidity (Steady State) | 恒定湿热 | $\Delta R/R \leq \pm(5\%+0.05\Omega)$, with no evidence of mechanical damage (无可见机械损伤) |
| Load life in humidity | 湿度寿命 | Wire-wound type (绕线型): $\leq R/R = \pm 5\%$; |
| | | Power Film type (切割型): <100KΩ: $\Delta R/R = \pm 5\%$; Power Film type (切割型): ≥100KΩ: $\Delta R/R = \pm 10\%$. |
| Load life | 负载寿命 | Wire-wound type (绕线型): $\Delta R/R = \pm 5\%$; |
| | | Power Film type (切割型): <100KΩ: $\Delta R/R = \pm 5\%$; Power Film type (切割型): ≥100KΩ: $\Delta R/R = \pm 10\%$. |

Ordering Procedure (Example: PRT 50W 5% 100Ω, B/B)

订购方式 (例如: PRT 50W 5% 100Ω, B/B)

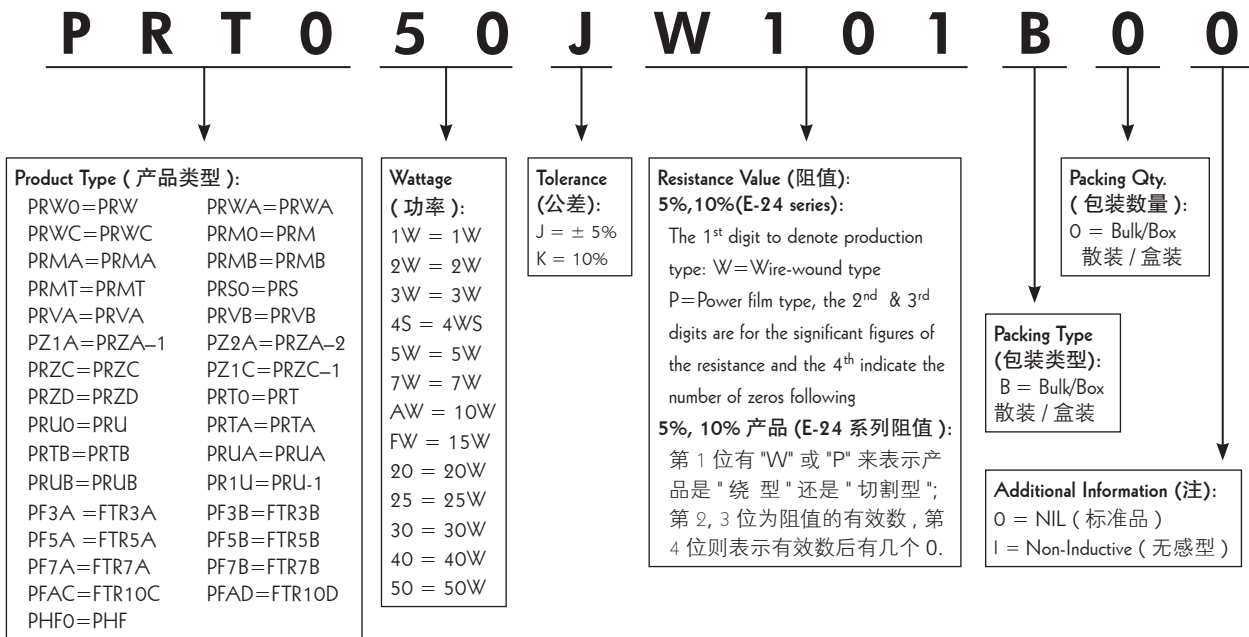

Derating Curve (降功率曲线)

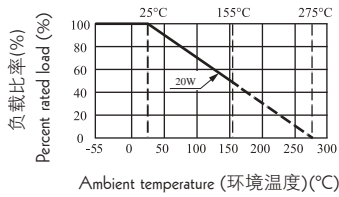

Heat Rise Chart (表面温升)

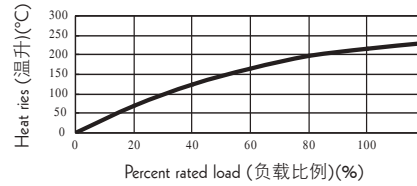

Dimension (尺寸)(mm)

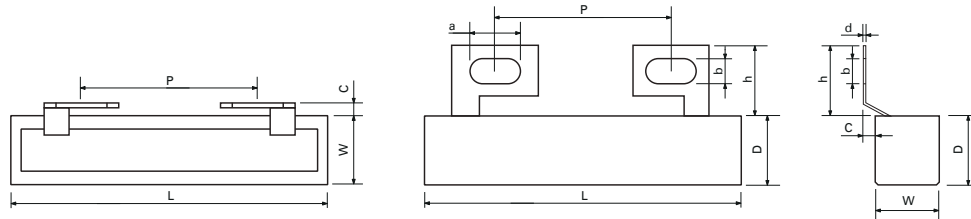

| Type 类型 | Dimension(尺寸)(mm) | | | | | | | | | Resistance Range 阻值范围 |
|------------|-------------------|-------|-------|-------|-------|-------|-------|-------|-------|--------------------------|
| | W±1.0 | D±1.5 | L±1.5 | P±1.5 | a±0.8 | b±0.5 | c±0.5 | d±0.1 | h±1.0 | Power Film 切割型 |
| PRTM20W | 12.5 | 13.5 | 63.0 | 35.0 | 10.0 | 5.0 | 2.5 | 0.8 | 14.0 | 1.3KΩ~200KΩ |

Specification (性能)

| | | |
|---------------------------------|--------|---|
| Operating temperature | 工作温度范围 | -55°C~+155°C |
| Temperature coefficient | 温度系数 | <20Ω: ±400PPM ≥20Ω: ±350PPM |
| Short-time Overload | 短时间过负荷 | ΔR/R ≤ ±(5%+0.05Ω), with no evidence of mechanical damage (无可见机械损伤) |
| Dielectric withstanding voltage | 绝缘耐压 | No evidence of flashover, mechanical damage. (无击穿、飞弧及可见机械损伤) |
| Resistance to soldering heat | 耐焊接热 | ΔR/R ±(1%+0.05Ω) with no evidence of mechanical damage (无可见机械损伤) |
| Temperature cycling | 温度循环 | ΔR/R ≤ ±(2%+0.05Ω), with no evidence of mechanical damage (无可见机械损伤) |
| Humidity (Steady State) | 恒定湿热 | ΔR/R ≤ ±(5%+0.05Ω), with no evidence of mechanical damage (无可见机械损伤) |
| Load life in humidity | 湿度寿命 | Wire-wound type (绕线型): ≤R/R = ±5%; |
| | | Power Film type (切割型): <100KΩ: ΔR/R = ±5%; Power Film type (切割型): ≥100KΩ: ΔR/R = ±10%. |
| Load life | 负载寿命 | Wire-wound type (绕线型): ΔR/R = ±5%; |
| | | Power Film type (切割型): <100KΩ: ΔR/R = ±5%; Power Film type (切割型): ≥100KΩ: ΔR/R = ±10%. |

Ordering Procedure (Example: PRTM 20W 5% 1.3KΩ, B/B)

订购方式 (例如: PRTM 20W 5% 1.3KΩ, B/B)

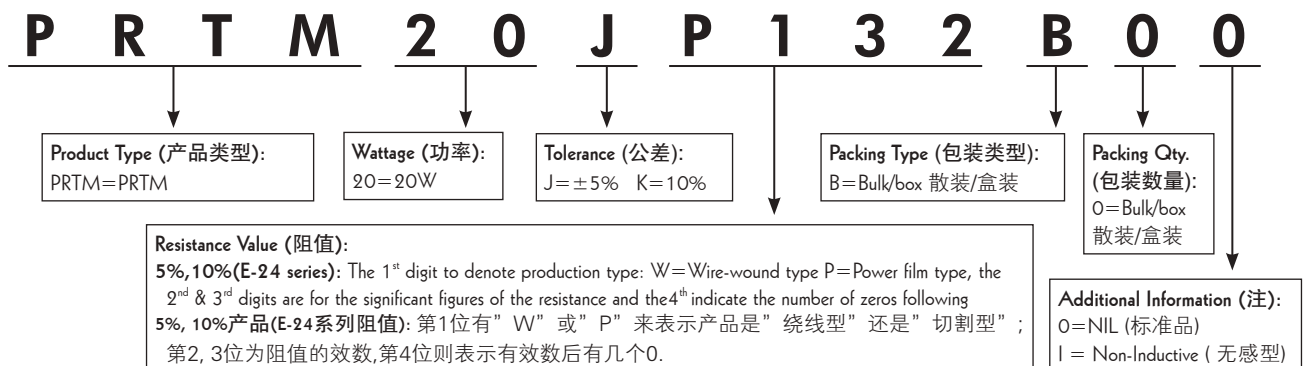

Leaded Type Cement Thermal Fusing Resistors - FTR Series
立式导线型保险丝电阻 FTR系列

Derating Curve
降功率曲线

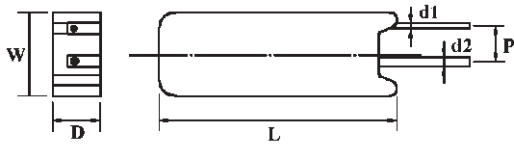

*FTR3A, FTR3B, FTR5A, FTR5B, FTR10C: leads centered (居中)

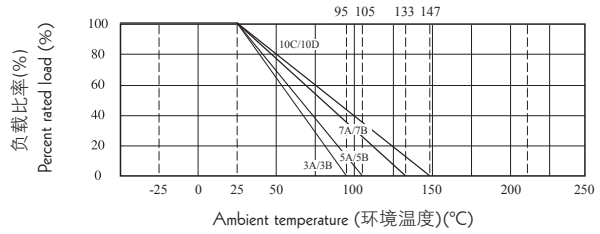

| Part No. 料号 | Type 类型 | Power Rating 功率 | Dimension (尺寸)(mm) | | | | | | Cut-Off Temperature 熔断温度 | Rated Current 额定电流 | Rated Voltage 额定电压 | Tolerance 公差 | Resistance Range 阻值范围 | |
|----------------|------------|--------------------|--------------------|-----|--|----------------------|-----|------|-----------------------------|-----------------------|-----------------------|------------------|-----------------------|-------------------|
| | | | D±1 | L±1 | d ₁ ^{+0.02} _{-0.05} | d ₂ ±0.05 | P±1 | W±1 | | | | | Wire-wound 绕线型 | Power Film 切割型 |
| PF3A00 | FTR3A | 1.5W | 8.5 | 25 | 0.5 | 0.70 | 5 | 12.5 | 130±4°C | | | | 1Ω-27Ω | 28Ω~120KΩ |
| PF3B00 | FTR3B | 2W | | | | | | | 145±4°C | | | | | |
| PF5A00 | FTR5A | 1.6W | 9 | 25 | 0.5 | 0.75 | 5 | 12.5 | 130±4°C | 2A | 250V | ±5% & ±10% | 1Ω-39Ω | 40Ω-120KΩ |
| PF5B00 | FTR5B | 2.1W | | | | | | | 145±4°C | | | | | |
| PF7A00 | FTR7A | 2.2W | 9 | 38 | 0.5 | 0.75 | 5 | 12.5 | 130±4°C | | | | 1Ω-47Ω | 48Ω-150KΩ |
| PF7B00 | FTR7B | 2.7W | | | | | | | 145±4°C | | | | | |
| PFAC00 | FTR10C | 3.5W | 12 | 35 | 1 | 0.75 | 7.5 | 16.5 | 188+3/-1°C | 10A | 250V | | 1Ω-47Ω | 48Ω-150KΩ |
| PFADAW | FTR-10D | 10W | 12 | 35 | 1 | 1.00 | 7.5 | 16.5 | 235±3°C | 10A | 250V | ±10% | 1Ω-120Ω | 121Ω-200KΩ |

Leaded Type Cement Thermal Fusing Resistors - PHF Series
立式弹片型保险丝电阻PHF系列

Derating Curve
降功率曲线

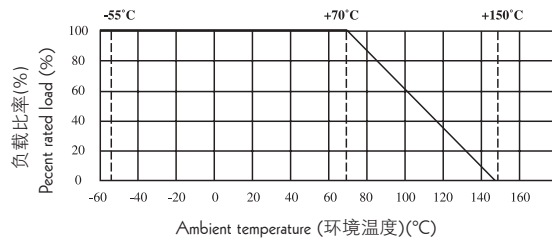
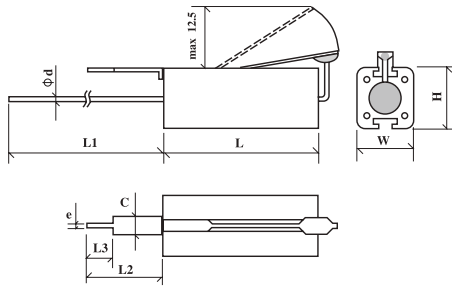

| Part No. 料号 | Type 类型 | Dimension (尺寸)(mm) | | | | | | | | | Resistance Range 阻值范围 (Wire-wound) (绕线型) | Cut-Off Temperature 熔断温度 |
|----------------|------------|--------------------|-------|-------|--------|--------|--------|-------|-------|---------|---|-----------------------------|
| | | L±1.0 | W±1.0 | H±1.0 | L1±3.0 | L2±1.5 | L3±0.5 | C±0.1 | e±0.1 | Ød±0.05 | | |
| PHF02W | PHF-2W | 25 | 9 | 10 | 38 | 13.0 | 4.5 | 3.0 | 0.9 | 0.75 | 1Ω~470Ω | 150±20°C |

PHF1 & PHF2 Series

水泥型电阻器PHF1及PHF2系列

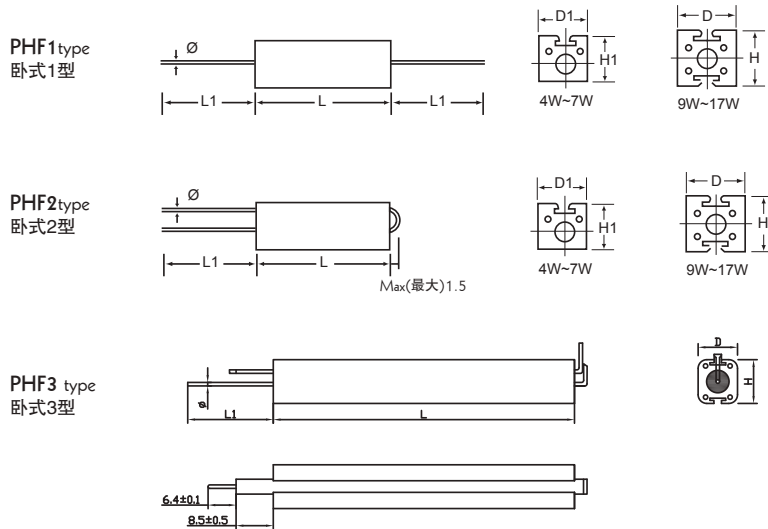

Dimension (外形尺寸)(mm)

| Part No. 料号 | Wattage 功率 | H±1.5 | H1±0.5 | D±0.5 | D1±0.5 | L | L1±3 | Ø±0.05 | Resistance Range 阻值范围 | Remark 备注 |
|----------------|---------------|-------|--------|-------|--------|------|------|--------|--------------------------|---|
| PHF1 4W | 4W | / | 8.5 | / | 7.5 | 20±1 | 30 | 0.75 | 1Ω~1KΩ | the leads could be specially designed according to customer's requirement |
| PHF2 4W | | | | | | | | | | |
| PHF1 5W | 5W | / | 8.5 | / | 7.5 | 25±1 | 30 | 0.75 | 1Ω~2.2KΩ | |
| PHF2 5W | | | | | | | | | | |
| PHF1 7W | 7W | / | 9.5 | / | 7.5 | 38±1 | 30 | 0.75 | 1Ω~6.2KΩ | |
| PHF2 7W | | | | | | | | | | |
| PHF1 9W | 9W | 10 | / | 9 | / | 38±1 | 30 | 0.75 | 1Ω~6.2KΩ | |
| PHF2 9W | | | | | | | | | | |
| PHF1 11W | 11W | 10 | / | 9 | / | 50±1 | 30 | 0.75 | 1Ω~6.2KΩ | |
| PHF2 11W | | | | | | | | | | |
| PHF3 11W | 11W | 10 | / | 9 | / | 50±1 | 10 | 0.75 | 引出线可根据客户的要求特别定做 | |
| PHF1 17W | 17W | 10 | / | 9 | / | 75±2 | 30 | 0.75 | 1Ω~10KΩ | |
| PHF2 17W | | | | | | | | | | |
| PHF3 17W | 17W | 10 | / | 9 | / | 75±2 | 10 | 0.75 | | |

Performance Specifications (性能)

| | | |
|---------------------------------|--------|---|
| Rated Power | 额定功率 | 4W~17W |
| Tolerance | 公差 | J(±5%) K(±10%) |
| Temperature coefficient | 温度系数 | ±350ppm/°C |
| Short-time overload | 短时间过负荷 | $\Delta R/R \leq \pm(3\%+0.05\Omega)$, with no evidence of mechanical damage (无可见机械损伤) |
| Dielectric withstanding voltage | 绝缘耐压 | No evidence of flashover, mechanical damage.(2000V) [无击穿、飞弧及可见机械损伤.(2000V)] |
| Terminal strength | 端子强度 | No evidence of mechanical damage (无可见机械损伤) |
| Soldering heat | 耐焊接热 | $\Delta R/R < \pm(1\%+0.05\Omega)$,with no evidence of mechanical damage (无可见机械损伤) |
| Load life | 负载寿命 | $\Delta R/R \leq \pm 5\%$,with no evidence of mechanical damage (无可见机械损伤) |

Feature (特性)

- Alloy material & low-inductive 合金材料，低感量
- Working stably under high current 大电流下可稳定工作
- Excellent temperature & moisture resistance 良好的耐温性和耐湿性

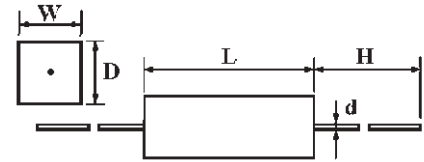

Dimension (尺寸) (mm)

| Part No. 料号 | Type 类型 | W±1 | D±1 | L±1 | H±5 | Ød±0.05 | Rated Current 额定电流 | Resistance Range 阻值范围 |
|----------------|------------|------|------|------|------|---------|-----------------------|--------------------------|
| PRWUAW | PRWU 10W | 10.0 | 9.0 | 49.0 | 35.0 | 0.80 | 30A | 0.01Ω~0.02Ω |
| PRWU15 | PRWU 15W | 12.5 | 11.5 | 49.0 | 35.0 | 1.00 | 40A | 0.01Ω~0.039Ω |
| PRWU20 | PRWU 20W | 14.5 | 13.5 | 60.0 | 35.0 | 1.00 | 40A | 0.01Ω~0.039Ω |
| PRWU25 | PRWU 25W | 14.5 | 13.5 | 64.0 | 35.0 | 1.00 | 40A | 0.01Ω~0.051Ω |

Performance Specifications (性能)

| | |
|---------------------------------|---|
| Temperature coefficient 温度系数 | ±300PPM/°C |
| Load life in humidity 湿度寿命 | ΔR/R ≤ ±(5.0%+0.05Ω), with no evidence of mechanical damage (无可见机械损伤) |
| Solderability 可焊性 | Min. 95% coverage (最少95%覆盖率) |
| Temperature cycling 温度循环 | ΔR/R ≤ ±(2.0%+0.05Ω), with no evidence of mechanical damage (无可见机械损伤) |
| Load life 负载寿命 | ΔR/R ≤ ±(5.0%+0.05Ω), with no evidence of mechanical damage (无可见机械损伤) |

Feature (特性)

- Low inductance 低电感量
- Safety flameproof construction 耐高温
- Thin & lightweight body save the PCB space considerably 体积小轻薄, 节省PCB空间
- Automatically insertable 可自动插件

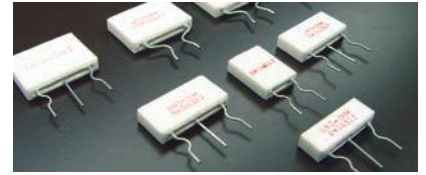

PFAS (Single Circuit) Dimension (mm)

PFAS (单电路) 尺寸(mm)

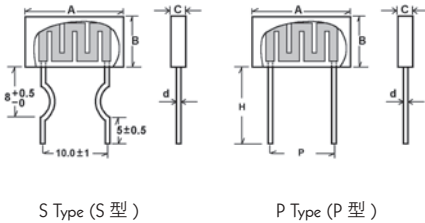

| Part No. 料号 | Type 类型 | Power Rating 功率 70°C | Dimension (尺寸)(mm) | | | | | Resistance Range 阻值范围 (5% & 10%) |
|----------------|------------|----------------------------|--------------------|-------|-------|--------|--------|--|
| | | | A±0.5 | B±0.5 | C±0.5 | d±0.05 | P±1.0 | |
| PFAS2W | PFAS 2W | 2W | 13.0 | 8.5 | 5.0 | 0.75 | | 0.01Ω~1Ω |
| PFAS3W | PFAS 3W | 3W | 13.0 | 13.5 | 5.0 | 0.75 | 10 | 0.01Ω~1Ω |
| PFAS5W | PFAS 5W | 5W | 14.0 | 18.0 | 5.0 | 0.75 | 4 & 10 | 0.01Ω~1Ω |
| PFASAW | PFAS 10W | 10W | 26.0 | 18.0 | 5.0 | 1.00 | 20 | 0.01Ω~3.3Ω |

PFAT (Twin Circuit) Dimension (mm)

PFAT (双电路) 尺寸(mm)

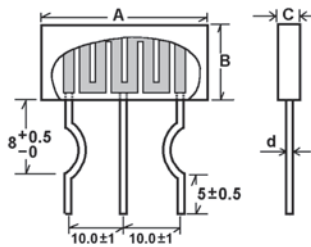

| Part No. 料号 | Type 类型 | Power Rating 功率 70°C | Dimension (尺寸)(mm) | | | | Resistance Range 阻值范围 (5% & 10%) |
|----------------|------------|----------------------------|--------------------|-------|-------|--------|--|
| | | | A±0.5 | B±0.5 | C±0.5 | d±0.05 | |
| PFAT2W | PFAT 2W+2W | 2W | 26.0 | 9.0 | 5.0 | 0.75 | 0.05Ω~1Ω |
| PFAT3W | PFAT 3W+3W | 3W | 26.0 | 13.0 | 5.0 | 0.75 | 0.05Ω~1Ω |
| PFAT5W | PFAT 5W+5W | 5W | 26.0 | 18.0 | 5.0 | 0.75 | 0.05Ω~1Ω |
| PFAT7W | PFAT 7W+7W | 7W | 26.0 | 20.0 | 5.0 | 1.00 | 0.1Ω~1Ω |

Heat Rise Chart (PFAS)

表面温升(PFAS)

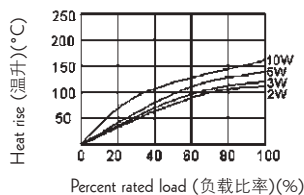

Heat Rise Chart (PFAT)

表面温升(PFAT)

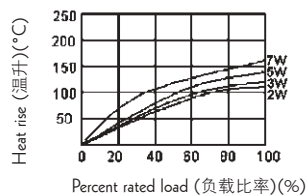

Derating Curve

降功率曲线

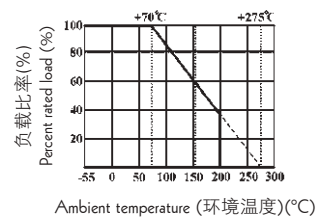

Performance Specifications (性能)

| | | |
|---------------------------------|--------|--|
| Temperature coefficient | 温度系数 | 0.01Ω~0.1Ω Please contact uniohm (请联系 UNIOHM) >0.1Ω: ≤±350PPM/°C |
| Short-time overload | 短时间过负荷 | ΔR/R ≤ ±2%, with no evidence of mechanical damage (无可见机械损伤) |
| Dielectric withstanding voltage | 绝缘耐压 | 2,000V |
| Operating temperature | 工作温度范围 | -55°C ~ +200°C |
| Terminal strength | 端子强度 | No evidence of mechanical damage (无可见机械损伤) |
| Soldering heat | 耐焊接热 | ΔR/R ≤ ±1%, with no evidence of mechanical damage (无可见机械损伤) |
| Solderability | 可焊性 | Min. 95% coverage (最少 95% 覆盖率) |
| Resistance to solvent | 耐溶剂 | No deterioration of protective coating and markings (包封层, 色码完整) |
| Temperature cycling | 温度循环 | ΔR/R ≤ ±5%, with no evidence of mechanical damage (无可见机械损伤) |
| Humidity (Steady State) | 恒定湿热 | ΔR/R ≤ ±5%, with no evidence of mechanical damage (无可见机械损伤) |
| Load life in humidity | 湿度寿命 | ΔR/R ≤ ±5%, with no evidence of mechanical damage (无可见机械损伤) |
| Load life | 负载寿命 | ΔR/R ≤ ±5%, with no evidence of mechanical damage (无可见机械损伤) |

Ordering Procedure (Example: PFAS 5W 5% 0.68Ω, B/B)

订购方式(例如: PFAS 5W 5% 0.68Ω, B/B)

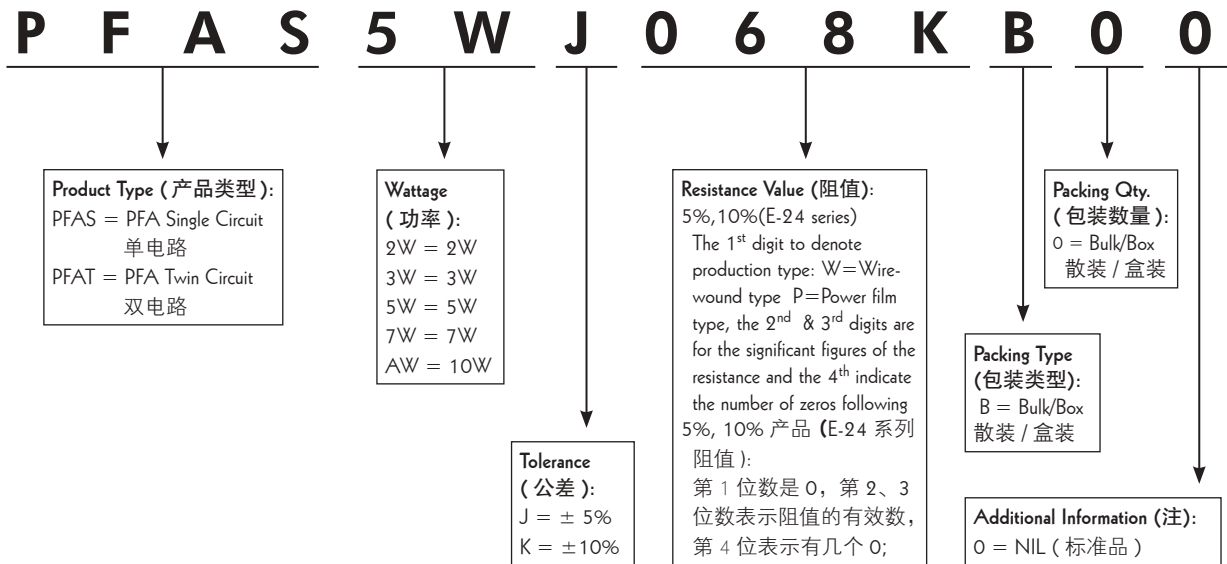



Dimension (外形尺寸) (mm)

| Type 料号 | L±1 | L1±3 | ØD±1 | Ød±0.05 | Resistance Range 阻值范围 | Remark 备注 |
|------------|-----|------|------|---------|--------------------------|---|
| QHO4W | 43 | 30 | 8 | 0.8 | 1Ω~6.2KΩ | the leads can be specially designed according to customer's requirement |
| QHO5W | 45 | 30 | 8 | 0.8 | | |
| QHO7W | 50 | 30 | 9 | 0.8 | | |
| QHO9W | 60 | 30 | 9 | 0.8 | 1Ω~10KΩ | 引出线可根据客户的要求特别定做 |
| QHO11W | 65 | 30 | 9 | 0.8 | | |
| QHO17W | 75 | 30 | 9 | 0.8 | | |

The resistor of same Wattage QHO-1 & QHO-2 are same, only the lead type is different.

同功率的QHO-1型和QHO-2型仅引出线方式不同,电阻体本身相同。

Performance Specifications (性能)

| | | |
|-------------------------|--------|--|
| Tolerance | 阻值精度 | J(±5%) K(±10%) |
| Temperature coefficient | 温度系数 | <20Ω:±400ppm/°C, ≥20Ω:±350ppm/°C |
| Short-time overload | 短时间过负荷 | R/R ≤ ±(5%+0.05Ω), with no evidence of mechanical damage (无可见机械损伤) |
| Terminal strength | 端子强度 | No evidence of mechanical damage (无可见机械损伤) |
| Soldering heat | 耐焊接热 | R/R ≤ ±(1%+0.05Ω), with no evidence of mechanical damage (无可见机械损伤) |
| Solderability | 可焊性 | Min. 95% coverage (最少95%覆盖率) |
| Temperature cycling | 温度循环 | R/R ≤ ±(2%+0.05Ω), with no evidence of mechanical damage (无可见机械损伤) |
| Humidity (Steady State) | 恒定湿热 | R/R ≤ ±(5%+0.05Ω), with no evidence of mechanical damage (无可见机械损伤) |
| Load life | 负载寿命 | R/R ≤ ±5%, with no evidence of mechanical damage (无可见机械损伤) |

Plastic Bag Packing [A 型包装 (塑料袋式包装)]

Inner Box of Plastic Bag Packing (内盒塑料袋式包装)

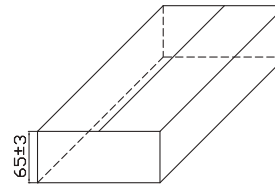

| Part NO. 料号 | Type 类型 | Qty. Per Bag/Box 袋 / 盒 数量 | Qty. per Carton 数量 (箱) | Carbon Dimention 外箱尺寸 (±5mm) | GW 毛重 (±2kg) |
|----------------------------|------------|------------------------------|-----------------------------|---------------------------------|-----------------|
| PRW Series (PRW 系列) | | | | | |
| PRW02W | PRW 2W | 10 / 600 | 3,600 | 547 x 215 x 245 | 12.5 |
| PRW03W | PRW 3W | 10 / 500 | 3,000 | | 14 |
| PRW05W | PRW 5W | 10 / 400 | 2,400 | | 14.5 |
| PRW07W | PRW 7W | 10 / 300 | 1,800 | | 17 |
| PRW0AW | PRW 10W | 10 / 250 | 1,500 | | 18 |
| PRW0FW | PRW 15W | 10 / 140 | 840 | | 16.5 |
| PRW020 | PRW 20W | 10 / 120 | 720 | | 21 |
| PRWA2W | PRWA 2W | 10 / 600 | 3,600 | | 12.5 |
| PRWA5W | PRWA 5W | 10 / 400 | 2,400 | | 14.5 |
| PRWA7W | PRWA 7W | 10 / 300 | 1 800 | | 17 |
| PRWAAW | PRWA 10W | 10 / 250 | 1 500 | | 18 |
| PRWC3W | PRWC 3W | 10 / 600 | 3,600 | | 12.5 |
| PRWC5W | PRWC 5W | 10 / 600 | 3,600 | | 14 |
| PRWC7W | PRWC 7W | 10 / 400 | 2,400 | | 16 |
| PRS Series (PRS 系列) | | | | | |
| PRS05W | PRS 5W | 10 / 400 | 2,400 | 547 x 215 x 245 | 18 |
| PRS07W | PRS 7W | 10 / 300 | 1,800 | | 17 |
| PRS0AW | PRS 10W | 10 / 250 | 1,500 | | 22 |
| PRT Series (PRT 系列) | | | | | |
| PRT0AW | PRT 10W | 10 / 200 | 1,200 | 547 x 215 x 245 | 20 |
| PRT0FW | PRT 15W | 10 / 120 | 720 | | 18 |
| PRT020 | PRT 20W | 10 / 90 | 540 | | 17.5 |
| PRT030 | PRT 30W | 5 / 45 | 270 | | 22 |
| PRT040 | PRT 40W | 5 / 25 | 150 | | 14.2 |
| PRT050 | PRT 50W | 5 / 25 | 150 | | 14.2 |
| PRU Series (PRU 系列) | | | | | |
| PRU0AW | PRU 10W | 10 / 200 | 1,200 | 547 x 215 x 245 | 14 |
| PRU0FW | PRU 15W | 10 / 160 | 960 | | 18.5 |
| PRU020 | PRU 20W | 10 / 90 | 540 | | 15 |
| PRU030 | PRU 30W | 5 / 60 | 360 | | 24 |
| PRU040 | PRU 40W | 5 / 50 | 300 | | 24.5 |
| PRU050 | PRU 50W | 5 / 50 | 300 | | 24.5 |

Poly-Foam Packing [B 型包装 (泡沫盒)]

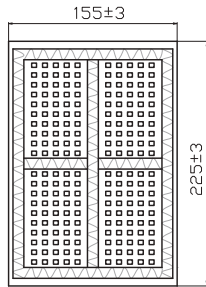

Inner Box of Poly-Foam Packing (泡沫内盒式包装)

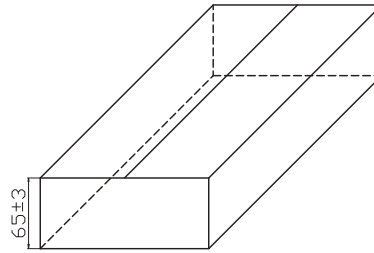

| Part NO. 料号 | Type 类型 | Qty. per Box 数量 (盒) | Qty. per Carton 数量 (箱) | Carton Dimension 外箱尺寸 (± 5mm) | GW 毛重 (± 2kg) |
|----------------------------|--------------|------------------------|---------------------------|----------------------------------|------------------|
| PRV Series (PRV 系列) | | | | | |
| PRVA3W | PRVA 3W | 200 | 2,000 | 440 x 255 x 195 | 16.5 |
| PRVA5W (6W) | PRVA 5W (6W) | 200 | 2,000 | 510 x 315 x 230 | 17.5 |
| PRVA7W | PRVA 7W | 100 | 1,000 | 373 x 219 x 240 | 13.5 |
| PRVAAW | PRVA 10W | 100 | 1,200 | 445 x 275 x 225 | 20 |
| PRVAFW | PRVA 15W | 100 | 1,000 | 509 x 281 x 191 | 20 |
| PRVA20 | PRVA 20W | 75 | 684 | 445 x 275 x 45 | 18 |
| PRVB3W | PRVB 3W | 200 | 2,000 | 510 x 315 x 230 | 16.3 |
| PRVB5W (6W) | PRVB 5W (6W) | 200 | 2,000 | 510 x 315 x 230 | 17.5 |
| PRVB7W | PRVB 7W | 100 | 1,200 | 373 x 219 x 240 | 16.5 |
| PRVBAW | PRVB 10W | 100 | 1,200 | 445 x 275 x 45 | 20 |
| PRVBFW | PRVB 15W | 100 / 1,000 | 100 / 1,000 | 611 x 312 x 307 | 20 |
| PRVB20 | PRVB 20W | 100 / 700 | 100 / 700 | 611 x 312 x 307 | 18.6 |
| PRZ Series (PRZ 系列) | | | | | |
| PZ1A5W | PRZA-1 5W | 200 | 2,000 | 510 x 315 x 230 | 17.5 |
| PZ2A5W | PRZA-2 5W | 200 | 1,600 | 510 x 315 x 230 | 14 |
| PRZC5W | PRZC 5W | 200 | 1,600 | 510 x 315 x 230 | 14 |
| PZ1C5W | PRZC-1 5W | 200 | 2,000 | 510 x 315 x 230 | 17.5 |
| PRZD5W | PRZD 5W | 200 | 2,000 | 510 x 315 x 230 | 17.5 |
| PZ1A7W | PRZA-1 7W | 100 | 1,000 | 373 x 219 x 240 | 16.5 |
| PZ2A7W | PRZA-2 7W | 100 | 1,000 | 470 x 305 x 280 | 6 |
| PRZC7W | PRZC 7W | | | | |
| PZ1C7W | PRZC-1 7W | 100 | 1,000 | 373 x 219 x 240 | 16.5 |
| PRZD7W | PRZD 7W | | | | |
| PZ1AAW | PRZA-1 10W | 100 | 1,200 | 445 x 275 x 415 | 20 |
| PZ2AAW | PRZA-2 10W | 100 | 1,000 | 470 x 305 x 280 | 16.3 |
| PRZCAW | PRZC 10W | 100 | 1,000 | 450 x 315 x 268 | 16.3 |
| PRZDAW | PRZD 10W | 100 | 1,200 | 445 x 275 x 415 | 20 |
| PZ1AFW | PRZA-1 15W | 100 | 800 | 509 x 191 x 281 | 16 |
| PZ2AFW | PRZA-2 15W | 100 | 800 | 509 x 239 x 281 | 16 |
| PRZCFW | PRZC 15W | 12.5 / 100 | 800 | 535 x 281 x 289 | 16 |
| PZ1A20 | PRZA-1 20W | 18.6 / 57 | 684 | 445 x 275 x 415 | 20 |
| PZ2A20 | PRZA-2 20W | 64 / 320 | 640 | 540 x 325 x 275 | 17 |
| PRZC20 | PRZC 20W | 100 | 600 | 533 x 351 x 336 | 16 |

Plastic Case Packing [C 型包装 (塑料格板)]

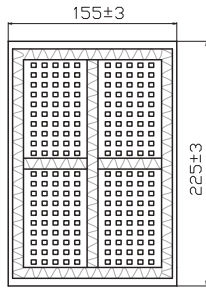

| Part No. 料号 | Type 类型 | Case Type 包装类型 | Box Dimension 内盒尺寸 (±5mm) | | | Qty. per Box 数量 (内盒) | Qty. per Carton 数量 (箱) | Carton Dimension 外箱尺寸 (± 5mm) | GW 毛重 (±2kg) |
|----------------------------|------------|-------------------|---------------------------|----|-----|-------------------------|---------------------------|----------------------------------|-----------------|
| | | | A | B | C | | | | |
| PRM Series (PRM 系列) | | | | | | | | | |
| PRM02W | PRM 2W | 67-A | 185 | 35 | 130 | 200 | 3,000 | 465 x 235 x 245 | 13 |
| PRM03W | PRM 3W | 67-A | 185 | 35 | 130 | 200 | 3,000 | 465 x 235 x 245 | 20.5 |
| PRM05W | PRM 5W | 41-A | 225 | 40 | 155 | 200 | 2,000 | 330 x 245 x 235 | 14 |
| PRMA5W | PRMA 5W | 41-A | 225 | 40 | 155 | 200 | 2,000 | 330 x 245 x 235 | 14 |
| PRMB5W | PRMB 5W | | | | | | | | |
| PRM07W | PRM 7W | 83-A | 218 | 55 | 165 | 200 | 1,200 | 535 x 235 x 135 | 13.5 |
| PRMB7W | PRMB 7W | | | | | | | | |
| PRM0AW | PRM 10W | 45-A | 225 | 65 | 155 | 200 | 1,200 | 414 x 307 x 196 | 17.5 |
| PRMAAW | PRMA 10W | 73-A | 165 | 49 | 137 | 100 | 2,000 | 290 x 232 x 238 | 32 |
| PRMBAW | PRMB 10W | 72-A | 300 | 35 | 24 | 200 | 1,200 | 460 x 230 x 155 | 17.2 |

Feature (特性)

- With Aluminum Shell for a good heat dissipation, suitable for board mount
铝外壳散热性能好, 适用于散热板安装
- Thin & lightweight body with big power rating 本体小而轻, 功率大
- Low inductance 低感量
- Application: Power Supply, Adapter, Machine 应用: 设备电源类

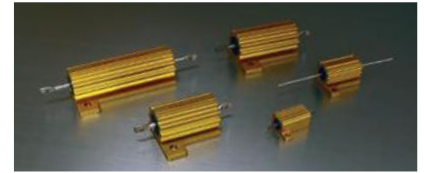

Derating Curve (降功率曲线)

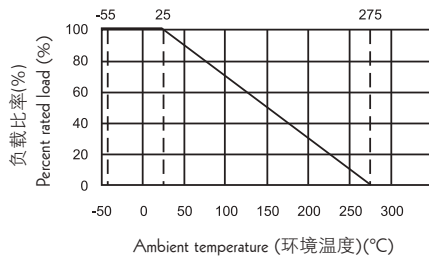

Dimension (尺寸) (mm)

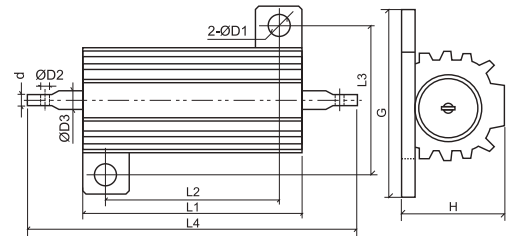

| Part No. 料号 | Type 类型 | L1±0.5 | L2±0.5 | L3±0.5 | L4±1.0 | H±0.5 | G±0.5 | ØD1±0.5 | ØD2±0.2 | ØD3±0.05 | d±0.2 | Tolerance 公差 | Max. Working Voltage 最大工作电压 | Max. Overload Voltage 最大过负荷电压 | Resistance Range 阻值范围 |
|----------------|------------|--------|--------|--------|--------|-------|-------|---------|---------|----------|-------|-----------------|--------------------------------|----------------------------------|--------------------------|
| PDM05W | PDM 5W | 15.5 | 11.0 | 12.0 | 32.5 | 8.0 | 16 | 2 | 1.3 | 1.0 | 0.3 | | 200 | 400 | 0.01Ω~1.8KΩ |
| PDM0AW | PDM 10W | 20.5 | 15.2 | 17.2 | 40.5 | 12.2 | 22.3 | 2.5 | 2.0 | 2.0 | 0.8 | | 300 | 600 | 0.05Ω~5KΩ |
| PDM025 | PDM 25W | 27.5 | 18.2 | 20.2 | 45.5 | 16.3 | 30.3 | 3.0 | 2.0 | 2.0 | 0.8 | ±5% | 550 | 1100 | 0.05Ω~12KΩ |
| PDM035 | PDM 35W | 34.5 | 24.2 | 20.2 | 56.5 | 16.3 | 30.3 | 3.0 | 2.0 | 2.0 | 0.8 | | 950 | 1900 | 0.05Ω~15KΩ |
| PDM050 | PDM 50W | 50.5 | 40.2 | 20.2 | 78.5 | 16.3 | 30.3 | 3.0 | 2.0 | 2.0 | 0.8 | | 1250 | 2500 | 0.05Ω~35KΩ |

Performance Specifications (性能)

| | | |
|---------------------------------|--------|--|
| Temperature coefficient | 温度系数 | <20Ω: ±400PPM/°C; ≥20Ω: ±350PPM/°C |
| Short-time overload | 短时间过负荷 | ΔR/R ≤ ±(5%+0.05Ω), with no evidence of mechanical damage (无可见机械损伤) |
| Dielectric withstanding voltage | 绝缘耐压 | No evidence of flashover, mechanical damage, arcing or insulation breakdown 无击穿、飞弧及可见机械损伤 |
| Terminal strength | 端子强度 | No evidence of mechanical damage (无可见机械损伤) |
| Soldering heat | 耐焊接热 | ΔR/R ≤ ±(1%+0.05Ω), with no evidence of mechanical damage (无可见机械损伤) |
| Solderability | 可焊性 | Min. 95% coverage (最少 95% 覆盖率) |
| Temperature cycling | 温度循环 | ΔR/R ≤ ±(2%+0.05Ω), with no evidence of mechanical damage (无可见机械损伤) |
| Humidity (Steady State) | 恒定湿度 | ΔR/R ≤ ±(5%+0.05Ω), with no evidence of mechanical damage (无可见机械损伤) |
| Load life | 负载寿命 | ΔR/R ≤ ±(5%+0.05Ω) |

Ordering Procedure (Example: PDM 25W 5% 10Ω B/B)

订购方式(例如: PDM 25W 5% 10Ω B/B)

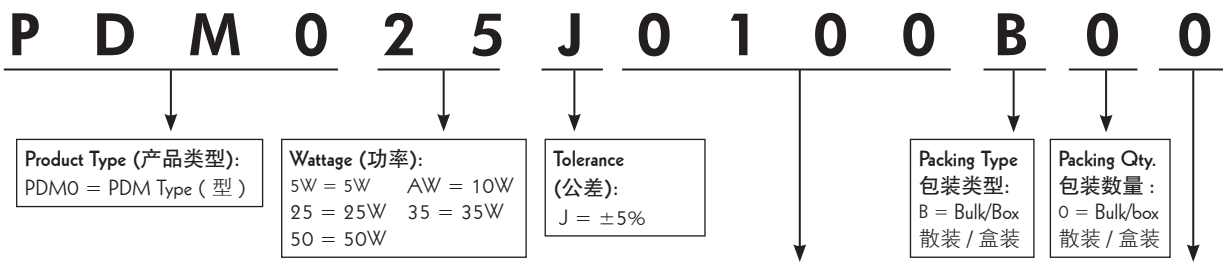

Resistance Value (阻值):
5% (E-24 series): the 1st digit is "0", the 2nd & 3rd digits are for the significant figures of the resistance and the 4th indicate the numbers of zeros following
5% 产品 (E-24 系列阻值):
 第 1 位数是 0, 第 2、3 位数表示阻值的有效数, 第 4 位表示有几个 0;

Additional Information (注):
 0 = NIL (标准品)

Derating Curve (降功率曲线)

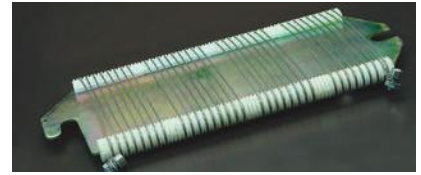

Dimension (尺寸) (mm)



| Part No. 料号 | Type 类型 | L1 ± 1.5 | L2 ± 1.0 | L3 ± 2.0 | W1 ± 1.0 | W2 ± 0.5 | W3 ± 0.3 | W4 ± 0.5 | W5 ± 0.3 | D ± 0.2 | A ± 1.0 |
|----------------|------------|----------|----------|----------|----------|----------|----------|----------|----------|---------|---------|
| BTR0.....350 | BTR 350W | 305 | 255 | 21 | 108 | 61 | 40 | 47 | 35 | 14 | 12 |

Performance Specifications (性能)

| | | |
|-------------------------|-----------|---|
| Power rating at 70°C | 功率 (70°C) | 350W |
| Resistance range | 阻值范围 | 1.0Ω ~ 10.0Ω |
| Tolerance | 公差 | ± 20% |
| Operating temperature | 工作温度范围 | -55°C ~ +350°C |
| Temperature coefficient | 温度系数 | ± 350 PPM/°C |
| Short-time overload | 短时间过负荷 | $\Delta R/R \leq \pm(2\% + 0.05\Omega)$, with no evidence of mechanical damage (无可见机械损伤) |
| Temperature cycling | 温度循环 | $\Delta R/R \leq \pm(5\% + 0.05\Omega)$, with no evidence of mechanical damage (无可见机械损伤) |
| Humidity (Steady State) | 恒定湿热 | $\Delta R/R \leq \pm(5\% + 0.05\Omega)$, with no evidence of mechanical damage (无可见机械损伤) |
| Load life in humidity | 湿度寿命 | $\Delta R/R \leq \pm(5\% + 0.05\Omega)$, with no evidence of mechanical damage (无可见机械损伤) |
| Load life | 负载寿命 | $\Delta R/R \leq \pm(5\% + 0.05\Omega)$, with no evidence of mechanical damage (无可见机械损伤) |

Feature (特性)

- All materials are inorganic and inherently non-burning
所有的材料均为无机或非燃性的固体材料
- The vitreous coating and marking are resistant to all accepted industrial cleaning fluids
涂层抗工业清洗液
- Low temperature coefficient 低温度系数
- Could endure high voltage's impulse in a short time 短时间可承受高电压脉冲
- Could use in single or in-piles 可单个或成堆使用
- Application: Mechanical device, Industry equipment. 应用: 机械设备, 工业机器



Dimension (尺寸) (mm)

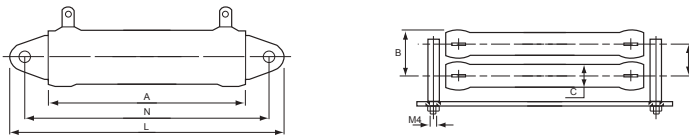

| Type 类型 | A ± 2 | B ± 1 | C ± 0.5 | D ± 1 | L ± 1.5 | N ± 2 |
|---------|-------|-------|---------|-------|---------|-------|
| KNHB21W | 32 | 19 | 12 | 14 | 68 | 51 |
| KNHB31W | 51 | 19 | 12 | 14 | 87 | 70 |
| KNHB53W | 90 | 19 | 12 | 14 | 126 | 109 |
| KNHB68W | 120 | 19 | 12 | 14 | 156 | 140 |
| KNHB91W | 153 | 19 | 12 | 14 | 189 | 173 |

Performance Specifications (性能)

| | | |
|-------------------------|--------|---|
| Resistance range | 阻值范围 | 1Ω~1KΩ |
| Tolerance | 公差 | J(±5%) K(±10%) |
| Short-time overload | 短时间过负荷 | R/R ≤ ±(2%+0.05Ω), with no evidence of mechanical damage (无可见机械损伤) |
| Max. working voltage | 最大工作电压 | 21W:350V 31W:700V 53W:1000V 68W & 91W:1500V |
| Temperature coefficient | 温度系数 | ±200ppm / °C |
| Insulation resistance | 绝缘阻值 | 100MΩ |
| Terminal strength | 端子强度 | No evidence of mechanical damage (无可见机械损伤) |
| Humidity (Steady State) | 恒定湿热 | ΔR/R ≤ ±(2%+0.05Ω), with no evidence of mechanical damage (无可见机械损伤) |
| Load life | 负载寿命 | ΔR/R ≤ ±(5%+0.05Ω), with no evidence of mechanical damage (无可见机械损伤) |

Feature (特性)

- All materials are inorganic and inherently non-burning
所有的材料均为无机或非燃性的固体材料
- Industrial grade Wire-wound resistors 工业线绕电阻
- Super heat dissipation & High stability 散热性高，稳定性好
- Special design of Multi-lead wire easy to assembled on PCB
特殊设计的多导线易于在PCB上安装
- Application: charge resistor or step-down resistor in Electric device
应用：电气设备的充电电阻或降压电阻



Dimension (尺寸) (mm)



Derating Curve (降功率曲线)

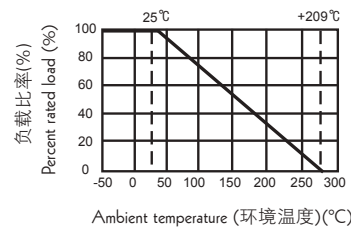

| Type 类型 | L±1 | A±1 | F±1 | P±1 | ØD±1 | Ød±0.05 | Remark 备注 |
|---------|-----|-----|-----|-----|------|---------|--|
| KNHW10W | 45 | 10 | 15 | 12 | 11.5 | 1.0 | the leads could be specially designed according to customer's requirement 引出线可根据客户的要求特别定做 |
| KNHW18W | 40 | 12 | 18 | 15 | 14.5 | 1.0 | |
| KNHW25W | 50 | 12 | 18 | 15 | 14.5 | 1.0 | |
| KNHW40W | 65 | 12 | 20 | 17 | 16.5 | 1.6 | |

Performance Specifications (性能)

| | | |
|-------------------------|--------|---|
| Temperature coefficient | 温度系数 | ±100ppm/°C |
| Short-time overload | 短时间过负荷 | ΔR/R ≤ ±(2%+0.05Ω), with no evidence of mechanical damage (无可见机械损伤) |
| Terminal strength | 端子强度 | No evidence of mechanical damage (无可见机械损伤) |
| Soldering heat | 耐焊接热 | ΔR/R ≤ ±(1%+0.05Ω), with no evidence of mechanical damage (无可见机械损伤) |
| Solderability | 可焊性 | Min. 95% Coverage (最少 95% 覆盖率) |
| Load life in humidity | 湿度寿命 | ΔR/R ≤ ±5%, with no evidence of mechanical damage (无可见机械损伤) |
| Load life | 负载寿命 | ΔR/R ≤ ±5%, with no evidence of mechanical damage (无可见机械损伤) |

Feature (特性)

- Anti-vibration, high stability
优异的抗震性和稳定性
- Easy to assembled on PCB
易于在PCB上安装
- Application: Electric device
应用于电气设备

Derating Curve (降功率曲线)

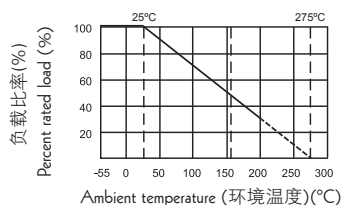

Dimension (尺寸) (mm)

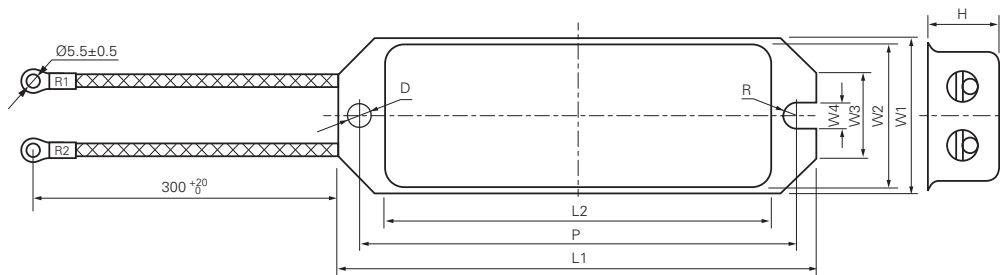

| Part No. 料号 | Type 类型 | Dimension(尺寸) (mm) | | | | | | | | | | Resistance Range 阻值范围 |
|----------------|------------|--------------------|-------|-----|-------|------|------|--------|--------|-------|------|--------------------------|
| | | L1±1 | L2±1 | L3 | P±1 | W1±1 | W2±1 | W3±0.5 | W4±0.2 | D±0.2 | H±1 | |
| HAWR60 | HAWR 60W | 100 | 75.5 | 300 | 90 | 30 | 28 | 16.5 | 4.5 | 4.5 | 16.5 | 1Ω~2KΩ |
| HAWR80 | HAWR 80W | 130.5 | 104.5 | 300 | 117.5 | 43 | 38.5 | 22 | 6.0 | 6.0 | 21 | 1Ω~3KΩ |
| HAWR100 | HAWR 100W | 130 | 110 | 300 | 118 | 42 | 39 | 22.5 | 6 | 6 | 20 | 1Ω~3KΩ |

Performance Specifications (性能)

| | | |
|---------------------------------|--------|---|
| Operating temperature | 工作温度范围 | -55°C~+155°C |
| Temperature coefficient | 温度系数 | ±350PPM |
| Short-time Overload | 短时间过负荷 | $\Delta R/R \leq \pm(5\%+0.05\Omega)$, with no evidence of mechanical damage (无可见机械损伤) |
| Dielectric withstanding voltage | 绝缘耐压 | No evidence of flashover, mechanical damage.(2000V) (2000V, 无击穿、飞弧及可见机械损伤) |
| Resistance to soldering heat | 耐焊接热 | $\Delta R/R \pm(1\%+0.05\Omega)$ |
| Temperature cycling | 温度循环 | $\Delta R/R \leq \pm(5\%+0.05\Omega)$, with no evidence of mechanical damage (无可见机械损伤) |
| Humidity (Steady State) | 恒定湿热 | $\Delta R/R \leq \pm(5\%+0.05\Omega)$, with no evidence of mechanical damage (无可见机械损伤) |
| Load life | 负载寿命 | $\Delta R/R \leq \pm(5\%+0.05\Omega)$, with no evidence of mechanical damage (无可见机械损伤) |

The length "L3" can be designed according to customer's requirement (长"L3"可根据客户要求特殊制作)

Ordering Procedure (Example:HAWR 100W 5% 100E T/B-1000)

订购方式(例如: HAWR 100W 5% 100E T/B-1000)

H A W R 0 0 J 0 1 0 1 1 0 0

Product Type (产品类型):
HAWR= High Power Wire Wound Boat form Fixed Resistor (高功率绕线船形固定电阻器)

Wattage (功率):
60=60W 80=80W
00=for power rating over 100W, please indicate the power rating at the last 3 digits of the part No.(大于100W 用料号后面的三位数字表面功率)

Tolerance (公差):
J = ±5%

Resistance Value (阻值):
E-24 series: the 1st digit will be "0", the 2nd & 3rd digits are for the significant figures of the resistance and the 4th digit denotes number of zeros following:
E-24 系列阻值: 第1位数是0, 第2、3位数表示阻值的有效数, 第4位表示有几个0;

Additional Information (注):
100 = 100W

Feature (特性)

- Anti-vibration, high stability
优异的抗震性和稳定性
- Easy to assembled on PCB
易于在 PCB 上安装
- Application: Electric device
应用于电气设备

Derating Curve (降功率曲线)



Dimension (尺寸)(mm)

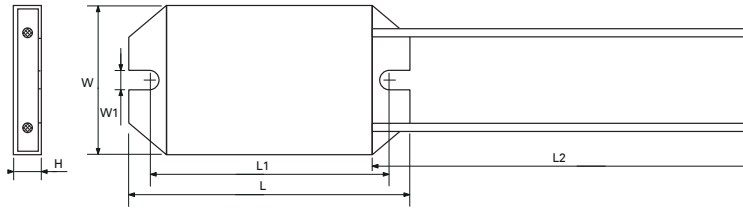

| Type 类型 | L±1.0 | L1±0.5 | L2 ⁺²⁰ / ₋₀ | W±0.5 | W1±0.2 | H±0.5 | Resistance Range 阻值范围 |
|------------|-------|--------|-----------------------------------|-------|--------|-------|--------------------------|
| HPWR40W | 85 | 72 | 300 | 45 | 5.5 | 8.2 | 1Ω~100Ω |

Specification (性能)

| | | |
|---------------------------------|--------|---|
| Operating temperature | 工作温度范围 | -55°C~+155°C |
| Temperature coefficient | 温度系数 | ±300PPM |
| Short-time Overload | 短时间过负荷 | ΔR/R ≤ ±(5%+0.05Ω), 10 times power rating for 5s, with no evidence of mechanical damage (10 倍額功率 5 秒, 無可見機械損傷) |
| Dielectric withstanding voltage | 绝缘耐压 | No evidence of flashover, mechanical damage. (3000V) (3000V, 無擊穿、飛弧及可見機械損傷) |
| Resistance to soldering heat | 耐焊接热 | ΔR/R ≤ ±(1%+0.05 Ω) |
| Temperature cycling | 温度循环 | ΔR/R ≤ ±(5%+0.05Ω), with no evidence of mechanical damage (無可見機械損傷) |
| Humidity (Steady State) | 恒定湿热 | ΔR/R ≤ ±(5%+0.05Ω), with no evidence of mechanical damage (無可見機械損傷) |
| Load life | 负载寿命 | ΔR/R ≤ ±(5%+0.05Ω), room temperature, 1.5H "ON"/0.5H "OFF", with no evidence of mechanical damage (室温下 1.5 小時通, 0.5 小時斷, 無可見機械損傷) |

Ordering Procedure (Example: HPWR 40W 5% 50Ω T/B-1000)

订购方式 (例如: HPWR 40W 5% 50Ω T/B-1000)



Feature (特性)

- Anti-vibration, high stability
优异的抗震性和稳定性
- Easy to assembled on PCB
易于在 PCB 上安装
- Application: Electric device
应用于电气设备

Derating Curve (降功率曲线)

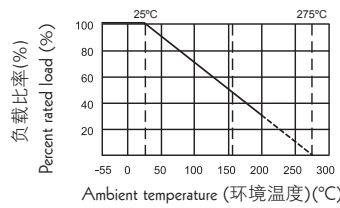

Dimension (尺寸)(mm)

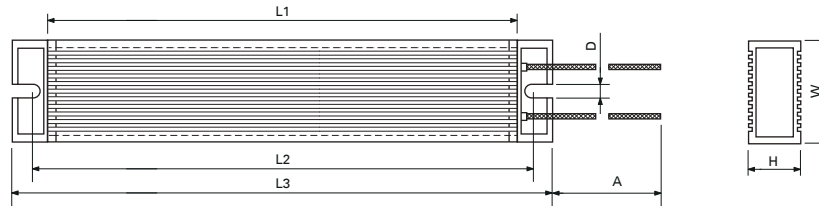

| Type 类型 | Dimension (尺寸) (mm) | | | | | | | Resistance Range 阻值范围 |
|-----------|---------------------|--------|--------|--------|-------|-------|-------|-----------------------|
| | A±10 | L1±0.5 | L2±0.5 | L3±0.3 | W±0.2 | H±0.1 | D±0.1 | |
| HPAR 40W | 300 | 50 | 80 | 62 | 40 | 20 | 5.2 | 1Ω~5KΩ |
| HPAR 60W | 300 | 85 | 115 | 97 | 40 | 20 | 5.2 | 1Ω~10KΩ |
| HPAR 80W | 300 | 110 | 140 | 122 | 40 | 20 | 5.2 | 1Ω~10KΩ |
| HPAR 100W | 300 | 130 | 160 | 142 | 40 | 20 | 5.2 | 1Ω~12KΩ |
| HPAR 120W | 300 | 155 | 190 | 172 | 40 | 20 | 5.2 | 1Ω~18KΩ |
| HPAR 150W | 300 | 185 | 215 | 197 | 40 | 20 | 5.2 | 1Ω~20KΩ |

Specification (性能)

| | |
|--------------------------------------|---|
| Operating temperature 工作温度范围 | -55°C~+155°C |
| Temperature coefficient 温度系数 | ±350PPM |
| Short-time Overload 短时间过负荷 | $\Delta R/R \leq \pm(5\% + 0.05\Omega)$, 10 times power rating for 5s, with no evidence of mechanical damage (10 倍额定功率 5 秒, 無可見機械損傷) |
| Dielectric withstanding voltage 绝缘耐压 | No evidence of flashover, mechanical damage. (3000V) (3000V, 無擊穿、飛弧及可見機械損傷) |
| Resistance to soldering heat 耐焊接热 | $\Delta R/R \pm(1\% + 0.05\Omega)$ |
| Temperature cycling 温度循环 | $\Delta R/R \leq \pm(5\% + 0.05\Omega)$, with no evidence of mechanical damage (無可見機械損傷) |
| Humidity (Steady State) 恒定湿热 | $\Delta R/R \leq \pm(5\% + 0.05\Omega)$, with no evidence of mechanical damage (無可見機械損傷) |
| Load life 负载寿命 | $\Delta R/R \leq \pm(5\% + 0.05\Omega)$, room temperature, 1.5H "ON" 0.5H "OFF", with no evidence of mechanical damage (室温下 1.5 小時通, 0.5 小時斷, 無可見機械損傷) |

Ordering Procedure (Example: HPAR 100W 5% 100Ω T/B-1000)

订购方式 (例如: HPAR 100W 5% 100Ω T/B-1000)

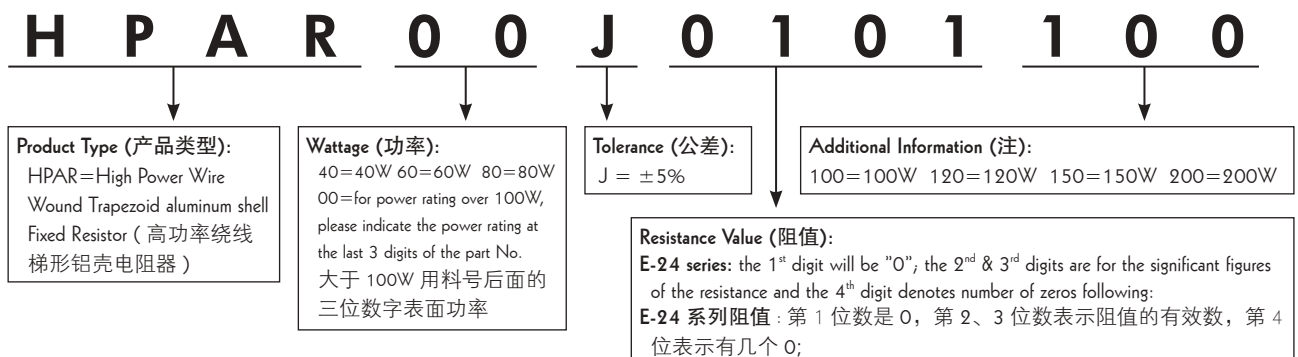

Feature (特性)

- Anti-vibration, high stability
优异的抗震性和稳定性
- Easy to assembled on PCB
易于在 PCB 上安装
- Application: Electric device
应用于电气设备

Derating Curve (降功率曲线)

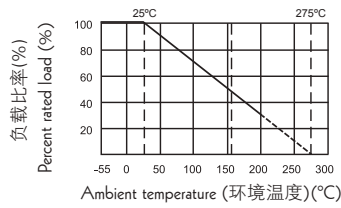

Dimension (尺寸)(mm)

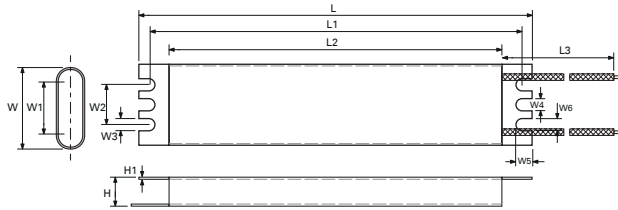

120W

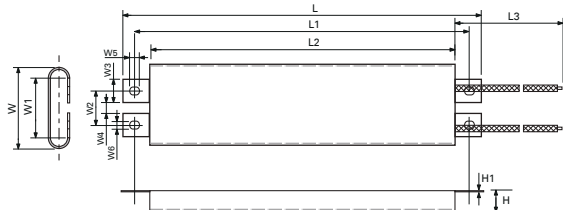

110W, 220W

| Type 类型 | L ₅ ⁺⁰ | L1±0.5 | L2 ^{+0.5} ₋₀ | L3±5 | W±0.5 | W1±0.1 | W2±0.2 | W3±0.2 | W4±0.5 | W5±0.05 | W6±0.05 | H1±0.05 | H±0.5 | Resistance Range 阻值范围 |
|-----------|------------------------------|--------|----------------------------------|------|-------|--------|--------|--------|--------|---------|---------|---------|-------|-----------------------|
| HPWR 110W | 105 | 91.5 | 78 | 300 | 44.6 | 33 | 19 | 13 | 6 | 5.8 | 4.3 | 0.8 | 11.5 | 5Ω~100Ω |
| HPWR 120W | 195 | 184 | 165 | 250 | 40 | 26 | 19 | 5.5 | 5.5 | 8.25 | 5.5 | 0.8 | 14 | |
| HPWR 220W | 200 | 187 | 170 | 250 | 44.6 | 33 | 19 | 13 | 6 | 5.8 | 4.3 | 0.8 | 11.5 | |

Specification (性能)

| | |
|--------------------------------------|---|
| Operating temperature 工作温度范围 | -55°C~+155°C |
| Temperature coefficient 温度系数 | ±300PPM |
| Short-time Overload 短时间过负荷 | ΔR/R ≤ ±(5%+0.05Ω), 10 times power rating for 5s, with no evidence of mechanical damage (10 倍額功率 5 秒, 無可見機械損傷) |
| Dielectric withstanding voltage 绝缘耐压 | No evidence of flashover, mechanical damage.(3000V) (3000V, 無擊穿、飛弧及可見機械損傷) |
| Resistance to soldering heat 耐焊接热 | ΔR/R ≤ ±(1%+0.05 Ω) |
| Temperature cycling 温度循环 | ΔR/R ≤ ±(5%+0.05Ω), with no evidence of mechanical damage (無可見機械損傷) |
| Humidity (Steady State) 恒定湿热 | ΔR/R ≤ ±(5%+0.05Ω), with no evidence of mechanical damage (無可見機械損傷) |
| Load life 负载寿命 | ΔR/R ≤ ±(5%+0.05Ω), room temperature, 1.5H "ON"0.5H"OFF", with no evidence of mechanical damage (室温下 1.5 小時通, 0.5 小時斷, 無可見機械損傷) |

Ordering Procedure (Example:HPWR 100W 5% 100Ω T/B-1000)

订购方式 (例如: HPWR 100W 5% 100Ω T/B-1000)

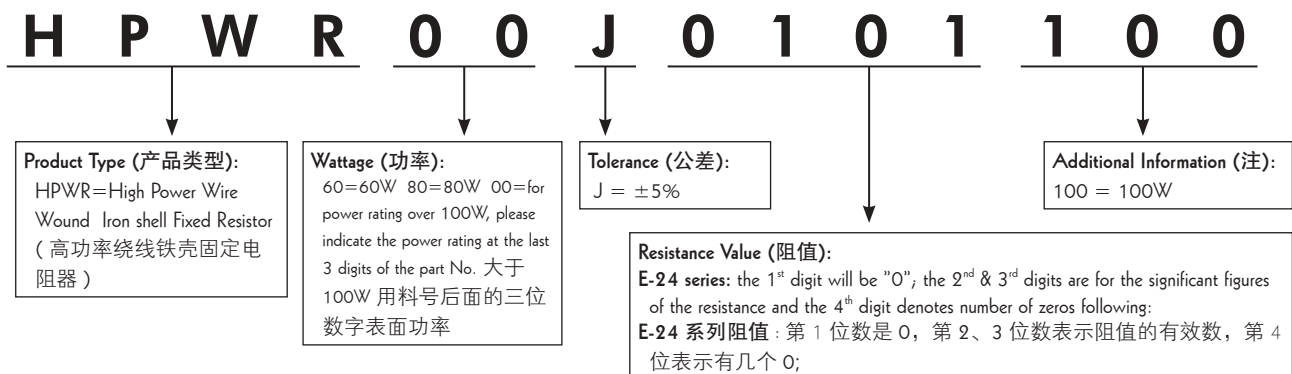

Feature (特性)

- Flat resistor inside a zinc plated metallic case, composed by two coupled shells
镀锌金属外壳，有两个耦合的组成平面电阻
- High insulative & heat-resistant performance 优异的绝缘性和耐热性
- Can withstand high overload current in short time 可短时间承受高过载电流
- Super heat dissipation, easy to assembled on PCB. 散热好，易于在PCB上安装
- Application: Charge resistor or step-down resistor in Electric device & Elevator, Inverter
应用：电气设备和电梯专用变频器的充电电阻或降压电阻



Dimension (尺寸) (mm)

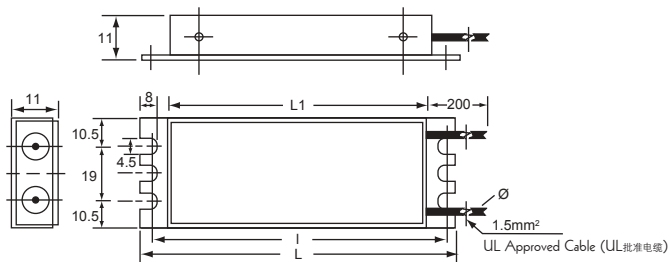

| Type 类型 | $L \pm 1$ | $L \pm 1$ | $L1 \pm 1$ | $\varnothing \pm 0.05$ | Remark 备注 |
|------------|-----------|-----------|------------|------------------------|--|
| HAWF100W | 89 | 100 | 70 | 2.5 | the cable can be specially designed according to customer's requirement 引出线可根据客户的要求特别定做 |
| HAWF150W | 134 | 145 | 115 | 2.5 | |
| HAWF200W | 184 | 195 | 165 | 2.5 | |

Specification (性能)

| Type 型号 | HAWF100W | HAWF150W | HAWF200W |
|--|------------|----------|------------|
| Nominal Power Rating 标称功率 | 50W | 75W | 100W |
| Power Rating for Mounted on the deck 安装在散热板上的功率 | 100W | 150W | 200W |
| Resistance Range 阻值范围 | 0.5Ω~2.5KΩ | 0.5Ω~5KΩ | 0.5Ω~7.5KΩ |
| Tolerance 公差 | ±5% | ±5% | ±5% |
| Dielectric Withstanding Voltage (50Hz, 1min) 绝缘耐压 (50赫兹, 1分钟) | 3000V | 3000V | 3000V |
| Insulation resistance 绝缘电阻 | 1000MΩ | 1000MΩ | 1000MΩ |
| Time Constant 时间常数 | ≈8' | ≈8' | ≈8' |
| Energy absorbed in 5 seconds 5秒内能量的吸收 | 5.0KJ | 7.5KJ | 10KJ |
| Surface Temperature 表面温度 | 300°C | 300°C | 300°C |

Feature (特性)

- Small size & sturdy mechanically safe 尺寸小、机械性能安全
- High safety standard 安全系数高
- Application: Motor cycle 应用：摩托车

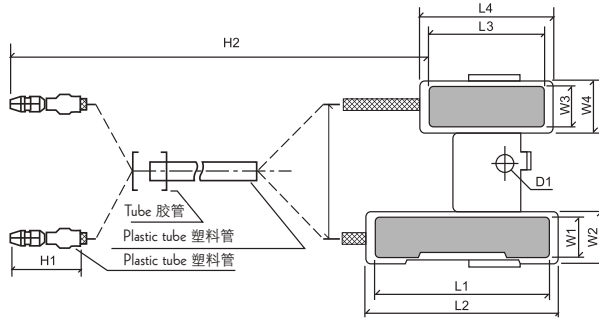

Derating Curve (降功率曲线)

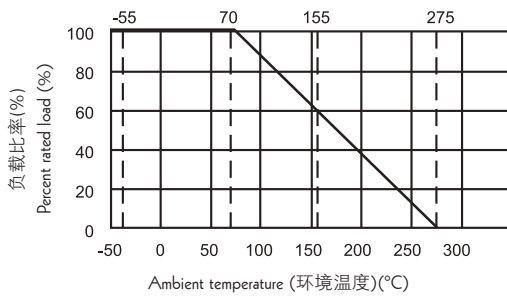

Dimension (尺寸) (mm)

| Type 类型 | L ₁ +0.5 | L ₂ ±1 | L ₃ ±0.5 | L ₄ ±1 | W ₁ ±0.5 | W ₂ ±1 | W ₃ +0.5 | W ₄ +1 | H ₁ Max. | H ₂ ⁺¹⁰ / ₋₀ | D ₁ ^{+0.5} / ₋₀ | Resistance Range 阻值范围 |
|------------|---------------------|-------------------|---------------------|-------------------|---------------------|-------------------|---------------------|-------------------|---------------------|---|--|--------------------------|
| BCR 20W+5W | 64 | 66 | 42 | 44 | 13 | 15 | 13 | 15 | 30 | 250 | 6.5 | 0.5Ω - 100Ω |

Performance Specifications (性能)

| | | |
|---------------------------------|--------|--|
| Temperature coefficient | 温度系数 | ±400PPM/°C |
| Short-time overload | 短时间过负荷 | ΔR/R ≤ ±(5.0%+0.05Ω), with no evidence of mechanical damage (无可见机械损伤) |
| Dielectric withstanding voltage | 绝缘耐压 | No flashover, mechanical damage, arcing or insulation breakdown 无击穿、飞弧及可见机械损伤 |
| Temperature cycling | 温度循环 | ΔR/R ≤ ±(5.0%+0.05Ω), with no evidence of mechanical damage (无可见机械损伤) |
| Humidity (Steady State) | 恒定湿热 | ΔR/R ≤ ±(5.0%+0.05Ω), with no evidence of mechanical damage (无可见机械损伤) |
| Load life in humidity | 湿度寿命 | ΔR/R ≤ ±(5.0%+0.05Ω), with no evidence of mechanical damage (无可见机械损伤) |
| Load life | 负载寿命 | ΔR/R ≤ ±(5.0%+0.05Ω), with no evidence of mechanical damage (无可见机械损伤) |

Feature (特性)

- High stable performance & power rating 稳定性好, 功率高
- Safety flameproof construction, excellent moisture resistance 安全阻燃, 防潮
- Application: applied to DC & AC low frequency circuit as step-down voltage, shunt or overload resistor in electrical equipment & instrument
应用: 适用于直流, 交流降压电压, 分流或超负荷电气设备及仪器的低频电路



Dimension (尺寸) (mm)

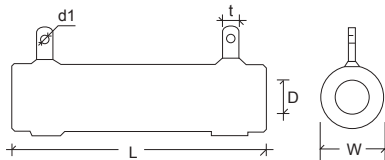

Derating Curve (降功率曲线)

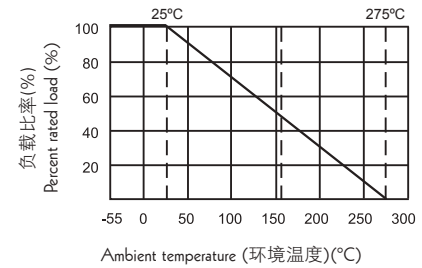

| Type 规格 | L | P | W | D | d1 | t | Resistance Range 阻值范围 (±5% ±10%) |
|------------|---------|--------|--------|---------|---------|---------|--|
| URX8W | 35±1.5 | 23.5±1 | 14±2 | 5.5±0.4 | 2.0±0.1 | 4.5±0.1 | 1Ω-620Ω |
| URX10W | 41±1.5 | 29.5±1 | 15±1 | 5.5±0.4 | 2.0±0.1 | 4.5±0.1 | 1Ω-620Ω |
| URX 15W | 45±1.5 | 33.5±1 | 17±2 | 8±0.5 | 2.0±0.1 | 4.5±0.1 | 1Ω-910Ω |
| URX 20W | 51±2 | 39.5±1 | 17±2 | 8±0.6 | 2.0±0.1 | 4.5±0.1 | 1Ω-1.1KΩ |
| URX 25W | 51±2 | 39.5±1 | 21±2.5 | 12±0.8 | 2.0±0.1 | 4.5±0.1 | 1Ω-1.3KΩ |
| URX 30W | 71±2.2 | 59.5±1 | 21±2.5 | 12±0.8 | 2.0±0.1 | 4.5±0.1 | 1Ω-2.2KΩ |
| URX 40W | 87±2.2 | 75.5±1 | 21±2.5 | 12±0.8 | 2.0±0.1 | 4.5±0.1 | 1Ω-3KΩ |
| URX 50W | 91±2.4 | 81±1 | 29±3 | 20±1 | 2.5±0.1 | 6.0±0.1 | 1Ω-4.3KΩ |
| URX 75W | 140±3.2 | 129±1 | 29±3 | 20±1 | 2.5±0.1 | 6.0±0.1 | 1Ω-6.2KΩ |
| URX 100W | 170±3.5 | 159±1 | 29±3 | 20±1 | 2.5±0.1 | 6.0±0.1 | 1Ω-8.2KΩ |
| URX 150W | 215±3.5 | 205±1 | 29±3 | 20±1 | 2.5±0.1 | 6.0±0.1 | 1Ω-11KΩ |

Performance Specifications (性能)

| | | | |
|--------------------------|--------|--|---|
| Short-time overload | 短时间过负荷 | $\Delta R \leq \pm(1\%R + 0.05\Omega)$ | 10 times rated power rating, 5 seconds 施加10倍额定功率负荷5S |
| Shock | 冲击 | $\Delta R \leq (1\%R + 0.05\Omega)$ | acceleration 390m/s ² , 11ms, 18 times 加速度 390m/s ² , 11ms, 18 次 |
| Temperature quick change | 温度快速变化 | $\Delta R \leq (1\%R + 0.05\Omega)$ | -55°C~+200°C, 5times cycling (5次循环) |
| Crash | 碰撞 | $\Delta R \leq (1\%R + 0.05\Omega)$ | acceleration 390m/s ² , 4000 times 加速度390m/s ² , 4000 次 |
| Terminal strength | 端子强度 | $\Delta R \leq (1\%R + 0.05\Omega)$ | ≤4.3W 10N; ≥6W 20N |
| Vibration | 振动 | $\Delta R \leq (1\%R + 0.05\Omega)$ | Frequency 10-500HZ, acceleration 98m/s ² 2.6h 频率10-500HZ, 加速度 98m/s ² , 2.6h |
| Humidity (Steady State) | 恒定湿热 | $\Delta R \leq (5\%R + 0.05\Omega)$ | Temperature 40±2°C, humidity 95—92% place 240Hr 温度 40±2°C, 湿度 95—92% 放置240小时 |
| Load life | 负载寿命 | $\Delta R \leq (5\%R + 0.05\Omega)$ | Rated power rating, 1000h, room temperature 室温施加额定负荷功率1000h |
| Solderability | 可焊性 | Min. 95% coverage (最少95%覆盖率) | 245°C±3°C |
| Temperature rise | 温升 | <245°C | Rated power rating (施加额定负荷功率) |

Derating Curve (降功率曲线)



Circuit Structure (电路图)



Dimension (尺寸) (mm)



Performance Specifications (性能)

| | | | |
|---|--------------|-------|-----|
| Type 类型 | TFO 20W | a ± 5 | 125 |
| Power rating at 70°C 功率 | 20W | b ± 1 | 16 |
| Resistance 阻值范围 | 1.1 + 2.4Ω | c ± 1 | 5 |
| Temperature coefficient 温度系数 | ± 350 PPM/°C | d ± 1 | 50 |
| Fusing temperature TF 额定工作温度 TF | 216°C | e ± 1 | 5 |
| Rated current I _r 额定电流 I _r | 10A | f ± 5 | 130 |
| Rated voltage V _r 额定电压 V _r | 250V | h ± 1 | 4 |
| | | i ± 1 | 24 |
| | | j ± 1 | 2.5 |
| | | l ± 1 | 15 |
| | | m ± 1 | 5 |

Feature (特性)

- Multi leads arrange encapsulation & space saving 多引线排列封装、节约空间
- Superior function of circuit overtemperature protection 良好的电路超温保护功能
- Excellent flame & moisture resistance 良好阻燃性、抗湿性
- Other ohmic value can be provided on a case to case basis 其它阻值也可以提供



Derating Curve (降功率曲线)



| Type 类型 | Power Rating 功率 (70°C) | Resistance Range 阻值范围 | Tolerance 公差 | Temperature Coefficient 温度系数 (PPM/°C) | Cut-off Temperature 额定动作温度 (°C) | Rated Current I _r 额定电流 (A) | Rated Voltage U _r 额定电压 (V) |
|------------|------------------------------|--------------------------|-----------------|---|---------------------------------------|---|---|
| TFRC 2W | 2W | 360+360Ω | ± 5% | ± 350 | 91 | 10 | 250 |

Feature (特性)

- Multi-terminal types & variable types available
多端子和多可调阻方式都可提供
- Small in size but capable of carrying high power load
小体型负载大功率
- Resistance value unchanged after long use, good resistivity to short time overload
长年使用不变阻值，短时间过负荷表现良好
- High resistivity to heat, small resistance temperature coefficient and the change in resistance with temperature being linear
抗热，温度系数低，温度变化小
- Too low or high ohmic value can be supplied on a case to case basis
超低或超高阻值都可特别提供
- Adjustable & Multi-Resistor type is available
可调型与多阻型可提供
- Non-Inductive type is available
可提供无感型



Power Wire-wound Resistors - QH & QL Type

功率型绕线电阻 – QH & QL 型

QH Type (QH 型)

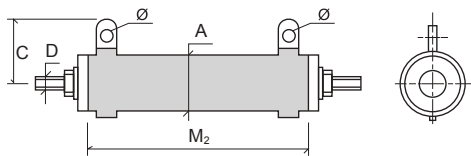

QL Type (QL 型)

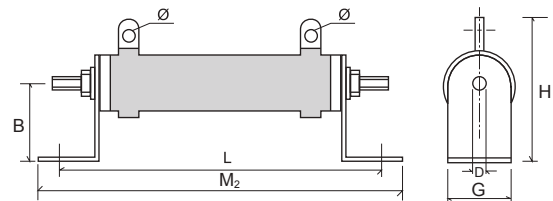

| Part No. 料号 | Wattage 功率 | Dimension (尺寸) (mm) | | | | | | | | | | Resistance Range 阻值范围 |
|-------------------|---------------|---------------------|-----|-----|-----|-----|-----|-------------------|-------------------|-----|-------|--------------------------|
| | | A±1.5 | B±1 | C±1 | D±1 | G±1 | L±2 | M ₁ ±2 | M ₂ ±2 | H±1 | Ø±0.1 | |
| QH / QL0020 | 20W | 19 | 19 | 19 | 4.5 | 18 | 81 | 91 | 50 | 38 | 2.5 | 1Ω~1KΩ |
| QH / QL0025 | 25W | 19 | 19 | 19 | 4.5 | 18 | 91 | 101 | 60 | 38 | 2.5 | 2Ω~2KΩ |
| QH / QL0030 | 30W | 19 | 19 | 19 | 4.5 | 18 | 106 | 116 | 75 | 38 | 3.5 | 2Ω~3KΩ |
| QH / QL0040 | 40W | 19 | 19 | 19 | 4.5 | 18 | 121 | 131 | 90 | 38 | 3.5 | 2Ω~5KΩ |
| QH / QL0050 | 50W | 31 | 27 | 31 | 4.5 | 26 | 106 | 126 | 75 | 58 | 4.5 | 3Ω~10KΩ |
| QH / QL0060 | 60W | 31 | 27 | 31 | 4.5 | 26 | 121 | 141 | 90 | 58 | 4.5 | 3Ω~15KΩ |
| QH / QL0080 | 80W | 31 | 27 | 31 | 4.5 | 26 | 146 | 166 | 115 | 58 | 4.5 | 3Ω~20KΩ |
| QH / QL00.....100 | 100W | 31 | 27 | 31 | 4.5 | 26 | 171 | 191 | 140 | 58 | 4.5 | 3Ω~50KΩ |
| QH / QL00.....120 | 120W | 31 | 27 | 31 | 4.5 | 26 | 196 | 216 | 165 | 58 | 5.5 | 4Ω~50KΩ |
| QH / QL00.....150 | 150W | 31 | 27 | 31 | 4.5 | 26 | 226 | 246 | 195 | 58 | 5.5 | 4Ω~50KΩ |
| QH / QL00.....200 | 200W | 31 | 27 | 31 | 4.5 | 26 | 286 | 306 | 254 | 58 | 5.5 | 5Ω~60KΩ |
| QH / QL00.....300 | 300W | 42 | 38 | 38 | 5.5 | 40 | 290 | 324 | 254 | 79 | 5.5 | 8Ω~80KΩ |
| QH / QL00.....400 | 400W | 42 | 38 | 38 | 5.5 | 40 | 365 | 400 | 330 | 79 | 5.5 | 10Ω~100KΩ |
| QH / QL00.....600 | 600W | 42 | 38 | 38 | 5.5 | 40 | 456 | 490 | 420 | 79 | 5.5 | 10Ω~200KΩ |

Power Ribbon Wire-wound Resistors - QR & QRZG Type

功率型绕线电阻 – QR & QRZG 型

QR Type (QR 型)

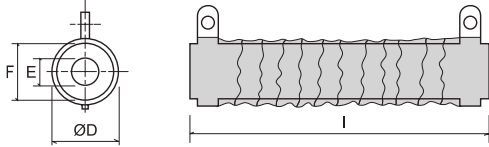

QRZG Type (QRZG 型)

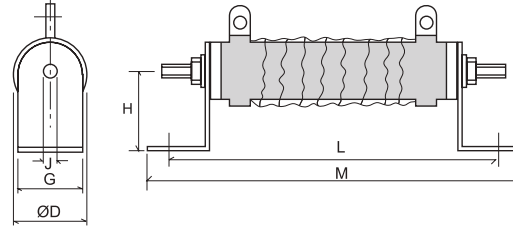

| Part No. 料号 | Wattage 功率 | Dimension (尺寸)(mm) | | | | | | | | | Resistance Range 阻值范围 |
|----------------|---------------|--------------------|-----|-----|-----|-----|-----|-----|-----|-----|--------------------------|
| | | ØD±2 | E±1 | F±1 | G±1 | H±1 | J±1 | L±1 | L±2 | M±2 | |
| QR00.....120 | 120W | 33 | 16 | 28 | 26 | 31 | 4.5 | 115 | 146 | 166 | 0.2Ω~4Ω |
| QRZG.....120 | | | | | | | | | | | |
| QR00.....150 | 150W | 33 | 16 | 28 | 26 | 31 | 4.5 | 140 | 171 | 191 | 0.3Ω~5Ω |
| QRZG.....150 | | | | | | | | | | | |
| QR00.....180 | 180W | 33 | 16 | 28 | 26 | 31 | 4.5 | 165 | 196 | 216 | 0.3Ω~6Ω |
| QRZG.....180 | | | | | | | | | | | |
| QR00.....225 | 225W | 33 | 16 | 28 | 26 | 31 | 4.5 | 195 | 226 | 246 | 0.4Ω~8Ω |
| QRZG.....225 | | | | | | | | | | | |
| QR00.....300 | 300W | 33 | 16 | 28 | 26 | 31 | 4.5 | 254 | 285 | 305 | 0.5Ω~10Ω |
| QRZG.....300 | | | | | | | | | | | |
| QR00.....450 | 450W | 48 | 25 | 40 | 40 | 38 | 5.5 | 254 | 290 | 324 | 0.8Ω~15Ω |
| QRZG.....450 | | | | | | | | | | | |
| QR00.....600 | 600W | 48 | 25 | 40 | 40 | 38 | 5.5 | 330 | 366 | 400 | 1Ω~20Ω |
| QRZG.....600 | | | | | | | | | | | |

Ordering Procedure (Example: QRZG 225W 5% 1.8Ω B/B)

订购方式 (例如: QRZG 225W 5% 1.8Ω B/B)

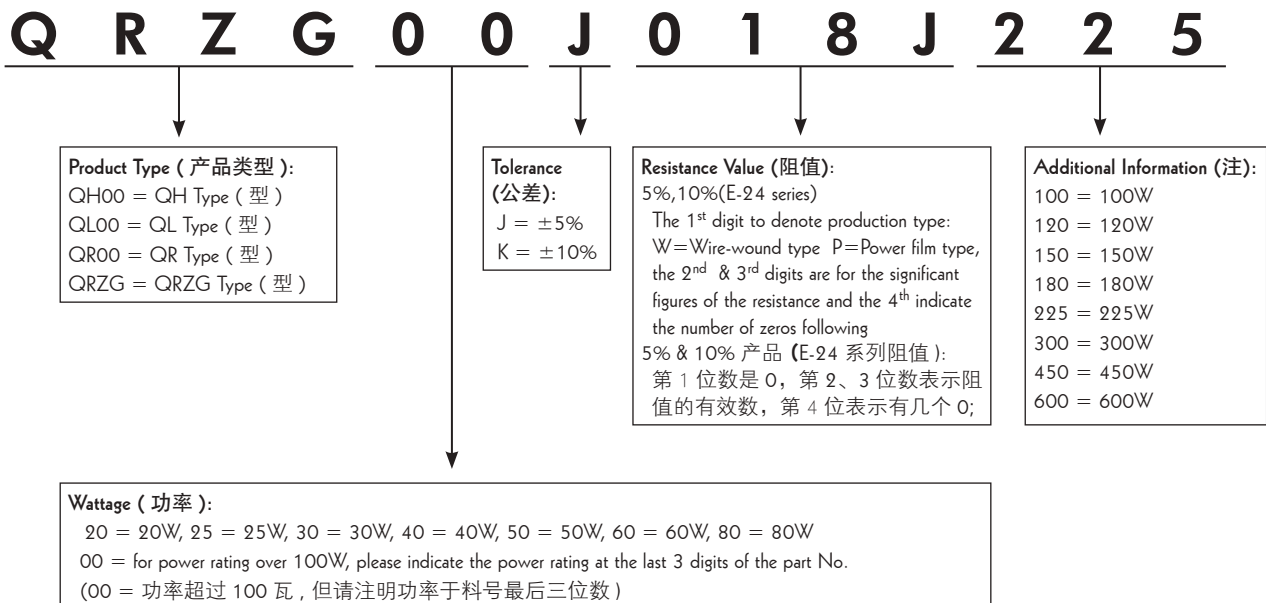

JIS-C-5201和JIS-C-5202检测方法

| | |
|---|---|
| <p>Temperature coefficient 温度系数 (JIS-C-5201 4.8)</p> | <p>Natural resistance change per temperature degree centigrade 实际阻值随温度变化的变化率： $\frac{R_2 - R_1}{R_1(t_2 - t_1)} \times 10^6 \text{ (PPM / } ^\circ\text{C)}$ R₁: Resistance value at room temperature 室温下的阻值 (t₁); R₂: Resistance value at room temperature +100°C 室温加上 100°C 的阻值 (t₂). Test pattern: Room temperature (t₁), Room temperature +100°C (t₂) 测试结构：室温 (t₁), 室温 +100°C (t₂)</p> |
| <p>Short-time overload 短时间过负荷 (JIS-C-5201 4.13)</p> | <p>Permanent resistance change after the application of a potential of 2.5 times RCWV or Max. Overload Voltage whichever less for 5 seconds. 加 2.5 倍额定工作电压或最大过负荷电压 (取其低者), 持续 5 秒钟, 测阻值变化。</p> |
| <p>Insulation resistance 绝缘阻值 (JIS-C-5201 4.6)</p> | <p>1. Chip Resistor: the measuring voltage shall be ,measured with a direct voltage of (100±15)V or a voltage equal to the dielectric withstanding voltage, and apply for 1min. 2. TH Resistor: The measuring voltage shall be either(100±15) V DC for resistors with an insulation voltage <500V or (500±50)V DC,for resistors with an isolation voltage≥500V. 1. 贴片电阻：绝缘耐压 <100V, 测试电压取绝缘耐压的电压；绝缘耐压 ≥100V, 测试电压为 100±15 VDC,1 分钟后量测阻值。 2. 插件电阻：绝缘耐压 <500V, 测试电压取绝缘耐压的电压；绝缘耐压 ≥500V, 测试电压为 500±50 VDC,1 分钟后量测阻值。</p> |
| <p>Dielectric withstanding voltage 绝缘耐压 (JIS-C-5201 4.7)</p> | <p>Resistor shall be clamped in the trough of 90°C metallic V - block and shall be tested at AC potential respectively specified in the given list of each product type for 60-70 seconds. For Cement Fixed Resistors, the testing voltage is 1,000V. 电阻固定在 90°C 的 V 型槽中, 根据不同产品规定交流电压, 持续 60~70 秒, 水泥型电阻电压设定为 1000V.</p> |
| <p>Pulse overload 脉冲过负荷 (JIS-C-5201 4.28)</p> | <p>Resistance change after 10,000 cycles (1 second "ON", 25 seconds "OFF") at 4 times of RCWV or Max. Overload whichever less. 10,000 次循环后变化 (1 秒 "通"、25 秒断) 4 倍工作电压或最大工作电压 (取其最低者)。</p> |
| <p>Terminal strength 端子强度 (JIS-C-5201 4.16)</p> | <p>Direct Load: Resistance at a 2.5kg direct load for 10 seconds in the direction of the longitudinal axis of the terminal leads. Twist Test: Terminal leads shall be bent through 90° at a point of about 6mm from the body of the resistor and shall be rotated through 360° about the original axis of the bent terminal in alternating direction for a total of 3 rotations. 直接负荷：在电阻引线方向直接加 2.5 公斤力 10 秒。扭曲测试：两端导线折弯 90 度在熔点 6mm 处交替旋转 360 度 3 次。</p> |
| <p>Terminal strength 端子强度 (JIS-C-5201 4.16)</p> | <p>(Applicable for Resistor Network 适用网络电阻) Tensile: 1KG, 30 seconds / Bending: 500g, 2 times 张力：1KG, 30 秒 / 弯曲：500g, 2 次。</p> |
| <p>Terminal bending 端子弯曲 (JIS-C-5201 4.33)</p> | <p>(Applicable for CHIP Resistors 适用晶片电阻) Twist of Test Board: Y / X = 3/90mm 60 seconds. 测试板弯曲：Y / X = 3/90mm 60 秒。</p> |
| <p>Soldering heat 耐焊接热 (JIS-C-5201 4.18)</p> | <p>(Applicable for CHIP Resistors 适用晶片电阻) Dip the resistor into a solder bath having a temperature of 260±5°C and hold it for a 10±1 seconds. 将电阻浸入 260±5°C 锡炉 10±1 秒。</p> |
| <p>Soldering heat 耐焊接热 (JIS-C-5201 4.18)</p> | <p>(Applicable for TH Resistors 适用插件电阻) Permanent resistor change when leads immersed to a point 2.0~2.5mm from the body in 260±5°C solder 10±1 seconds. 锡炉温度 260±5°C, 浸入深度：离本体导线根部约 2.0~2.5mm, 处浸入时间 10±1 秒。</p> |
| <p>Solderability 可焊性 (JIS-C-5201 4.17)</p> | <p>The area covered with a new, smooth, clean, shiny and continuous surface free from concentrated pinholes. Temperature of solder: 245±3°C; Dwell time in solder: 2-3 seconds. 表面光滑、清洁、均匀、有光泽, 锡炉温度：245±3°C, 浸入时间：2-3 秒。</p> |
| <p>Resistance to solvent 耐溶剂 (JIS-C-5201 4.29)</p> | <p>Specimens shall be immersed in a bath of alcohol completely for a 3 mintues using ultrasonic test equipment. 电阻浸入异丙醇超声波清洗 3 分钟。</p> |
| <p>Thermal shock 热冲击 (JIS-C-5201 4.21)</p> | <p>(Applicable for Resistor Network 适用于网络电阻) Load V, Room temperature, 30 minutes. Unload, -55°C, 15 minutes. Over 2 hours in room temperature before measuring. 加电压：室温 30 分钟。不加电压：-55°C, 15 分钟。室温下过 2 小时测量变化率。</p> |
| <p>Temperature cycling 温度循环 (JIS-C-5201 4.19)</p> | <p>Resistance change after continuous 5 cycles for duty cycle specified below Step 1: 30 mintues at -55±3°C Step 2: 10~15 minutes at Room temperature Step 3: 30 mintues at 155±2°C Step 4: 10~15 minutes at Room temperature 连续 5 次温度循环 (如下所示) 步骤 步骤 1: 温度：-55±3°C 时间：30 分钟 步骤 2: 温度：室温 时间：10~15 分钟 步骤 3: 温度：155±2°C 时间：30 分钟 步骤 4: 温度：室温 时间：10~15 分钟</p> |
| <p>Humidity (Steady State) 恒定湿热 (JIS-C-5201 4.24)</p> | <p>Temporary resistance change after 240 hours exposure in a humidity test chamber controlled at 40±2°C and 90-95% RH. 在 40±2°C 和 90-95%RH 相对湿度条件下, 存放 240 小时后阻值变化率。</p> |
| <p>Load life in humidity 湿度寿命 (JIS-C 5202 7.9)</p> | <p>Resistance change after 1,000 hours (1.5 hours "ON", 0.5 hours "OFF") at RCWV or Max. Working Voltage whichever less in a humidity test chamber controlled at 40±2°C and 90~95% RH. 持续时间：1,000 小时 (1.5 小时 "通", 0.5 小时 "断"); 试验温度：40±2°C; 相对湿度：90~95%RH; 试验电压：额定工作电压或最大工作电压 (取其低者)。</p> |
| <p>Load life 负载寿命 (JIS-C-5201 4.25.1)</p> | <p>Permanent resistance change after 1,000 hours operating at RCWV or Max. Working Voltage whichever less with duty cycle of 1.5 hours "ON", 0.5 hours "OFF" at 70±2°C ambient 持续时间：1,000 小时 (1.5 小时 "通", 0.5 小时 "断"); 试验温度：70±2°C; 试验电压：额定工作电压或最大工作电压 (取其低者)。</p> |
| <p>Accidental overload 意外过载 (JIS-C-5201 4.26)</p> | <p>Resistors shall resist flaming or arcing when overload up to 5, 10, 16, 25, 40, 63, 100 times power or 4times Max. Working Voltage, whichever less. 施加 5, 10, 16, 25, 40, 63 和 100 倍额定功耗的过负荷, 但所加的电压应不超过 4 倍的最大工作电压, 测试其阻燃性。</p> |
| <p>Flame retardant 阻燃 (JIS-C-5202 7.12)</p> | <p>(Applicable for Flame retardant Resistors) The burner is placed remote from resistor ignited and adjusted to produce a blue flame 38mm in height and a top of flame 127mm above teh top of burner tube. Resistor is supported from its lead at 45°from the horizontal so that the lower end of resistor is the top of blue flame. The test flame is placed to remain for 15 seconds and removed for 15 seconds. The operation is to be repeated until resistor has been subjected to 5 application of test flame. (适用不燃性电阻) 将电阻置于火焰上方蓝烟处 38mm 或火上 127mm 处, 并与水平成 45 度角, 保持 15 秒, 移开 15 秒, 重复 5 次。</p> |

** RCWV = Rated Continuous Working Voltage = $\sqrt{\frac{\text{Rated Power} \times \text{Resistance Value}}{\text{额定功率} \times \text{阻值}}}$ the calculated value or the Max. Working Voltage whichever less. 计算值或该产品最大工作电压取其低者

The below chart shows the nominal resistance value for each series. The values in the chart have been in this order using the approximate values that are based on the common ratios given in the following table:

下表列出每种系列的标准阻值，表中的阻值是按照通用倍率得出的接近阻值。

| Series 系列 | Common Ratio 通用倍率 | Remarks 备注 |
|-----------|-----------------------|---|
| E-6 | $\sqrt[6]{10}(1.46)$ | Rounded off to a 2-digit figure (2 位有效数字) |
| E-12 | $\sqrt[12]{10}(1.21)$ | Rounded off to a 2-digit figure (2 位有效数字) |
| E-24 | $\sqrt[24]{10}(1.10)$ | Rounded off to a 2-digit figure (2 位有效数字) |
| E-96 | $\sqrt[96]{10}(1.02)$ | Rounded off to a 3-digit figure (3 位有效数字) |

| E-6 | E-12 | E-24 | E-96 | E-6 | E-12 | E-24 | E-96 | E-6 | E-12 | E-24 | E-96 | | | | |
|------|------|------|------|------|------|------|------|------|------|------|------|------|------|------|------|
| 1.0 | 1.0 | 1.0 | 1.00 | 2.2 | 2.2 | 2.2 | 2.15 | 4.7 | 4.7 | 4.7 | 4.64 | | | | |
| | | | 1.02 | | | | 2.21 | | | | 4.75 | | | | |
| | | | 1.05 | | | | 2.26 | | | | 4.87 | | | | |
| | | | 1.07 | | | | 2.32 | | | | 4.99 | | | | |
| | | 1.1 | 1.10 | | | 2.4 | 2.37 | | | | 5.1 | 5.11 | | | |
| | | | 1.13 | | | | 2.43 | | | | | 5.23 | | | |
| | | | 1.15 | | | | 2.49 | | | | | 5.36 | | | |
| | | | 1.18 | | | | 2.55 | | | | | 5.49 | | | |
| | | | 1.2 | | | | 1.2 | | | | | 1.2 | 2.61 | 5.6 | 5.62 |
| | | | | | | | | | | | | | 2.67 | | 5.76 |
| | | | | | | | | | | | | | 2.74 | | 5.90 |
| | | | | | | | | | | | | | 2.80 | | 6.04 |
| | 1.3 | | | 1.3 | 3.0 | | 2.87 | | | 6.2 | | 6.19 | | | |
| | | | | | | | 2.94 | | | | | 6.34 | | | |
| | | | | | | | 3.01 | | | | | 6.49 | | | |
| | | | | | | | 3.09 | | | | | 6.65 | | | |
| | 1.5 | 1.5 | 1.5 | 3.16 | 6.8 | 6.8 | 6.81 | | | | | | | | |
| | | | | 3.24 | | | 6.98 | | | | | | | | |
| | | | | 3.32 | | | 7.15 | | | | | | | | |
| | | | | 3.40 | | | 7.32 | | | | | | | | |
| | | | 1.6 | 1.6 | | | 1.6 | | | 3.48 | 7.5 | 7.50 | | | |
| | | | | | | | | | | 3.57 | | 7.68 | | | |
| | | | | | | | | | | 3.65 | | 7.87 | | | |
| | | | | | | | | | | 3.74 | | 8.06 | | | |
| 1.8 | | | | | | | | 1.8 | 1.8 | 3.83 | | 8.2 | 8.25 | | |
| | | | | | | | | | | 3.92 | | | 8.45 | | |
| | | | | 4.02 | | | 8.66 | | | | | | | | |
| | | | | 4.12 | | | 8.87 | | | | | | | | |
| | | 2.0 | | 2.0 | | | 2.0 | | | 4.22 | | | 9.1 | 9.09 | |
| | | | | | | | | | | 4.32 | | | | 9.31 | |
| 4.42 | | | | | | | | 9.53 | | | | | | | |
| 4.53 | | | | | | | | 9.76 | | | | | | | |

标准阻值

E-24 series standard resistance value & the codes to be used in the part No. system 5% & 10% tolerance (4 digits, start with "0"):

E-24 系列标准阻值和料号系统使用代码 (4 位, 以 0 为首位, 5%、10% 公差):

| Value 阻值 | Code 代码 | Value 阻值 | Code 代码 | Value 阻值 | Code 代码 | Value 阻值 | Code 代码 | Value 阻值 | Code 代码 | Value 阻值 | Code 代码 | Value 阻值 | Code 代码 |
|----------|---------|----------|---------|----------|---------|----------|---------|----------|---------|----------|---------|----------|---------|
| 1.0Ω | 010J | 10Ω | 0100 | 100Ω | 0101 | 1.0KΩ | 0102 | 10KΩ | 0103 | 100KΩ | 0104 | 1.0MΩ | 0105 |
| 1.1Ω | 011J | 11Ω | 0110 | 110Ω | 0111 | 1.1KΩ | 0112 | 11KΩ | 0113 | 110KΩ | 0114 | 1.1MΩ | 0115 |
| 1.2Ω | 012J | 12Ω | 0120 | 120Ω | 0121 | 1.2KΩ | 0122 | 12KΩ | 0123 | 120KΩ | 0124 | 1.2MΩ | 0125 |
| 1.3Ω | 013J | 13Ω | 0130 | 130Ω | 0131 | 1.3KΩ | 0132 | 13KΩ | 0133 | 130KΩ | 0134 | 1.3MΩ | 0135 |
| 1.5Ω | 015J | 15Ω | 0150 | 150Ω | 0151 | 1.5KΩ | 0152 | 15KΩ | 0153 | 150KΩ | 0154 | 1.5MΩ | 0155 |
| 1.6Ω | 016J | 16Ω | 0160 | 160Ω | 0161 | 1.6KΩ | 0162 | 16KΩ | 0163 | 160KΩ | 0164 | 1.6MΩ | 0165 |
| 1.8Ω | 018J | 18Ω | 0180 | 180Ω | 0181 | 1.8KΩ | 0182 | 18KΩ | 0183 | 180KΩ | 0184 | 1.8MΩ | 0185 |
| 2.0Ω | 020J | 20Ω | 0200 | 200Ω | 0201 | 2.0KΩ | 0202 | 20KΩ | 0203 | 200KΩ | 0204 | 2.0MΩ | 0205 |
| 2.2Ω | 022J | 22Ω | 0220 | 220Ω | 0221 | 2.2KΩ | 0222 | 22KΩ | 0223 | 220KΩ | 0224 | 2.2MΩ | 0225 |
| 2.4Ω | 024J | 24Ω | 0240 | 240Ω | 0241 | 2.4KΩ | 0242 | 24KΩ | 0243 | 240KΩ | 0244 | 2.4MΩ | 0245 |
| 2.7Ω | 027J | 27Ω | 0270 | 270Ω | 0271 | 2.7KΩ | 0272 | 27KΩ | 0273 | 270KΩ | 0274 | 2.7MΩ | 0275 |
| 3.0Ω | 030J | 30Ω | 0300 | 300Ω | 0301 | 3.0KΩ | 0302 | 30KΩ | 0303 | 300KΩ | 0304 | 3.0MΩ | 0305 |
| 3.3Ω | 033J | 33Ω | 0330 | 330Ω | 0331 | 3.3KΩ | 0332 | 33KΩ | 0333 | 330KΩ | 0334 | 3.3MΩ | 0335 |
| 3.6Ω | 036J | 36Ω | 0360 | 360Ω | 0361 | 3.6KΩ | 0362 | 36KΩ | 0363 | 360KΩ | 0364 | 3.6MΩ | 0365 |
| 3.9Ω | 039J | 39Ω | 0390 | 390Ω | 0391 | 3.9KΩ | 0392 | 39KΩ | 0393 | 390KΩ | 0394 | 3.9MΩ | 0395 |
| 4.3Ω | 043J | 43Ω | 0430 | 430Ω | 0431 | 4.3KΩ | 0432 | 43KΩ | 0433 | 430KΩ | 0434 | 4.3MΩ | 0435 |
| 4.7Ω | 047J | 47Ω | 0470 | 470Ω | 0471 | 4.7KΩ | 0472 | 47KΩ | 0473 | 470KΩ | 0474 | 4.7MΩ | 0475 |
| 5.1Ω | 051J | 51Ω | 0510 | 510Ω | 0511 | 5.1KΩ | 0512 | 51KΩ | 0513 | 510KΩ | 0514 | 5.1MΩ | 0515 |
| 5.6Ω | 056J | 56Ω | 0560 | 560Ω | 0561 | 5.6KΩ | 0562 | 56KΩ | 0563 | 560KΩ | 0564 | 5.6MΩ | 0565 |
| 6.2Ω | 062J | 62Ω | 0620 | 620Ω | 0621 | 6.2KΩ | 0622 | 62KΩ | 0623 | 620KΩ | 0624 | 6.2MΩ | 0625 |
| 6.8Ω | 068J | 68Ω | 0680 | 680Ω | 0681 | 6.8KΩ | 0682 | 68KΩ | 0683 | 680KΩ | 0684 | 6.8MΩ | 0685 |
| 7.5Ω | 075J | 75Ω | 0750 | 750Ω | 0751 | 7.5KΩ | 0752 | 75KΩ | 0753 | 750KΩ | 0754 | 7.5MΩ | 0755 |
| 8.2Ω | 082J | 82Ω | 0820 | 820Ω | 0821 | 8.2KΩ | 0822 | 82KΩ | 0823 | 820KΩ | 0824 | 8.2MΩ | 0825 |
| 9.1Ω | 091J | 91Ω | 0910 | 910Ω | 0911 | 9.1KΩ | 0912 | 91KΩ | 0913 | 910KΩ | 0914 | 9.1MΩ | 0915 |
| | | | | | | | | | | | | 10MΩ | 0106 |

E-96 series standard resistance value & the codes to be used in the part No. system not over 2% tolerance (4 digits):

E-96 系列标准阻值和料号系统使用代码 (4 位, 0.1%、0.25%、0.5%、1%、2% 公差):

| Value 阻值 | Code 代码 | Value 阻值 | Code 代码 | Value 阻值 | Code 代码 | Value 阻值 | Code 代码 | Value 阻值 | Code 代码 | Value 阻值 | Code 代码 | Value 阻值 | Code 代码 | Value 阻值 | Code 代码 |
|----------|---------|----------|---------|----------|---------|----------|---------|----------|---------|----------|---------|----------|---------|----------|---------|
| 10.0Ω | 100J | 17.8Ω | 178J | 31.6Ω | 316J | 56.2Ω | 562J | 100Ω | 1000 | 178Ω | 1780 | 316Ω | 3160 | 562Ω | 5620 |
| 10.2Ω | 102J | 18.2Ω | 182J | 32.4Ω | 324J | 57.6Ω | 576J | 102Ω | 1020 | 182Ω | 1820 | 324Ω | 3240 | 576Ω | 5760 |
| 10.5Ω | 105J | 18.7Ω | 187J | 33.2Ω | 332J | 59.0Ω | 590J | 105Ω | 1050 | 187Ω | 1870 | 332Ω | 3320 | 590Ω | 5900 |
| 10.7Ω | 107J | 19.1Ω | 191J | 34.0Ω | 340J | 60.4Ω | 604J | 107Ω | 1070 | 191Ω | 1910 | 340Ω | 3400 | 604Ω | 6040 |
| 11.0Ω | 110J | 19.6Ω | 196J | 34.8Ω | 348J | 61.9Ω | 619J | 110Ω | 1100 | 196Ω | 1960 | 348Ω | 3480 | 619Ω | 6190 |
| 11.3Ω | 113J | 20.0Ω | 200J | 35.7Ω | 357J | 63.4Ω | 634J | 113Ω | 1130 | 200Ω | 2000 | 357Ω | 3570 | 634Ω | 6340 |
| 11.5Ω | 115J | 20.5Ω | 205J | 36.5Ω | 365J | 64.9Ω | 649J | 115Ω | 1150 | 205Ω | 2050 | 365Ω | 3650 | 649Ω | 6490 |
| 11.8Ω | 118J | 21.0Ω | 210J | 37.4Ω | 374J | 66.5Ω | 665J | 118Ω | 1180 | 210Ω | 2100 | 374Ω | 3740 | 665Ω | 6650 |
| 12.1Ω | 121J | 21.5Ω | 215J | 38.3Ω | 383J | 68.1Ω | 681J | 121Ω | 1210 | 215Ω | 2150 | 383Ω | 3830 | 681Ω | 6810 |
| 12.4Ω | 124J | 22.1Ω | 221J | 39.2Ω | 392J | 69.8Ω | 698J | 124Ω | 1240 | 221Ω | 2210 | 392Ω | 3920 | 698Ω | 6980 |
| 12.7Ω | 127J | 22.6Ω | 226J | 40.2Ω | 402J | 71.5Ω | 715J | 127Ω | 1270 | 226Ω | 2260 | 402Ω | 4020 | 715Ω | 7150 |
| 13.0Ω | 130J | 23.2Ω | 232J | 41.2Ω | 412J | 73.2Ω | 732J | 130Ω | 1300 | 232Ω | 2320 | 412Ω | 4120 | 732Ω | 7320 |
| 13.3Ω | 133J | 23.7Ω | 237J | 42.2Ω | 422J | 75.0Ω | 750J | 133Ω | 1330 | 237Ω | 2370 | 422Ω | 4220 | 750Ω | 7500 |
| 13.7Ω | 137J | 24.3Ω | 243J | 43.2Ω | 432J | 76.8Ω | 768J | 137Ω | 1370 | 243Ω | 2430 | 432Ω | 4320 | 768Ω | 7680 |
| 14.0Ω | 140J | 24.9Ω | 249J | 44.2Ω | 442J | 78.7Ω | 787J | 140Ω | 1400 | 249Ω | 2490 | 442Ω | 4420 | 787Ω | 7870 |
| 14.3Ω | 143J | 25.5Ω | 255J | 45.3Ω | 453J | 80.6Ω | 806J | 143Ω | 1430 | 255Ω | 2550 | 453Ω | 4530 | 806Ω | 8060 |
| 14.7Ω | 147J | 26.1Ω | 261J | 46.4Ω | 464J | 82.5Ω | 825J | 147Ω | 1470 | 261Ω | 2610 | 464Ω | 4640 | 825Ω | 8250 |
| 15.0Ω | 150J | 26.7Ω | 267J | 47.5Ω | 475J | 84.5Ω | 845J | 150Ω | 1500 | 267Ω | 2670 | 475Ω | 4750 | 845Ω | 8450 |
| 15.4Ω | 154J | 27.4Ω | 274J | 48.7Ω | 487J | 86.6Ω | 866J | 154Ω | 1540 | 274Ω | 2740 | 487Ω | 4870 | 866Ω | 8660 |
| 15.8Ω | 158J | 28.0Ω | 280J | 49.9Ω | 499J | 88.7Ω | 887J | 158Ω | 1580 | 280Ω | 2800 | 499Ω | 4990 | 887Ω | 8870 |
| 16.2Ω | 162J | 28.7Ω | 287J | 51.1Ω | 511J | 90.9Ω | 909J | 162Ω | 1620 | 287Ω | 2870 | 511Ω | 5110 | 909Ω | 9090 |
| 16.5Ω | 165J | 29.4Ω | 294J | 52.3Ω | 523J | 93.1Ω | 931J | 165Ω | 1650 | 294Ω | 2940 | 523Ω | 5230 | 931Ω | 9310 |
| 16.9Ω | 169J | 30.1Ω | 301J | 53.6Ω | 536J | 95.3Ω | 953J | 169Ω | 1690 | 301Ω | 3010 | 536Ω | 5360 | 953Ω | 9530 |
| 17.4Ω | 174J | 30.9Ω | 309J | 54.9Ω | 549J | 97.6Ω | 976J | 174Ω | 1740 | 309Ω | 3090 | 549Ω | 5490 | 976Ω | 9760 |

| Value 阻值 | Code 代码 | Value 阻值 | Code 代码 | Value 阻值 | Code 代码 | Value 阻值 | Code 代码 | Value 阻值 | Code 代码 | Value 阻值 | Code 代码 | Value 阻值 | Code 代码 | Value 阻值 | Code 代码 |
|----------|---------|----------|---------|----------|---------|----------|---------|----------|---------|----------|---------|----------|---------|----------|---------|
| 1.00K | 1001 | 2.37K | 2371 | 5.62K | 5621 | 13.3K | 1332 | 31.6K | 3162 | 75.0K | 7502 | 178K | 1783 | 422K | 4223 |
| 1.02K | 1021 | 2.43K | 2431 | 5.76K | 5761 | 13.7K | 1372 | 32.4K | 3242 | 76.8K | 7682 | 182K | 1823 | 432K | 4323 |
| 1.05K | 1051 | 2.49K | 2491 | 5.90K | 5901 | 14.0K | 1402 | 33.2K | 3322 | 78.7K | 7872 | 187K | 1873 | 442K | 4423 |
| 1.07K | 1071 | 2.55K | 2551 | 6.04K | 6041 | 14.3K | 1432 | 34.0K | 3402 | 80.6K | 8062 | 191K | 1913 | 453K | 4533 |
| 1.10K | 1101 | 2.61K | 2611 | 6.19K | 6191 | 14.7K | 1472 | 34.8K | 3482 | 82.5K | 8252 | 196K | 1963 | 464K | 4643 |
| 1.13K | 1131 | 2.67K | 2671 | 6.34K | 6341 | 15.0K | 1502 | 35.7K | 3572 | 84.5K | 8452 | 200K | 2003 | 475K | 4753 |
| 1.15K | 1151 | 2.74K | 2741 | 6.49K | 6491 | 15.4K | 1542 | 36.5K | 3652 | 86.6K | 8662 | 205K | 2053 | 487K | 4873 |
| 1.18K | 1181 | 2.80K | 2801 | 6.65K | 6651 | 15.8K | 1582 | 37.4K | 3742 | 88.7K | 8872 | 210K | 2103 | 499K | 4993 |
| 1.21K | 1211 | 2.87K | 2871 | 6.81K | 6811 | 16.2K | 1622 | 38.3K | 3832 | 90.9K | 9092 | 215K | 2153 | 511K | 5113 |
| 1.24K | 1241 | 2.94K | 2941 | 6.98K | 6981 | 16.5K | 1652 | 39.2K | 3922 | 93.1K | 9312 | 221K | 2213 | 523K | 5233 |
| 1.27K | 1271 | 3.01K | 3011 | 7.15K | 7151 | 16.9K | 1692 | 40.2K | 4022 | 95.3K | 9532 | 226K | 2263 | 536K | 5363 |
| 1.30K | 1301 | 3.09K | 3091 | 7.32K | 7321 | 17.4K | 1742 | 41.2K | 4122 | 97.6K | 9762 | 232K | 2323 | 549K | 5493 |
| 1.33K | 1331 | 3.16K | 3161 | 7.50K | 7501 | 17.8K | 1782 | 42.2K | 4222 | 100K | 1003 | 237K | 2373 | 562K | 5623 |
| 1.37K | 1371 | 3.24K | 3241 | 7.68K | 7681 | 18.2K | 1822 | 43.2K | 4322 | 102K | 1023 | 243K | 2433 | 576K | 5763 |
| 1.40K | 1401 | 3.32K | 3321 | 7.87K | 7871 | 18.7K | 1872 | 44.2K | 4422 | 105K | 1053 | 249K | 2493 | 590K | 5903 |
| 1.43K | 1431 | 3.40K | 3401 | 8.06K | 8061 | 19.1K | 1912 | 45.3K | 4532 | 107K | 1073 | 255K | 2553 | 604K | 6043 |
| 1.47K | 1471 | 3.48K | 3481 | 8.25K | 8251 | 19.6K | 1962 | 46.4K | 4642 | 110K | 1103 | 261K | 2613 | 619K | 6193 |
| 1.50K | 1501 | 3.57K | 3571 | 8.45K | 8451 | 20.0K | 2002 | 47.5K | 4752 | 113K | 1133 | 267K | 2673 | 634K | 6343 |
| 1.54K | 1541 | 3.65K | 3651 | 8.66K | 8661 | 20.5K | 2052 | 48.7K | 4872 | 115K | 1153 | 274K | 2743 | 649K | 6493 |
| 1.58K | 1581 | 3.74K | 3741 | 8.87K | 8871 | 21.0K | 2102 | 49.9K | 4992 | 118K | 1183 | 280K | 2803 | 665K | 6653 |
| 1.62K | 1621 | 3.83K | 3831 | 9.09K | 9091 | 21.5K | 2152 | 51.1K | 5112 | 121K | 1213 | 287K | 2873 | 681K | 6813 |
| 1.65K | 1651 | 3.92K | 3921 | 9.31K | 9311 | 22.1K | 2212 | 52.3K | 5232 | 124K | 1243 | 294K | 2943 | 698K | 6983 |
| 1.69K | 1691 | 4.02K | 4021 | 9.53K | 9531 | 22.6K | 2262 | 53.6K | 5362 | 127K | 1273 | 301K | 3013 | 715K | 7153 |
| 1.74K | 1741 | 4.12K | 4121 | 9.76K | 9761 | 23.2K | 2322 | 54.9K | 5492 | 130K | 1303 | 309K | 3093 | 732K | 7323 |
| 1.78K | 1781 | 4.22K | 4221 | 10.0K | 1002 | 23.7K | 2372 | 56.2K | 5622 | 133K | 1333 | 316K | 3163 | 750K | 7503 |
| 1.82K | 1821 | 4.32K | 4321 | 10.2K | 1022 | 24.3K | 2432 | 57.6K | 5762 | 137K | 1373 | 324K | 3243 | 768K | 7683 |
| 1.87K | 1871 | 4.42K | 4421 | 10.5K | 1052 | 24.9K | 2492 | 59.0K | 5902 | 140K | 1403 | 332K | 3323 | 787K | 7873 |
| 1.91K | 1911 | 4.53K | 4531 | 10.7K | 1072 | 25.5K | 2552 | 60.4K | 6042 | 143K | 1433 | 340K | 3403 | 806K | 8063 |
| 1.96K | 1961 | 4.64K | 4641 | 11.0K | 1102 | 26.1K | 2612 | 61.9K | 6192 | 147K | 1473 | 348K | 3483 | 825K | 8253 |
| 2.00K | 2001 | 4.75K | 4751 | 11.3K | 1132 | 26.7K | 2672 | 63.4K | 6342 | 150K | 1503 | 357K | 3573 | 845K | 8453 |
| 2.05K | 2051 | 4.87K | 4871 | 11.5K | 1152 | 27.4K | 2742 | 64.9K | 6492 | 154K | 1543 | 365K | 3653 | 866K | 8663 |
| 2.10K | 2101 | 4.99K | 4991 | 11.8K | 1182 | 28.0K | 2802 | 66.5K | 6652 | 158K | 1583 | 374K | 3743 | 887K | 8873 |
| 2.15K | 2151 | 5.11K | 5111 | 12.1K | 1212 | 28.7K | 2872 | 68.1K | 6812 | 162K | 1623 | 383K | 3833 | 909K | 9093 |
| 2.21K | 2211 | 5.23K | 5231 | 12.4K | 1242 | 29.4K | 2942 | 69.8K | 6982 | 165K | 1653 | 392K | 3923 | 931K | 9313 |
| 2.26K | 2261 | 5.36K | 5361 | 12.7K | 1272 | 30.1K | 3012 | 71.5K | 7152 | 169K | 1693 | 402K | 4023 | 953K | 9533 |
| 2.32K | 2321 | 5.49K | 5491 | 13.0K | 1302 | 30.9K | 3092 | 73.2K | 7322 | 174K | 1743 | 412K | 4123 | 976K | 9763 |
| | | | | | | | | | | | | | | 1M | 1004 |

** All values shown above are standard resistance values, other values could also be provided on a case to case basis (MOQ requested)

** 以上所有阻值都是标准阻值, 其他阻值可以特别提供, 但有相应 MOQ 之要求。

料号系统注释



The standard Part No. includes 14 digits with the following explanation (标准料号包括 14 位数字, 注释如下):

1. 1st~4th digits (第 1 位 ~ 第 4 位):
 - a) This is to indicate the SMD Resistor size. Example (表示晶片电阻的尺寸, 例如): 1206, TC05 or HV03;
 - b) For Resistor Network & Coated type, the 1st~3rd digits are to indicate the product type and the 4th digit is the special feature. Example: RNLA = Resistor Network Circuit A type; CFRF = Carbon Film Fixed Resistors Non-Flame type; MORI = Metal Oxide Film Fixed Resistor Non-Inductive type.
网络电阻和涂装型电阻第 1 位到第 3 位表示产品类型, 第 4 位表示特殊形态, 如: RNLA = 网络电阻 A 型; CFRF = 不燃性碳膜电阻器; MORI = 无感型金属氧化膜电阻器。
 - c) For Cement Fixed Resistors, these 4 digits are to indicate the product type but if the product type has only 3 digits, the 4th digit will be "0". Example: PRW0=PRW type; PRWC=PRWC type.
水泥型前 4 位表示产品类型, 如果产品只有 3 个字母, 第 4 位为 0, 例: PRW0=PRW 型, PRWC=PRWC 型。

2. 5th~ 6th digits (第 5 位 ~ 第 6 位):
 - a) This is to indicate the wattage or power rating. To distinguish the sizes and the numbers, the following codes are used, and please refer to the following chart for details: W = Normal Size, S = Small Size, U = Ultra Small Size, "1" ~ "G" to denotes "1" ~ "16" as Hexadecimal:
表示产品标识功率, 为区别不同尺寸, 同时使用以下字母, 如: W = 正常尺寸; S = 小尺寸; U = 超小尺寸; "1" ~ "G" 代表 "1" ~ "16" 为 16 进制。

1/16W ~ 1/2W (<1W)

| Wattage 功率 | 1/2 | 1/3 | 1/4 | 1/5 | 1/6 | 1/7 | 1/8 | 1/9 | 1/10 | 1/11 | 1/12 | 1/13 | 1/14 | 1/15 | 1/16 |
|-----------------------|-----|-----|-----|-----|-----|-----|-----|-----|------|------|------|------|------|------|------|
| Normal Size 正常尺寸 | W2 | W3 | W4 | W5 | W6 | W7 | W8 | W9 | WA | WB | WC | WD | WE | WF | WG |
| Small Size 小尺寸 | S2 | S3 | S4 | S5 | S6 | S7 | S8 | S9 | SA | SB | SC | SD | SE | SF | SG |
| Ultra Small Size 超小尺寸 | U2 | U3 | U4 | U5 | U6 | U7 | U8 | U9 | UA | UB | UC | UD | UE | UF | UG |

1W ~ 16W (≥1W)

| Wattage 功率 | 1 | 2 | 3 | 4 | 5 | 6 | 7 | 8 | 9 | 10 | 11 | 12 | 13 | 14 | 15 | 16 |
|-----------------------|----|----|----|----|----|----|----|----|----|----|----|----|----|----|----|----|
| Normal Size 正常尺寸 | 1W | 2W | 3W | 4W | 5W | 6W | 7W | 8W | 9W | AW | BW | CW | DW | EW | FW | GW |
| Small Size 小尺寸 | 1S | 2S | 3S | 4S | 5S | 6S | 7S | 8S | 9S | AS | BS | CS | DS | ES | FS | GS |
| Ultra Small Size 超小尺寸 | 1U | 2U | 3U | 4U | 5U | 6U | 7U | 8U | 9U | AU | BU | CU | DU | EU | FU | GU |

- b) For power rating less than 1W, the 5th digit will be the letters W, S or U to represent the size required & the 6th digit will be a number or a letter code. Example: WA = 1/10W; U2 = 1/2W-SS (功率小于 1 瓦, 第 5 位用 W, S 或 U 表示尺寸要求, 第 6 位将是数字或字母, 例: WA = 1/10W; U2 = 1/2W-SS.)
 - c) For power rating of 1W to 16W, the 5th digit will be a number or a letter code and the 6th digit will be the letters of W, S or U. Example: AW = 10W; 3S = 3W-S. 当功率为 1 到 16 瓦, 第 5 位将是数字或字母, 第 6 位是 W, S 或 U. 例: AW = 10W; 3S = 3W-S.
 - d) For power rating between 20W to 99W, the 5th & 6th digits will show the whole numbers of the power rating itself. Example: 20 = 20W; 75 = 75W. 当功率在 20 瓦 ~ 99 瓦之间第 5 位至第 6 位全部表示功率。例: 20 = 20W; 75 = 75W.
 - e) For power rating of 100W & over, the 5th & 6th digits will be indicated with "00" and the actual wattage being indicated at the last 3 digits (12th~14th) of the Part No. 当大于 100 瓦时第 5 位和第 6 位表示为 "00" 实际功率表示在料号最后 3 位 (12 位 ~ 14 位)
 - f) For special power ratings, the following codes are to be used (特殊功率用下列数字表示):
 - 1). WH = 1/32W (10P8 Chip Network 网络电阻)
 - 2). 07 = 3/4WS [Chip 2010 size (晶片 2010 尺寸)]
 - 3). 04 = 0.4W-SS (0.4 watt Ultra Small size 超小尺寸)
 - 4). 06 = 0.6W-S (0.6 watt Small size 小尺寸)
 - 5). 2A = 2.5W
 - 6). 6A = 6.5W
 - g) For Resistor Network, since the power rating is fixed as 1/8W for A circuit & 1/5W for B circuit, the 5th & 6th digit is to be used to denote the number of pins required. Example: 09 = 9pins; 12 = 12pins. (网络电阻功率固定为 1/8W 或 1/5W, 故第 5 位和第 6 位用来表示所需要的 pins 数. 例: 09 = 9pins; 12 = 12pins.)
 - h) For Jumper Wires the 5th & 6th digits will be indicated with "00". (跳线电阻的第 5 位、第 6 位用 "00" 来表示)
 - i) For Thin Film Chip Resistors, these 2 digits will be used to indicate the requested Temperature coefficient:
对于薄膜晶片电阻产品, 这两位用来表示产品的温度系数要求:
 - 1). 05 = 5PPM
 - 2). 10 = 10PPM
 - 3). 15 = 15PPM
 - 4). 25 = 25PPM
 - 5). 50 = 50PPM
3. The 7th digit is to denote the Resistance Tolerance. The following letter code is to be used for indicating the standard Resistance Tolerance. As for Metal Film Fixed Resistor products, it is also to denote the standard PPM as follows (第 7 位表示阻值误差。下列数码用来表示标准误差, 用于金属膜产品时, 同时用来表示标准 PPM, 如下):

| | |
|--------------------|------------------|
| B = ±0.1% (15PPM) | G = ±2% (100PPM) |
| C = ±0.25% (25PPM) | J = ±5% (200PPM) |
| D = ±0.5% (50PPM) | K = ±10% |
| F = ±1% (50PPM) | |

Remark: if it not one of the above standard "tolerance-TCR", the requirement should be clearly stated when placing order.
Example: ±1% (25PPM), the 7th digit still shows "F" but separately note the requirement of "25PPM"

注: 如果一个不是上述标准 "公差-PPM" 的要表示清楚
例: ±1% (25PPM), 第 7 位要标示 "F" 并另注 "25PPM"

4. The 8th to 11th digits is to denote the Resistance Value (第8位~第11位表示阻值):

- a) For the standard resistance values of E-24 series in 5% & 10% tolerance, the 8th digit is "0", the 9th & 11th digits are to denote the significant figures of the resistance and the 11th digit is the number of zeros following (对于E-24系列的5%、10%产品,第8位数是0,第9位数和第10位数表示阻值的有效数,第11位表示有几个0。)
- b) For the standard resistance values of E-96 series in $\leq 2\%$ tolerance, the 8th digit to the 10th digits are to denote the significant figures of the resistance and the 11th digit is the number of zeros following (对于E-96系列 $\leq 2\%$ 的产品,第8位数到第10位数表示阻值的有效数,第11位数表示有几个0。)
- c) For the code to the significant figures to E-24 & E-96 series, please refer to page 119 & 120 of the standards Resistance Value list.(有效数E-24和E-96系列,请参考119页和120页标准阻值表)
- d) The following numbers and the letter codes is to be used to indicate the number of zeros in the 11th digit:

以下数字及字母用来表示第11位数有几个0:

| | | | | | |
|---------------------|----------------------|----------------------|----------------------|----------------------|----------------------|
| 0 = 10 ⁰ | 1 = 10 ¹ | 2 = 10 ² | 3 = 10 ³ | 4 = 10 ⁴ | 5 = 10 ⁵ |
| 6 = 10 ⁶ | J = 10 ⁻¹ | K = 10 ⁻² | L = 10 ⁻³ | M = 10 ⁻⁴ | N = 10 ⁻⁵ |

- e) For Cement Resistors the 8th digit will be coded with "W" or "P" to denote Wire-wound type or Power Film type respectively of the Cement Fixed Resistor product. The 9th to 11th please refer to point 4.a (水泥电阻第8位数"W"或"P"用来表示绕线型或切割型,第9位数到第11位数请参考4.a)

Example (例):

| E-24 series 系列 | E-96 series 系列 | Cement Resistors 水泥型固定电阻值 |
|----------------|-----------------|------------------------------------|
| 0120 = 12 ohm | 1210 = 121 ohm | W120 = 12 ohm Wire-wound type 绕线型 |
| 0123 = 12K ohm | 1302 = 13K ohm | W12J = 1.2 ohm Wire-wound type 绕线型 |
| 012J = 1.2 ohm | 196J = 19.6 ohm | P273 = 27 kohm Powe Film type 切割型 |

5. The 12th, 13th & 14th digits (第12位数、13位数和14位数):

- a) The 12th digit is to denote the Packaging type with the following codes (第12位数表示包装方式,采用如下代码):
- | | |
|--|--|
| A = Tape / Box (Ammo Pack) [编带/盒装(带装)] | C = Bulk in Cassette (for Chip product)[散装盒(晶片产品)] |
| B = Bulk / Box (散装/盒装) | T = Tape / Reel (编带/卷装) |
| | P = Tape / Box of PT-26 product [编带/盒装(PT-26产品)] |
- b) The 13th digit is normally to indicate the Packing Quantity of Tape/Box or Tape/Reel packaging types. Except for Chip products Bulk packing, this digit should be filled "0" or other products with "Bulk/Box packaging requirement. The following letter codes is to be used for some packaging quantities (第13位数一般表示包装数量对于T/B或T/R型,除了晶片散装外,其他产品的散装包装用"0"表示数量。下列字母说明包装数量。)
- | | | | |
|-------------------|-------------------|-------------------|-------------------|
| A = 500pcs (只) | B = 2,500pcs (只) | C = 10,000pcs (只) | E = 15,000pcs (只) |
| D = 20,000pcs (只) | G = 25,000pcs (只) | H = 50,000pcs (只) | |

Example (例):

| CHIP product (晶片产品) | Other products (其它产品) |
|---------------------|-----------------------|
| TD = T/R-20,000 | A5 = T/B-5,000 |
| TE = T/R-15,000 | TB = T/R-2,500 |
| T4 = T/R-4,000 | BO = B/B (可提供标准包装) |

- c) For the Forming type products, the 13th & 14th digits are used to denote the forming types of the product with the following letter codes (对于成型产品第13位数和第14位数用来表示成型产品,如下字母表示):

| | |
|---|----------------|
| MF = M type with Flattened lead wire (M型打扁加工) | FO = F type 型 |
| MK = M type with Kinked lead wire (M型打弯加工) | F1 = F1 type 型 |
| ML = M type with normal lead wire (M型加工) | F2 = F2 type 型 |
| MC = M type with kinked lead wire (M型打弯加工) | F3 = F3 type 型 |

- d) For power rating over 100watt, the 12th to the 14th digits are to denote the actual wattage of the products (当功率超过100W时,它的第12位数到14位数用来表示产品的实际功率):

Example (例): 100 = 100watt (瓦) 150 = 150watt (瓦) 225 = 225watt (瓦)

- e) For some products, the 14th digit alone can use to denote special features or additional information with the following codes

(对于某些产品第14位可以显示特性和附加信息,如下字母):

| | | |
|---|--|--|
| P = Panasert type (Panasert 型) | 1 = Avisert 1 type (Avisert 1 型) | 2 = Avisert 2 type (Avisert 2 型) |
| 3 = Avisert 3 type (Avisert 3 型) | A = CO 1/4W - A type (切割型 CO 1/4W-A 型) | B = CO 1/4W - B type (切割型 CO 1/4W-B 型) |
| E = used to denote the "Environment Protection, lead Free type" of SMD category resistors (now, this became the Standard type of SMD) (晶片电阻,晶片排阻及网络电阻器“环保无铅型”) | | |

标准色码系统

4 Band Color Code (available for CFR, MOR, KNP & 2% or 5% of MFR products)

4 道色码 (适用于 CFR, MOR, KNP & 2% 或 5% of MFR 产品)



4th Band
第四道

| | |
|----------|--------|
| Red 红 | = ±2% |
| Gold 金 | = ±5% |
| Silver 银 | = ±10% |

1st Band
第一道

| | |
|----------|-----|
| Black 黑 | = 0 |
| Brown 棕 | = 1 |
| Red 红 | = 2 |
| Orange 橙 | = 3 |
| Yellow 黄 | = 4 |
| Green 绿 | = 5 |
| Blue 蓝 | = 6 |
| Violet 紫 | = 7 |
| Gray 灰 | = 8 |
| White 白 | = 9 |

2nd Band
第二道

| | |
|----------|-----|
| Black 黑 | = 0 |
| Brown 棕 | = 1 |
| Red 红 | = 2 |
| Orange 橙 | = 3 |
| Yellow 黄 | = 4 |
| Green 绿 | = 5 |
| Blue 蓝 | = 6 |
| Violet 紫 | = 7 |
| Gray 灰 | = 8 |
| White 白 | = 9 |

3rd Band
第三道

| | |
|----------|--|
| Black 黑 | = Multiply by 乘积倍数 1 (10^0) |
| Brown 棕 | = Multiply by 乘积倍数 10 (10^1) |
| Red 红 | = Multiply by 乘积倍数 100 (10^2) |
| Orange 橙 | = Multiply by 乘积倍数 1,000 (10^3) |
| Yellow 黄 | = Multiply by 乘积倍数 10,000 (10^4) |
| Green 绿 | = Multiply by 乘积倍数 100,000 (10^5) |
| Blue 蓝 | = Multiply by 乘积倍数 1,000,000 (10^6) |
| Violet 紫 | = Multiply by 乘积倍数 10,000,000 (10^7) |
| Gold 金 | = Multiply by 乘积倍数 0.1 (10^{-1}) |
| Silver 银 | = Multiply by 乘积倍数 0.01 (10^{-2}) |

5 Band Color Code (available for MFR 1% & FRN Products)

5 道色码 (适用于 MFR 1% & FRN 产品)



5th Band
第五道

| | |
|----------|----------|
| Violet 紫 | = ±0.1% |
| Blue 蓝 | = ±0.25% |
| Green 绿 | = ±0.5% |
| Brown 棕 | = ±1% |

1st Band
第一道

| | |
|----------|-----|
| Black 黑 | = 0 |
| Brown 棕 | = 1 |
| Red 红 | = 2 |
| Orange 橙 | = 3 |
| Yellow 黄 | = 4 |
| Green 绿 | = 5 |
| Blue 蓝 | = 6 |
| Violet 紫 | = 7 |
| Gray 灰 | = 8 |
| White 白 | = 9 |

2nd Band
第二道

| | |
|----------|-----|
| Black 黑 | = 0 |
| Brown 棕 | = 1 |
| Red 红 | = 2 |
| Orange 橙 | = 3 |
| Yellow 黄 | = 4 |
| Green 绿 | = 5 |
| Blue 蓝 | = 6 |
| Violet 紫 | = 7 |
| Gray 灰 | = 8 |
| White 白 | = 9 |

3rd Band
第三道

| | |
|----------|-----|
| Black 黑 | = 0 |
| Brown 棕 | = 1 |
| Red 红 | = 2 |
| Orange 橙 | = 3 |
| Yellow 黄 | = 4 |
| Green 绿 | = 5 |
| Blue 蓝 | = 6 |
| Violet 紫 | = 7 |
| Gray 灰 | = 8 |
| White 白 | = 9 |

4th Band
第四道

| | |
|----------|--|
| Black 黑 | = Multiply by 乘积倍数 1 (10^0) |
| Brown 棕 | = Multiply by 乘积倍数 10 (10^1) |
| Red 红 | = Multiply by 乘积倍数 100 (10^2) |
| Orange 橙 | = Multiply by 乘积倍数 1,000 (10^3) |
| Yellow 黄 | = Multiply by 乘积倍数 10,000 (10^4) |
| Green 绿 | = Multiply by 乘积倍数 100,000 (10^5) |
| Blue 蓝 | = Multiply by 乘积倍数 1,000,000 (10^6) |
| Violet 紫 | = Multiply by 乘积倍数 10,000,000 (10^7) |
| Gold 金 | = Multiply by 乘积倍数 0.1 (10^{-1}) |
| Silver 银 | = Multiply by 乘积倍数 0.01 (10^{-2}) |

A series of horizontal dashed lines for writing, spanning the width of the page.



Uniroyal Electronics Industry Co., Ltd.

厚声电子工业有限公司

21 Xiajia North Road, Economic & Technical Development Zone,
Kunshan City, Jiangsu, CHINA 215334

中国江苏省昆山市经济技术开发区夏驾北路 21 号
邮编：215334

Tel: +86 512 5763 1400 / 1411 / 1422 / 1433

fax: +86 512 5763 4599

localsales@uniohm.com

globalsales@uniohm.com

www.uniohm.com

X-ON Electronics

Largest Supplier of Electrical and Electronic Components

Click to view similar products for [Thick Film Resistors - SMD category](#):

Click to view products by [Uniroyal manufacturer](#):

Other Similar products are found below :

[CRCW04028R20JNEE](#) [CRCW06036K80FKEE](#) [CRG1206F1K58](#) [CRL0603-FW-R700ELF](#) [M55342K06B6E19RWL](#) [RC1005F1072CS](#)
[RC1005F471CS](#) [RC1005F4751CS](#) [RCP0603W100RGED](#) [RCWP72251K47FKWB](#) [RLR05C7501GPB14](#) [RLR07C5111FSBSL](#) [ERJ-](#)
[1GMF1R00C](#) [ERJ-1GMF1R20C](#) [ERJ-1GMF2R55C](#) [ERJ-1GMF8R66C](#) [25121WF1003T4E](#) [25.501.3653.0](#) [290-1.0M-RC](#) [292-1.0M-RC](#) [292-](#)
[2.2K-RC](#) [292-4.7K-RC](#) [25121WF4700T4E](#) [292-470K-RC](#) [302-1.0M-RC](#) [CPG1206F10KC](#) [CRCW02011R00FXED](#) [CRCW060315K0FKEE](#)
[CRCW060320K5FKEE](#) [CRG0201F10K](#) [RCG0402150RFKED](#) [RCG04023K92FKED](#) [RCP2512B100RGWB](#) [RCWP110010R0FKS3](#)
[RCWP11002K00FKS3](#) [RCWP12061K00FKS2](#) [3520510RJT](#) [352075KJT](#) [M55342K11B9E53RUL](#) [RMC16-102JT](#) [RMC1JPTE](#) [TR0603MR-](#)
[075K1L](#) [5-2176094-4](#) [35202K7JT](#) [WF06Q1000FTL](#) [ERJ-S03J1R0V](#) [ERJ-S14J4R7U](#) [CHP2512L4R30GNT](#) [CPCC10270R0JE32](#)
[RCWP11001K00FKS3](#)