

# UniOhm

Uniroyal Electronics Industry Co., Ltd.

厚声电子工业有限公司

2013 - 2014



# *UniOhm*

**Uniroyal Electronics Industry Co., Ltd.**

**厚声电子工业有限公司**

21 Xiajia North Road, Economic & Technical Development Zone,  
Kunshan City, Jiangsu, CHINA 215334

中国江苏省昆山市经济技术开发区夏驾北路 21 号  
邮编 : 215334

Tel: +86 512 5763 1400 / 1411 / 1422 / 1433

fax: +86 512 5763 4599

localsales@uniohm.com

globalsales@uniohm.com

[www.uniohm.com](http://www.uniohm.com)

Surface Mount Category - CHIP, CHIP ARRAY & CHIP NETWORK Resistors (表面贴装式 – 晶片电阻, 晶片排列电阻及晶片网络电阻器)

	Thick Film Chip Resistors 厚膜晶片电阻器	3	O1005, O201, O402, O603, O805, 1206, 1210, 1812, 2010, 2512
	High Resistance Thick Film Chip Resistors 高阻厚膜晶片电阻器	6	O603, O805, 1206, 1210
	Anti-Surge Thick Film Chip Resistors 抗浪涌厚膜晶片电阻器	7	AS03, AS05, AS06, AS07
<b>New</b>	High-Precision Anti-Surge Thick Film Chip Resistors - PS 高精度抗浪涌厚膜晶片电阻器 - PS	9	PS05, PS06, PS07
	High-Power Thick Film Chip Resistors 高功率厚膜晶片电阻器	11	HP02, HP03, HP05, HP06, HP07, HP10, HP12
	Low Resistance High-Power Thick F.C.R. 高功率低阻值厚膜晶片电阻器	13	HP03, HP05, HP06, HP07, HP10, HP12
	High-Voltage Thick Film Chip Resistors 高压厚膜晶片电阻器	14	HV03, HV05, HV06, HV07, HV10, HV12
	Wide-Terminal Thick Film Chip Resistors 宽电极厚膜晶片电阻器	16	O508, O612, 1020, 1218, 1225
	Trimable Thick Film Chip Resistors 可调厚膜晶片电阻器	18	TR03, TR05, TR06
	Current Sensing Chip Resistors 晶片电流检测电阻器	20	CS03, CS05, CS06, CS07, CS10, CS12
<b>New</b>	AEC-Q200 Version Chip Resistors - HQ 汽车用晶片电阻 -HQ	22	HQ02, HQ03, HQ05, HQ06, HQ07, HQ10, HQ12
<b>New</b>	Non-magnetic Thick Film Chip Resistors - NM 无磁厚膜晶片电阻器 - NM	24	NM02, NM03, NM05
<b>New</b>	Anti-Sulfurized Thick Film Chip Resistors - NS 抗硫化厚膜晶片电阻器 - NS	26	NS03, NS05, NS06
<b>New</b>	Flex LED Strip use Thick Film Chip Resistors - LE 软灯条专用电阻器 - LE	28	LE06
	High-Precision Thin Film Chip Resistors 高精度薄膜晶片电阻器	30	TC02, TC03, TC05, TC06, TC07, TC10, TC12
	High Power Thin Film Chip Resistors 高功率薄膜晶片电阻器	32	TP03, TP05, TP06
	Thin Film Chip Resistors 薄膜晶片电阻器	33	TC02, TC03, TC05, TC06
	Chip Resistors Array - Convex Terminal 晶片排列电阻器 – 凸式电极	34	2D02, 4D02, 4D03, 16P8
	Chip Resistors Array - Concave Terminal 晶片排列电阻器 – 凹式电极	35	2C02, 4C02, 4C03
	Thick Film Chip Resistors Network 厚膜晶片网络电阻器	36	10P8, 10S8, 10T8, 10E9
	Packing of Surface Mount Resistors 表面贴装式电阻器包装	37	Packing of Surface Mount Resistors

Through Hole Category - Network Resistors & Traditional Coated Resistors (插件式 – 排列电阻 & 涂装型电阻)

	Resistor Network - SIP Series 网络电阻器 - SIP 系列	38	RNL-A, RNL-B, RNL-C, RNL-D, RNL-E, RNL-L, RNL-R, RNL-G, RNL-P
	High Power Resistor Network - SIP RPL Series 高功率网络电阻器 - SIP RPL 系列	40	RPL-A, RPL-B, RPL-R
	High Power Resistors Network Medium Profile—SIP RNM Series 高功率中宽度网络电阻器 - SIP RNM 系列	42	RNM-A, RNM-B, RNM-R
	High Power Resistors Network High Profile—SIP RPH Series 高功率高宽度网络电阻器 - SIP RPH 系列	44	RPH-A, RPH-B, RPH-R
	Special Network –SIP Series 特殊网络电阻器 - SIP 系列	46	SN0001, SN0002, SN0003, SN0004
	Resistor/Capacitor Network-SIP Series 网络阻容器电阻器 - SIP 系列	47	RCN-A, RCN-B
	Capacitor Network-SIP Series 网络电容器 - SIP 系列	48	CNM-1
	High Voltage Flat Resistors 高压扁平式电阻器	49	HFR
	Carbon Film Fixed Resistors 碳膜电阻器	50	CFR
	Precision Metal Film Fixed Resistors 精密金属膜电阻器	52	MFR
	Carbon Film Power Resistors 高功率碳膜电阻器	54	CPR
	Metal Film Power Resistors 高功率金属膜电阻器	55	MPR
	Metal Oxide Film Fixed Resistors 金属氧化膜固定电阻器	56	MOR
	Wire-wound Fixed Resistors 绕线型固定电阻器	58	KNP, KNH, KNS
<b>New</b>	Wire-Wound Anti Surge Fixed Resistors 绕线耐脉冲电阻器	60	KSR
	Wire-wound Power Resistors 高功率绕线型固定电阻器	61	WPR
	Fusible Resistors 保险丝电阻器	62	FRN
	Wire-wound Fusible Resistors 绕线保险丝型电阻器	64	KFR
	Thermal Fusing Wire-wound Fixed Resistors 绕线型温度保险丝电阻器	66	TFR
	Current Sense Resistors 电流检测线电阻器	67	CSR
<b>New</b>	Current Sense Spring Resistors 弹簧式电流检测电阻器	68	CSSA, CSSB, CSSC
	Metal Glaze Film Fixed Resistors 金属玻璃釉膜固定电阻器	69	MGR

High-Value Metal Glaze Film Fixed Resistors 超高阻玻璃釉膜固定电阻器	71	HMGR
High-Voltage Metal Glaze Film Fixed Resistors 耐高压型玻璃釉膜固定电阻器	72	HVR
Terminal Type Metal Oxide Film Resistors 端片型金属氧化膜电阻器	73	TMOR, TMOV, TMOL
Jumper Wires & Zero-Ohm Resistors 跳线及零欧姆电阻器	74	ZW, ZO, ZF
Copper Plated Steel Lead Wire Type & Cutting Type 铜包钢导线型及切割半成品型	75	CP, CO
Panasert Type (Panasert 型)	76	
Avisert Type (Avisert 型)	77	AVI-1, AVI-2, AVI-3
M & F Forming Type (M 型 & F 型 < 成型 >)	79	MF, MK, ML, F, F1, F2, F3
Standard Packing of Coated Type Resistors 涂装型电阻器包装标准	81	Tape/Box, Tape/Reel, Bulk/Box

## Through Hole Category - Traditional Cement Resistors ( 插件式 - 水泥型电阻 )

Axial Leaded Terminal Type-PRW Series 轴式导线型 - PRW 系列	87	PRW, PRWA, PRWC
Radial Leaded Type-PRM & PRS Series 立式导线型 - PRM & PRS 系列	88	PRM, PRMA, PRMB, PRMT, PRS
Radial Terminal Type - PRV Series 立式端片型 - PRV 系列	89	PRVA, PRVB
Radial Terminal Type - PRZ Series 立式端片型 - PRZ 系列	90	PRZA, PRZA-1, PRZC, PRZC-1, PRZD
Radial Terminal Type - PRT & PRU Series 立式端片型 - PRT & PRU 系列	91	PRT, PRU, PRU-1
<b>New</b> Radial Terminal Type - PRTM Series 立式端片型 - PRTM 系列	93	PRTM
Leaded Type Cement Thermal Fusing Resistors 导线型水泥保险丝电阻器	94	FTR, PHF, PHF1, PHF2
Ultra-Low Value Cement Resistors 超低阻水泥固定电阻器	96	PRWU
Power Flat Alloy Resistors 功率型合金箔电阻器	97	PFAS, PFAT
Columnar Type Cement Fixed Resistors 圆柱状水泥电阻器	99	QHO
Standard Packing of Cement Type Resistors 水泥型电阻器包装标准	100	Bulk/Box

## Power Type Resistors ( 功率型 )

Power Dissipation Mount Resistors 铝外壳电阻器	103	PDM
High-Power Wire-wound Resistors 高功率绕线型固定电阻器	104	BTR
High-Power Flat Wire-wound Fixed Resistors 高功率扁平型绕线固定电阻器	105	KNHB
Multi-Leaded Wire-wound Resistors 多引线型绕线固定电阻器	106	KNHW
High-Power Wire-wound Resistors 高功率绕线型固定电阻器	107	HAWR
<b>New</b> High Power Wire Wound Flat aluminum shell Fixed Resistors 高功率绕线扁平铝壳电阻器	108	HPWR
<b>New</b> High Power Wire Wound Trapezoid aluminum shell Fixed Resistors 高功率绕线梯形铝壳电阻器	109	HPAR
<b>New</b> High Power Wire Wound Iron shell Fixed Resistors 高功率绕线铁壳固定电阻器	110	HPWR
High-Temperature Wire-wound Resistors 高温绕线固定电阻器	111	HAWF
Bilaeteral Cement Resistors 双体水泥固定电阻	112	BCR
Vitreous Enameled Wire-wound Resistors 珐琅釉绕线固定电阻器	113	URX
Power Type Thermal Fusing Resistors 功率型温度保险丝电阻	114	TFO, TFRC
Power (Ribbon) Wire-wound Resistors 功率 (合金带) 绕线型电阻器	115	QH, QL, QR, QRZG

## RELATIVE INFORMATION ( 相关资料 )

Test Method of JIS-C-5201 & JIS-C-5202 JIS-C-5201 和 JIS-C-5202 检测方法	117	
Standard Nominal Resistance Value 标准电阻值	118	
Explnation of Part No. System 料号系统注释	121	
Standard Color Code System 标准色码系统	123	

### Feature (特性)

- Small size & light weight 短小轻薄
- Reduction of assembly costs and matching with placement machine. 可降低装置成本及配合机器组装
- Suitable for both wave & re-flow soldering. 适合波峰焊与回流焊
- Applications: Navigator (GPS), Mobile Phone, Telecom, PDA, Setbox, Meter.  
应用于GPS, 移动电话, PDA, 机顶盒, 仪表



### Figures (型状)

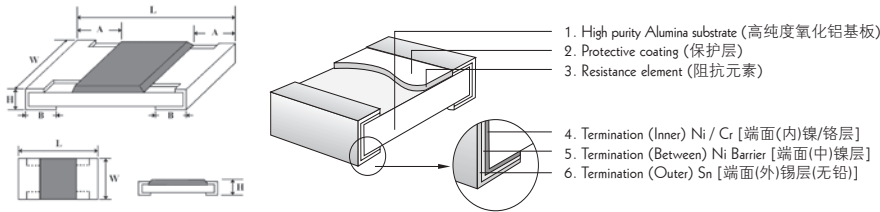

### Derating Curve & Specification

#### 降功率曲线及性能

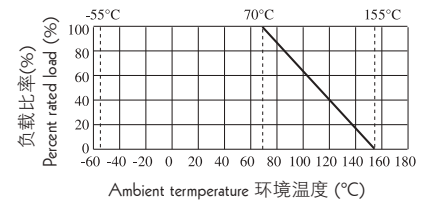

Type 类型	01005 <small>New</small>	0201	0402	0603	0805	1206	1210	1812	2010	2512
Max. Working Voltage 最大工作电压	15V	25V	50V	50V	150V	200V	200V	200V	200V	200V
Max. Overload Voltage 最大过负荷电压	30V	50V	100V	100V	300V	400V	500V	500V	500V	500V
Dielectric withstanding Voltage 绝缘耐压	-	-	100V	300V	500V	500V	500V	500V	500V	500V
Operating Temperature 工作温度范围	-55~+155°C	-55~+155°C	-55~+155°C	-55~+155°C	-55~+155°C	-55~+155°C	-55~+155°C	-55~+155°C	-55~+155°C	-55~+155°C

Type 类型	01005 <small>New</small>	0201	0402	0603	0805	1206	1210	1812	2010	2512
Power Rating at 70°C 功率	1/32W	1/20W	1/16W	1/16W (1/10W-S)	1/10W (1/8W-S)	1/8W (1/4W-S)	1/4W (1/3W-S 1/2W-SS) *	1/2W (3/4W-S)	1/2W (3/4W-S)	1W
L (mm)	0.40 ± 0.02	0.60 ± 0.03	1.00 ± 0.10	1.60 ± 0.10	2.00 ± 0.15	3.10 ± 0.15	3.10 ± 0.10	4.50 ± 0.20	5.00 ± 0.10	6.35 ± 0.10
W (mm)	0.20 ± 0.02	0.30 ± 0.03	0.50 ± 0.05	0.80 <sup>+0.15</sup> <sub>-0.10</sub>	1.25 <sup>+0.15</sup> <sub>-0.10</sub>	1.55 <sup>+0.15</sup> <sub>-0.10</sub>	2.60 <sup>+0.15</sup> <sub>-0.10</sub>	3.20 ± 0.20	2.50 <sup>+0.15</sup> <sub>-0.10</sub>	3.20 <sup>+0.15</sup> <sub>-0.10</sub>
H (mm)	0.13 ± 0.02	0.23 ± 0.03	0.35 ± 0.05	0.45 ± 0.10	0.55 ± 0.10	0.55 ± 0.10	0.55 ± 0.10	0.55 ± 0.20	0.55 ± 0.10	0.55 ± 0.10
A (mm)	0.10 ± 0.05	0.10 ± 0.05	0.20 ± 0.10	0.30 ± 0.20	0.40 ± 0.20	0.45 ± 0.20	0.50 ± 0.25	0.50 ± 0.20	0.60 ± 0.25	0.60 ± 0.25
B (mm)	0.10 ± 0.03	0.15 ± 0.05	0.25 ± 0.10	0.30 ± 0.20	0.40 ± 0.20	0.45 ± 0.20	0.50 ± 0.20	0.50 ± 0.20	0.50 ± 0.20	0.50 ± 0.20
Resistance Value of Jumper 零欧姆电阻阻值	-	<50mΩ	<50mΩ	<50mΩ	<50mΩ	<50mΩ	<50mΩ	<50mΩ	<50mΩ	<50mΩ
Rated Current of Jumper 零欧姆电阻额定电流	-	0.5A	1A	1A	2A	2A	2A	2A	2A	2A
Max. Current of Jumper 零欧姆电阻最大电流	-	1A	2A	2A	5A	10A	10A	10A	10A	10A
Resistance Range of 0.5% (E-96) 0.5% 的阻值范围(E-96)	-	-	1Ω ~ 10MΩ	1Ω ~ 10MΩ	1Ω ~ 10MΩ	1Ω ~ 10MΩ	1Ω ~ 10MΩ	1Ω ~ 10MΩ	1Ω ~ 10MΩ	1Ω ~ 10MΩ
Resistance Range of 1% (E-96) 1% 的阻值范围 (E-96)	10Ω ~ 10MΩ	1Ω ~ 10MΩ	1Ω ~ 10MΩ	1Ω ~ 10MΩ	1Ω ~ 10MΩ	1Ω ~ 10MΩ	1Ω ~ 10MΩ	1Ω ~ 10MΩ	1Ω ~ 10MΩ	1Ω ~ 10MΩ
Resistance Range of 2% (E-24) 2% 的阻值范围 (E-24)	10Ω ~ 10MΩ	1Ω ~ 10MΩ	1Ω ~ 10MΩ	1Ω ~ 10MΩ	1Ω ~ 10MΩ	1Ω ~ 10MΩ	1Ω ~ 10MΩ	1Ω ~ 10MΩ	1Ω ~ 10MΩ	1Ω ~ 10MΩ
Resistance Range of 5% (E-24) 5% 的阻值范围 (E-24)	10Ω ~ 10MΩ	1Ω ~ 10MΩ	1Ω ~ 10MΩ	1Ω ~ 10MΩ	1Ω ~ 10MΩ	1Ω ~ 10MΩ	1Ω ~ 10MΩ	1Ω ~ 10MΩ	1Ω ~ 10MΩ	1Ω ~ 10MΩ

Marking on the Resistors Body (电阻本体字码标示)

- For 0201 & 0402 size, no marking on the body due to the small size of the resistor.  
0201, 0402因电阻本体太小, 故本体无标示字码
- ±5% tolerance product: the marking is 3 digits, the first 2 digits are the significant of the resistance and the 3rd digit denotes number of zeros following.  
±5%公差产品字码是三位数, 前二位是阻值的有效数, 第三位表示有几个0
- 0805, 1206, 1210, 2010, 2512 ≤±1%: the marking is 4 digits, the first 3 digits are the significant of the resistance and the 4th digit denotes number of zeros following.  
0805, 1206, 1210, 2010, 2512 ≤±1%公差产品字码有四位数字, 前三位是阻值的有效数, 第四位表示有几个0
- Standard E-96 series values of 0603 ≤±1%: due to the small size of the resistor's body, 3 digits marking will be used to indicate the accurate resistance value by using the following Multiplier & Resistance Code.  
0603 ≤±1%公差 E-96系列标准阻值, 因电阻本体太小, 采用三位阻值代码(数字)及下列指数代码(字母)配合来指明标准的阻值。



153 = 15000Ω = 15KΩ



Below 10Ω: 6R8 = 6.8Ω  
10Ω 以下标示: 6R8 = 6.8Ω



2372 = 23700Ω = 23.7KΩ



Below 10Ω: 3R24 = 3.24Ω  
10Ω 以下标示: 3R24 = 3.24Ω

Multiplier Code (for 0603 ≤±1% marking) [指数码 (0603≤±1% 标示)]

Code 代码	A	B	C	D	E	F	G	H	X	Y	Z
Multiplier 指数	10 <sup>0</sup>	10 <sup>1</sup>	10 <sup>2</sup>	10 <sup>3</sup>	10 <sup>4</sup>	10 <sup>5</sup>	10 <sup>6</sup>	10 <sup>7</sup>	10 <sup>-1</sup>	10 <sup>-2</sup>	10 <sup>-3</sup>

Standard E-96 series Resistance Value code (for 0603 ≤±1% marking) [E-96系列标准阻值代码 (对0603≤±1%的字码)]

Value 阻值	Code 代码	Value 阻值	Code 代码	Value 阻值	Code 代码	Value 阻值	Code 代码	Value 阻值	Code 代码	Value 阻值	Code 代码
100	01	147	17	215	33	316	49	464	65	681	81
102	02	150	18	221	34	324	50	475	66	698	82
105	03	154	19	226	35	332	51	487	67	715	83
107	04	158	20	232	36	340	52	499	68	732	84
110	05	162	21	237	37	348	53	511	69	750	85
113	06	165	22	243	38	357	54	523	70	768	86
115	07	169	23	249	39	365	55	536	71	787	87
118	08	174	24	255	40	374	56	549	72	806	88
121	09	178	25	261	41	383	57	562	73	825	89
124	10	182	26	267	42	392	58	576	74	845	90
127	11	187	27	274	43	402	59	590	75	866	91
130	12	191	28	280	44	412	60	604	76	887	92
133	13	196	29	287	45	422	61	619	77	909	93
137	14	200	30	294	46	432	62	634	78	931	94
140	15	205	31	301	47	442	63	649	79	953	95
143	16	210	32	309	48	453	64	665	80	976	96

So the resistance value are marked as the following examples (阻值标示如下):



1.96KΩ = 196 × 10<sup>1</sup> Ω = 29B



12.4Ω = 124 × 10<sup>-1</sup> = 10X

- Standard E-24 and not belong to E-96 series values (≤±1%) of 0603 size: the marking is the same as 5% tolerance but marking as underline.  
0603≤±1%公差, 在标准 E-24 系列中, 但不属 E-96 系列的阻值, 标示和5%的公差相同, 但是在字码下多加一条线



122 = 1200 = 1.2 KΩ



680 = 68Ω

### Performance Specifications (性能)

Temperature coefficient	温度系数	01005: $\pm 250\text{PPM}/^\circ\text{C}$ $1\Omega \sim 10\Omega \leq \pm 400\text{PPM}/^\circ\text{C}$ $11\Omega \sim 100\Omega \leq \pm 200\text{PPM}/^\circ\text{C}$ $> 100\Omega \pm 100\text{PPM}/^\circ\text{C}$ (0201 $> 100\Omega \pm 200\text{PPM}/^\circ\text{C}$ ) Provided Specially (特别提供): 0402: $\pm 0.5\%$ 100 $\Omega \sim 1\text{M}$ : $\pm 50\text{PPM}/^\circ\text{C}$ 0603: $1\Omega \sim 10\Omega$ : $\pm 200\text{PPM}/^\circ\text{C}$ 0805, 1206: $1\Omega \sim 10\Omega$ : $\pm 100\text{PPM}/^\circ\text{C}$
Short-time overload	短时间过负荷	$\pm 5\%$ , $\pm 2\%$ : $\pm(2.0\% + 0.1\Omega)$ Max(最大). $\pm 1\%$ , $\pm 0.5\%$ : $\pm(1.0\% + 0.1\Omega)$ Max(最大).
Insulation resistance	绝缘电阻	$\geq 1,000\text{ M}\Omega$
Dielectric withstanding voltage	绝缘耐压	No evidence of flashover, mechanical damage, arcing or insulation breakdown 无击穿, 飞弧及可见机械性损伤
Terminal bending	端子弯曲	$\pm(1.0\% + 0.05\Omega)$ Max(最大).
Soldering heat	耐焊接热	$\pm(1.0\% + 0.05\Omega)$ Max(最大).
Solderability	可焊性	Min. 95% coverage (最少 95% 覆盖率)
Temperature cycling	温度循环	$\pm 5\%$ , $\pm 2\%$ : $\pm(1.0\% + 0.05\Omega)$ Max(最大). $\pm 1\%$ , $\pm 0.5\%$ : $\pm(0.5\% + 0.05\Omega)$ Max(最大).
Humidity (Steady State)	恒定湿热	$\pm 5\%$ , $\pm 2\%$ : $\pm(3.0\% + 0.1\Omega)$ Max(最大). $\pm 1\%$ , $\pm 0.5\%$ : $\pm(0.5\% + 0.1\Omega)$ Max(最大).
Load life in humidity	湿度寿命	$\pm 5\%$ , $\pm 2\%$ : $\pm(3.0\% + 0.1\Omega)$ Max(最大). $\pm 1\%$ , $\pm 0.5\%$ : $\pm(1.0\% + 0.1\Omega)$ Max(最大).
Load life	负载寿命	$\pm 5\%$ , $\pm 2\%$ : $\pm(3.0\% + 0.1\Omega)$ Max(最大). $\pm 1\%$ , $\pm 0.5\%$ : $\pm(1.0\% + 0.1\Omega)$ Max(最大).

• The values which are not of standard E-24 series (2% & 5%) and not of E-96 series (1%) could be offered on a case to case basis.  
 阻值如不在 E-24 系列 (2% & 5%) 及 E-96 系列 (1%) 可特别提供

### Ordering Procedure (Example: 1206 1/4W-S 5% 1.2 $\Omega$ T/R-5000)

订购方式 (例如: 1206 1/4W-S 5% 1.2  $\Omega$  T/R-5000)

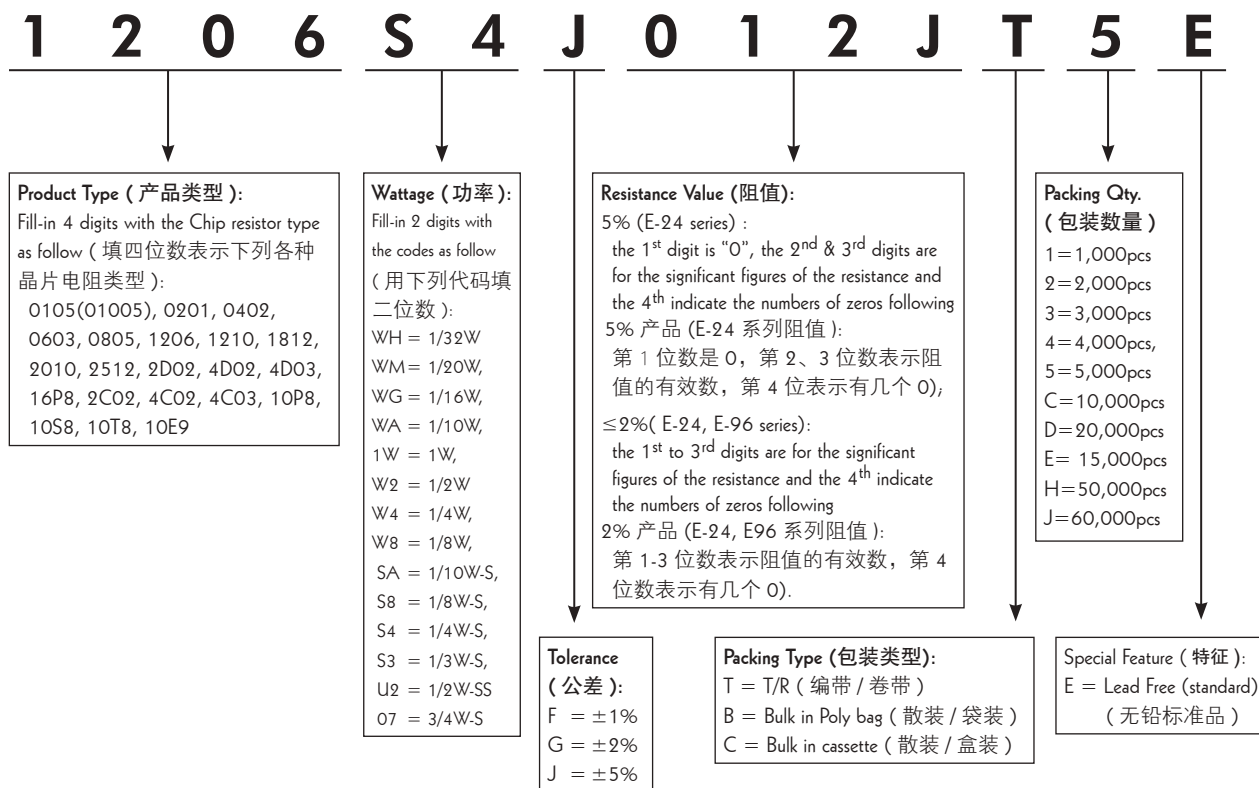

Feature (特性)

- High Resistance 高阻值
- Suitable for reflow & wave soldering  
适合波峰焊与回流焊
- Application AV adapters, LCD back-light camera strobe etc. 适用于AV适配器, LCD背光电路, 照相机快门等.

Figures (型状)

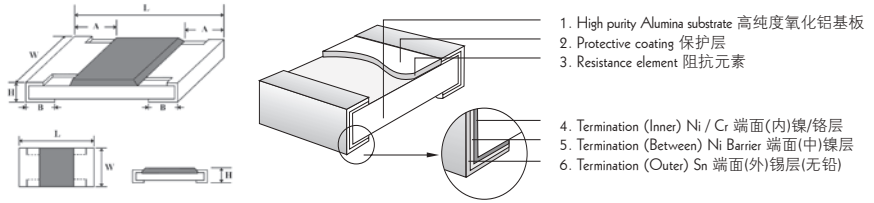

Derating Curve & Specification (降功率曲线及性能)

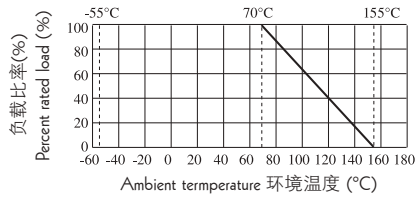

Type 类型	Max Working Voltage 最大工作电压	Max Overload Voltage 最大过负荷电压	Dielectric Withstanding Voltage 绝缘耐压	Operating Temperature Range 工作温度范围
0603	50V	100V	300V	-55~+155°C
0805	150V	300V	500V	
1206	200V	400V	500V	
1210	200V	400V	500V	

Type 类型	Power (功率) (70°C)	L (mm)	W (mm)	H (mm)	A (mm)	B (mm)	Resistance Range (阻值范围) 5% (E24)
0603	1/16W 1/10W-S	1.60±0.10	0.80 <sup>+0.15</sup> <sub>-0.10</sub>	0.45±0.10	0.30±0.20	0.30±0.20	10M~100M
0805	1/10W 1/8W-S	2.00±0.15	1.25 <sup>+0.15</sup> <sub>-0.10</sub>	0.55±0.10	0.40±0.20	0.40±0.20	
1206	1/8W 1/4W-S	3.10±0.15	1.55 <sup>+0.15</sup> <sub>-0.10</sub>	0.55±0.10	0.45±0.20	0.45±0.20	
1210	1/4W 1/2W-SS	3.10±0.10	2.60 <sup>+0.15</sup> <sub>-0.10</sub>	0.55±0.10	0.50±0.25	0.50±0.20	

Performance Specification (性能)

Temperature coefficient	温度系数	±200ppm/°C
Short time overload	短时间过负荷	±(2.0%+0.1Ω) Max (最大)
Terminal bending	端子弯曲	±(1.0%+0.05Ω)
Solderability	可焊性	Min 95% coverage (最少 95% 覆盖率)
Dielectric withstanding voltage	绝缘耐压	No evidence of flashover, mechanical damage, arcing or insulation breakdown (无击穿, 飞弧及可见机械性损伤)
Soldering heat	耐焊接热	±(1.0%+0.05Ω) Max (最大)
Temperature cycling	温度循环	±(1.0%+0.05Ω) Max (最大)
Load Life in humidity	湿度寿命	±(3.0%+0.1Ω) Max (最大)
Load life	负载寿命	±(3.0%+0.1Ω) Max (最大)
Humidity (steady state)	恒定湿热	±(3.0%+0.1Ω) Max (最大)
Insulation resistance	绝缘电阻	≥1,000 MΩ



### Feature (特性)

- Superior Anti-Surge Voltage performance.  
优越的抗浪涌电压特性
- Suitable for both wave & re-flow soldering  
适合波峰焊与回流焊
- Application AV adapters, LCD back-light camera strobe etc. 适用于AV适配器、LCD背光电路、照相机的快门等

### Figures (型状)

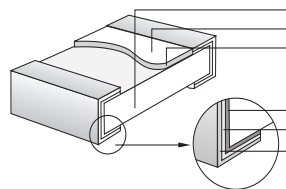
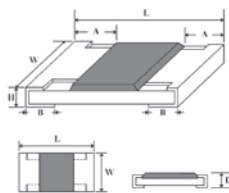

1. High purity Alumina substrate (高纯度氧化铝基板)
2. Protective coating (保护层)
3. Resistance element (阻抗元素)
4. Termination (Inner) Ni / Cr [端面(内)镍/铬层]
5. Termination (Between) Ni Barrier [端面(中)镍层]
6. Termination (Outer) Sn [端面(外)锡层(无铅)]

### Derating Curve (降功率曲线)

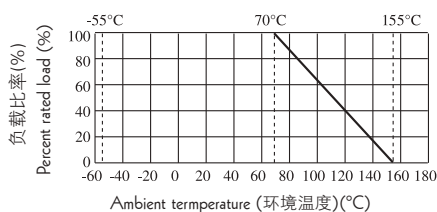

### Curve of Pulse Duration (脉冲曲线)

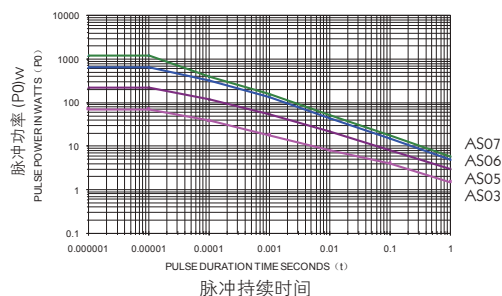

### Specification (规格)

Type 类型	Max. Working Voltage 最大工作电压	Max. Overload Voltage 最大过负荷电压	Dielectric Withstanding Voltage 绝缘耐压	Operating Temperature 工作温度范围
AS03	50V	100V	300V	-55~+155°C
AS05	150V	300V	500V	
AS06	200V	400V	500V	
AS07	200V	400V	500V	

Type 类型	Power (功率) (70°C)	L (mm)	W (mm)	H (mm)	A (mm)	B (mm)	Resistance Range 阻值范围	Tolerance 公差
AS03	1/5W, 1/4W-S	1.60±0.10	0.80 <sup>+0.15</sup> <sub>-0.10</sub>	0.45±0.10	0.30±0.20	0.30±0.20	1Ω~10M	±5% ±10% ±20%
AS05	1/3W, 1/2W-S	2.00±0.15	1.25 <sup>+0.15</sup> <sub>-0.10</sub>	0.55±0.10	0.40±0.20	0.40±0.20		
AS06	1/2W, 0.6W-S	3.10±0.15	1.55 <sup>+0.15</sup> <sub>-0.10</sub>	0.55±0.10	0.45±0.20	0.45±0.20		
AS07	1/2W, 3/4W-S	3.10±0.10	2.60 <sup>+0.15</sup> <sub>-0.10</sub>	0.55±0.10	0.50±0.25	0.50±0.20		

Performance Specifications (性能)

Temperature coefficient	温度系数	1Ω~10Ω: ±400PPM/°C 11Ω~10M: ±100PPM/°C
Short-time overload	短时间过负荷	±(1.0%+0.1Ω) Max (最大)
Terminal bending	端子弯曲	±(1.0%+0.05Ω) Max (最大)
Solderability	可焊性	Min 95% coverage (最少 95% 覆盖率)
Dielectric withstanding voltage	绝缘耐压	No evidence of flashover, mechanical damage, arcing or insulation breakdown 无击穿, 飞弧及可见机械性损伤
Soldering heat	耐焊接热	±(1.0%+0.05Ω) Max (最大)
Temperature cycling	温度循环	±(1.0%+0.05Ω) Max (最大)
Load Life in humidity	湿度寿命	±(3.0%+0.1Ω) Max (最大)
Load life	负载寿命	±(3.0%+0.1Ω) Max (最大)
Humidity (steady state)	恒定湿热	±(3.0%+0.1Ω) Max (最大)
Single pulse	单脉冲	±(1.0%+0.1Ω) Max (最大)

Ordering Procedure (Example: Anti-surge AS03 1/4WS 5% 10KΩ T/R-5000)

订购方式 (例如: 抗浪涌 AS03 1/4WS 5% 10KΩ T/R-5000)

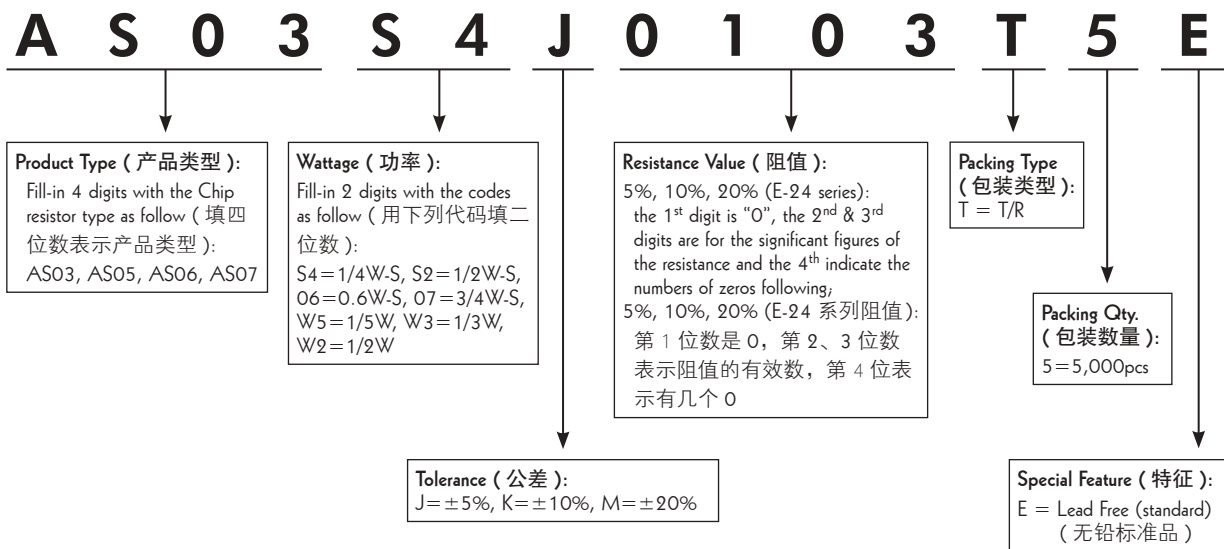

### Feature (特性)

- High-Precision, high-power, anti-pulse 高精度、高功率、抗脉冲
- Suitable for reflow & wave soldering 适合波峰焊与回流焊
- Application monitors, power supplies, DVD, camcorder, laptop computer  
适用于显示器、电源、DVD 摄像机、手提电脑

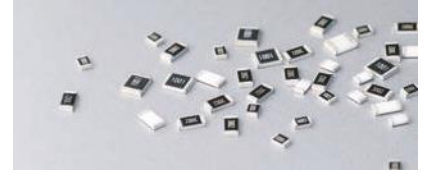

### Figures (型状)

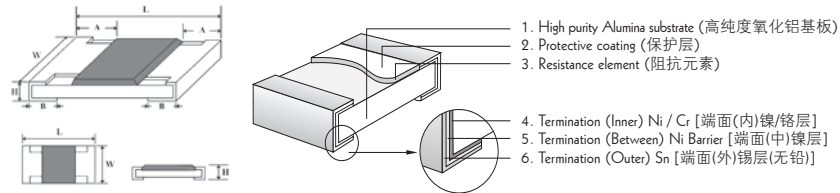

### Derating Curve (降功率曲线)

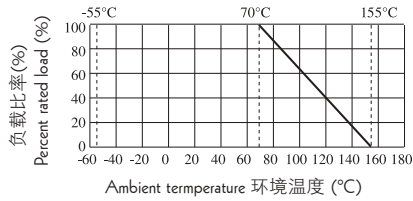

### Curve of Pulse Duration (脉冲曲线)

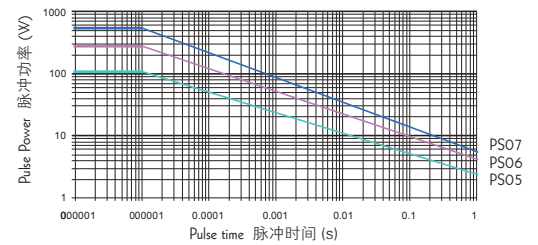

### Specification (性能)

Type 类型	Max working voltage 最大工作电压	Max Overload Voltage 最大过负荷电压	Dielectric Withstanding Voltage 绝缘耐压			Operating Temperature 工作温度范围
PS05	150V	300V	500V			-55~+155°C
PS06	200V	400V	500V			
PS07	200V	500V	500V			

Type 类型	Power 功率 (70°C)	L (mm)	W (mm)	H (mm)	A (mm)	B (mm)	Resistance Range 阻值范围 1%(E96), 5%(E24)
PS05	1/3W	2.00±0.15	1.25 <sup>+0.15</sup> <sub>-0.10</sub>	0.55±0.10	0.40±0.20	0.40±0.20	1Ω~10M
PS06	1/2W	3.10±0.15	1.55 <sup>+0.15</sup> <sub>-0.10</sub>	0.55±0.10	0.45±0.20	0.45±0.20	
PS07	3/4W-S	3.10±0.10	2.60 <sup>+0.15</sup> <sub>-0.10</sub>	0.55±0.10	0.55±0.25	0.50±0.20	

Performance Specification (性能)

Temperature coefficient	温度系数	PS05, PS06: $\leq 10\Omega: \pm 200\text{ppm}/^\circ\text{C}$ $> 10\Omega: \pm 100\text{ppm}/^\circ\text{C}$ PS07: $\pm 100\text{ppm}/^\circ\text{C}$
Short-time overload	短时间过负荷	$\pm 1\%: \pm(1.0\%+0.1\Omega)\text{Max. (最大)}$ $\pm 5\%: \pm(2.0\%+0.1\Omega)\text{Max. (最大)}$
Terminal bending	端子弯曲	$\pm(1.0\%+0.05\Omega)\text{Max. (最大)}$
Solderability	可焊性	Min. 95% Coverage (最少 95% 覆盖率)
Soldering heat	耐焊接热	$\pm(1.0\% + 0.05\Omega)\text{Max. (最大)}$
Load life in humidity	湿度寿命	$\pm 1\%: \pm(1.0\%+0.1\Omega)\text{Max. (最大)}$ $\pm 5\%: \pm(3.0\%+0.1\Omega)\text{Max. (最大)}$
Dielectric withstanding voltage	绝缘耐压	No evidence of flashover, mechanical damage, arcing or insulation breakdown 无击穿, 飞弧及可见机械性损伤
Temperature Cycling	温度循环	$\pm 1\%: \pm(0.5\%+0.1\Omega)\text{Max. (最大)}$ $\pm 5\%: \pm(3.0\%+0.1\Omega)\text{Max. (最大)}$
Load life	负载寿命	$\pm 1\%: \pm(1.0\%+0.1\Omega)\text{Max. (最大)}$ $\pm 5\%: \pm(3.0\%+0.1\Omega)\text{Max. (最大)}$
Single pulse	单脉冲	$\pm(1.0\%+0.1\Omega)\text{Max. (最大)}$

Ordering Procedure (Example: PS05 1/3W 5% 120K $\Omega$  T/R-5000)

订购方式 (例如: PS05 1/3W 5% 120K $\Omega$  T/R-5000)

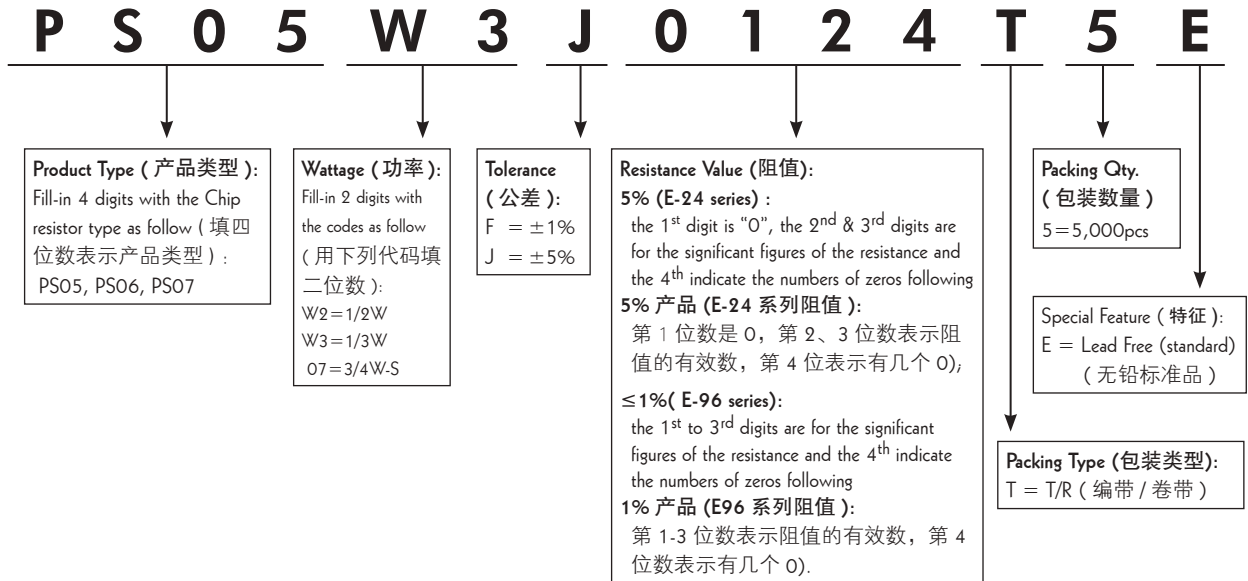

### Feature (特性)

- High power in standard size  
标准尺寸，高功率
- Suitable for both wave & re-flow soldering  
适合波峰焊与回流焊
- Application: AV adapters, LCD back-light, camera strobe etc. 适用于AV适配器, LCD 背光电路, 照相机快门等

### Figures (型状)

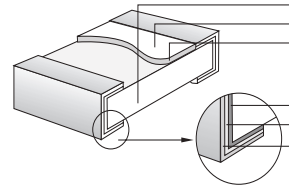
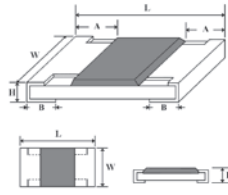

1. High purity Alumina substrate (高纯度氧化铝基板)
2. Protective coating (保护层)
3. Resistance element (阻抗元素)
4. Termination (Inner) Ni / Cr [端面(内)镍/铬层]
5. Termination (Between) Ni Barrier [端面(中)镍层]
6. Termination (Outer) Sn [端面(外)锡层(无铅)]

### Derating Curve & Specification (降功率曲线及性能)

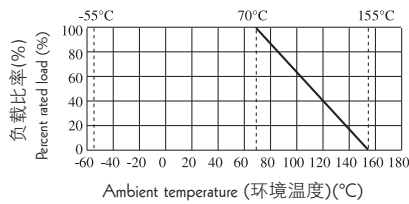

Type 类型	Max. Working Voltage 最大工作电压	Max. Overload Voltage 最大过负荷电压	Dielectric Withstanding Voltage 绝缘耐压	Operating Temperature 工作温度范围
HP02	50V	100V	100V	-55°C~155°C
HP03	50V	100V	300V	-55°C~155°C
HP05	150V	300V	500V	-55°C~155°C
HP06	200V	400V	500V	-55°C~155°C
HP07	200V	500V	500V	-55°C~155°C
HP10	200V	500V	500V	-55°C~155°C
HP12	250V	500V	500V	-55°C~155°C

Type 类型	Power Rating at 70°C 功率	L(mm)	W(mm)	H(mm)	A(mm)	B(mm)	Resistance Range of 1% 1%的阻值范围	Resistance Range of 5% 5%的阻值范围
HP02	1/10W	1.00±0.10	0.50 <sup>+0.05</sup> <sub>-0.05</sub>	0.35±0.05	0.20±0.10	0.25±0.10	1Ω~10M	1Ω~10M
HP03	1/5W	1.60±0.10	0.80 <sup>+0.15</sup> <sub>-0.10</sub>	0.45±0.10	0.30±0.20	0.30±0.20	1Ω~10M	1Ω~10M
HP05	1/3W	2.00±0.15	1.25 <sup>+0.15</sup> <sub>-0.10</sub>	0.55±0.10	0.40±0.20	0.40±0.20	1Ω~10M	1Ω~10M
HP06	1/2W	3.10±0.15	1.55 <sup>+0.15</sup> <sub>-0.10</sub>	0.55±0.10	0.45±0.20	0.45±0.20	1Ω~10M	1Ω~10M
HP07	3/4W	3.10±0.10	2.60 <sup>+0.15</sup> <sub>-0.10</sub>	0.55±0.10	0.50±0.25	0.50±0.20	1Ω~10M	1Ω~10M
HP10	1W	5.00±0.10	2.50 <sup>+0.15</sup> <sub>-0.10</sub>	0.55±0.10	0.60±0.25	0.50±0.20	1Ω~10M	1Ω~10M
HP12	2W	6.35±0.10	3.20 <sup>+0.15</sup> <sub>-0.10</sub>	0.55±0.10	0.60±0.25	1.80±0.25	1Ω~10M	1Ω~10M

### Performance Specifications (性能)

Temperature coefficient	温度系数	1Ω~10Ω ≤ ±200PPM/°C 11Ω~10MΩ ≤ ±100PPM/°C
Short-time overload	短时间过负荷	±5%: ±(2.0% + 0.1Ω) Max.(最大) ±1%: ±(1.0% + 0.1Ω) Max.(最大)
Dielectric withstanding voltage	绝缘耐压	No Evidence of flashover, mechanical damage, arcing or insulation breakdown 无击穿, 飞弧及可见机械性损伤
Terminal bending	端子弯曲	±(1.0% + 0.05Ω) Max.(最大)
Soldering heat	耐焊接热	±(1.0% + 0.05Ω) Max.(最大)
Solderability	可焊性	Min. 95% Coverage (最少 95% 覆盖率)
Temperature cycling	温度循环	±5%: ±(1.0% + 0.05Ω) Max.(最大) ±1%: ±(0.5% + 0.05Ω) Max.(最大)
Humidity (Steady state)	恒定湿热	±5%: ±(3.0% + 0.1Ω) Max.(最大) ±1%: ±(0.5% + 0.1Ω) Max.(最大)
Load life in humidity	湿度寿命	±5%: ±(3.0% + 0.1Ω) Max.(最大) ±1%: ±(1.0% + 0.1Ω) Max.(最大)
Load life	负载寿命	±5%: ±(3.0% + 0.1Ω) Max.(最大) ±1%: ±(1.0% + 0.1Ω) Max.(最大)

\* HP02 TCR: 1Ω~10Ω: ±400PPM/°C 11Ω~100Ω: ±200PPM/°C >100Ω: ±100PPM/°C

Ordering Procedure (Example: High Power HP06 1/2W 5% 120KΩ T/R-5000)

订购方式 (例如: 高功率 HP06 1/2W 5% 120KΩ T/R-5000)

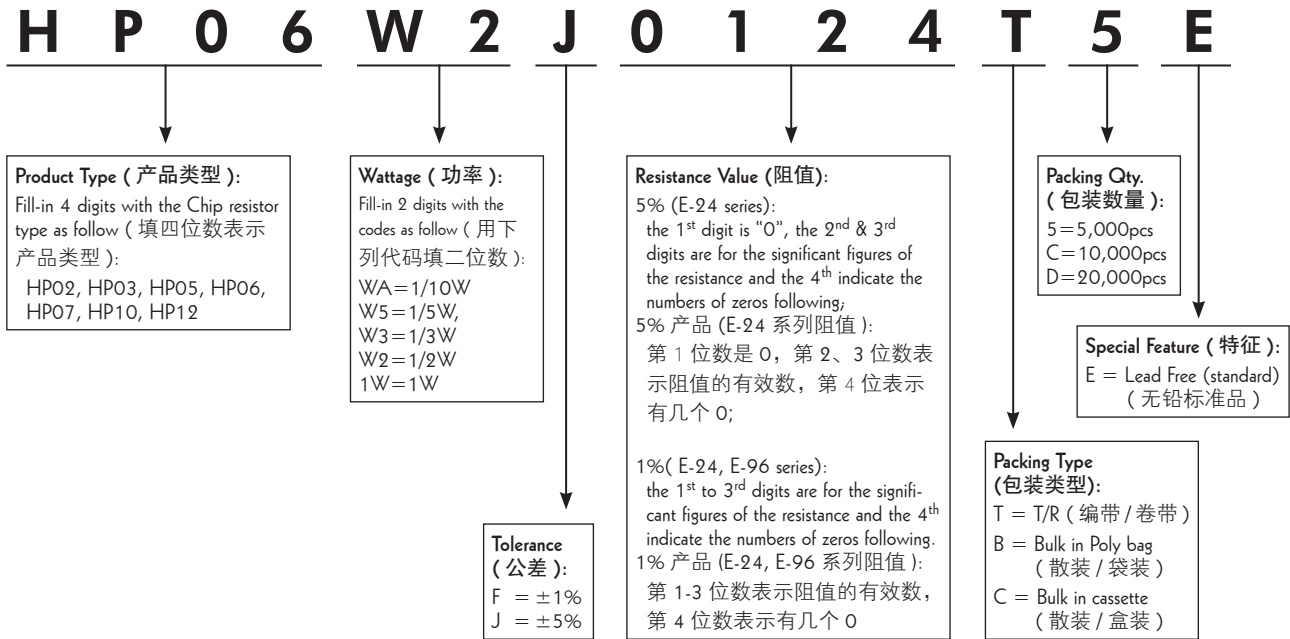

### Feature (特性)

- Low Resistance High power  
低阻值，高功率
- Suitable for reflow & wave soldering  
适合波峰焊与回流焊
- Application AV adapters, LCD back-light camera strobe etc. 适用于AV适配器, LCD背光电路, 照相机快门等

### Figures (型状)

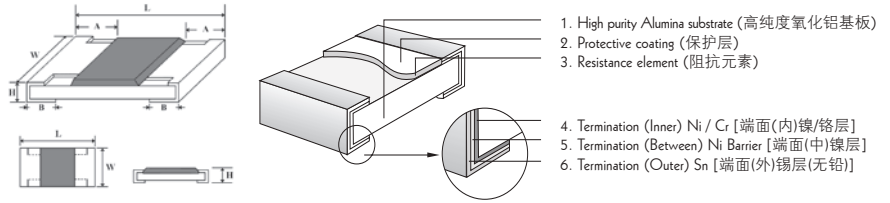

### Derating Curve & Specification (降功率曲线及性能)

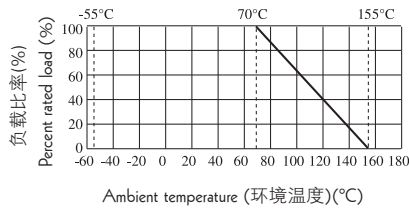

Type 类型	Max. Working Voltage 最大工作电压	Max. Overload Voltage 最大过负荷电压	Dielectric Withstanding Voltage 绝缘耐压	Operating Temperature 工作温度范围
HP03	50V	100V	300V	-55~+155°C
HP05	150V	300V	500V	
HP06	200V	400V	500V	
HP07	200V	500V	500V	
HP10	200V	500V	500V	
HP12	250V	500V	500V	

Type 类型	Power 功率 (70°C)	L (mm)	W (mm)	H (mm)	A (mm)	B (mm)	Resistance Range 阻值范围 1% & 5%
HP03	1/5W	1.60±0.10	0.80 <sup>+0.15</sup> <sub>-0.10</sub>	0.45±0.10	0.30±0.20	0.30±0.20	0.1Ω~1Ω
HP05	1/3W	2.00±0.15	1.25 <sup>+0.15</sup> <sub>-0.10</sub>	0.55±0.10	0.40±0.20	0.40±0.20	
HP06	1/2W	3.10±0.15	1.55 <sup>+0.15</sup> <sub>-0.10</sub>	0.55±0.10	0.45±0.20	0.45±0.20	
HP07	3/4W	3.10±0.10	2.60 <sup>+0.15</sup> <sub>-0.10</sub>	0.55±0.10	0.50±0.25	0.50±0.20	
HP10	1W	5.00±0.10	2.50 <sup>+0.15</sup> <sub>-0.10</sub>	0.55±0.10	0.60±0.25	0.50±0.20	
HP12	2W	6.35±0.10	3.20 <sup>+0.15</sup> <sub>-0.10</sub>	0.55±0.10	0.60±0.25	1.80±0.25	

### Performance Specification (性能)

Temperature coefficient	温度系数	HP03: ±200ppm/°C HP05: ±200ppm/°C HP06: ±100ppm/°C HP07: ±100ppm/°C HP10: ±100ppm/°C HP12: ±100ppm/°C
Short time overload	短时间过负荷	1%: ±(1.0%+0.1Ω) Max (最大) 5%: ±(2.0%+0.1Ω) Max (最大)
Terminal bending	端子弯曲	±(1.0%+0.05Ω)
Solderability	可焊性	≥95% coverage (最少 95% 覆盖率)
Dielectric withstanding voltage	绝缘耐压	No evidence of flashover, mechanical damage, arcing or insulation breakdown 无击穿, 飞弧及可见机械性损伤
Soldering heat	耐焊接热	±(1.0%+0.05Ω) Max (最大)
Temperature cycling	温度循环	1%: ±(0.5%+0.05Ω) Max (最大) 5%: ±(1.0%+0.05Ω) Max (最大)
Load Life in humidity	湿度寿命	1%: ±(1.0%+0.1Ω) Max (最大) 5%: ±(3.0%+0.1Ω) Max (最大)
Load life	负载寿命	1%: ±(1.0%+0.1Ω) Max (最大) 5%: ±(3.0%+0.1Ω) Max (最大)
Humidity (steady state)	恒定湿热	1%: ±(0.5%+0.1Ω) Max (最大) 5%: ±(3.0%+0.1Ω) Max (最大)

• HP10, HP12 T.C.R ±75ppm/°C could be provided specially (\*HP10, HP12 T.C.R ±75ppm/°C 可特别提供)

Feature (特性)

- Superior to Thick Film Chip Resistors in Max. Working Voltage 在最大工作电压上优于普通厚膜晶片电阻
- Suitable for both wave & re-flow soldering 适合波峰焊及回流焊
- Application: AV adapter, LCD Backlight, Flash Light of camera 适用于AV适配器、LCD背光电路、照相机的闪光灯等

Figures (型状)

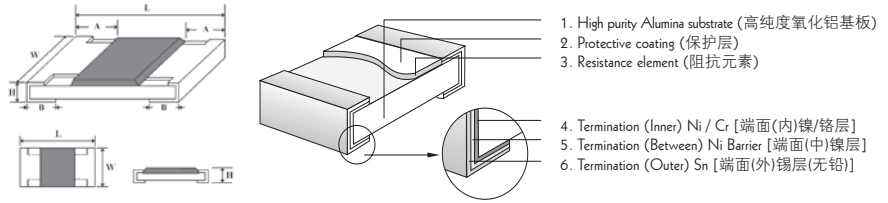

Derating Curve & Specification (降功率曲线及性能)

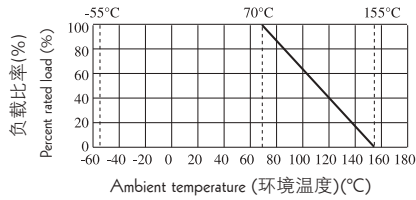

Type 类型	Max. Working Voltage 最大工作电压	Max. Overload Voltage 最大过负荷电压	Dielectric Withstanding Voltage 绝缘耐压	Operating Temperature 工作温度范围
HV03	200V	400V	300V	-55°C~155°C
HV05	400V	800V	500V	-55°C~155°C
HV06	500V	1000V	500V	-55°C~155°C
HV07	800V	1500V	500V	-55°C~155°C
HV10	2000V	3000V	500V	-55°C~155°C
HV12	3000V	4000V	500V	-55°C~155°C

Type 类型	Power Rating 功率 at 70°C	L(mm)	W(mm)	H(mm)	A(mm)	B(mm)	Resistance Range 阻值范围 1% & 5%
HV03	1/16W, 1/10W-S	1.60±0.10	0.80 <sup>+0.15</sup> <sub>-0.10</sub>	0.45±0.10	0.30±0.20	0.30±0.20	100KΩ~10MΩ
HV05	1/10W, 1/8W-S	2.00±0.15	1.25 <sup>+0.15</sup> <sub>-0.10</sub>	0.55±0.10	0.40±0.20	0.40±0.20	
HV06	1/8W, 1/4W-S	3.10±0.15	1.55 <sup>+0.15</sup> <sub>-0.10</sub>	0.55±0.10	0.45±0.20	0.45±0.20	
HV07	1/3W-S, 1/2W-SS	3.10±0.10	2.60 <sup>+0.15</sup> <sub>-0.10</sub>	0.55±0.10	0.50±0.25	0.50±0.20	50KΩ~10MΩ
HV10	1/2W, 3/4W-S	5.00±0.10	2.50 <sup>+0.15</sup> <sub>-0.10</sub>	0.55±0.10	0.60±0.25	0.50±0.20	
HV12	1W	6.35±0.10	3.20 <sup>+0.15</sup> <sub>-0.10</sub>	0.55±0.10	0.60±0.25	0.50±0.20	

The non-standard value can be offered on a case to case basis. 特殊规格可特别提供

Performance Specification (性能)

Temperature coefficient	温度系数	±200PPM/°C
Short-time overload	短时间过负荷	±(2.0%+0.1Ω) Max.(最大)
Terminal bending	端子弯曲	±(1.0%+0.05Ω) Max.(最大)
Solderability	可焊性	Min. 95% Coverage (最少 95% 覆盖率)
Temperature Cycling	温度循环	5% : ±(1.0%+0.05Ω) Max.(最大) 1% : ±(0.5%+0.05Ω) Max.(最大)
Humidity (steady State)	恒定湿热	±(3.0%+0.1Ω) Max.(最大)
Load life in humidity	湿度寿命	±(3.0%+0.1Ω) Max.(最大)
Load life	负载寿命	±(3.0%+0.1Ω) Max.(最大)
Insulation resistance	绝缘电阻	≥1,000MΩ
Dielectric withstanding voltage	绝缘耐压	No evidence of flashover, mechanical damage, arcing or insulation breakdown 无击穿, 飞弧及可见机械性损伤
Soldering heat	耐焊接热	±(1.0% + 0.05Ω) Max.(最大)



### Ordering Procedure (Example: High Voltage HV06 1/4WS 5% 120KΩ T/R-5000)

订购方式 (例如: 高压 HV06 1/4W-S 5% 120KΩ T/R-5000)

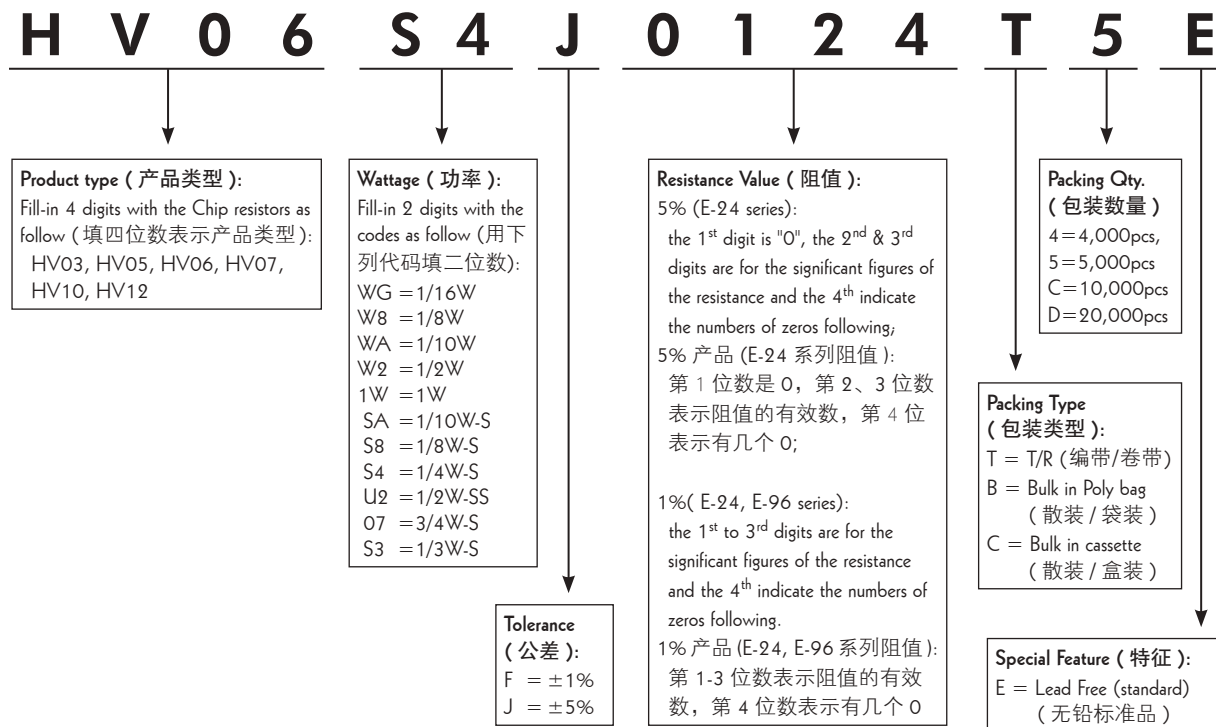

Feature (特性)

- High power & Wide terminal  
高功率，宽电极
- Suitable for both wave & re-flow soldering  
适合波峰焊及回流焊
- Application: AV adapters, LCD back-light, camera strobe etc. 适用于AV适配器, LCD背光电路, 照相机快门等

Figures (型状)

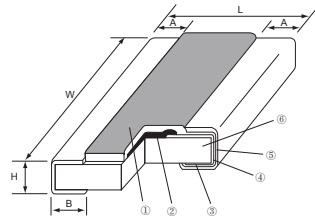

1. Protective layer (保护层)
2. Resistive element (阻抗元素)
3. Termination (Inner) Ni / Cr [端面(内)镍/铬层]
4. Termination (Between) Ni [端面(中)镍层]
5. Termination (Outer) Sn [端面(外)锡层(无铅)]
6. High purity Alumina substrate (高纯度氧化铝基板)

Derating Curve & Specification (降功率曲线及性能)

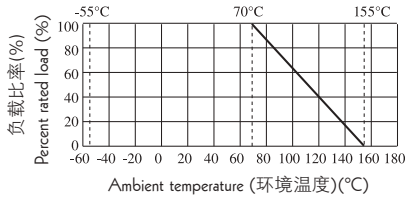

Type 类型	Max. Working Voltage 最大工作电压	Max. Overload Voltage 最大过负荷电压	Dielectric Withstanding Voltage 绝缘耐压	Operating Temperature 工作温度范围
0508	150V	300V	500V	-55°C~155°C
0612	200V	400V	500V	-55°C~155°C
1020	200V	400V	500V	-55°C~155°C
1218	200V	400V	500V	-55°C~155°C
1225	200V	400V	500V	-55°C~155°C

Type 类型	Power Rating 功率 at 70°C	L(mm)	W(mm)	H(mm)	A(mm)	B(mm)	Resistance Range 阻值范围 1%	Resistance Range 阻值范围 5%
0508	1/3W	1.20±0.10	2.00±0.10	0.55±0.10	0.20±0.10	0.30±0.20	10Ω~1M	10Ω~1M
0612	1/2W	1.60±0.15	3.20±0.15	0.55±0.10	0.30±0.20	0.45±0.20	10Ω~1M	1Ω~1M
1020	1W	2.50±0.15	5.00±0.15	0.55±0.10	0.40±0.20	0.60±0.20	10Ω~1M	1Ω~1M
1218	1W	3.10±0.10	4.60±0.15	0.55±0.10	0.45±0.20	0.40±0.20	1Ω~1M	1Ω~1M
1225	1.5W	3.10±0.15	6.25±0.15	0.55±0.10	0.45±0.20	0.65±0.20	1Ω~1M	1Ω~1M

Performance Specification (性能)

Temperature coefficient	温度系数	1Ω~10Ω ≤ ±400PPM/°C 11Ω~100Ω ≤ ±200PPM/°C >100Ω ±100PPM/°C
Short-time overload	短时间过负荷	±5%: ±(2.0% + 0.1Ω) Max. (最大) ±1%: ±(1.0% + 0.1Ω) Max. (最大)
Dielectric withstanding Voltage	绝缘耐压	No evidence of flashover, mechanical damage, arcing or insulation breakdown 无击穿, 飞弧及可见机械性损伤
Terminal bending	端子弯曲	±(1.0% + 0.05Ω) Max. (最大)
Soldering heat	耐焊接热	±(1.0% + 0.05Ω) Max. (最大)
Solderability	可焊性	Min. 95% coverage (最少 95% 覆盖率)
Temperature cycling	温度循环	±5%: ±(1.0% + 0.05Ω) Max. (最大) ±1%: ±(0.5% + 0.05Ω) Max. (最大)
Humidity (Steady State)	恒定湿热	±5%: ±(3.0% + 0.1Ω) Max. (最大) ±1%: ±(0.5% + 0.1Ω) Max. (最大)
Load life in humidity	湿度寿命	±5%: ±(3.0% + 0.1Ω) Max. (最大) ±1%: ±(1.0% + 0.1Ω) Max. (最大)
Load life	负载寿命	±5%: ±(3.0% + 0.1Ω) Max. (最大) ±1%: ±(1.0% + 0.1Ω) Max. (最大)

Ordering Procedure (Example: Wide Terminal 1218 1W 5% 120KΩ T/R-4000)

订购方式 (例如: 宽电极 1218 1W 5% 120KΩ T/R-4000)

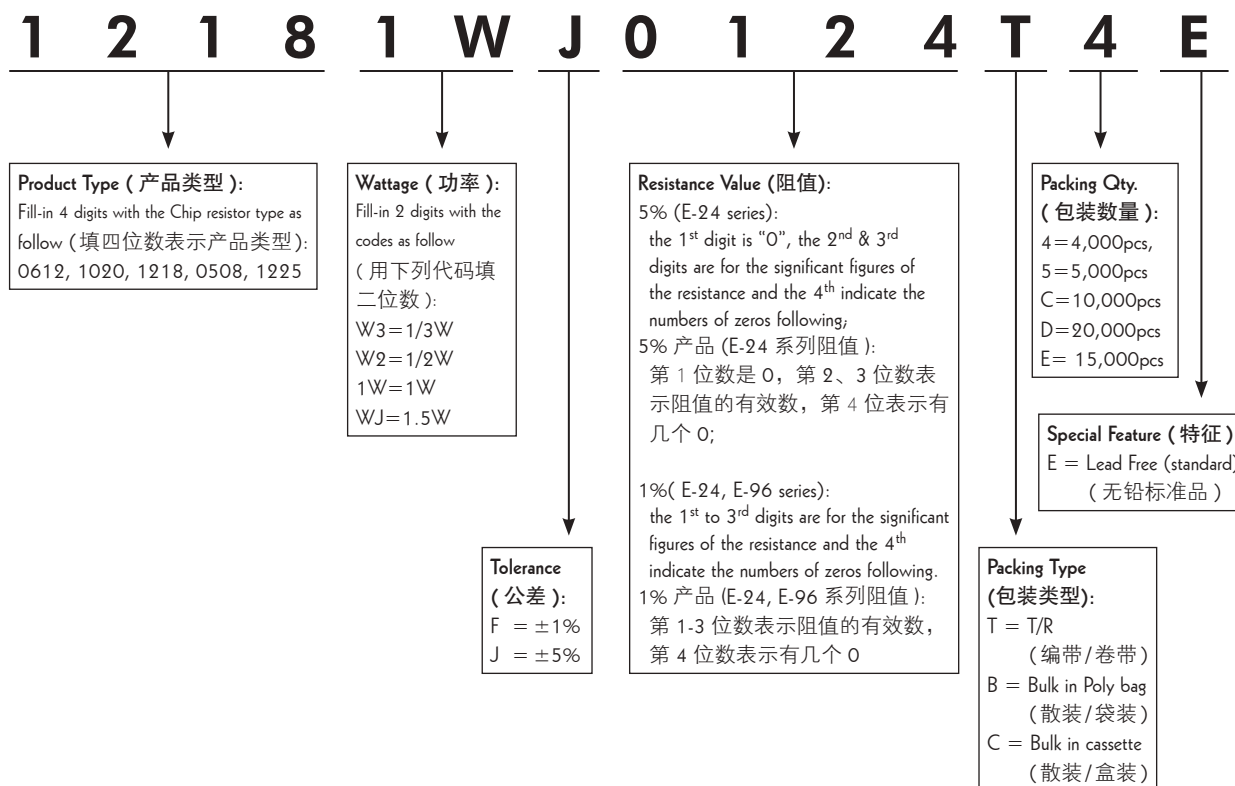

Feature (特性)

- Apply to stable circuit instead of regulating circuit to adjust the application of resistance (laser adjusting resistance machine in client end)  
适用于稳定电路中，代替调节电路来调节阻值的应用(客户端激光调阻机)
- Superior heat & humidity withstanding performance  
良好的耐高温耐湿性

Figures (形状)

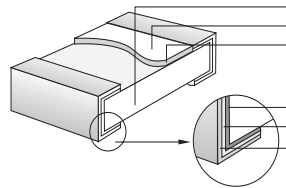
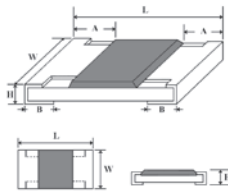

- High purity Alumina substrate 高纯度氧化铝基板
- Protective coating 保护层
- Resistance element 阻抗元素
- Termination (Inner) Ni / Cr 端面(内)镍/铬层
- Termination (Between) Ni Barrier 端面(中)镍层
- Termination (Outer) Sn 端面(外)锡层(无铅)

Derating Curve & Specification (降功率曲线及性能)

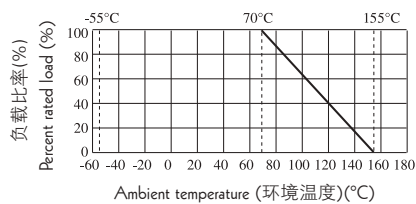

Type 类型	Max. Working Voltage 最大工作电压	Max. Overload Voltage 最大过负荷电压	Operating Temperature 工作温度范围
TR03	50V	100V	-55°C~155°C
TR05	150V	300V	-55°C~155°C
TR06	200V	400V	-55°C~155°C

Type 类型	Power Rating 功率 70°C	L(mm)	W(mm)	H(mm)	A(mm)	B(mm)	Tolerance 公差	Resistance Range 阻值范围 (E-12)
TR03	1/16W, 1/10W-S	1.60±0.10	0.80 <sup>+0.15</sup> <sub>-0.10</sub>	0.45±0.10	0.30±0.20	0.30±0.20	R: 0~30% Q: 0~20% T: 0~10% S: -10~0% N: -20~0% P: -30~0% K: ±10% M: ±20%	1Ω~1M
TR05	1/10W, 1/8W-S	2.00±0.15	1.25 <sup>+0.15</sup> <sub>-0.10</sub>	0.55±0.10	0.40±0.20	0.40±0.20		
TR06	1/8W, 1/4W-S	3.10±0.15	1.55 <sup>+0.15</sup> <sub>-0.10</sub>	0.55±0.10	0.45±0.20	0.45±0.20		

Performance Specification (性能)

Temperature coefficient 温度系数	TR03: 1Ω~10Ω: ±400PPM/°C >10Ω: ±200PPM/°C TR05, TR06: ±200PPM/°C
Short-time overload 短时间过负荷	±(2.0%+0.1Ω) Max.(最大)
Terminal bending 端子弯曲	±(1.0%+0.05Ω) Max.(最大)
Solderability 可焊性	Min. 95% coverage (最少 95% 覆盖率)
Soldering heat 耐焊接热	±(1.0%+0.05Ω) Max.(最大)
Temperature cycling 温度循环	±(1.0%+0.05Ω) Max.(最大)
Load life in humidity 湿度寿命	±(3.0%+0.1Ω) Max.(最大)
Load life 负载寿命	±(3.0%+0.1Ω) Max.(最大)

Ordering Procedure (Example: Trimmable TR06 1/4W-S  $\pm 20\%$  120K $\Omega$  T/R-5000)

订购方式 (例如: 可调 TR06 1/4W-S  $\pm 20\%$  120K $\Omega$  T/R-5000)

The values which are not of standard E-12 series could be offered on a case to case basis.

阻值如不在 E-12 系列的可特别提供。

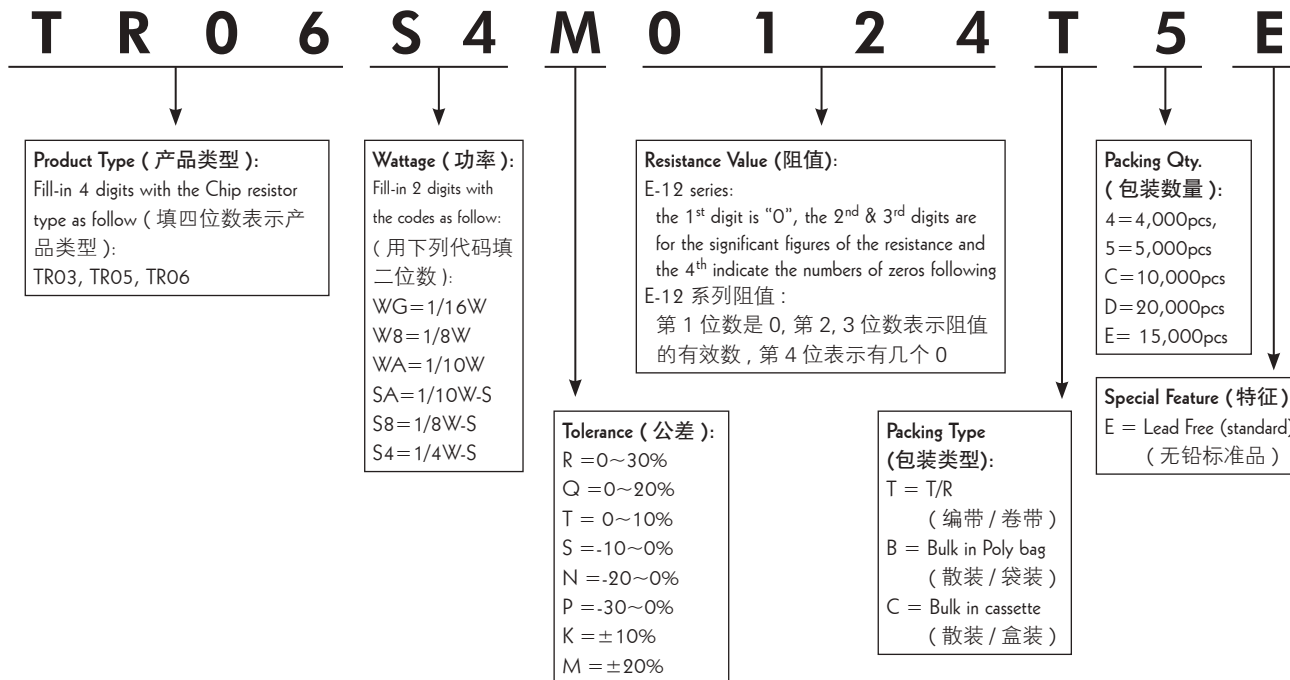

Feature (特性)

- Ultra-low Value  
超低阻值
- Low Temperature Coefficient  
低温度系数
- Suitable for reflow & wave soldering  
适合波峰焊及回流焊
- Application: Power supply  
应用于电源

Figures (型状)

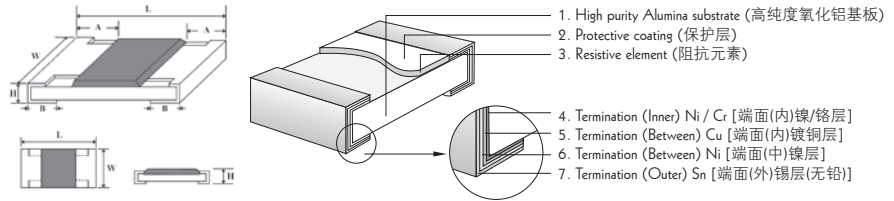

Derating Curve & Specification (降功率曲线及性能)

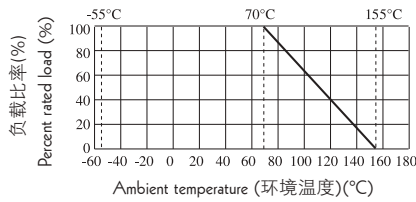

Type 类型	Dielectric Withstanding Voltage 绝缘耐压	Operating Temperature 工作温度范围
CS03	300V	-55°C~155°C
CS05	500V	-55°C~155°C
CS06	500V	-55°C~155°C
CS07	500V	-55°C~155°C
CS10	500V	-55°C~155°C
CS12	500V	-55°C~155°C

Type 类型	Power Rating 功率 70°C	L(mm)	W(mm)	H(mm)	A(mm)	B(mm)	Resistance Range 阻值范围 1% & 5%	T.C.R. 温度系数
CS03	1/10W 1/5W-S	1.60±0.10	0.80 <sup>+0.15</sup> / <sub>-0.10</sub>	0.45±0.10	0.30±0.20	0.30±0.20	33~50mΩ 50.1mΩ~0.1Ω: ≤±500ppm/°C 0.11Ω~0.5Ω: ≤±400ppm/°C 0.51Ω~1Ω: ≤±300ppm/°C	
CS05	1/8W 1/4W-S	2.00±0.15	1.25 <sup>+0.15</sup> / <sub>-0.10</sub>	0.55±0.10	0.40±0.20	0.40±0.20	20mΩ~25mΩ: ≤±600ppm/°C 25.1mΩ~0.1Ω: ≤±400ppm/°C 0.11Ω~0.5Ω: ≤±300ppm/°C 0.51Ω~1Ω: ≤±200ppm/°C	
CS06	1/4W 1/3W-S	3.10±0.15	1.55 <sup>+0.15</sup> / <sub>-0.10</sub>	0.55±0.10	0.45±0.20	0.45±0.20	20mΩ~50mΩ: ≤±400ppm/°C 50.1mΩ~0.1Ω: ≤±300ppm/°C 0.11Ω~1Ω: ≤±200ppm/°C	
CS07	1/3W 1/2W-S	3.10+/-0.10	2.60 <sup>+0.15</sup> / <sub>-0.10</sub>	0.55±0.10	0.50±0.25	0.50±0.20	20mΩ~50mΩ: ≤±400ppm/°C 50.1mΩ~1Ω: ≤±200ppm/°C	
CS10	1/2W 3/4W-S	5.00±0.10	2.50 <sup>+0.15</sup> / <sub>-0.10</sub>	0.55±0.10	0.60±0.25	0.50±0.20	10mΩ~19mΩ: ±600ppm/°C 20mΩ~50mΩ: ≤±400ppm/°C 50.1mΩ~1Ω: ≤±200ppm/°C	
CS12	1W	6.35±0.10	3.20 <sup>+0.15</sup> / <sub>-0.10</sub>	0.55±0.10	0.60±0.25	0.80±0.30	10mΩ~19mΩ: ±600ppm/°C 20mΩ~50mΩ: ≤±400ppm/°C 50.1mΩ~1Ω: ≤±200ppm/°C	

Performance Specifications (性能)

Short-time overload 短时间过负荷	1%: ±(1.0%+0.005Ω) Max. (最大) 5%: ±(2.0%+0.005Ω) Max. (最大)
Terminal bending 端子弯曲	±(1.0%+0.005Ω) Max. (最大)
Solderability 可焊性	Min. 95% coverage (最少95%覆盖率)
Dielectric withstanding Voltage 绝缘耐压	No evidence of flashover, mechanical damages, arcing or insulation breakdown 无击穿, 电弧及可见机械性损伤
Temperature cycling 温度循环	±(1.0%+0.005Ω) Max. (最大)
Soldering heat 耐焊接热	±(1.0%+0.005Ω) Max. (最大)
Load life in humidity 湿度寿命	1%: ±(1.0%+0.005Ω) Max. (最大) 5%: ±(3.0%+0.005Ω) Max. (最大)
Load life 负载寿命	1%: ±(1.0%+0.005Ω) Max. (最大) 5%: ±(3.0%+0.005Ω) Max. (最大)

\* CS07 size in 0.75W 0.1~1Ω 100PPM/°C could be provided specially (\* CS07 0.75W 0.1~1Ω 100PPM/°C 可特别提供)

\* CS12 size in 1W 50.1mΩ~0.1Ω T.C.R ±100ppm/°C could be provided specially(\* CS12 1W 50.1mΩ~0.1Ω T.C.R ±100ppm/°C 可特别提供)

Ordering Procedure (Example: CS12 1W 5% 22mΩ T/R-4000)

订购方式 (例如: CS12 1W 5% 22mΩ T/R-4000)

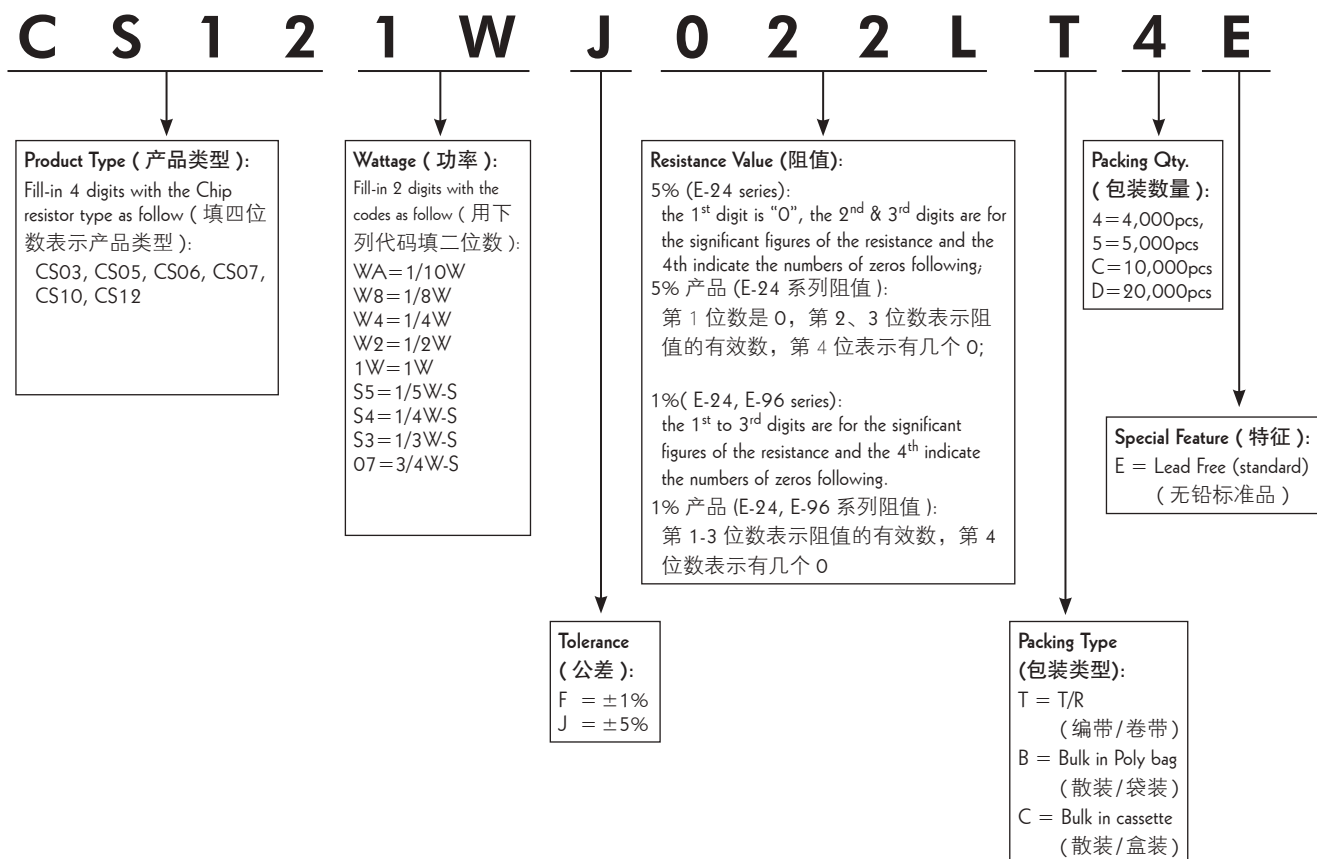

Feature (特性)

- The relevant provisions of the AEC-Q200. 符合AEC-Q200相关条款
- Suitable for reflow & wave soldering. 适合波峰焊与回流焊
- Application car. 适用于汽车

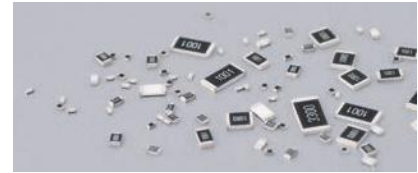

Figures (型状)

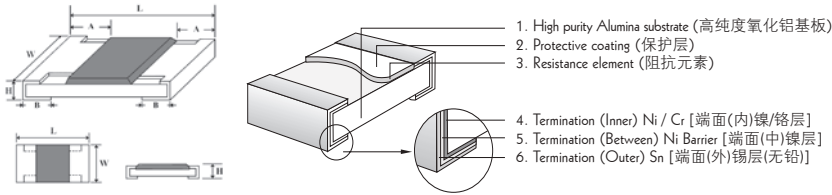

Derating Curve 降功率曲线

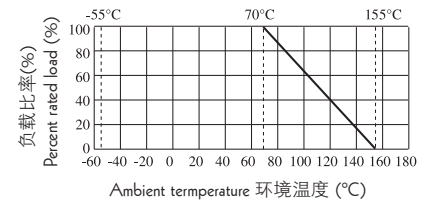

Specification (性能)

Type 类型	Max working voltage 最大工作电压	Max Overload Voltage 最大过负荷电压	Resistance Value of Jumper 零欧姆电阻阻值	Rated Current Of Jumper 零欧姆电阻 额定电流	Max. Current Of Jumper 零欧姆电阻 最大电流	Operating Temperature 工作温度范围
HQ02	50V	100V	/	/	/	-55~+155°C
HQ03	50V	100V	< 20mΩ	1A	2A	
HQ05	150V	300V	< 20mΩ	2A	5A	
HQ06	200V	400V	< 20mΩ	2A	10A	
HQ07	200V	500V	< 20mΩ	2A	10A	
HQ10	200V	500V	< 20mΩ	2A	10A	
HQ12	200V	500V	/	/	/	

Type 类型	Power 功率 (70°C)	L (mm)	W (mm)	H (mm)	A (mm)	B (mm)	Resistance Range 阻值范围 1%(E96), 5%(E24)
HQ02	1/16W	1.00±0.10	0.50±0.05	0.35±0.05	0.20±0.10	0.25±0.10	1Ω~10M
HQ03	1/16W (1/10W-S)	1.60±0.10	0.80 <sup>+0.15</sup> <sub>-0.10</sub>	0.45±0.10	0.30±0.20	0.30±0.20	
HQ05	1/10W (1/8W-S)	2.00±0.15	1.25 <sup>+0.15</sup> <sub>-0.10</sub>	0.55±0.10	0.40±0.20	0.40±0.20	
HQ06	1/8W (1/4W-S)	3.10±0.15	1.55 <sup>+0.15</sup> <sub>-0.10</sub>	0.55±0.10	0.45±0.20	0.45±0.20	
HQ07	1/4W (1/3W-S)	3.10±0.10	2.60 <sup>+0.15</sup> <sub>-0.10</sub>	0.55±0.10	0.50±0.25	0.50±0.20	
HQ10	1/2W (3/4W-S)	5.00±0.10	2.50 <sup>+0.15</sup> <sub>-0.10</sub>	0.55±0.10	0.60±0.25	0.50±0.20	
HQ12	1W	6.35±0.10	3.20 <sup>+0.15</sup> <sub>-0.10</sub>	0.55±0.10	0.60±0.25	0.50±0.20	



### Performance Specification (性能)

试验项目 Test Item	试验方法 Test Methods	判定标准 Determine Specification
温度系数 Temperature coefficient	测定范围: -55°C ~ +125°C Measure between: -55°C ~ +125°C	1Ω ≤ R ≤ 10 Ω: ≤ ±400ppm/°C 11Ω < R ≤ 100 Ω: ≤ ±200ppm/°C 100Ω < R ≤ 10MΩ: ≤ ±100ppm/°C
短时间过负荷 Short-time overload	2.5 倍额定电压或最大过负荷电压 (取其低者), 持续 5 秒钟, 然后测阻值。 2.5x Rated voltage or Max. Overload Voltage whichever is lower for 5 seconds, then check the resistance.	±1%: ±(1.0%+0.1Ω)Max (最大) ±5%: ±(2.0%+0.1Ω)Max (最大)
端子弯曲 Terminal Bending	弯曲距离 (Bending Distance): 5mm, 保持时间: 60s ± 5s, 然后测试阻值。 Duration: 60s ± 5s, then check the resistance.	±(1.0%+0.05Ω)Max (最大)
可焊性 Solderability	245 ± 3°C, 2~3 秒 245 ± 3°C, 2~3s	覆盖率 ≥ 95% 95% coverage Min
耐焊接热 Soldering heat	260 ± 5°C, 10 ± 1 秒 260 ± 5°C, 10 ± 1s	±(1.0%+0.05Ω) Max (最大)
耐湿性 Moisture Resistance	25°C~65°C, 90~100%RH, 2.5 小时; 65°C 90~100%RH, 3 小时; 65°C~25°C, 80~100%RH, 2.5 小时, 10 个循环, 试验结束 24 小时后进行测试。 25°C~65°C, 90~100%RH, 2.5H, 65°C 90~100%RH, 3H, 65°C~25°C 80~100%RH, 2.5H, 10 cycles, Measurement at 24 hours after test conclusion MIL-STD-202 Method 106	±1%: ±(0.5%+0.1Ω)Max (最大) ±5%: ±(3.0%+0.1Ω) Max (最大)
偏置湿度 Biased Humidity	10% 额定功率, 85°C/85%RH, 持续通电 1000 小时, 试验结束 24 小时后进行测试。 10% rated power, 85°C/85%RH, 1000H, Measurement at 24 hours after test conclusion MIL-STD-202 Method 103	±1%: ±(1.0%+0.1Ω)Max (最大) ±5%: ±(3.0%+0.1Ω) Max (最大)
绝缘耐压 Dielectric withstanding voltage	电阻固定在 90°C 的 V 型槽中, 根据不同产品规定交流电压, 持续 60~70 秒。 Resistor shall be clamped in the trough of 90°C metallic V-block and shall be tested at AC potential respectively specified in the given list of each product type for 60~70s.	无击穿, 飞弧及可见机械性损伤 No evidence of flashover, mechanical damage, arcing or insulation breakdown
温度循环 Temperature cycling	-55 ± 3°C (30 分钟) ~ 室温 (10-15 分钟) ~ 155 ± 2°C (30 分钟) ~ 室温 (10~15 分钟) 1000 个循环, 试验结束 24 小时后进行测试。 -55 ± 3°C 30min ~ normal temperature 10min-15min ~ 155 ± 2°C 30min ~ normal temperature 10min-15min 1000 cycles, Measurement at 24 hours after test conclusion. JESD22 Method JA-104	±1%: ±(0.5%+0.1Ω) Max (最大) ±5%: ±(1.0%+0.1Ω) Max (最大)
负载寿命 Load life	125°C, 额定功率, 试验结束 24 小时后进行测试。 125°C, at rated power, Measurement at 24 ± 2 hours after test conclusion. MIL-STD-202 Method 108	±1%: ±(1.0%+0.1Ω) Max (最大) ±5%: ±(3.0%+0.1Ω) Max (最大)

### Ordering Procedure (Example: HQ06 1/4W-S 5% 1.2 Ω T/R-5000)

订购方式 (例如: HQ06 1/4W-S 5% 1.2 Ω T/R-5000)

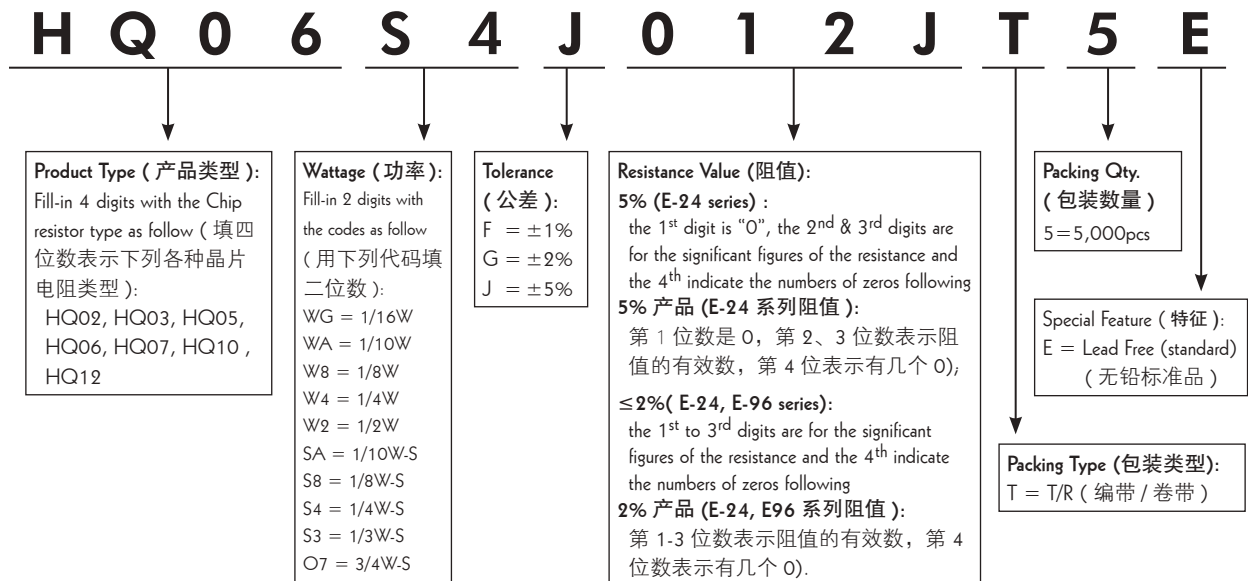

Feature (特性)

- Non-magnetic 无磁性
- Suitable for reflow & wave soldering 适合波峰焊与回流焊
- Application Mobile Phone, PDA, Setbox, Meter 适用于移动电话、PDA、机顶盒、仪表



Figures (型状)

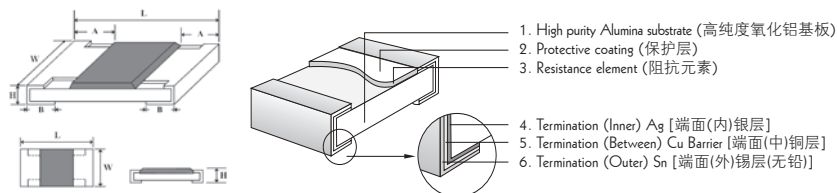

Derating Curve (降功率曲线)

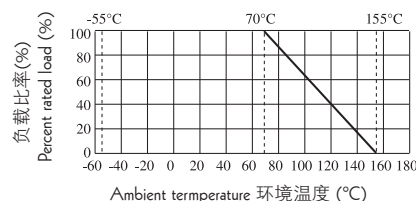

Specification (性能)

Type 类型	Max working voltage 最大工作电压	Max Overload Voltage 最大过负荷电压	Operating Temperature 工作温度范围
NM02	50V	100V	-55~+155°C
NM03	50V	100V	
NM05	150V	300V	

Type 类型	Power 功率 (70°C)	L (mm)	W (mm)	H (mm)	A (mm)	B (mm)	Resistance Range 阻值范围 1%(E96), 5%(E24)
NM02	1/16W	1.00±0.10	0.50±0.05	0.35±0.05	0.20±0.20	0.25±0.10	1Ω~10M
NM03	1/16W (1/10W-S)	1.60±0.10	0.80 <sup>+0.15</sup> <sub>-0.10</sub>	0.45±0.10	0.30±0.20	0.30±0.20	
NM05	1/10W (1/8W-S)	2.00±0.15	1.25 <sup>+0.15</sup> <sub>-0.10</sub>	0.55±0.10	0.40±0.20	0.40±0.20	

Performance Specification (性能)

Temperature coefficient	温度系数	1Ω~10 Ω: ≤±400ppm/°C 11Ω~100 Ω: ≤±200ppm/°C >100Ω: ±100ppm/°C
Short-time overload	短时间过负荷	±1%: ±(1.0%+0.1Ω)Max. (最大) ±5%: ±(2.0%+0.1Ω)Max. (最大)
Terminal bending	端子弯曲	±(1.0%+0.05Ω)Max. (最大)
Solderability	可焊性	Min. 95% Coverage (最少 95% 覆盖率)
Soldering heat	耐焊接热	±(1.0%+0.05Ω) Max. (最大)
Humidity (Stead State)	恒定湿热	±1%: ±(0.5%+0.1Ω)Max. (最大) ±5%: ±(3.0%+0.1Ω) Max. (最大)
Dielectric withstanding voltage	绝缘耐压	No evidence of flashover, mechanical damage, arcing or insulation breakdown 无击穿, 飞弧及可见机械性损伤
Temperature Cycling	温度循环	±1%: ±(0.5%+0.05Ω) Max.(最大) ±5%: ±(1.0%+0.05Ω) Max.(最大)
Load life	负载寿命	±1%: ±(1.0%+0.1Ω) Max.(最大) ±5%: ±(3.0%+0.1Ω) Max.(最大)

### Ordering Procedure (Example: NM02 1/16W 5% 1.2 Ω T/R-10000)

订购方式 (例如: NM02 1/16W 5% 1.2 Ω T/R-10000)

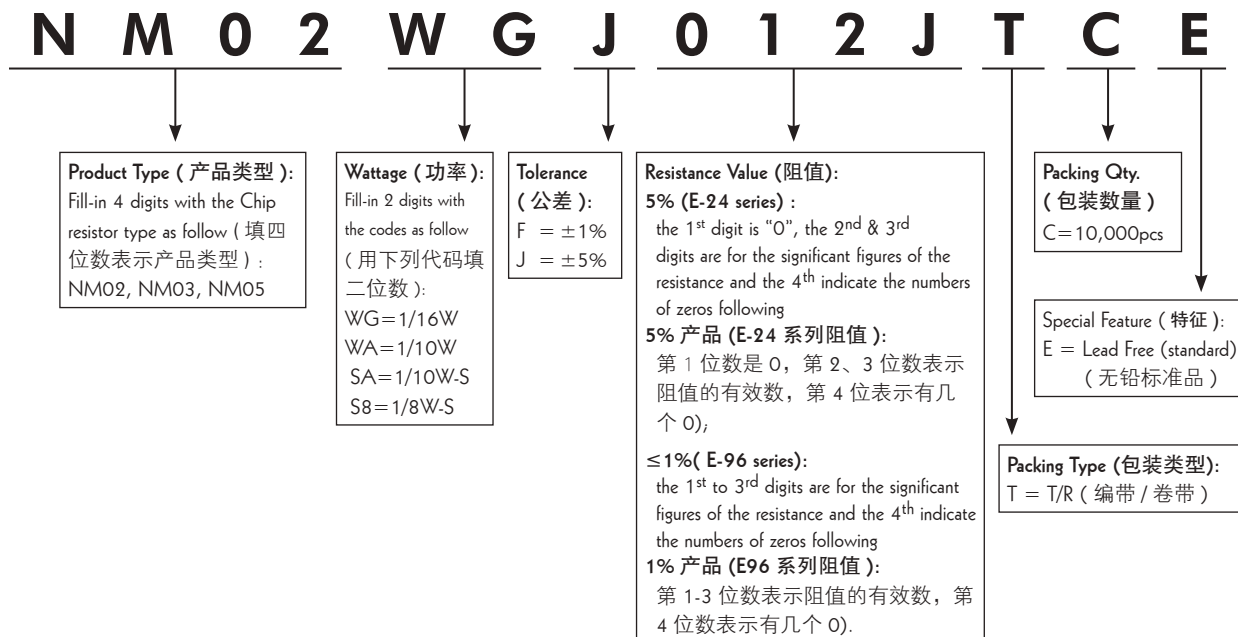

Feature (特性)

- Anti-Sulfidation (抗硫化)
- Suitable for reflow & wave soldering (适合波峰焊与回流焊)
- Application car, power (适用于汽车、电源等)

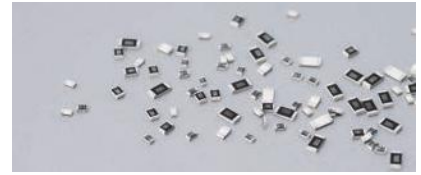

Figures (型状)

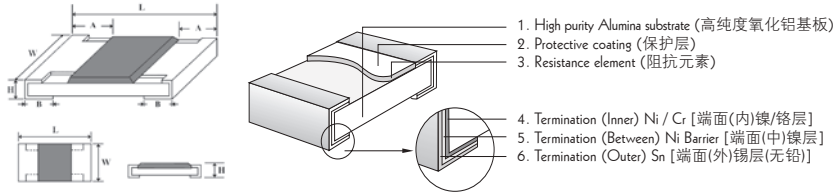

Derating Curve (降功率曲线)

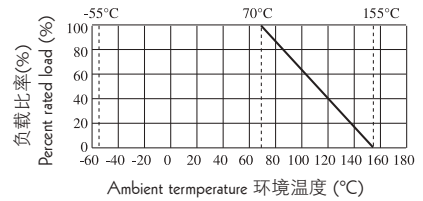

Specification (性能)

Type 类型	Max working voltage 最大工作电压	Max Overload Voltage 最大过负荷电压	Dielectric Withstanding Voltage 绝缘耐压	Resistance Value of Jumper 零欧姆电阻阻值	Rated Current Of Jumper 零欧姆电阻额定电流	Max. Current Of Jumper 零欧姆电阻最大电流	Operating Temperature 工作温度范围
NS03	50V	100V	300V	< 50mΩ	1A	2A	-55~+155°C
NS05	150V	300V	500V	< 50mΩ	1A	5A	
NS06	200V	400V	500V	< 50mΩ	2A	10A	

Type 类型	Power 功率 (70°C)	L (mm)	W (mm)	H (mm)	A (mm)	B (mm)	Resistance Range 阻值范围 1%(E96), 5%(E24)
NS03	1/16W (1/10W-S)	1.60±0.10	0.80 <sup>+0.15</sup> <sub>-0.10</sub>	0.45±0.10	0.30±0.20	0.30±0.20	1%, 5%: 1Ω~10M 0Ω
NS05	1/10W (1/8W-S)	2.00±0.15	1.25 <sup>+0.15</sup> <sub>-0.10</sub>	0.55±0.10	0.40±0.20	0.40±0.20	
NS06	1/8W (1/4W-S)	3.10±0.15	1.55 <sup>+0.15</sup> <sub>-0.10</sub>	0.55±0.10	0.45±0.20	0.45±0.20	

Performance Specification (性能)

Temperature coefficient 温度系数	1Ω~10Ω: ≤±400ppm/°C 11Ω~100Ω: ≤±200ppm/°C >100Ω: ±100ppm/°C
Short-time overload 短时间过负荷	±1%: ±(1.0%+0.1Ω)Max. (最大) ±5%: ±(2.0%+0.1Ω)Max. (最大)
Terminal bending 端子弯曲	±(1.0%+0.05Ω)Max. (最大)
Solderability 可焊性	Min. 95% Coverage (最少 95% 覆盖率)
Soldering heat 耐焊接热	±(1.0%+0.05Ω) Max. (最大)
Humidity (Stead State) 恒定湿热	±1%: ±(0.5%+0.1Ω)Max. (最大) ±5%: ±(3.0%+0.1Ω) Max. (最大)
Dielectric withstanding voltage 绝缘耐压	No evidence of flashover, mechanical damage, arcing or insulation breakdown 无击穿, 飞弧及可见机械性损伤
Temperature Cycling 温度循环	±1%: ±(0.5%+0.05Ω) Max. (最大) ±5%: ±(1.0%+0.05Ω) Max. (最大)
Load life 负载寿命	±1%: ±(1.0%+0.1Ω) Max. (最大) ±5%: ±(3.0%+0.1Ω) Max. (最大)
Sulfuration test 耐硫化性	H <sub>2</sub> S 1000ppm, 25°C, 90%Rh, 720h ±(0.5%+0.05Ω) Max. (最大)

### Ordering Procedure (Example: NS06 1/8W 5% 1.2 Ω T/R-5000)

订购方式 (例如: NS06 1/8W 5% 1.2 Ω T/R-5000)

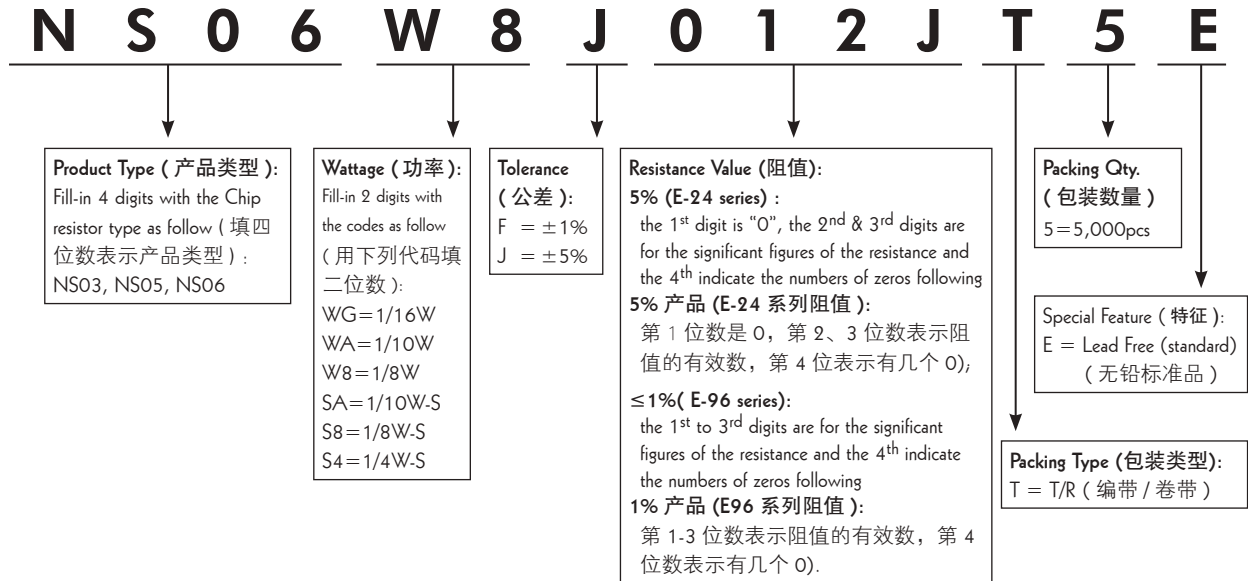

Feature (特性)

- Suitable for reflow & wave soldering (适合波峰焊与回流焊)
- Application Soft Circuit board (适用于软性电路板)

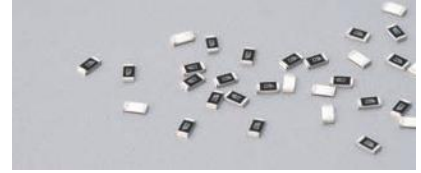

Figures (型状)

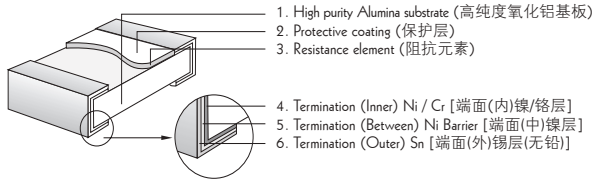
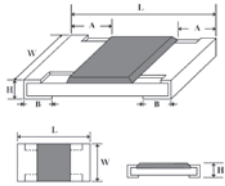

Derating Curve (降功率曲线)

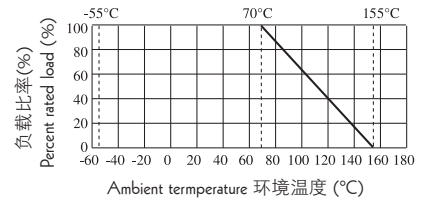

Specification (性能)

Type 类型	Max working voltage 最大工作电压	Max Overload Voltage 最大过负荷电压	Dielectric Withstanding Voltage 绝缘耐压	Operating Temperature 工作温度范围
LE06	200V	400V	500V	-55~+155°C

Type 类型	Power 功率 (70°C)	L (mm)	W (mm)	H (mm)	A (mm)	B (mm)	Resistance Range 阻值范围 1%(E96), 5%(E24)
LE06	1/8W (1/4W-S)	3.10±0.15	1.55 <sup>+0.15</sup> <sub>-0.10</sub>	0.55±0.10	0.45±0.20	0.45±0.20	0.5%, 1%, 2%, 5%: 1Ω~10M 0Ω

Performance Specification (性能)

Temperature coefficient	温度系数	1Ω~10Ω: ≤±400ppm / °C 11Ω~100Ω: ≤±200ppm / °C >100Ω: ±100ppm / °C
Short-time overload	短时间过负荷	±5%, ±2%: ±(2.0%+0.1Ω)Max. (最大) ±1%, ±0.5%: ±(1.0%+0.1Ω)Max. (最大)
Terminal bending	端子弯曲	±(1.0%+0.05Ω)Max. (最大)
Solderability	可焊性	Min. 95% Coverage (最少 95% 覆盖率)
Soldering heat	耐焊接热	±(1.0%+0.05Ω) Max. (最大)
Humidity (Stead State)	恒定湿热	±5%, ±2%: ±(3.0%+0.1Ω)Max. (最大) ±1%, ±0.5%: ±(0.5%+0.1Ω)Max. (最大)
Dielectric withstanding voltage	绝缘耐压	No evidence of flashover, mechanical damage, arcing or insulation breakdown 无击穿, 飞弧及可见机械性损伤
Temperature Cycling	温度循环	±5%, ±2%: ±(1.0%+0.05Ω)Max. (最大) ±1%, ±0.5%: ±(0.5%+0.05Ω)Max. (最大)
Load life	负载寿命	±5%, ±2%: ±(3.0%+0.1Ω)Max. (最大) ±1%, ±0.5%: ±(1.0%+0.1Ω)Max. (最大)

### Ordering Procedure (Example: LE06 1/4W-S 5% 1.2 Ω T/R-5000)

订购方式 (例如: LE06 1/4W-S 5% 1.2 Ω T/R-5000)

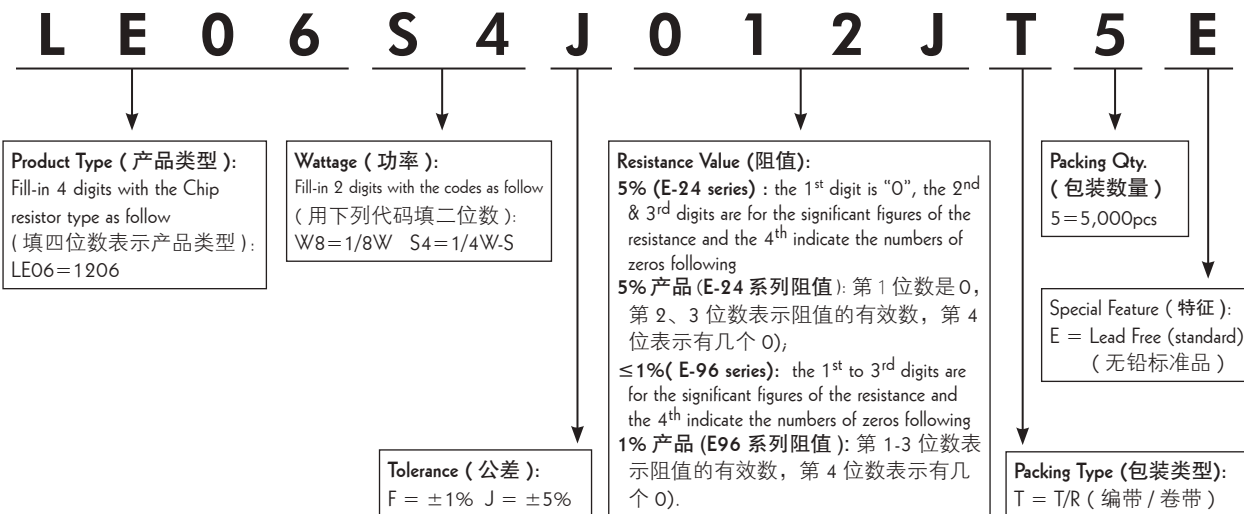

Feature (特性)

- Thin film NiCr Resistance element 薄膜镍铬阻抗元件
- Very tight tolerance from 精密的公差从  $\pm 0.10\%$ ,  $\pm 0.25\%$
- Extremely low TCR from 极低的TCR从  $\pm 5 \sim \pm 50 \text{ PPM}/^\circ\text{C}$
- Totally Lead-free 完全无铅产品

Application (应用)

- Medical Equipment 医疗器材
- Testing / Measurement Equipment 检测仪器
- Communication Device, Cell Phone, GPS, PDA. 通讯用具, 手机, GPS, PDA
- Automatic equipment controller 自动化设备控制器
- Printer Equipment 打印器材
- Converters 变频器

Figures (型状)

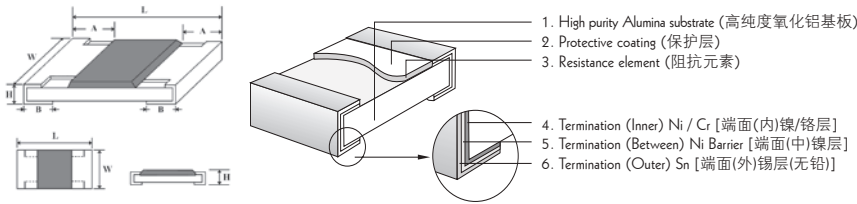

Derating Curve (降功率曲线)

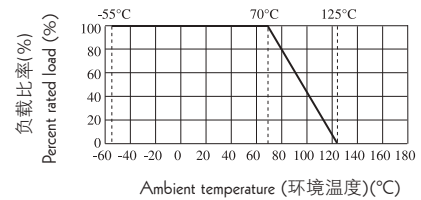

Type 类型	L (mm)	W (mm)	H (mm)	A (mm)	B (mm)
TC02	1.00±0.10	0.50 ±0.05	0.35±0.05	0.20±0.10	0.25±0.10
TC03	1.60±0.10	0.80 <sup>+0.15</sup> / <sub>-0.10</sub>	0.45±0.10	0.30±0.20	0.30±0.20
TC05	2.00±0.15	1.25 <sup>+0.15</sup> / <sub>-0.10</sub>	0.55±0.10	0.40±0.20	0.40±0.20
TC06	3.10±0.15	1.55 <sup>+0.15</sup> / <sub>-0.10</sub>	0.55±0.10	0.45±0.20	0.45±0.20
TC07	3.10±0.10	2.60 <sup>+0.15</sup> / <sub>-0.10</sub>	0.55±0.10	0.45±0.20	0.45±0.20
TC10	5.00±0.10	2.50 <sup>+0.15</sup> / <sub>-0.10</sub>	0.55±0.10	0.60±0.25	0.50±0.20
TC12	6.35±0.10	3.20 <sup>+0.15</sup> / <sub>-0.10</sub>	0.55±0.10	0.60±0.25	0.50±0.20

Ordering Procedure (Example: Thin Film TC06 1/8W 0.1% 25PPM 1KΩ T/R-5000)

订购方式(例如: 薄膜TC06 1/8W 0.1% 25PPM 1KΩ T/R-5000)

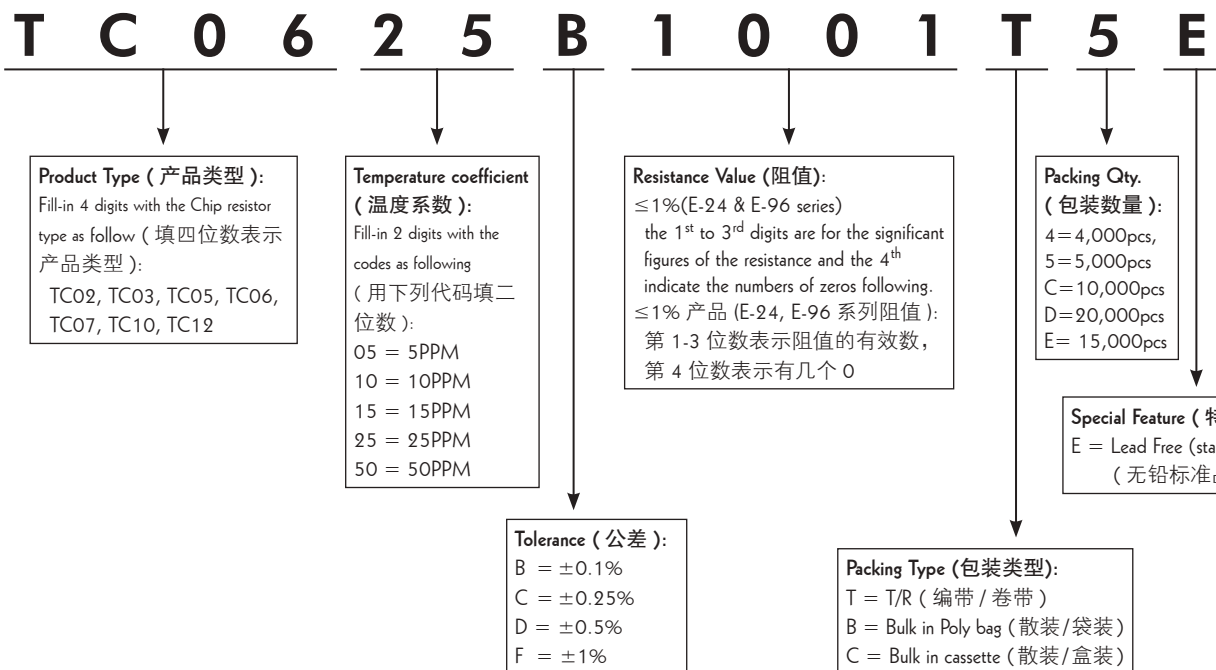



### Performance Specification (性能)

Short-time overload	短时间过负荷	$\Delta R \leq \pm 0.5\%$
Insulation Resistance	绝缘电阻	$\geq 1000M\Omega$
Load life	负载寿命	$\Delta R \leq \pm 0.2\%$ > 7K $\Omega$ $\Delta R \leq \pm 0.5\%$
Humidity (Steady State)	恒定湿热	$\Delta R \leq \pm 0.3\%$
Terminal bending	端子弯曲	$\Delta R \leq \pm 0.2\%$
Solderability	可焊性	Min 95% coverage (最少 95% 覆盖率)
Soldering heat	耐焊接热	$\Delta R \leq \pm 0.2\%$

### Characteristics (特性)

Type 类型	Power Rating 功率 at 70°C	Operating Temperature 工作温度范围	Max. Working Voltage 最大工作电压	Max. Overload Voltage 最大过负荷电压	Resistance Tolerance 阻值公差	Resistance Range 阻值范围	TCR 温度系数 (PPM/°C)
TC02	1/16W	-55~+125°C	25V	50V	$\pm 0.10\%$ $\pm 0.25\%$ $\pm 0.5\%$ $\pm 1\%$	100 $\Omega$ ~ 2K $\Omega$	$\pm 5\text{ppm}$
						50 $\Omega$ ~ 12K $\Omega$	$\pm 10\text{ppm}$
						10 $\Omega$ ~ 332K $\Omega$	$\pm 25\text{ppm}$
						10 $\Omega$ ~ 332K $\Omega$	$\pm 50\text{ppm}$
TC03	1/16W	-55~+125°C	50V	100V	$\pm 0.10\%$ $\pm 0.25\%$ $\pm 0.5\%$ $\pm 1\%$	100 $\Omega$ ~ 4K $\Omega$	$\pm 5\text{ppm}$
						50 $\Omega$ ~ 50K $\Omega$	$\pm 10\text{ppm}$
						10 $\Omega$ ~ 1M $\Omega$	$\pm 25\text{ppm}$
						10 $\Omega$ ~ 1M $\Omega$	$\pm 50\text{ppm}$
TC05	1/10W	-55~+125°C	100V	200V	$\pm 0.10\%$ $\pm 0.25\%$ $\pm 0.5\%$ $\pm 1\%$	100 $\Omega$ ~ 10K $\Omega$	$\pm 5\text{ppm}$
						50 $\Omega$ ~ 100K $\Omega$	$\pm 10\text{ppm}$
						4.7 $\Omega$ ~ 1M $\Omega$	$\pm 25\text{ppm}$
						4.7 $\Omega$ ~ 1M $\Omega$	$\pm 50\text{ppm}$
TC06	1/8W	-55~+125°C	150V	300V	$\pm 0.10\%$ $\pm 0.25\%$ $\pm 0.5\%$ $\pm 1\%$	100 $\Omega$ ~ 15K $\Omega$	$\pm 5\text{ppm}$
						50 $\Omega$ ~ 200K $\Omega$	$\pm 10\text{ppm}$
						4.7 $\Omega$ ~ 1M $\Omega$	$\pm 25\text{ppm}$
						4.7 $\Omega$ ~ 1M $\Omega$	$\pm 50\text{ppm}$
TC07	1/5W	-55~+125°C	150V	300V	$\pm 0.10\%$ $\pm 0.25\%$ $\pm 0.5\%$ $\pm 1\%$	100 $\Omega$ ~ 25K $\Omega$	$\pm 5\text{ppm}$
						50 $\Omega$ ~ 200K $\Omega$	$\pm 10\text{ppm}$
						4.7 $\Omega$ ~ 1M $\Omega$	$\pm 25\text{ppm}$
						4.7 $\Omega$ ~ 1M $\Omega$	$\pm 50\text{ppm}$
TC10	1/4W	-55~+125°C	150V	300V	$\pm 0.10\%$ $\pm 0.25\%$ $\pm 0.5\%$ $\pm 1\%$	100 $\Omega$ ~ 25K $\Omega$	$\pm 5\text{ppm}$
						50 $\Omega$ ~ 200K $\Omega$	$\pm 10\text{ppm}$
						4.7 $\Omega$ ~ 1M $\Omega$	$\pm 25\text{ppm}$
						4.7 $\Omega$ ~ 1M $\Omega$	$\pm 50\text{ppm}$
TC12	1/2W	-55~+125°C	150V	300V	$\pm 0.10\%$ $\pm 0.25\%$ $\pm 0.5\%$ $\pm 1\%$	100 $\Omega$ ~ 25K $\Omega$	$\pm 5\text{ppm}$
						50 $\Omega$ ~ 200K $\Omega$	$\pm 10\text{ppm}$
						4.7 $\Omega$ ~ 1M $\Omega$	$\pm 25\text{ppm}$
						4.7 $\Omega$ ~ 1M $\Omega$	$\pm 50\text{ppm}$

Feature (特性)

- Thin film Ni/Cr Resistance element 薄膜镍铬阻抗元件
- High power & Low noise 高功率, 低噪声
- Extremely low TCR from (低温度系数)  $\pm 25\text{PPM}/^\circ\text{C}$ ,  $\pm 50\text{PPM}/^\circ\text{C}$
- Totally Lead-free 完全无铅产品

Application (应用)

- Control circuit V.C.R V.C.R 控制电路
- Air-conditioner 空调器
- Computer, color TV 电脑, 电视
- Facsimile 传真机



Figures (型状)

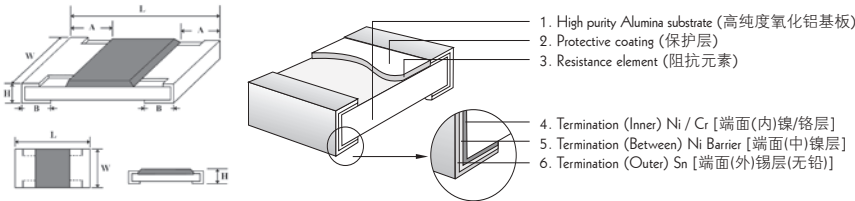

Derating Curve (降功率曲线)

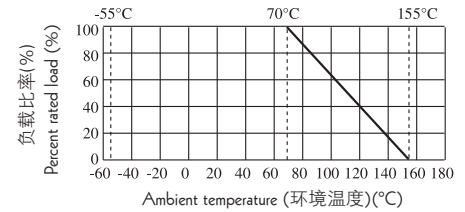

Type 类型	L (mm)	W (mm)	H (mm)	A (mm)	B (mm)
TP03	1.60±0.10	0.80 <sup>+0.15</sup> / <sub>-0.10</sub>	0.45±0.10	0.30±0.20	0.30±0.20
TP05	2.00±0.15	1.25 <sup>+0.15</sup> / <sub>-0.10</sub>	0.55±0.10	0.40±0.20	0.40±0.20
TP06	3.10±0.15	1.55 <sup>+0.15</sup> / <sub>-0.10</sub>	0.55±0.10	0.45±0.20	0.45±0.20

Characteristics (特性)

Type 类型	Power Rating 功率 at 70°C	Max. Working Voltage 最大工作电压	Max. Overload Voltage 最大过负荷电压	Resistance Range 阻值范围	Tolerance 公差	Operating Temperature 工作温度范围	T.C.R 温度系数 (PPM/°C)
TP03	1/10W, 1/6W-S	75V	150V	10Ω~1MΩ	±0.1%	-55°C~+155°C	±25PPM/°C
TP05	1/8W, 1/4W-S	150V	300V	10Ω~1MΩ	±0.25%		
TP06	1/4W, 1/3W-S	200V	400V	10Ω~1MΩ	±0.5% ±1%		

Performance Specification (性能)

Short-time overload 短时间过负荷	$\Delta R \leq \pm 0.5\%$	Humidity (Steady State) 恒定湿热	$\Delta R \leq \pm 0.3\%$
Insulation Resistance 绝缘电阻	$\geq 1,000\text{M}\Omega$	Terminal bending 端子弯曲	$\Delta R \leq \pm 0.2\%$
Load life 负载寿命	$\Delta R \leq \pm 0.2\%$	Solderability 可焊性	Min 95% coverage (最少 95% 覆盖率)
	$> 7\text{K}\Omega \Delta R \leq \pm 0.5\%$	Soldering heat 耐焊接热	$\Delta R \leq \pm 0.2\%$

Ordering Procedure (Example: High Power Thin Film TP06 1/4W 0.1% 25PPM 1KΩ T/R-5000)

订购方式 (例如: 高功率薄膜 TP06 1/4W 0.1% 25PPM 1KΩ T/R-5000)

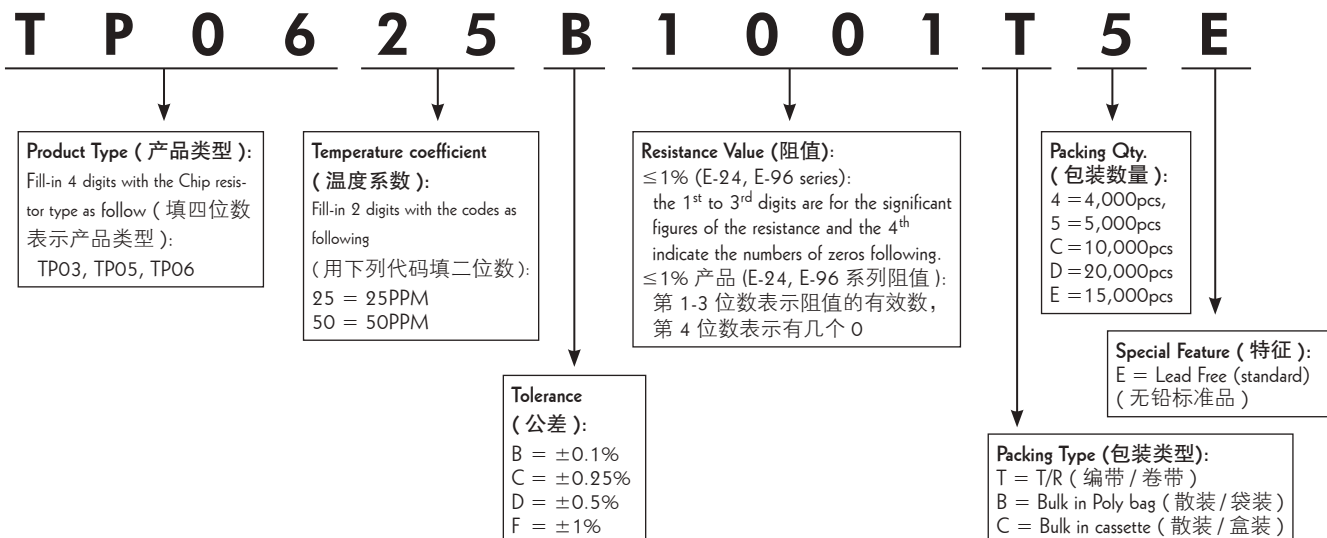

### Feature (特性)

- Thin film Ni/Cr Resistance element  
薄膜镍铬阻抗元件
- Extremely low TCR from (低温度系数)  
±50PPM/°C
- Totally Lead-free 完全无铅产品
- Low noise 低噪声

### Application (应用)

- Control circuit V.C.R V.C.R 控制电路
- Air-conditioner 空调器
- Computer, color TV 电脑, 电视
- Facsimile 传真机

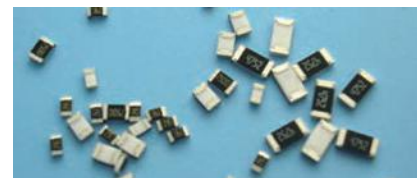

### Figures (型状)

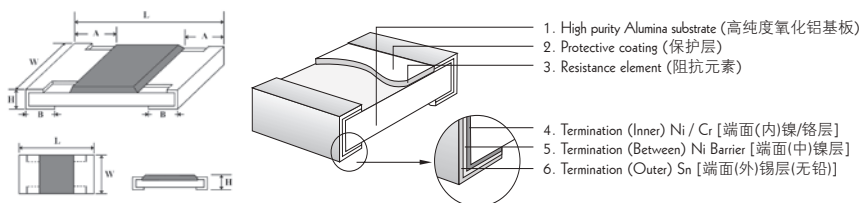

### Derating Curve (降功率曲线)

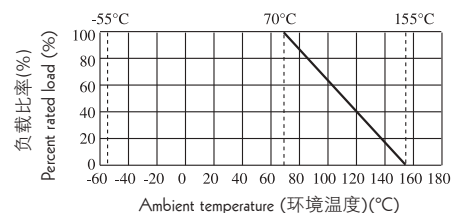

Type 类型	L (mm)	W (mm)	H (mm)	A (mm)	B (mm)
TC02	1.00±0.10	0.50 ±0.05	0.35±0.10	0.20±0.10	0.25±0.10
TC03	1.60±0.10	0.80 <sup>+0.15</sup> <sub>-0.10</sub>	0.45±0.10	0.30±0.20	0.30±0.20
TC05	2.00±0.15	1.25 <sup>+0.15</sup> <sub>-0.10</sub>	0.55±0.10	0.40±0.20	0.40±0.20
TC06	3.10±0.15	1.55 <sup>+0.15</sup> <sub>-0.10</sub>	0.55±0.10	0.45±0.20	0.45±0.20

### Characteristics (特性)

Type 类型	Power Rating 功率 at 70°C	Max. Working Voltage 最大工作电压	Max. Overload Voltage 最大过负荷电压	Resistance Range 阻值范围	Tolerance 公差	Operating Temperature 工作温度范围	T.C.R 温度系数 (PPM/°C)
TC02	1/16W	50V	100V	10Ω~10K	±5%	-55°C~+155°C	±50PPM/°C
TC03	1/16W, 1/10W-S	50V	100V				
TC05	1/10W, 1/8W-S	150V	300V				
TC06	1/8W, 1/4W-S	200V	400V				

### Performance Specification (性能)

Short-time overload 短时间过负荷	ΔR ≤ ±2%	Terminal bending 端子弯曲	ΔR ≤ ±1%
Insulation Resistance 绝缘电阻	≥ 1,000MΩ	Solderability 可焊性	Min 95% coverage (最少 95% 覆盖率)
Load life 负载寿命	ΔR ≤ ±3%	Soldering heat 耐焊接热	ΔR ≤ ±1%
Humidity (Steady State) 恒定湿热	ΔR ≤ ±3%		

### Ordering Procedure (Example: Thin Film TC06 1/8W 5% 50PPM 100Ω T/R-5000)

订购方式 (例如: TC06 1/8W 5% 50PPM 100Ω T/R-5000)

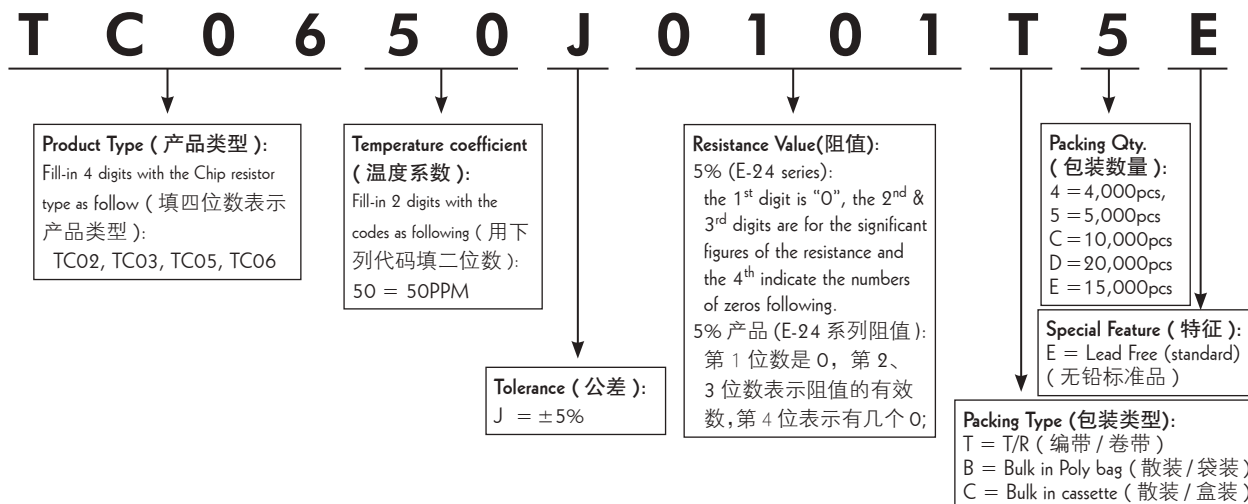

Feature (特性)

- High density, more than 1 resistors in one small case 高度密集, 多个电阻在一个表贴封装中
- Improvement of placement efficiency 装配效率高
- Tape/Reel packaging is suitable for automatic placement machine 编带卷装适合自动化机器
- Superior solderability 优越焊接性
- Application: Master board, CD & DVD Rom, Hard Disk, RAM  
应用于 CD、DVD、硬盘、内存、主板等



	2D02	4D02	4D03	16P8
Dimension 规格 (mm)				
Equivalent Circuit Diagram 等效 电路图				

Type (类型)	2D02	4D02	4D03	16P8
Rated power (功率) 70°C	1/16W	1/16W	1/16W	1/16W
Max. Working Voltage 最大工作电压	50V	50V	50V	50V
Max. Overload Voltage 最大过负荷电压	100V	100V	100V	100V
Dielectric Withstanding Voltage 绝缘耐压	100V	100V	300V	300V
Resistance Range 阻值范围	5% (E-24 ):10Ω~1MΩ 1% (E-96 ): 10Ω~1MΩ	5% (E-24 ):10Ω~1MΩ 1% (E-96 ): 10Ω~1MΩ	5% (E-24 ): 1Ω~1MΩ 1% (E-96 ): 1Ω~1MΩ	5% (E-24 ): 1Ω~1MΩ 1% (E-96 ): 1Ω~1MΩ
Temperature Coefficient 温度系数	±200PPM/°C	±200PPM/°C	≥10Ω: ±200PPM/°C <10Ω: ±400PPM/°C	≥10Ω: ±200PPM/°C <10Ω: ±400PPM/°C
Operating Temperature 工作温度范围	-55°C~+155 °C	-55°C~+155 °C	-55°C~+155 °C	-55°C~+155 °C
Resistance Value of Jumper 零欧姆电阻阻值	<50mΩ	<50mΩ	<50mΩ	<50mΩ
Rated Current of Jumper 零欧姆电阻额定电流	1A	1A	1A	1A

Performance Specification (性能)

Short-time overload	短时间过负荷	±(2.0% ±0.1Ω) Max.(最大)
Insulation resistance	绝缘电阻	≥1,000MΩ
Dielectric withstanding voltage	绝缘耐压	No evidence of flashover, mechanical damage, arcing or insulation breakdown 无击穿, 飞弧及可见机械性损伤
Terminal bending	端子弯曲	±(1.0% ±0.05Ω) Max.(最大)
Soldering heat	耐焊接热	ΔR/R ≤ ±(1.0% ±0.05Ω)
Solderability	可焊性	Min. 95% coverage (最少 95% 覆盖率)
Temperature cycling	温度循环	ΔR/R ≤ ±(1.0% ±0.05Ω)
Load lie in humidity	湿度寿命	±(3.0% ±0.1Ω) Max.(最大)
Load life	负载寿命	±(3.0% ±0.1Ω) Max.(最大)

- Please refer to page 5 for the information of Ordering Procedure (Part No.)  
订购方式, 请参考第 5 页 (料号)

### Feature (特性)

- High density, more than 1 resistors in one small case 高度密集，多个电阻在一个表贴封装中
- The Concave design in terminal enlarge the Soldering plate area 内凹设计，扩大端头锡焊面积
- The Concave design to reduce the terminal breaking risk 内凹设计，防止端头断裂
- Improvement of placement efficiency 装配效率高
- Application: RAM, CD & DVD Rom, Hard Disk, Master board  
应用于CD、DVD、硬盘、内存、主板等

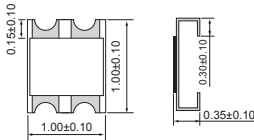
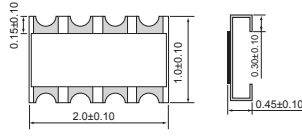
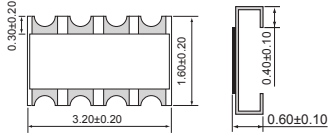
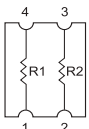
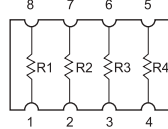
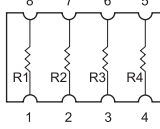

	2C02	4C02	4C03
Dimension 规格 (mm)			
Equivalent Circuit Diagram 等效 电路图	 <p>R1=R2</p>	 <p>R1=R2=R3=R4</p>	 <p>R1=R2=R3=R4</p>

Type (类型)	2C02	4C02	4C03
Rated power (功率) 70°C	1/16W	1/16W	1/16W
Max. Working Voltage 最大工作电压	50V	50V	50V
Max. Overload Voltage 最大过负荷电压	100V	100V	100V
Dielectric Withstanding Voltage 绝缘耐压	100V	100V	300V
Resistance Range 阻值范围	5% (E-24): 10Ω~1MΩ 1% (E-96): 10Ω~1MΩ	5% (E-24): 10Ω~1MΩ 1% (E-96): 10Ω~1MΩ	5%, 1%: 1Ω~1M
Temperature Coefficient 温度系数	±200PPM/°C	±200PPM/°C	≥10Ω: ±200PPM/°C <10Ω: ±400PPM/°C
Operating Temperature 工作温度范围	-55°C~+155°C	-55°C~+155 °C	-55°C~+155 °C
Resistance Value of Jumper 零欧姆电阻阻值	<50mΩ	<50mΩ	<50mΩ
Rated Current of Jumper 零欧姆电阻额定电流	1A	1A	1A

### Performance Specification (性能)

Short-time overload	短时间过负荷	±(2.0% ±0.1Ω) Max.(最大)
Insulation resistance	绝缘电阻	≥1,000MΩ
Dielectric withstanding voltage	绝缘耐压	No evidence of falshover, mechanical damage, arcing or insulation breakdown 无击穿，飞弧及可见机械性损伤
Terminal bending	端子弯曲	±(1.0% ±0.05Ω) Max. (最大)
Soldering heat	耐焊接热	ΔR/R ≤ ±(1.0% ±0.05Ω)
Solderability	可焊性	Min. 95% coverage (最少 95% 覆盖率)
Temperature cycling	温度循环	ΔR/R ≤ ±(1.0% ±0.05Ω)
Load life in humidity	湿度寿命	±(3.0% ±0.1Ω) Max.(最大)
Load life	负载寿命	±(3.0% ±0.1Ω) Max.(最大)

- Please refer to page 5 for the information of Ordering Procedure (Part No.)  
订购方式，请参考第5页(料号)

Feature (特性)

- High density, more than 1 resistors in one small case 高度密集, 多个电阻在一个表贴封装中
- Improvement of placement efficiency 装配效率高
- Tape/Reel packaging is suitable for automatic placement machine 编带卷装适合自动化机器
- Superior solderability 优越焊锡性



Dimension (尺寸) (mm)

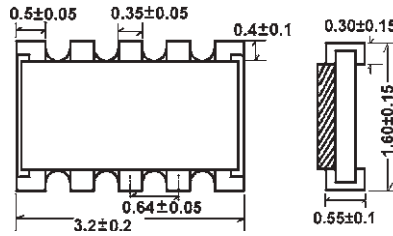

Equivalent Circuit Diagram (等效电路图)

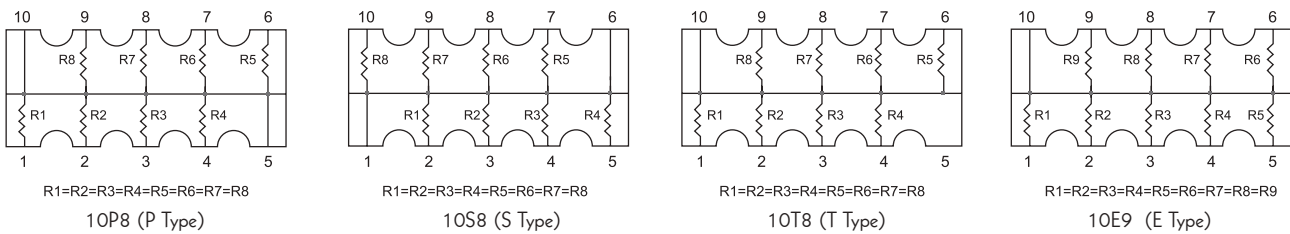

Performance Specification (性能)

Rated Power at 70°C	功率	1/32W [1/16W special provide (可特别提供)]
Max. Working Voltage	最大工作电压	25V
Max. Overload Voltage	最大过负荷电压	50V
Dielectric withstanding Voltage	绝缘耐压	50V
Operating temperature	工作温度	-55°C ~ +155 °C
Resistance Range	阻值范围	5%(E-24 series) & 1%(E-24,E-96 series): 10Ω~1MΩ 5%(E-24 系列) & 1%(E-24,E-96 系列): 10Ω~1MΩ
Resistance Value of Jumper	零欧姆电阻阻值	< 50mΩ
Rated Current of Jumper	零欧姆电阻额定电流	0.5A
Temperature Coefficient	温度系数	±200PPM/°C
Short-time overload	短时间过负荷	±(2.0% ±0.05Ω) Max.(最大)
Insulation resistance	绝缘电阻	≥ 1,000MΩ
Dielectric withstanding voltage	绝缘耐压	No evidence of flashover, mechanical damage, arcing or insulation breakdown 无击穿, 飞弧及可见机械性损伤
Terminal bending	端子弯曲	±(1.0% ±0.05Ω) Max.(最大)
Soldering heat	耐焊接热	ΔR/R ≤ ±(1.0% ±0.05Ω)
Solderability	可焊性	Min.95% coverage (最少 95% 覆盖率)
Load life in humidity	湿度寿命	±(3.0% ±0.1Ω) Max.(最大)
Load life	负载寿命	±(3.0% ±0.1Ω) Max.(最大)

• Please refer to page 5 for the information of Ordering Procedure (Part No.)  
订购方式, 请参考第 5 页 (料号)

### Dimension of Paper Taping (纸带尺寸)(mm)

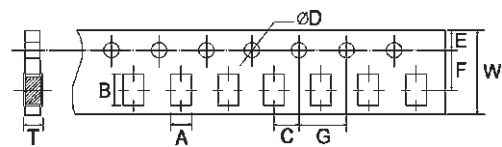
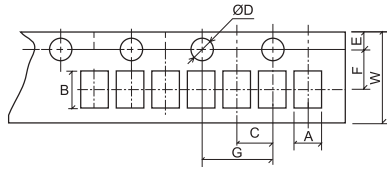

01005 0201 0402 HP02 HQ02 NM02 TC02 2C02 4C02 4D02 2D02

0603 0805 1206 1210 2010 0508 0612 1020 HQ03 HQ05 HQ06 HQ07 HQ10 HP03 HP05 HP06 HP07 HP10 HV03 HV05 HV06 HV07 HV10 NM03 NM05 NS03 NS05 NS06 AS03 AS05 AS06 PS05 PS06 PS07 CS03 CS05 CS06 CS07 CS10 TC03 TC05 TC06 TC07 TR05 TR06 TP03 TP05 TP06 4D03 4C03 10P8 10S8 10T8 10E9 16P8

Type (类型)	A±0.2	B±0.2	C±0.05	Ø D $\begin{smallmatrix} +0.1 \\ 0 \end{smallmatrix}$	E±0.1	F±0.05	G±0.1	W±0.2	T±0.1
01005	0.24±0.05	0.45±0.05	2.0	1.5	1.75	3.5	4.0	8.0	0.40
0201	0.40±0.05	0.70±0.05	2.0	1.5	1.75	3.5	4.0	8.0	0.42
0402, HP02, HQ02, NM02, TC02	0.65	1.15	2.0	1.5	1.75	3.5	4.0	8.0	0.45
0603, AS03, CS03, HP03, HQ03, HV03, NM03, NS03, TC03, TP03	1.10	1.90	2.0	1.5	1.75	3.5	4.0	8.0	0.67
0508, 0805, AS05, CS05, HP05, HQ05, HV05, NM05, NS05, PS05, TC05, TR05, TP05	1.65	2.40	2.0	1.5	1.75	3.5	4.0	8.0	0.81
0612, 1206, AS06, CS06, HP06, HQ06, HV06, NS06, PS06, TC06, TR06, TP06	2.00	3.60	2.0	1.5	1.75	3.5	4.0	8.0	0.81
1210, CS07, HP07, HQ07, HV07, PS07, TC07	2.80	3.50	2.0	1.5	1.75	3.5	4.0	8.0	0.75
2010, HP10, HQ10, HV10, 1020, CS10	2.80	5.40	2.0	1.5	1.75	5.5	4.0	12.0	0.75
2D02, 2C02	1.20	1.20	2.0	1.5	1.75	3.5	4.0	8.0	0.45
4D02, 4C02	1.20	2.20	2.0	1.5	1.75	3.5	4.0	8.0	0.70
4D03, 4C03	2.00	3.60	2.0	1.5	1.75	3.5	4.0	8.0	0.83
10P8, 10S8, 10T8, 10E9	2.00	3.60	2.0	1.5	1.75	3.5	4.0	8.0	0.85
16P8	1.80	4.30	2.0	1.5	1.75	5.5	4.0	12.0	0.75

### Dimension of Embossed Taping (塑胶带尺寸)(mm)

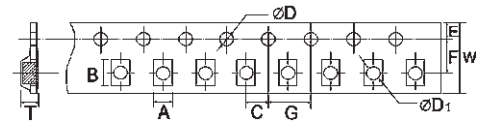

Type (类型)	A±0.2	B±0.2	C±0.05	Ø D $\begin{smallmatrix} +0.1 \\ 0 \end{smallmatrix}$	Ø D <sub>1</sub> $\begin{smallmatrix} +0.25 \\ 0 \end{smallmatrix}$	E±0.1	F±0.05	G±0.1	W±0.2	T±0.1
TC10	2.9	5.6	2.0	1.5	1.5	1.75	5.5	4.0	12	1.0
1218, 1812	3.5	4.8	2.0	1.5	1.5	1.75	5.5	4.0	12	1.0
1225, 2512, CS12, HP12, HV12, TC12, HQ12	3.5	6.7	2.0	1.5	1.5	1.75	5.5	4.0	12	1.0

### Dimension of Reel (卷轴尺寸)(mm)

Type (类型)	Tape 纸带	Qty. / Reel 数量 / 卷装	Tape Width 纸带宽	W ± 1
01005	Paper 纸带	20,000pcs	8mm	10
0201, 0402*, HP02, HQ02, NM02, TC02	Paper 纸带	10,000pcs*	8mm	10
0603, AS03, CS03, HP03, HQ03, HV03, NM03, NS03, TC03, TP03	Paper 纸带	5,000pcs	8mm	10
0508, 0805, AS05, CS05, HP05, HQ05, HV05, NM05, NS05, PS05, TC05, TR05, TP05	Paper 纸带	5,000pcs	8mm	10
0612, 1206, AS06, CS06, HP06, HQ06, HV06, NS06, PS06, TC06, TR06, TP06	Paper 纸带	5,000pcs	8mm	10
1210, CS07, HP07, HQ07, HV07, PS07, TC07	Paper 纸带	5,000pcs	8mm	10
1020, 2010, CS10, HP10, HQ10, HV10	Paper 纸带	5,000pcs	8mm	10
1218, 1812, TC10	Embossed 塑胶带	4,000pcs	12mm	13.8
1225, 2512, CS12, HP12, HV12, TC12, HQ12	Embossed 塑胶带	4,000pcs	12mm	13.8
2D02, 2C02	Paper 纸带	10,000pcs	8mm	10
4D02, 4C02	Paper 纸带	10,000pcs	8mm	10
4D03, 4C03	Paper 纸带	5,000pcs	8mm	10
10P8, 10S8, 10T8, 10E9	Paper 纸带	5,000pcs	8mm	10
16P8	Paper 纸带	4,000pcs	12mm	13.8

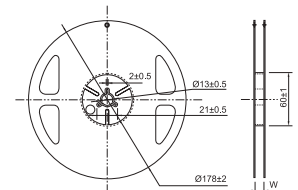

\*Remark: 15,000 pcs/reel package could be offered for 0402 size. (备注: 0402 可提供 15,000 只包装)

### Dimension of Bulk Cassette (散装箱尺寸) (mm)

36(H)×12(W)×110(L)

Bulk Cassette packing available on a case to case basis (散装可特别提供)



Feature (特性)

- Miniature, high density packaging  
小型高密度封装
- High reliability  $R_{10}O_2$  paste  
使用高稳定性  $R_{10}O_2$  电阻材料

Application (应用)

- Control circuit V.C.R. (V.C.R.控制电路)
- Air-conditioner (空调)
- Computer, color TV (计算机, 彩电)
- Facsimile (传真机)



Dimension (尺寸) (mm)

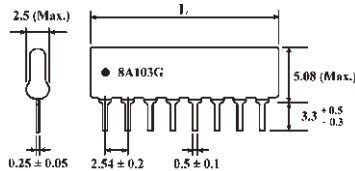

"•" indicate the 1st pin (表示第一脚位置)

Dimension of L (Max.) (L的最大尺寸)

4 PIN : 10.2mm	10 PIN : 25.4mm
5 PIN : 12.7mm	11 PIN : 28.0mm
6 PIN : 15.3mm	12 PIN : 30.5mm
7 PIN : 17.8mm	13 PIN : 33.1mm
8 PIN : 20.4mm	14 PIN : 35.6mm
9 PIN : 22.9mm	

Derating Curve (降功率曲线)

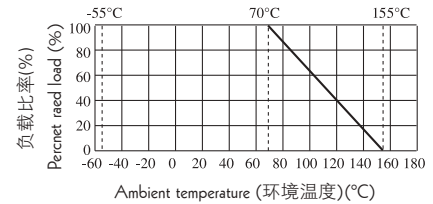

Circuit Structure (电路结构)

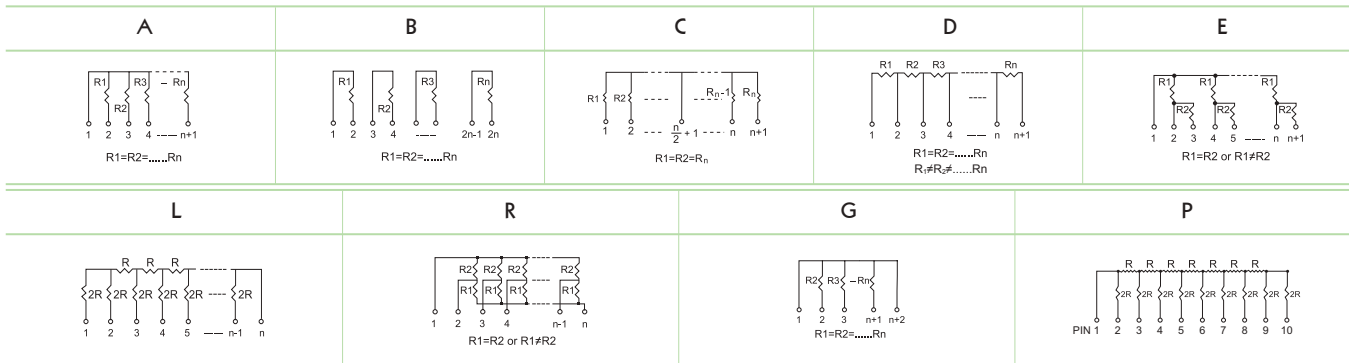

\* Custom Design Circuit could be available on a case to case basis. (可按客户特殊要求定制)

Power Rating (功率) 70°C	Max. Working Voltage 最大工作电压	Max. Overload Voltage 最大过负荷电压	Dielectric Withstanding Voltage 绝缘耐压	Resistance Range 阻值范围	Tolerance 公差	Operating Temperature 工作温度范围
B type (B型): 0.2W Others (其它类型): 0.125W	100V	150V	200V	R Type (R型): 100Ω~10KΩ Others (其它类型): 10Ω~1MΩ	±2% ±5%	-55°C~+155°C

Marking (Single Value) [标示: (单个阻值)]:

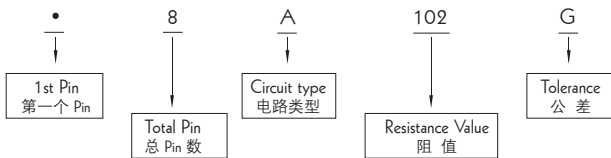

Marking (Dual Value) [标示: (双阻类型)]:

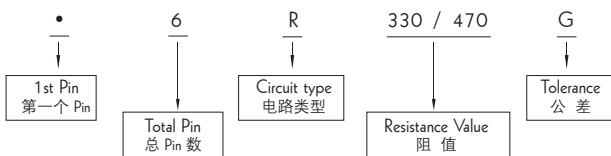

Dual Value (双阻型阻值系列) (R1/R2) (Ohm)

160 / 240	330 / 390
180 / 390	330 / 470
220 / 270	1.5K / 3.5K
220 / 330	3.0K / 6.2K

\* Special Value available on a case to case basis. (另可按客户特殊要求订做)

Performance Specifications (性能)

Temperature coefficient 温度系数	50Ω ~ 1MΩ: ±200PPM/°C < 50Ω & > 1MΩ: ±250PPM/°C
Short-time overload 短时间过负荷	$\Delta R/R \leq \pm(0.5\% + 0.1\Omega)$
Insulation resistance 绝缘电阻	$\geq 10,000M\Omega$
Dielectric withstanding voltage 绝缘耐压	No Evidence of flashover, arcing or insulation breakdown (无击穿、飞弧及可见机械损伤)
Terminal strength 端子强度	$\Delta R/R \leq \pm(0.5\% + 0.1\Omega)$
Soldering heat 耐焊接热	$\Delta R/R \leq \pm(0.5\% + 0.1\Omega)$
Solderability 可焊性	Min. 95% coverage (最少 95% 覆盖率)
Thermal shock 热冲击	$\Delta R/R \leq \pm(0.5\% + 0.1\Omega)$
Temperature cycling 温度循环	$\Delta R/R \leq \pm(0.5\% + 0.1\Omega)$
Load life in humidity 湿度寿命	$\Delta R/R \leq \pm(3\% + 0.1\Omega)$
Load life 负载寿命	$\Delta R/R \leq \pm(3\% + 0.1\Omega)$



### Standard Packing of Resistor Network (网络电阻器的标准包装)

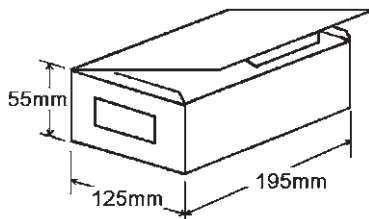

Pins Pins 数	Weight of 1,000pcs 1,000 只重量	Qty. per Bag 每袋数量	Qty. per Box 每盒数量	Qty. per Carton 每箱数量
4	210g	500	5,000	75,000
5	250g	400	4,000	60,000
6	320g	300	3,000	45,000
7	360g	200	2,000	30,000
8	430g	200	2,000	30,000
9	450g	200	2,000	30,000
10	530g	150	1,500	22,500
11	600g	100	1,000	15,000
12	650g	100	1,000	15,000
13	710g	100	1,000	15,000
14	770g	100	1,000	15,000

### Ordering Procedure (Example: RNL A type 10 PIN 2% 10KΩ B/B)

订购方式 (例如: RNL A 型 10 PIN 2% 10KΩ B/B)

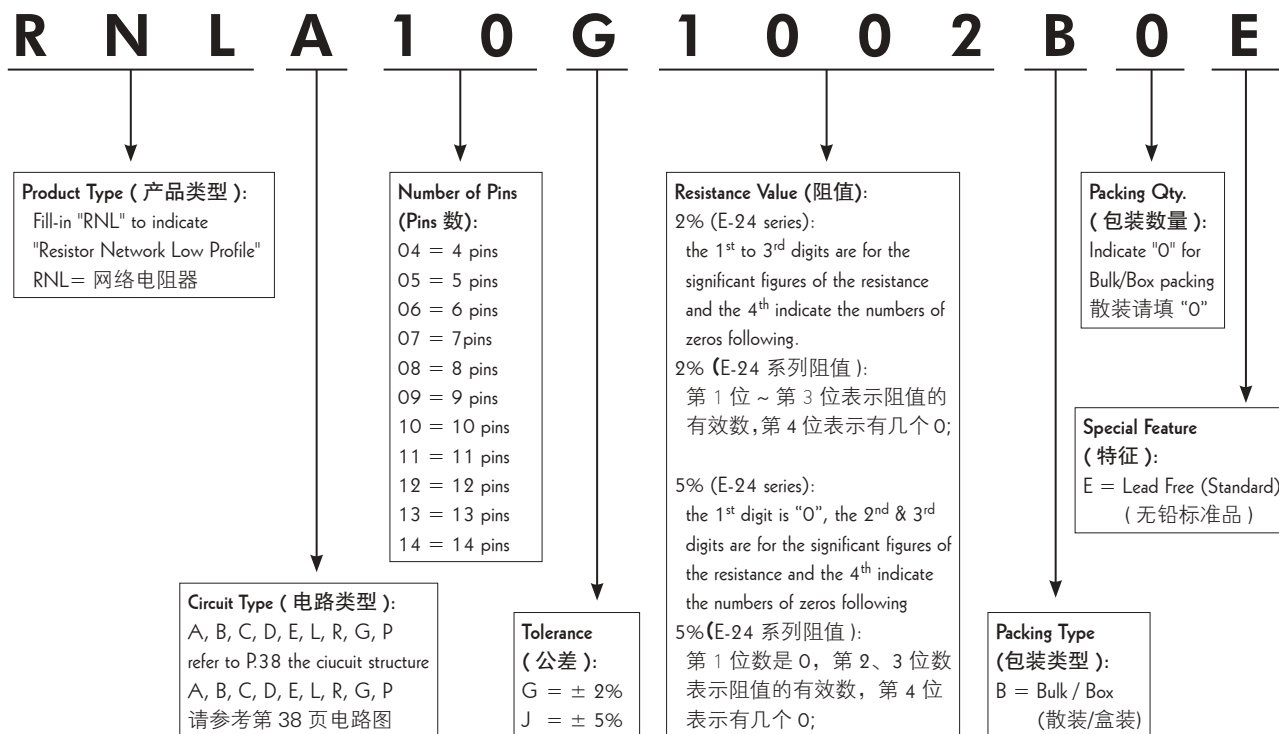

Feature (特性)

- Miniature, high density packaging  
小型高密度封装
- High reliability  $R_{10}O_2$  paste  
使用高稳定性  $R_{10}O_2$  电阻材料

Application (应用)

- Control circuit V.C.R. (V.C.R.控制电路)
- Air-conditioner (空调)
- Computer, color TV (计算机, 彩电)
- Facsimile (传真机)

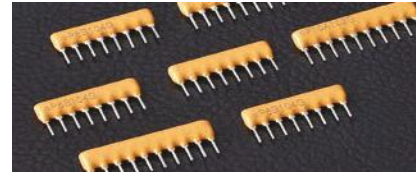

Dimension (尺寸) (mm)

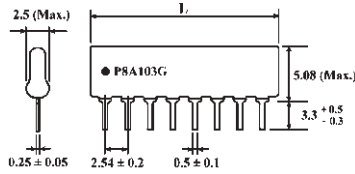

"•" indicate the 1st pin (表示第一脚位置)

Dimension of L (Max.) (L的最大尺寸)

4 PIN : 10.2mm	10 PIN : 25.4mm
5 PIN : 12.7mm	11 PIN : 28.0mm
6 PIN : 15.3mm	12 PIN : 30.5mm
7 PIN : 17.8mm	13 PIN : 33.1mm
8 PIN : 20.4mm	14 PIN : 35.6mm
9 PIN : 22.9mm	

Derating Curve (降功率曲线)

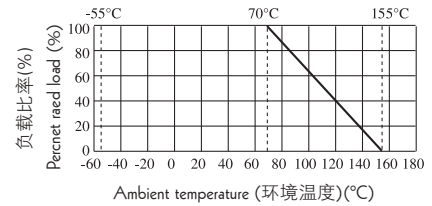

Circuit Structure (电路结构)

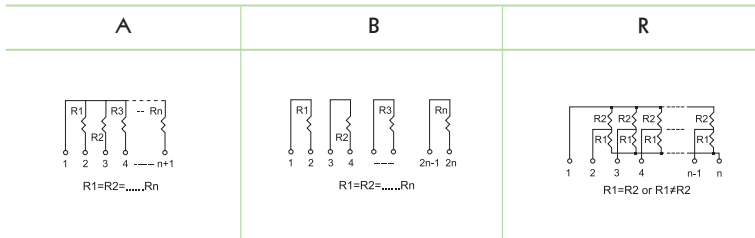

Package Power Ratings (包装功率等级)(Watts)

Pkg.	Package Power Rating 包装功率等级	Pkg.	Package Power Rating 包装功率等级
4	0.5W	10	1.25W
5	0.63W	11	1.38W
6	0.75W	12	1.5W
7	0.88W	13	1.63W
8	1.0W	14	1.75W
9	1.13W		

\* Custom Design Circuit could be available on a case to case basis. (可按客户特殊要求定制)

Power Rating (功率) 70°C	Max. Working Voltage 最大工作电压	Max. Overload Voltage 最大过负荷电压	Dielectric Withstanding Voltage 绝缘耐压	Resistance Range 阻值范围	Tolerance 公差	Operating Temperature 工作温度范围
A: 0.2W				10Ω ~ 1MΩ	±2%	
B: 0.3W	100V	150V	200V	10Ω ~ 1MΩ	±5%	-55°C ~ +155°C
R: 0.2W				100Ω ~ 10KΩ		

Marking (Single Value) [标示: (单个阻值)]:

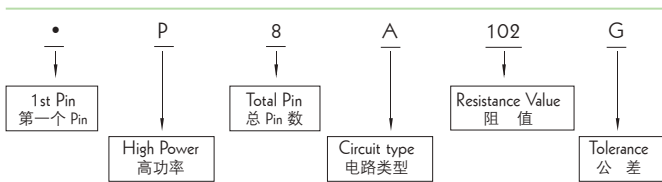

Marking (Dual Value) [标示: (双阻类型)]:

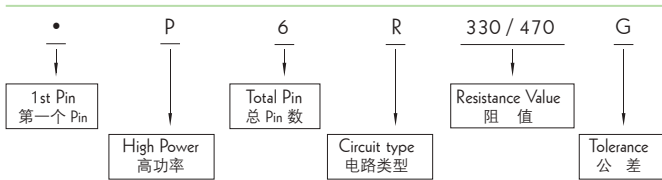

Dual Value(双阻型阻值系列) (R1/R2) (Ohm)

160 / 240	330 / 390
180 / 390	330 / 470
220 / 270	1.5K / 3.5K
220 / 330	3.0K / 6.2K

\* Special Value available on a case to case basis. (另可按客户特殊要求订做)

Performance Specifications (性能)

Temperature coefficient 温度系数	50Ω-1MΩ: ±100PPM/°C <50Ω & >1MΩ: ±250PPM/°C
Short-time overload 短时间过负荷	$\Delta R/R \leq \pm(0.25\% + 0.1\Omega)$
Insulation resistance 绝缘电阻	$\geq 10,000M\Omega$
Dielectric withstanding voltage 绝缘耐压	No Evidence of flashover, arcing or insulation breakdown (无击穿、飞弧及可见机械损伤)
Terminal strength 端子强度	$\Delta R/R \leq \pm(0.25\% + 0.1\Omega)$
Soldering heat 耐焊接热	$\Delta R/R \leq \pm(0.5\% + 0.1\Omega)$
Solderability 可焊性	Min. 95% coverage (最少 95% 覆盖率)
Thermal shock 热冲击	$\Delta R/R \leq \pm(0.25\% + 0.1\Omega)$
Temperature cycling 温度循环	$\Delta R/R \leq \pm(0.5\% + 0.1\Omega)_{max}$ (最大)
Load life in humidity 湿度寿命	$\Delta R/R \leq \pm(0.5\% + 0.1\Omega)$
Load life 负载寿命	$\Delta R/R \leq \pm(1\% + 0.1\Omega)$

### Standard Packing of Resistor Network (网络电阻器的标准包装)

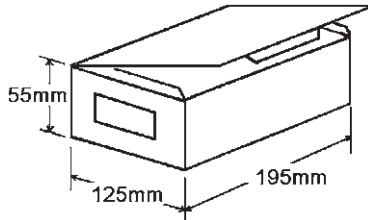

Pins Pins 数	Weight of 1,000pcs 1,000 只重量	Qty. per Bag 每袋数量	Qty. per Box 每盒数量	Qty. per Carton 每箱数量
4	210g	500	5,000	75,000
5	250g	400	4,000	60,000
6	320g	300	3,000	45,000
7	360g	200	2,000	30,000
8	430g	200	2,000	30,000
9	450g	200	2,000	30,000
10	530g	150	1,500	22,500
11	600g	100	1,000	15,000
12	650g	100	1,000	15,000
13	710g	100	1,000	15,000
14	770g	100	1,000	15,000

### Ammo Pack of Resistor Network (网络电阻器编带包装)

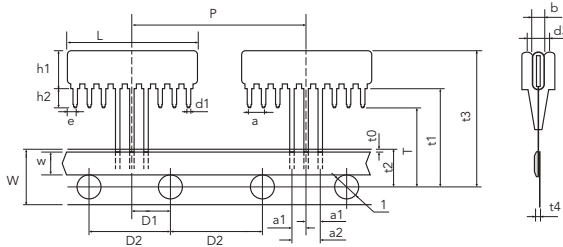

\* ... n=Pin Count

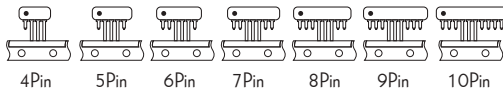

Dimension 尺寸 (mm)		Dimension 尺寸 (mm)	
h1	Max 5.08	t 0	2.0max
L	Max 2.54 *n	t 1	18.99±0.5
a	2.54±0.25	t 2	9.0±0.5
d1	0.5±0.1	t 3	24.46 Max
P	25.4±1.0	t 4	1.5max
W	18±0.5	l	∅4.0±0.3
w	5.0min	h2	3.0±0.5
P1	6.35±0.7	a1	2.54±0.25
P2	12.7±0.3	a2	5.08±0.3
b	Max2.49	d3	2.0 Max
T	16±0.5	/	/

### Packing quantity (包装数量)

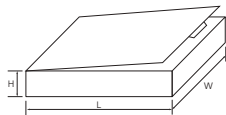

The inside box sizes 内盒尺寸:

4~9pin: 320(L) × 207(W) × 40(H)mm

10pin: 315(L) × 295(W) × 40(H)mm

Pins Pins 数	Qty. per Box 每盒数量	Qty. per Carton 每箱数量
4~10	1,000	12,000

### Ordering Procedure (Example: RPL A type 10 PIN 2% 10KΩ B/B)

订购方式 (例如: RPL A 型 10 PIN 2% 10KΩ B/B)

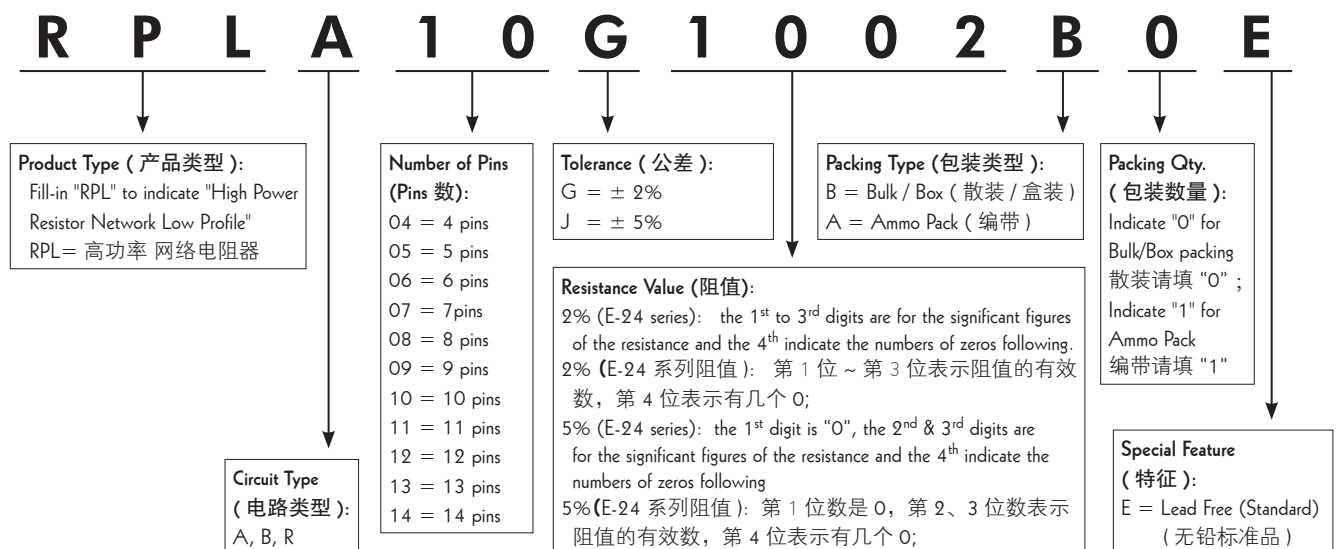

**Feature (特性)**

- Miniature, high density packaging  
小型高密度封装
- High reliability  $R_{10}O_2$  paste  
使用高稳定性  $R_{10}O_2$  电阻材料

**Application (应用)**

- Control circuit V.C.R. (V.C.R.控制电路)
- Air-conditioner (空调)
- Computer, color TV (计算机, 彩电)
- Facsimile (传真机)

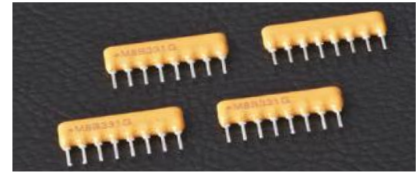

**Dimension (尺寸) (mm)**

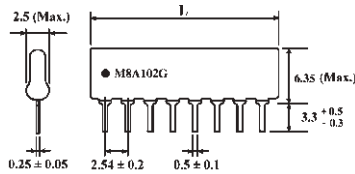

"•" indicate the 1st pin (表示第一脚位置)

**Dimension of L (Max.) (L的最大尺寸)**

4 PIN : 10.2mm	10 PIN : 25.4mm
5 PIN : 12.7mm	11 PIN : 28.0mm
6 PIN : 15.3mm	12 PIN : 30.5mm
7 PIN : 17.8mm	13 PIN : 33.1mm
8 PIN : 20.4mm	14 PIN : 35.6mm
9 PIN : 22.9mm	

**Derating Curve (降功率曲线)**

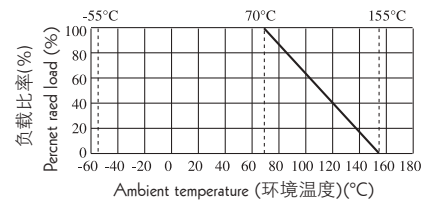

**Circuit Structure (电路结构)**

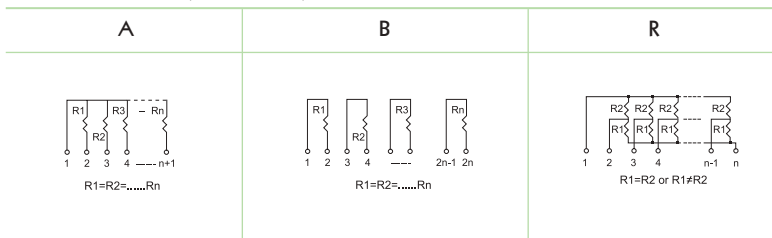

**Package Power Ratings (包装功率等级)(W)**

Pkg.	Package Power Rating 包装功率等级	Pkg.	Package Power Rating 包装功率等级
4	0.6W	10	1.50W
5	0.75W	11	1.65W
6	0.9W	12	1.80W
7	1.05W	13	1.95W
8	1.20W	14	2.10W
9	1.35W		

\* Custom Design Circuit could be available on a case to case basis. (可按客户特殊要求定制)

Power Rating (功率) 70°C	Max. Working Voltage 最大工作电压	Max. Overload Voltage 最大过负荷电压	Dielectric Withstanding Voltage 绝缘耐压	Resistance Range 阻值范围	Tolerance 公差	Operating Temperature 工作温度范围
A: 0.25W				10Ω ~ 1MΩ	±2%	-55°C ~ +155°C
B: 0.4W	100V	150V	200V	10Ω ~ 1MΩ	±5%	
R: 0.25W				100Ω ~ 10KΩ		

**Marking (Single Value) [标示: (单个阻值)]:**

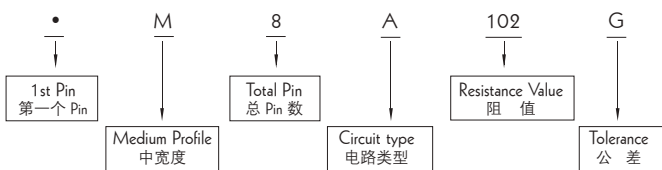

**Performance Specifications (性能)**

Temperature coefficient 温度系数	50Ω-1MΩ: ±100PPM/°C <50Ω & >1MΩ: ±250PPM/°C
Short-time overload 短时间过负荷	$\Delta R/R \leq \pm(0.25\% + 0.1\Omega)$
Insulation resistance 绝缘电阻	$\geq 10,000M\Omega$
Dielectric withstanding voltage 绝缘耐压	No Evidence of flashover, arcing or insulation breakdown (无击穿、飞弧及可见机械损伤)
Terminal strength 端子强度	$\Delta R/R \leq \pm(0.25\% + 0.1\Omega)$
Soldering heat 耐焊接热	$\Delta R/R \leq \pm(0.5\% + 0.1\Omega)$
Solderability 可焊性	Min. 95% coverage (最少 95% 覆盖率)
Thermal shock 热冲击	$\Delta R/R \leq \pm(0.25\% + 0.1\Omega)$
Temperature cycling 温度循环	$\Delta R/R \leq \pm(0.5\% + 0.1\Omega)_{max}$ (最大)
Load life in humidity 湿度寿命	$\Delta R/R \leq \pm(0.5\% + 0.1\Omega)$
Load life 负载寿命	$\Delta R/R \leq \pm(1\% + 0.1\Omega)$

**Marking (Dual Value) [标示: (双阻类型)]:**

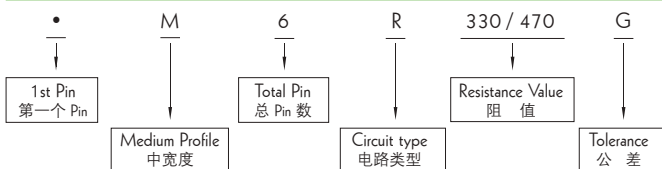

**Dual Value(双阻型阻值系列) (R1/R2) (Ohm)**

160 / 240	330 / 390
180 / 390	330 / 470
220 / 270	1.5K / 3.5K
220 / 330	3.0K / 6.2K

\* Special Value available on a case to case basis. (另可按客户特殊要求订做)

### Standard Packing of Resistor Network (网络电阻器的标准包装)

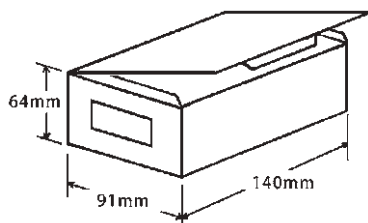

Pins Pins 数	Weight of 1,000pcs 1,000 只重量	Qty. per Bag 每袋数量	Qty. per Box 每盒数量	Qty. per Carton 每箱数量
4	240	100	1,000	30,000
5	300	100	1,000	30,000
6	360	100	1,000	30,000
7	420	100	1,000	30,000
8	480	100	1,000	30,000
9	540	50	500	15,000
10	610	50	500	15,000
11	670	50	500	15,000
12	730	50	500	15,000
13	790	50	500	15,000
14	850	50	500	15,000

### Ordering Procedure (Example: RNM A type 10 PIN 2% 10KΩ B/B)

订购方式 (例如: RNM A 型 10 PIN 2% 10KΩ B/B)

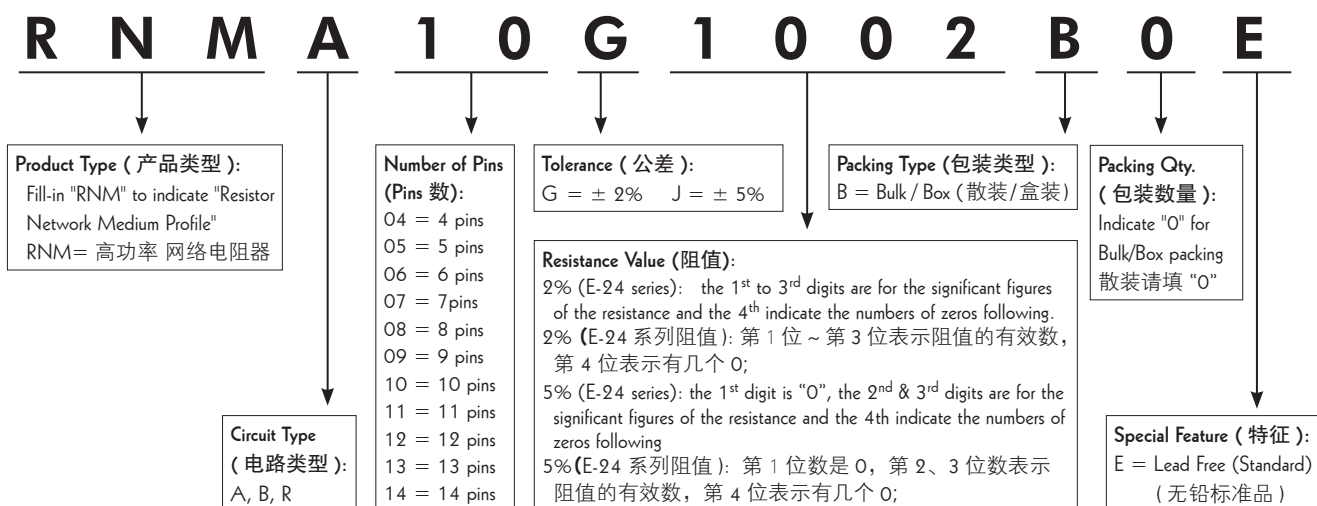

Feature (特性)

- Miniature, high density packaging  
小型高密度封装
- High reliability  $R_{1}O_{2}$  paste  
使用高稳定性  $R_{1}O_{2}$  电阻材料

Application (应用)

- Control circuit V.C.R. (V.C.R.控制电路)
- Air-conditioner (空调)
- Computer, color TV (计算机, 彩电)
- Facsimile (传真机)

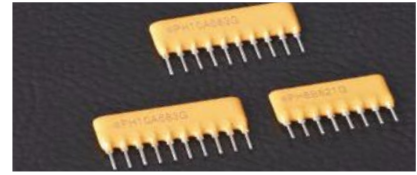

Dimension (尺寸) (mm)

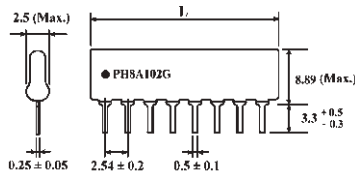

"•" indicate the 1st pin (表示第一脚位置)

Dimension of L (Max.) (L的最大尺寸)

4 PIN : 10.2mm	10 PIN : 25.4mm
5 PIN : 12.7mm	11 PIN : 28.0mm
6 PIN : 15.3mm	12 PIN : 30.5mm
7 PIN : 17.8mm	13 PIN : 33.1mm
8 PIN : 20.4mm	14 PIN : 35.6mm
9 PIN : 22.9mm	

Derating Curve (降功率曲线)

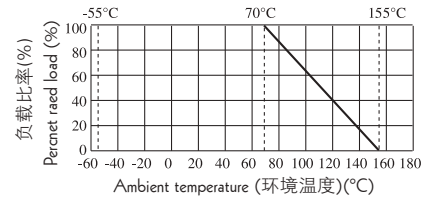

Circuit Structure (电路结构)

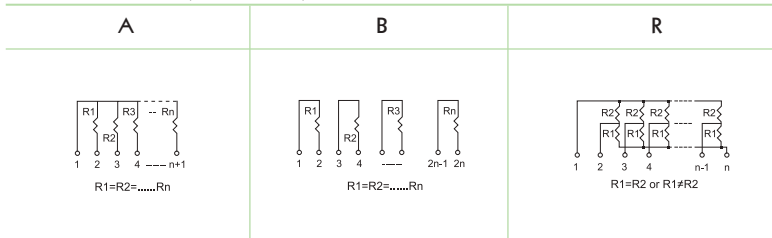

Package Power Ratings (包装功率等级)(W)

Pkg.	Package Power Rating 包装功率等级	Pkg.	Package Power Rating 包装功率等级
4	0.8W	10	2.0W
5	1.0W	11	2.2W
6	1.2W	12	2.4W
7	1.4W	13	2.6W
8	1.6W	14	2.8W
9	1.8W		

\* Custom Design Circuit could be available on a case to case basis. (可按客户特殊要求定制)

Power Rating (功率) 70°C	Max. Working Voltage 最大工作电压	Max. Overload Voltage 最大过负荷电压	Dielectric Withstanding Voltage 绝缘耐压	Resistance Range 阻值范围	Tolerance 公差	Operating Temperature 工作温度范围
A: 0.3W				10Ω ~ 1MΩ		
B: 0.5W	100V	150V	200V	10Ω ~ 1MΩ	±2%	-55°C ~ +155°C
R: 0.3W				100Ω ~ 10KΩ	±5%	

Marking (Single Value) [标示: (单个阻值)]:

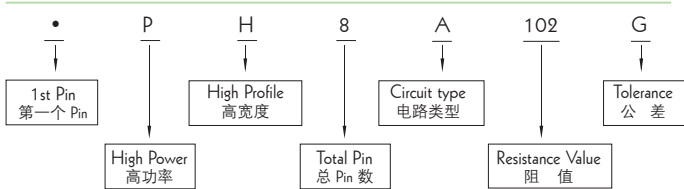

Marking (Dual Value) [标示: (双阻类型)]:

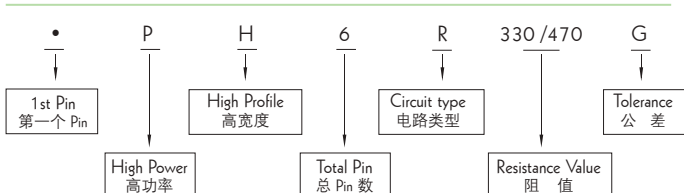

Dual Value(双阻型阻值系列) (R1/R2) (Ohm)

160 / 240	330 / 390
180 / 390	330 / 470
220 / 270	1.5K / 3.5K
220 / 330	3.0K / 6.2K

\* Special Value available on a case to case basis. (另可按客户特殊要求订做)

Performance Specifications (性能)

Temperature coefficient 温度系数	50Ω-1MΩ: ±100PPM/°C < 50Ω & > 1MΩ: ±250PPM/°C
Short-time overload 短时间过负荷	$\Delta R/R \leq \pm(0.25\% + 0.1\Omega)$
Insulation resistance 绝缘电阻	$\geq 10,000M\Omega$
Dielectric withstanding voltage 绝缘耐压	No evidence of flashover mechanical damage, arcing or insulation break down. (无击穿、飞弧及可见机械损伤)
Terminal strength 端子强度	$\Delta R/R \leq \pm(0.25\% + 0.1\Omega)$
Soldering heat 耐焊接热	$\Delta R/R \leq \pm(0.5\% + 0.1\Omega)$
Solderability 可焊性	Min. 95% coverage (最少 95% 覆盖率)
Thermal shock 热冲击	$\Delta R/R \leq \pm(0.25\% + 0.1\Omega)$
Temperature cycling 温度循环	$\Delta R/R \leq \pm(0.5\% + 0.1\Omega)_{max}$ (最大)
Load life in humidity 湿度寿命	$\Delta R/R \leq \pm(0.5\% + 0.1\Omega)$
Load life 负载寿命	$\Delta R/R \leq \pm(1\% + 0.1\Omega)$

### Standard Packing of Resistor Network (网络电阻器的标准包装)

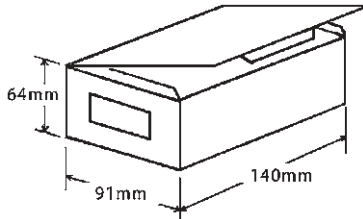

Pins Pins 数	Weight of 1,000pcs 1,000 只重量	Qty. per Bag 每袋数量	Qty. per Box 每盒数量	Qty. per Carton 每箱数量
4	330	100	1,000	30,000
5	410	100	1,000	30,000
6	490	100	1,000	30,000
7	570	100	1,000	30,000
8	660	50	1,500	15,000
9	760	50	500	15,000
10	870	50	500	15,000
11	950	50	500	15,000
12	1030	50	500	15,000
13	1130	50	500	15,000
14	1210	50	500	15,000

### Ordering Procedure (Example: RPH A type 10 PIN 2% 10KΩ B/B)

订购方式 (例如: RPH A 型 10 PIN 2% 10KΩ B/B)

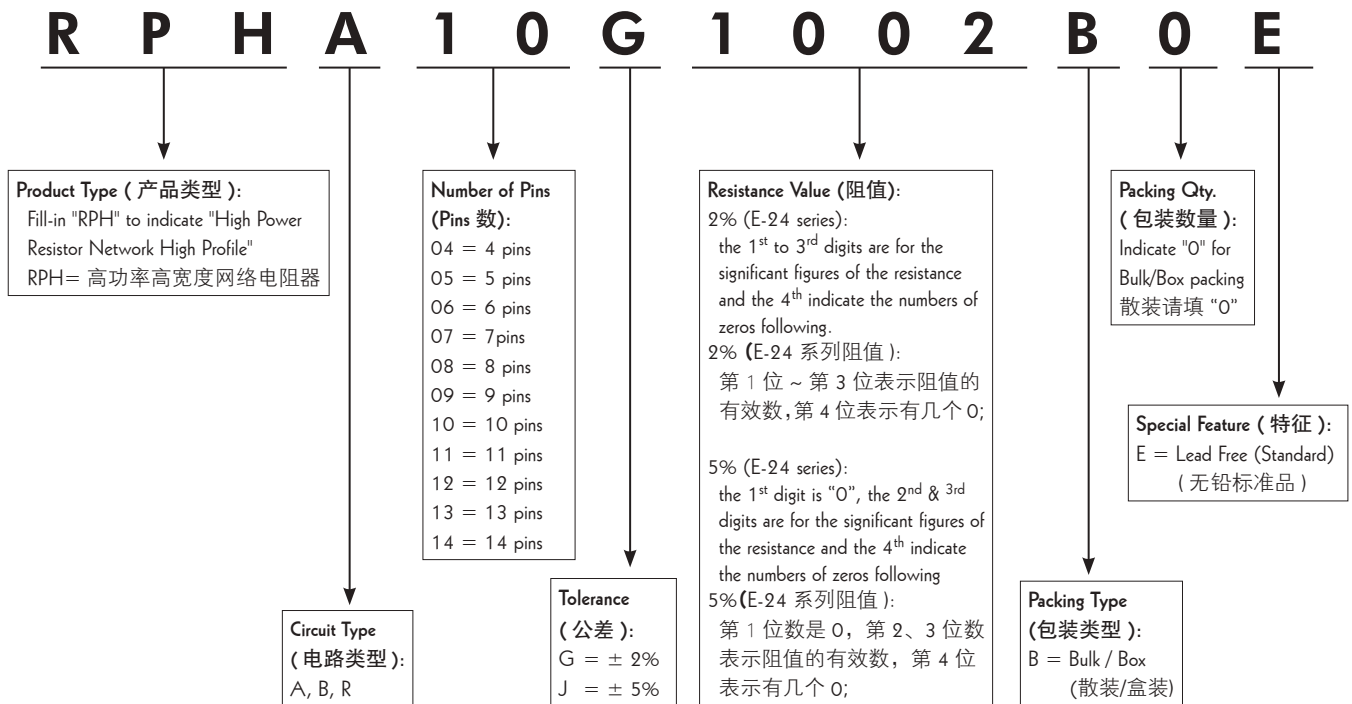

Feature (特性)

- Miniature, high density packaging  
小型高密度封装
- High reliability  $R_{10}O_2$  paste  
使用高稳定性  $R_{10}O_2$  电阻材料

Application (应用)

- Control circuit V.C.R. (V.C.R.控制电路)
- Air-conditioner (空调)
- Computer, color TV (计算机, 彩电)
- Facsimile (传真机)

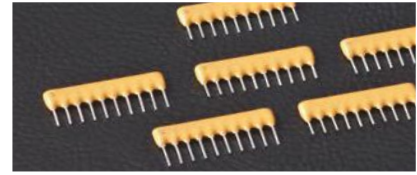

Dimension (尺寸) (mm)

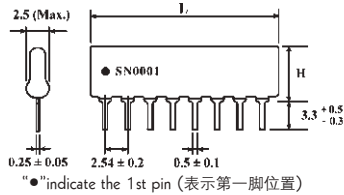

Derating Curve (降功率曲线)

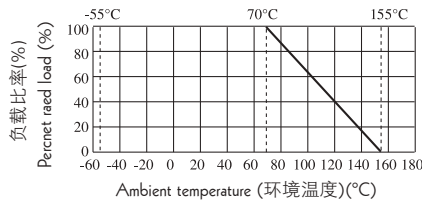

Marking (Single Value) [标示 (单一值)]



Circuit Structure (电路结构)

SN0001	SN0002	SN0003	SN0004
R1=500Ω ±5% R2=40K ±5% (TO R3 ±1%) R3=10K ±5% R4=50K ±5% R5=R7=100K ±5% (R6 TO R7 ±1%)	R1=33KΩ ±5% R2=22KΩ ±5%	R3=9K1 R4=120K R5=1K5 R7=52K5 R1=120K R14=24K R15=1K5 R16=7K5 R17=52K5 R6=36K R8=6K7K5 R9=11K R10=R11=R12=20K R13=11K	R1=520Ω R2=70Ω R3=121Ω R4=249Ω R5=1K33 R6=619K R7=174Ω R8=75Ω
Dimension of L (max) 尺寸 L (最大) 10PINS:25.4mm H (max) 5.08mm Power Rating at 70°C 功率 70°C 0.2W Max Working Voltage 最大工作电压 100V Max Overload Voltage 最大过负荷电压 150V Operating Temperature 工作温度 -55°C~+155°C	Dimension of L (max) 尺寸 L (最大) 10PINS:25.4mm H (max) 5.08mm Power Rating at 70°C 功率 70°C 0.2W Max Working Voltage 最大工作电压 100V Max Overload Voltage 最大过负荷电压 150V Operating Temperature 工作温度 -55°C~+155°C	Dimension of L (max) 尺寸 L (最大) 10PINS:43.2mm H (max) H (最大) 6.35mm Tolerance 公差 ±1% Power Rating at 70°C 功率 70°C 0.125W Max Working Voltage 最大工作电压 100V Max Overload Voltage 最大过负荷电压 200V Operating Temperature 工作温度 -55°C~+155°C	Dimension of L (max) 尺寸 L (最大) 9PINS:22.9mm H (max) H (最大) 5.08mm Tolerance 公差 ±1% Power Rating at 70°C 功率 70°C 0.125W Max Working Voltage 最大工作电压 100V Max Overload Voltage 最大过负荷电压 150V Operating Temperature 工作温度 -55°C~+155°C

\* Custom Design Circuit could be available on a case to case basis (可提供客户特殊要求之线路产品)

Performance Specifications (性能)

Temperature coefficient 温度系数	50Ω ~ 2.2MΩ: ±100PPM, <50Ω & >2.2MΩ: ±250PPM	Terminal strength 端子强度	ΔR/R ≤ ±(0.25% + 0.1Ω)
Short-time overload 短时间过负荷	ΔR/R ≤ ±(0.25% + 0.1Ω)	Soldering heat 耐焊接热	ΔR/R ≤ ±(0.5% + 0.1Ω)
Insulation resistance 绝缘电阻	≥ 10,000MΩ	Solderability 可焊性	Min. 95% coverage (最少 95% 覆盖率)
Dielectric withstanding voltage 绝缘耐压	No evidence of flashover mechanical damage, arcing or insulation break down. 无击穿、电弧及可见机械损伤	Thermal shock 热冲击	ΔR/R ≤ ±(0.25% + 0.1Ω)
		Temperature cycling 温度循环	ΔR/R ≤ ±(0.5% + 0.1Ω)max(最大)
		Humidity (Steady State) 恒定湿热	ΔR/R ≤ ±(0.5% + 0.1Ω)
		Load life 负载寿命	ΔR/R ≤ ±(1% + 0.1Ω)

Ordering Procedure (Example: RPL Special Network N0001 10PIN B/B)

订购方式 (例如: RPL 特殊网络电阻 N0001 10PIN B/B)

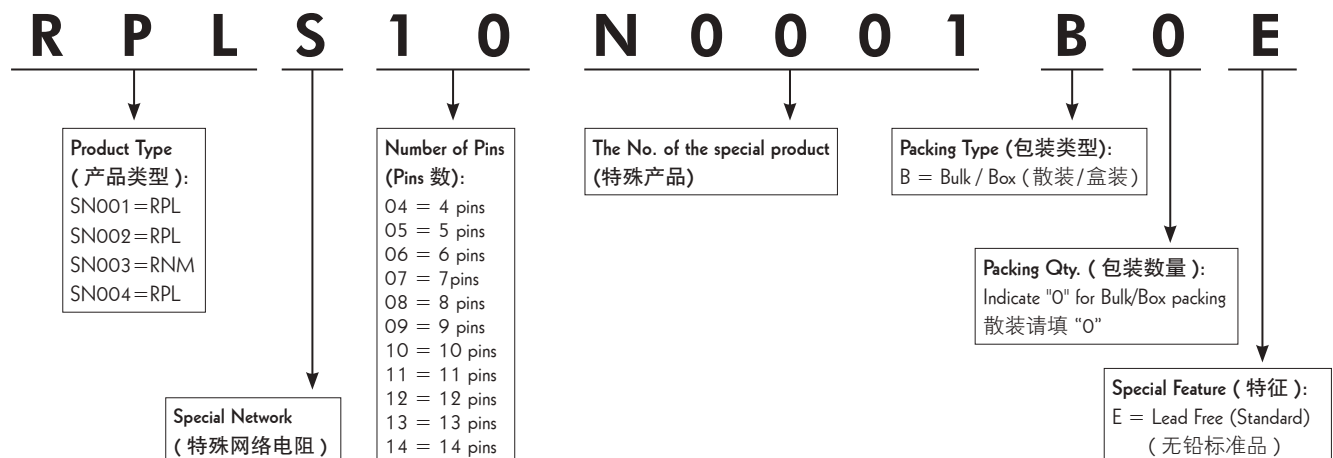



### Feature (特性)

- Low noise termination for CMOS. CMOS 低噪声
- Combined resistors and capacitors in SIP Package saves space 在排列电阻的基板上贴电容
- Reduced insertion time 减少插件时间, 提高效率
- Insulation resistance testing for reliability 可靠的绝缘电阻的测试

### Application (应用)

- Microwave ovens 微波炉
- Color TV 电视
- Radio 收音机

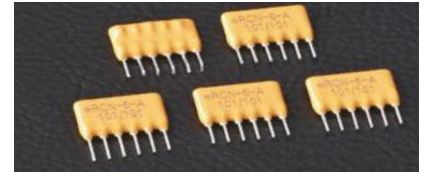

### Electrical Characteristics-Resistors (电阻特性)

Resistance Range 阻值范围	Resistance Tolerance 阻值公差	Operating Voltage 工作电压
50Ω~1MΩ	±5%	50V

### Electrical Characteristics- Capacitor (电容特性)

Capacitance Dielectric 电容介质	Capacitance Range 电容范围	Capacitance Tolerance 电容公差	Capacitance Voltage 电容电压
NPO	39pF~270pF	±10%	50V
X7R	>270pF~0.1μF	±20%	

### Circuit Structure (电路结构)

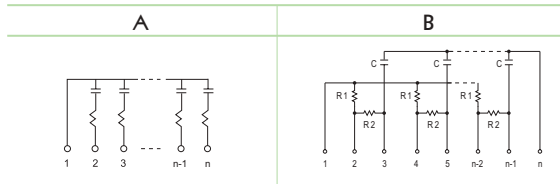

\* Custom Design Circuit could be available on a case to case basis  
(可提供客户特殊要求之线路产品)

### Marking (Single Value) [标示 (单一值)]

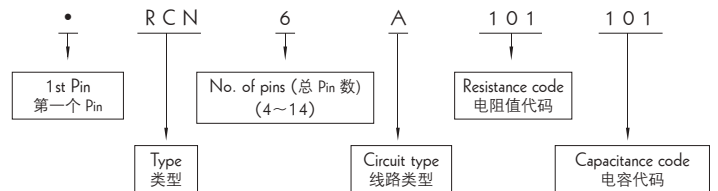

### Dimension (尺寸) (mm):

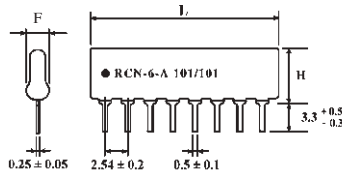

"•" indicate the 1st pin (表示第一脚位置)

Type 类型	H (mm)	F (mm)	L	
RCH	7.62 Max.	3.81 Max.	4 PIN: 10.2mm	10 PIN: 25.4mm
RCN	8.89 Max.	3.81 Max.	5 PIN: 12.7mm	11 PIN: 28.0mm
			6 PIN: 15.3mm	12 PIN: 30.5mm
			7 PIN: 17.8mm	13 PIN: 33.1mm
			8 PIN: 20.4mm	14 PIN: 35.6mm
			9 PIN: 22.9mm	

### Ordering Procedure (Example: RCN A 6PIN 100Ω/100pF B/B)

订购方式 (例如: RCN A 6PIN 100Ω/100pF B/B)

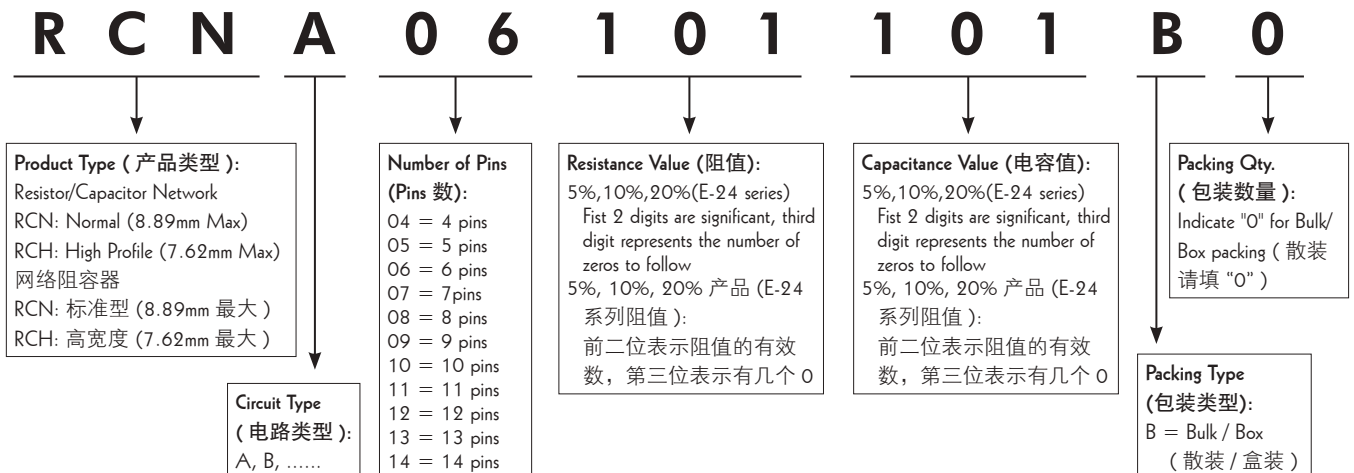

**Feature (特性)**

- Integrates capacitor function if one package 集成电容器作用
- Design reduces termination noise 静音设计
- Reduced insertion time 减少插件时间, 提高效率
- Popular standard capacitance values available 通用标准电容值
- Isolated, bussed and dual-bussed circuits available 隔离的总线和双总线电路

**Application (应用)**

- Microwave ovens 微波炉
- Color TV 电视
- Radio 收音机

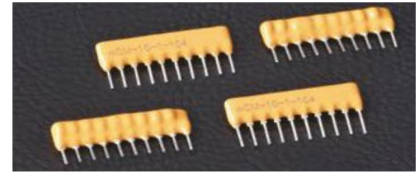

**Electrical Characteristics- Capacitor (电容特性)**

Capacitance Dielectric 电容介质	Capacitance Range 电容范围	Capacitance Tolerance 电容公差	Capacitance Voltage 电容电压
NPO	39pF~270pF	±10%	50V
X7R	>270pF~0.1μF	±20%	

**Dimension (尺寸) (mm):**

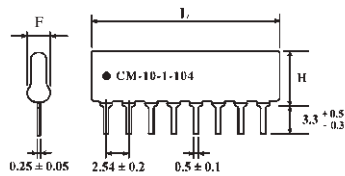

"•" indicate the 1st pin (示第一脚位置)

**Dimension of L (Max.) (L 的最大尺寸)**

Type 类型	H (mm)	F (mm)
CNM	6.35	3.81
	Max. 最大	Max. 最大
CNH	7.62	3.81
	Max. 最大	Max. 最大

4 PIN : 10.2mm	10 PIN : 25.4mm
5 PIN : 12.7mm	11 PIN : 28.0mm
6 PIN : 15.3mm	12 PIN : 30.5mm
7 PIN : 17.8mm	13 PIN : 33.1mm
8 PIN : 20.4mm	14 PIN : 35.6mm
9 PIN : 22.9mm	

**Marking (Single Value) [标示 (单个阻值)]**

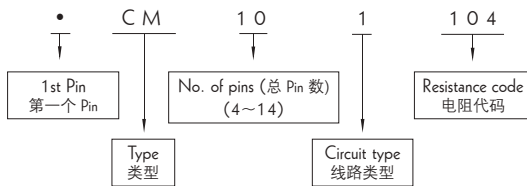

**Circuit Structure (电路结构)**

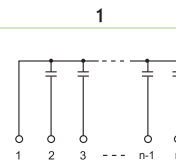

\* Custom Design Circuit could be available on a case to case basis (可提供客户特殊要求之线路产品)

**Ordering Procedure (Example: CNM 1 10PIN 0.1μF B/B)**

订购方式 (例如: CNM 1 10PIN 0.1μF B/B)

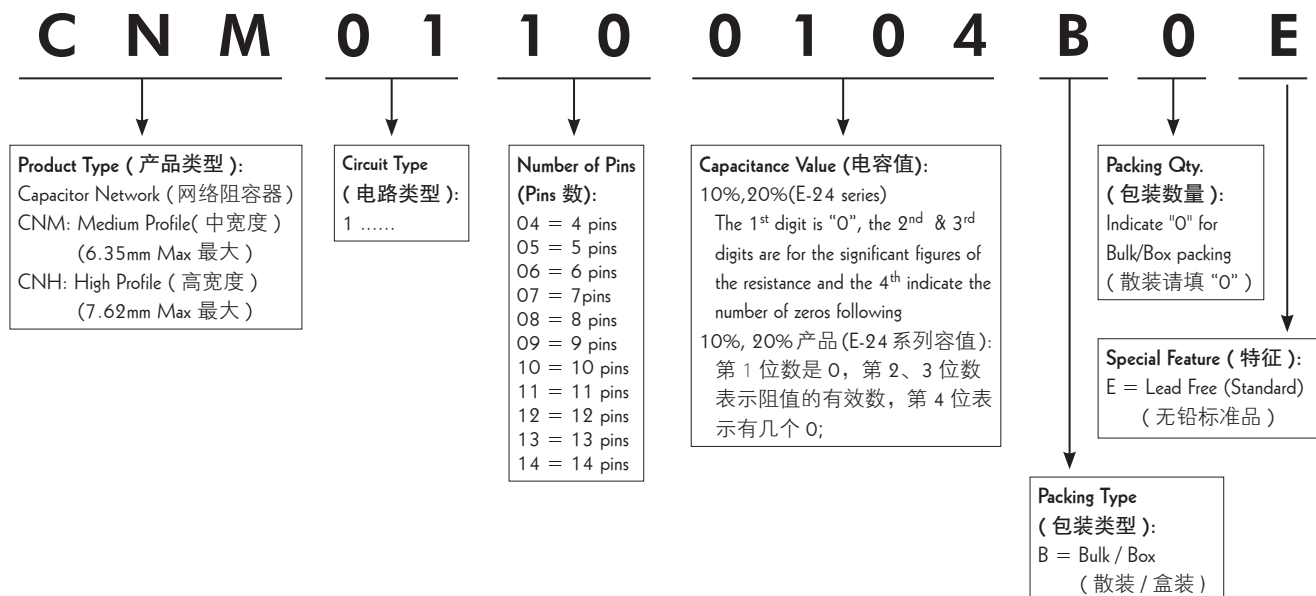

### Feature (特性)

- Small size, Light weight 小尺寸, 重量轻
- High stability, Reliability 高稳定性, 高可靠性
- Max working voltage 10KV 最大工作电压可达10KV
- Used in microwave ovens, induction cooker, High Voltage Power Supply, Laser light control circuit and other applications  
用于微波炉, 电磁炉, 高压电源, 激光控制电路和其他应用程序



### Dimension (尺寸) (mm)

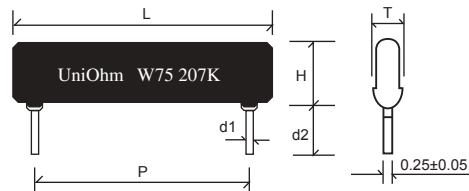

### Derating Curve & Specification (降功率曲线和性能)

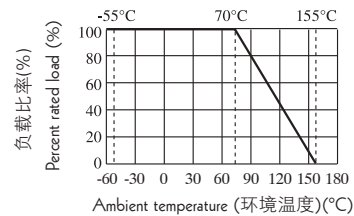

Part No. 料号	Type 类型	Power rating 功率 70°C	Dimension (尺寸) (mm)						Max Working Voltage 最大工作电压	Dielectric Withstanding Voltage 绝缘耐压	Resistance Range 阻值范围
			P±0.5	L(max) L最大	d1±0.1	d2 <sup>+0.5</sup> <sub>-0.2</sub>	H(max) H最大	T(max) T最大			
HFR0W2	HFR-50	0.5W	17.8	20.4	0.5	3.5	5.08	2.5	5KV	500V	1M~1GΩ
HFR007	HFR-75	0.75W	22.9	25.4	0.5	3.5	5.08	2.5	10KV	500V	1M~1GΩ
HFR01W	HFR-100	1W	27.9	30.5	0.5	3.5	5.08	2.5	10KV	500V	1M~1GΩ

### Performance Specification (性能)

Temperature coefficient 温度系数	±200PPM/°C	Humidity (steady State) 恒定湿热	ΔR/R±(1.0%+0.1 Ω)
Terminal strength 端子强度	ΔR/R≤±(1%+0.1Ω)	Load life in humidity 湿度寿命	ΔR/R±(3.0%+0.1Ω)
Soldering heat 耐焊接热	ΔR/R±(1%+0.1 Ω)	Load life 负载寿命	ΔR/R±(3.0%+0.1Ω)
Solderability 可焊性	Min.95% coverage (最少 95% 覆盖率)	Insulation resistance 绝缘电阻	≥10,000MΩ
Temperature cycling 温度循环	ΔR/R±(1%+0.1 Ω)	Thermal shock 热冲击	ΔR/R±(1%+0.1Ω)

### Ordering Procedure (Example: HFR 0.75W 10% 10M B/B)

订购方式 (例如: HFR 0.75W 10% 10M B/B)

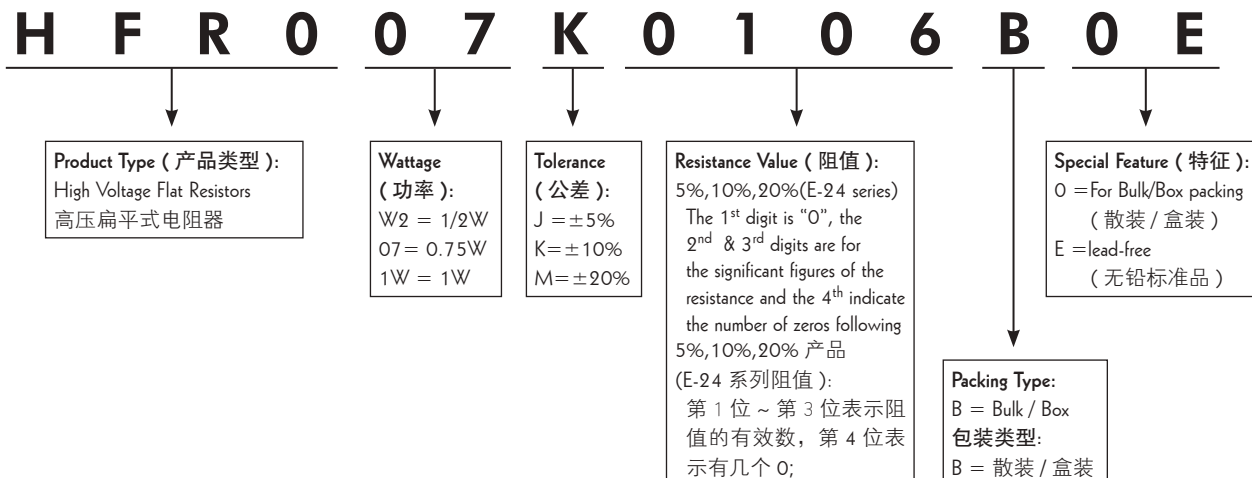

Feature (特性)

- High quality performance 高品质
- Great economy 低成本
- Flame retardant type available 可提供不燃性涂装
- Automatically insertable 适用自动化插件

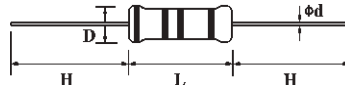

Part No. 料号	Type 类型	Power Rating 功率 70°C	Dimension (尺寸) (mm)				Max. Working Voltage 最大工作电压	Max. Overload Voltage 最大过负荷电压	Dielectric Withstanding Voltage 绝缘耐压	Resistance Range 阻值范围
			D	L	d±0.05	H ± 3				
Normal Size (正常尺寸)										
CFROW8	CFR-12	1/8W	1.9±0.3	3.3±0.3	0.45	28	200V	400V	400V	1Ω ~ 1MΩ
CFROW4	CFR-25	1/4W	2.2±0.3	6.5±1.0	0.54	28	250V	500V	500V	1Ω ~ 10MΩ
CFROW2	CFR-50	1/2W	3.0±0.5	9.5±1.0	0.54	28	350V	700V	700V	1Ω ~ 10MΩ
CFR01W	CFR-100	1W	5.0±0.5	15.5±1.0	0.70	28	500V	1000V	1000V	1Ω ~ 10MΩ
CFR02W	CFR-200	2W	6.0±0.5	17.5±1.0	0.75	28	500V	1000V	1000V	1Ω ~ 10MΩ
Small Size & Extra Small Size (小型及超小型尺寸)										
CFR0S4	CFR-25-S	1/4W	1.9±0.3	3.3±0.3	0.45	28	200V	400V	400V	1Ω ~ 1MΩ
CFR0U2	CFR-50-SS	1/2W	2.2±0.5	6.5±1.0	0.54	28	250V	500V	250V	1Ω ~ 10MΩ
CFR0S2	CFR-50-S	1/2W	3.0±0.5	9.0±1.0	0.54	28	350V	700V	700V	1Ω ~ 10MΩ
CFR01S	CFR-100-S	1W	4.0±0.5	11.5±1.0	0.65	28	500V	1000V	1000V	1Ω ~ 10MΩ
CFR02S	CFR-200-S	2W	5.0±0.5	15.5±1.0	0.70	28	500V	1000V	1000V	1Ω ~ 10MΩ
CFR03S	CFR-300-S	3W	6.0±0.5	17.5±1.0	0.75	28	500V	1000V	1000V	1Ω ~ 10MΩ

- Standard E-24 series values in ±5%, ±10% & ±20% tolerance  
标准E-24系列公差为±5%、±10% & ±20%阻值
- Standard Beige base color, Light Brown color for CFR01S, CFR02S & CFR03S  
正常尺寸产品涂标准米黄色底漆, CFR01S, CFR02S & CFR03S涂浅棕色底漆
- Standard Grayish-green base color (Non-Flammable coating) for CFR0U2 (CFR-50-SS)  
CFR0U2 (CFR-50-SS)涂标准灰绿色(不燃性)底漆
- For any special inquiry such as too Low or too High ohmic values is available on a case to case basis  
特殊要求, 含超高、超低阻值也可特别安排生产

Derating Curve (降功率曲线)

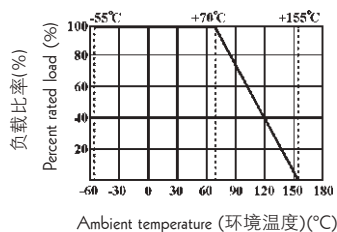

### Performance Specification (性能)

<b>Temperature coefficient</b> 温度系数	±300PPM/°C for ≤10Ω; ±450PPM/°C for 11Ω ~ 99KΩ; 0 ~ -700PPM/°C for 100KΩ ~ 1MΩ; 0 ~ -1500PPM/°C for 1.1MΩ ~ 10MΩ.
<b>Short-time overload</b> 短时间过负荷	ΔR/R ≤ ±(1%+0.05Ω), with no evidence of mechanical damage (无可见机械损伤)
<b>Insulation resistance</b> 绝缘电阻	≥10,000MΩ
<b>Dielectric withstanding voltage</b> 绝缘耐压	No evidence of flashover, mechanical damage, arcing or insulation breakdown 无击穿、飞弧及可见机械损伤
<b>Terminal strength</b> 端子强度	No evidence of mechanical damage (无可见机械损伤)
<b>Soldering heat</b> 耐焊接热	ΔR/R ≤ ±(1%+0.05Ω), with no evidence of mechanical damage (无可见机械损伤)
<b>Solderability</b> 可焊性	Min. 95% coverage (最少 95% 覆盖率)
<b>Resistance to solvent</b> 耐溶剂	No deterioration of protective coating and markings (包封层, 色码完整)
<b>Temperature cycling</b> 温度循环	ΔR/R ≤ ±(1%+0.05Ω), with no evidence of mechanical damage (无可见机械损伤)
<b>Load life in humidity</b> 湿度寿命	Normal type (正常尺寸): ΔR/R ± 3% for <100KΩ, ±5% for ≥100KΩ; Flame retardant type (不燃性): ΔR/R ± 5% for <100KΩ, ±10% for ≥100KΩ
<b>Load life</b> 负载寿命	Normal type (正常尺寸): ΔR/R ± 2% for <56KΩ, ±3% for ≥56KΩ; Flame retardant type (不燃性): ΔR/R ± 5% for <100KΩ, ±10% for ≥100KΩ

### Ordering Procedure (Example: CFR 1/4WS Flame Retardant type 5% 10KΩ T/B-5000)

订购方式 (例如: CFR 1/4WS 不燃性 5% 10KΩ T/B-5000)

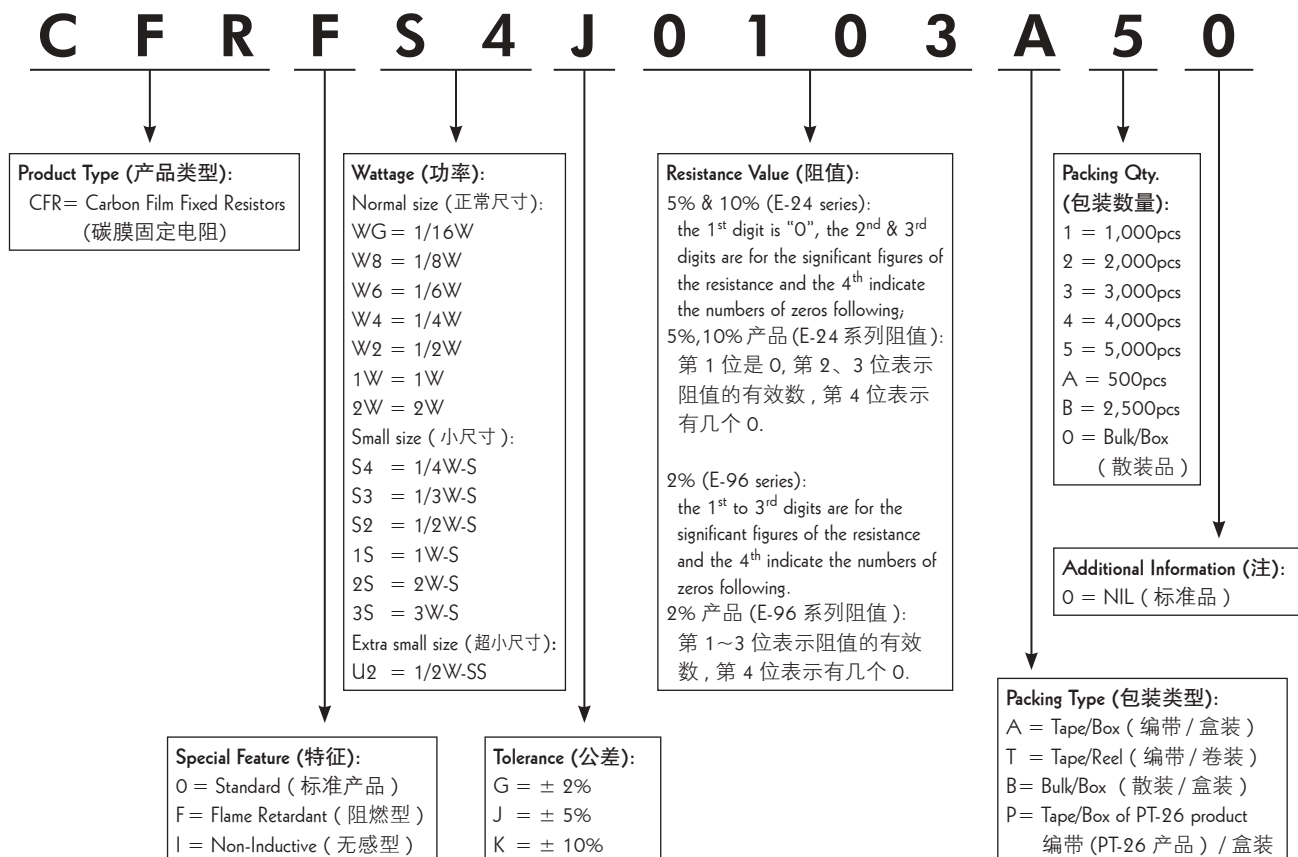

Feature (特性)

- EIA standard color coding. EIA标准色码
- Flame retardant type available 可供不燃性涂装
- Low noise & voltage coefficient 噪声低, 电压系数小
- Low temperature coefficient range 温度系数低
- Multiple epoxy coating on vacuum-deposited metal film provides superior moisture protection 真空溅射金属皮膜涂多层环氧树脂, 防水性效果好
- Nichrome resistive element provides stable performance in various environments 镍基金属膜层的采用使各项性能更加稳定

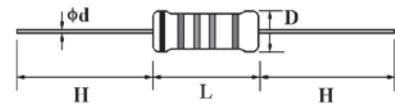
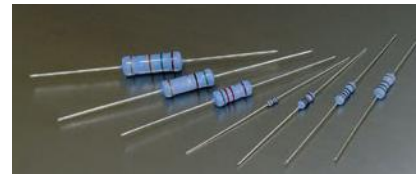

Part No. 料号	Type 类型	Power Rating 功率 70°C	Dimension (尺寸) (mm)			
			D	L	d ± 0.05	H ± 3
<b>Normal Size (正常尺寸)</b>						
MFROW8	MF-12	1/8W	1.9±0.3	3.3±0.3	0.45	28
MFROW4	MF-25	1/4W	2.2±0.3	6.5±1.0	0.54	28
MFROW2	MF-50	1/2W	3.0±0.5	9.5±1.0	0.54	28
MFR01W	MF-100	1W	4.5±0.5	11.5±1.0	0.65	28
MFR02W	MF-200	2W	5.0±0.5	15.5±1.0	0.70	28
MFR03W	MF-300	3W	6.0±0.5	17.5±1.0	0.75	28
<b>Small Size &amp; Extra Small Size (小型及超小型尺寸)</b>						
MFR0S4	MF-25-S	1/4W	1.9±0.5	3.3±0.3	0.45	28
MFR004	MF-40-SS	0.4W	1.9±0.5	3.3±0.3	0.45	28
MFR0U2	MF-50-SS	1/2W	2.2±0.5	6.5±0.5	0.54	28
MFR0S2	MF-50-S	1/2W	2.7±0.5	9.0±1.0	0.54	28
MFR006	MF-60-S	0.6W	2.2±0.5	6.5±1.0	0.54	28
MFR01S	MF-100-S	1WS	3.5±0.5	9.5±1.0	0.65	28
MFR02S	MF-200-S	2WS	4.0±0.5	11.5±1.0	0.65	28
MFR03S	MF-300-S	3WS	5.0±0.5	15.5±1.0	0.7	28

Derating Curve (降功率曲线)

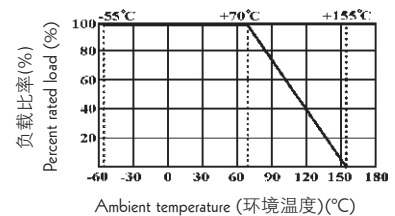

Standard Non-flammable coating for Small size type (except MF-50-S). [小尺寸标准不燃性涂装 (MF-50-S除外)]

Part No. 料号	Type 类型	Dielectric Withstanding Voltage 绝缘耐压	Max. Working Voltage 最大工作电压	Max. Overload Voltage 最大过负荷电压	Standard Order 标准品			Special Order 特殊订购品		
					Tolerance 公差	TCR 温度系数	Resistance Range 阻值范围	Tolerance 公差	TCR 温度系数	Resistance Range 阻值范围
MFROW8	MF-12	400V	200V	400V	±1%	± 50	10Ω-1MΩ	± 0.25%	± 15	51.1Ω ~ 200KΩ
MFR0S4	MF-25-S	200V	200V	400V	±2%	± 100	10Ω-1MΩ	± 0.5%	± 25	51.1Ω ~ 511KΩ
MFR004	MF-40-SS				±5%	± 200	1Ω-1MΩ	± 0.5%	± 50	51.1Ω ~ 511KΩ
MFROW4	MF-25	500V	250V	500V	±1%	± 50	10Ω-1MΩ	± 0.1%	± 15	10Ω ~ 1MΩ
MFR0U2	MF-50-SS	250V	250V	500V	±2%	± 100	1Ω-1MΩ	± 0.25%	± 25	10Ω ~ 1MΩ
MFR006	MF-60-S				±5%	± 200	1Ω-1MΩ	± 0.5%	± 50	10Ω ~ 1MΩ
MFR0S2	MF-50-S	700V	350V	700V	±1%	± 50	10Ω-1MΩ	± 0.1%	± 15	100Ω ~ 330KΩ
MFROW2	MF-50				±2%	± 100	10Ω-1MΩ	± 0.25%	± 25	51.1Ω ~ 511KΩ
MFR01W	MF-100	1000V	500V	1000V	±5%	± 200	1Ω-1MΩ	± 0.5%	± 50	10Ω ~ 1MΩ
MFR02W	MF-200				±1%	± 50	51.1Ω-1MΩ	± 0.1%	± 15	100Ω ~ 330KΩ
MFR03W	MF-300	±2%	± 100	51.1Ω-1MΩ	± 0.25%	± 25	51.1Ω ~ 511KΩ			
MFR01S	MF-100-S	350V	350V	700V	±1%	± 50	1Ω-1MΩ	± 0.1%	± 15	100Ω ~ 330KΩ
MFR02S	MF-200-S	350V	500V	1000V	±2%	± 100		± 0.25%	± 25	51.1Ω ~ 511KΩ
MFR03S	MF-300-S	±5%	± 200	± 0.5%	± 50	51.1Ω ~ 1MΩ				

### Performance Specification (性能)

Temperature coefficient	温度系数	according to page 52 (参考第 52 页)
Short-time overload	短时间过负荷	$\Delta R/R \leq \pm(0.5\%+0.05\Omega)$ , with no evidence of mechanical damage (无可见机械损伤)
Dielectric withstanding voltage	绝缘耐压	With no evidence of flashover, mechanical damage, arcing or insulation breakdown 无击穿、飞弧及可见机械损伤
Pulse overload	脉冲过负荷	$\Delta R/R \leq \pm(1\%+0.05\Omega)$ , with no evidence of mechanical damage (无可见机械损伤)
Terminal strength	端子强度	No evidence of mechanical damage (无可见机械损伤)
Soldering heat	耐焊接热	$\Delta R/R \leq \pm(1\%+0.05\Omega)$ , with no evidence of mechanical damage (无可见机械损伤)
Solderability	可焊性	Min. 95% coverage (最少 95% 覆盖率)
Resistance to solvent	耐溶剂	No deterioration of protective coating and marking (包封层, 色码完整)
Temperature cycling	温度循环	$\Delta R/R \leq \pm(1\%+0.05\Omega)$ , with no evidence of mechanical damage (无可见机械损伤)
Load life in humidity	湿度寿命	Normal type (普通型): $\Delta R/R \leq \pm 1.5\%$ ; Flame retardant type (阻燃型): $\Delta R/R \leq \pm 5\%$ .
Load life	负载寿命	Normal type (普通型): $\Delta R/R \leq \pm 1.5\%$ ; Flame retardant type (阻燃型): $\Delta R/R \leq \pm 5\%$ .

### Current Noise Level (电流噪声水平)

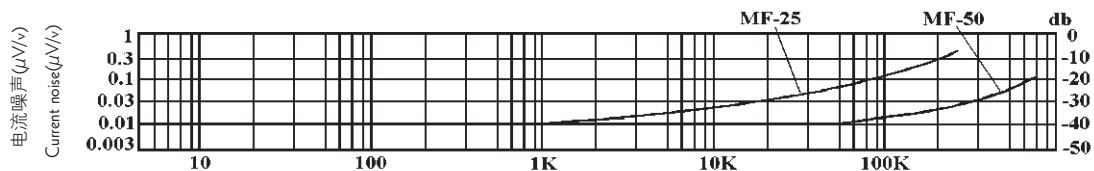

### Ordering Procedure (Example: MFR 1/8W 1% 50PPM 47.5K $\Omega$ T/R-5000)

订购方式 (例如: MFR 1/8W 1% 50PPM 47.5K $\Omega$  T/R-5000)

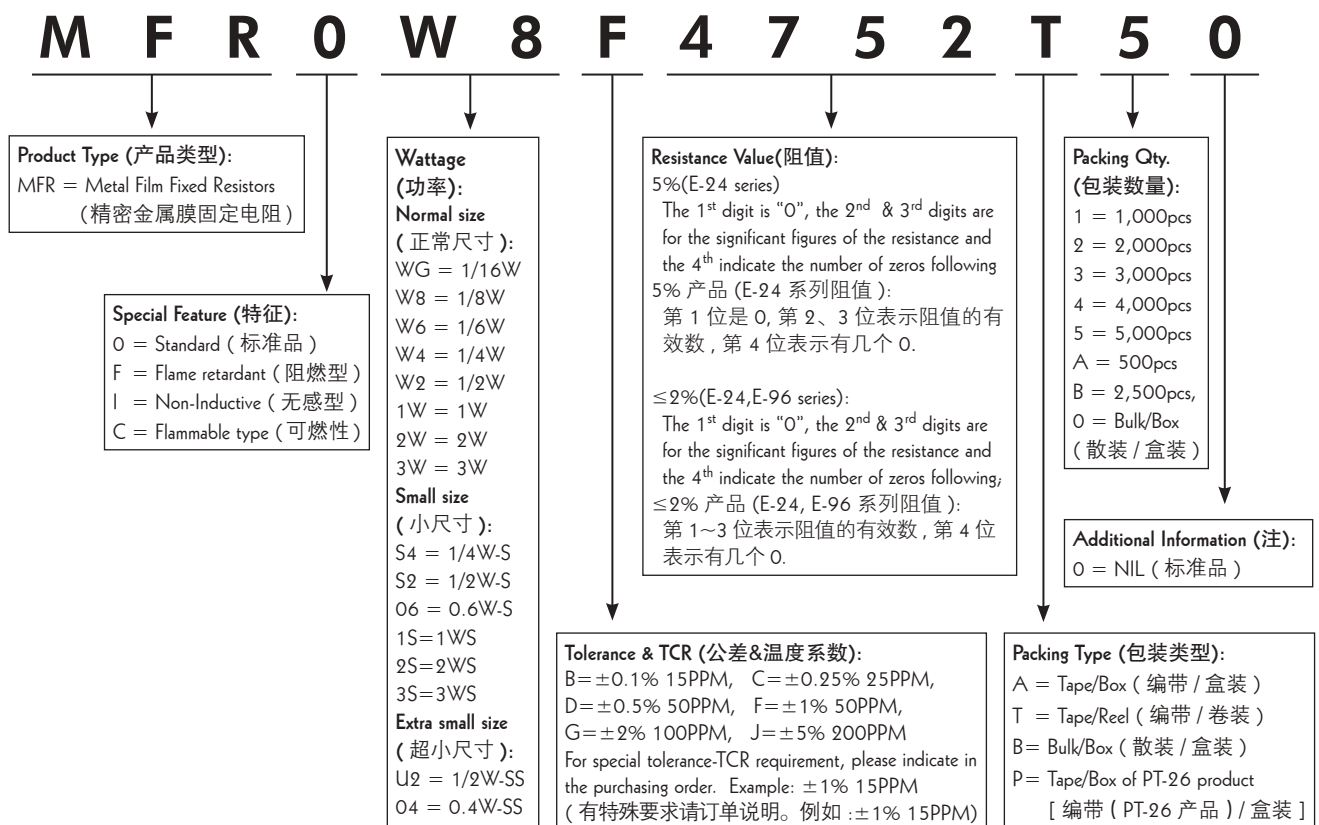

Feature (特性)

- High power in small body size 小体积，大功率
- Excellent flame Retardant coating 优异的阻燃封装
- Non-Inductive type available 可提供无感型



Dimension (尺寸) (mm)

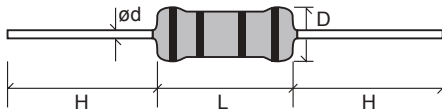

Derating Curve & Specification (降功率曲线及性能)

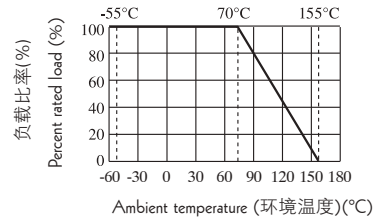

Part No. 料号	Type 类型	Power rating 功率 70°C	Dimension (尺寸) (mm)				Max Working Voltage 最大工作电压	Dielectric Withstanding Voltage 绝缘耐压	Max Overload Voltage 最大过负荷电压	Resistance Range 阻值范围	Tolerance 公差
			D±0.5	L±1	d±0.05	H±3					
CPR0W2	CPR-50	1/2W	2.2	6.5	0.55	28	300V	500V	700V	1Ω~10M	
CPR01W	CPR-100	1W	3.5	9.5	0.55	28	500V	700V	1000V	1Ω~10M	±2%, ±5%
CPR02W	CPR-200	2W	4.5	11	0.65	28	500V	1000V	1000V	1Ω~10M	

Performance Specification (性能)

Temperature coefficient 温度系数	≤10Ω: ±300PPM 11Ω~99K: ±450PPM 100K~1M: 0~-700PPM 1.1M~10M: 0~-1500PPM	Temperature cycling 温度循环	ΔR/R±(1%+0.05 Ω)
Short-time overload 短时间过负荷	ΔR/R±(0.75%+0.05 Ω)	Humidity (steady State) 恒定湿热	ΔR/R±(2%+0.05 Ω)
Terminal strength 端子强度	No evidence of mechanical damage 无可见机械损伤	Load life in humidity 湿度寿命	1/2W 1W 2W: ΔR/R±(3.0%+0.05Ω) 3W: ΔR/R±(5.0%+0.05Ω)
Soldering heat 耐焊接热	ΔR/R±(1%+0.05 Ω)	Load life 负载寿命	1/2W 1W 2W: ΔR/R±(3.0%+0.05Ω) 3W: ΔR/R±(5.0%+0.05Ω)
Solderability 可焊性	Min.95% coverage 最少 95% 覆盖率	Insulation resistance 绝缘电阻	≥1,000MΩ
		Resistance to solvent 耐溶剂	No deterioration of protective coating and markings 封装层，色码完整

Ordering Procedure (Example: CPR 2W 5% 10K T/B)

订购方式 (例如: CPR 2W 5% 10K T/B)

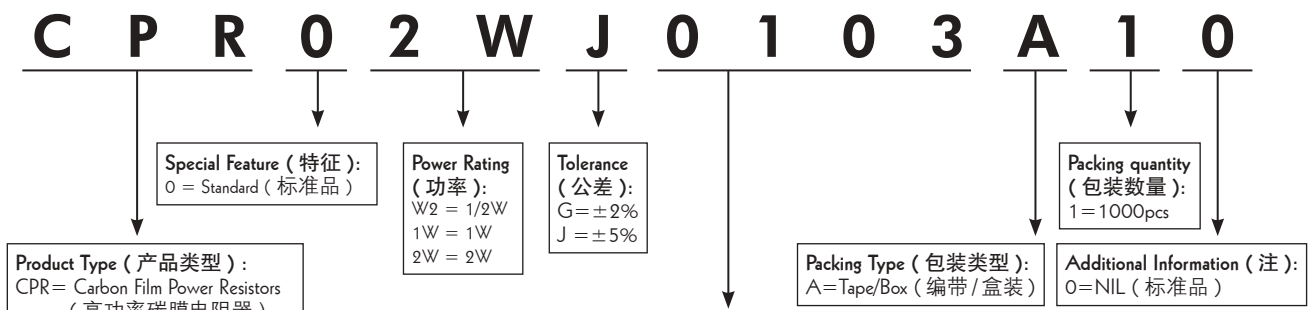

**Resistance Value (阻值):**  
**5% (E-24 series):** The 1<sup>st</sup> digit is "0", the 2<sup>nd</sup> & 3<sup>rd</sup> digits are for the significant figures of the resistance and the 4<sup>th</sup> indicate the number of zeros following  
 5% 产品 (E-24 系列阻值): 第 1 位是 0, 第 2、3 位表示阻值的有效数, 第 4 位表示有几个 0.  
**2% (E-24 series):** The 1<sup>st</sup> digit is "0", the 2<sup>nd</sup> & 3<sup>rd</sup> digits are for the significant figures of the resistance and the 4<sup>th</sup> indicate the number of zeros following;  
 2% 产品 (E-24 系列阻值): 第 1-3 位数表示阻值的有效数, 第 4 位数表示有几个 0



### Feature (特性)

- High power in small body size 体积小功率高
- Excellent flame Retardant coating 优异不燃性涂装
- High stability even in bad environment 恶劣环境下同样稳定工作
- Match the Safety requirement 满足安全标准要求



### Derating Curve (降功率曲线)

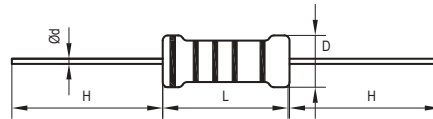
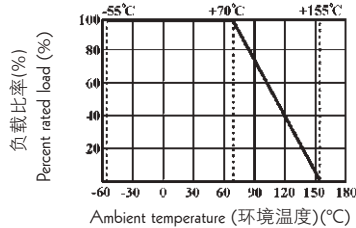

### Specification (性能)

Part No. 料号	Type 类型	Power rating 功率 70°C	Dimension (尺寸)(mm)				Max. Working Voltage 最大工作电压	Dielectric Withstanding Voltage 绝缘耐压	Max. Overload Voltage 最大过负荷电压	Resistance Range 阻值范围
			D	L	d±0.05	H±3				
MPR01W	MPR-100	1W	2.2±0.5	6.5±1.0	0.75	28	500V	500V	600V	10Ω ~ 10M
MPR02W	MPR-200	2W	3.5±0.5	9.5±1.0	0.75	28	500V	500V	1000V	10Ω ~ 10M
MPR03W	MPR-300	3W	5.0±0.5	15.5±1.0	0.75	28	750V	500V	1000V	10Ω ~ 1M

### Performance Specifications (性能)

Temperature coefficient	温度系数	1W: ±200PPM/°C(±1%), ±250PPM/°C(±5%) 2W: ±200PPM/°C(±2%), ±250PPM/°C(±5%) 3W: ±50PPM/°C(±1%, ±5%)
Short-time overload	短时间过负荷	ΔR/R ≤ ±(2%+0.05Ω), with no evidence of mechanical damage (无可见机械损伤)
Terminal Strength	端子强度	with no evidence of mechanical damage (无可见机械损伤)
Soldering heat	耐焊接热	ΔR/R ≤ ±(1%+0.05Ω), with no evidence of mechanical damage (无可见机械损伤)
Solderability	可焊性	Min. 95% coverage (最少 95% 覆盖率)
Temperature cycling	温度循环	ΔR/R ≤ ±(2%+0.05Ω), with no evidence of mechanical damage (无可见机械损伤)
Load life in humidity	湿度寿命	ΔR/R ≤ ±(5%+0.05Ω), with no evidence of mechanical damage (无可见机械损伤)
Load life	负载寿命	1W, 3W: ΔR/R ≤ ±(3%+0.05Ω), with no evidence of mechanical damage (无可见机械损伤) 2W: ΔR/R ≤ ±(5%+0.06Ω), with no evidence of mechanical damage (无可见机械损伤)
Flame retardant	阻燃	Resistor insulation is self-extinguishing within 10 seconds after externally applied flame is removed 火焰移开后 10 秒内, 电阻自动绝燃, 无可见火焰

### Ordering Procedure (Example: MPR 1W 5% 100Ω T/B-5000)

订购方式 (例如: MPR 1W 5% 100Ω T/B-5000)

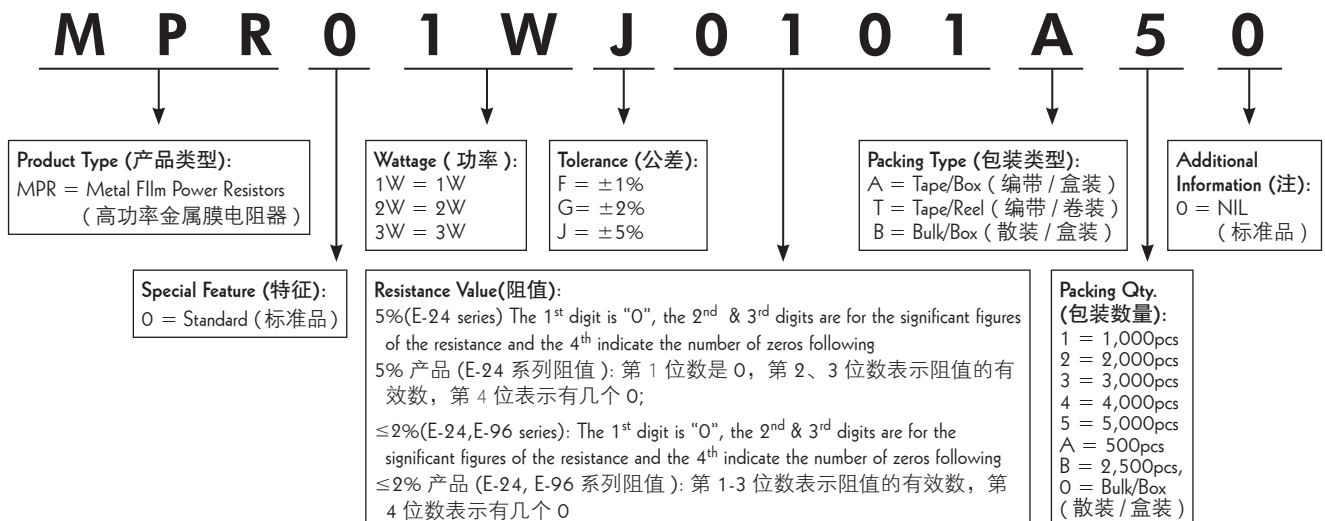

Feature (特性)

- Excellent flame retardant coating 优异不燃性涂装
- High Stability even in bad environment 恶劣环境下同样稳定工作
- High purity ceramic core 高纯度瓷芯
- Meet EIA-RC2655A requirements 满足EIA-RC2655A标准要求
- High safety standard 满足安全性标准要求



Derating Curve (降功率曲线)

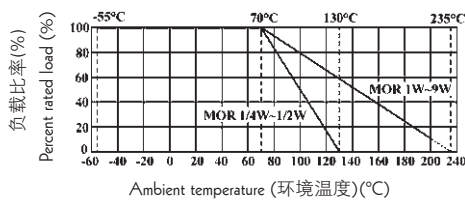

Heat Rise Chart (表面温升)

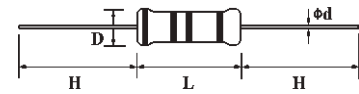
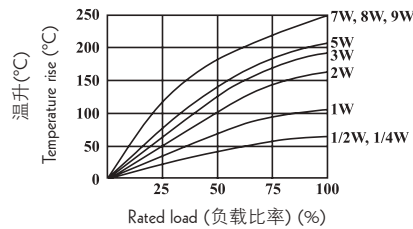

Specification (性能)

Part No. 料号	Type 类型	Power Rating 功率 70°C	Dimension (尺寸) (mm)				Max. Working Voltage 最大工作电压	Max. Overload Voltage 最大过负荷电压	Dielectric Withstanding Voltage 绝缘耐压	Resistance Range 阻值范围
			D	L	d±0.05	H±3				
Normal Size (正常尺寸)										
MOR0W4	MOR-25	1/4W	2.2±0.5	6.5±1.0	0.54	28	250V	400V	250V	0.1Ω ~ 470KΩ
MOR0W2	MOR-50	1/2W	3.0±0.5	9.5±1.0	0.54	28	250V	400V	250V	0.1Ω ~ 560KΩ
MOR01W	MOR-100	1W	4.0±0.5	11.5±1.0	0.65	28	350V	600V	350V	0.1Ω ~ 560KΩ
MOR02W	MOR-200	2W	5.0±0.5	15.5±1.0	0.70	28	350V	600V	350V	0.1Ω ~ 560KΩ
MOR03W	MOR-300	3W	6.0±0.5	17.5±1.0	0.75	28	500V	800V	500V	0.1Ω ~ 560KΩ
MOR05W	MOR-500	5W	8.0±0.5	24.5±1.0	0.75	38	750V	1000V	750V	0.1Ω ~ 680KΩ
MOR07W	MOR-700	7W	8.0±0.5	29.5±1.0	0.75	38	750V	1000V	750V	20Ω ~ 150KΩ
MOR08W	MOR-800	8W	8.0±0.5	39.5±1.0	0.75	38	750V	1000V	750V	30Ω ~ 200KΩ
MOR09W	MOR-900	9W	8.0±0.5	52.5±1.0	0.75	38	750V	1000V	750V	50Ω ~ 200KΩ
Small Size & Extra Small Size (小型及超小型尺寸)										
MOR0S2	MOR-50-S	1/2W	2.2±0.5	6.5±1.0	0.54	28	250V	400V	250V	0.1Ω ~ 470KΩ
MOR01S	MOR-100-S	1W	3.5±0.5	9.5±1.0	0.65	28	350V	600V	350V	0.1Ω ~ 560KΩ
MOR02S	MOR-200-S	2W	4.5±0.5	11.5±1.0	0.65	28	350V	600V	350V	0.1Ω ~ 560KΩ
MOR03S	MOR-300-S	3W	5.0±0.5	15.5±1.0	0.70	28	350V	600V	350V	0.1Ω ~ 560KΩ
MOR05U	MOR-500-SS	5W	6.0±0.5	17.5±1.0	0.75	28	500V	800V	500V	0.1Ω ~ 560KΩ
MOR05S	MOR-500-S	5W	8.0±0.5	24.5±1.0	0.75	38	500V	800V	500V	0.1Ω ~ 680KΩ

- Standard E-24 series value in ± 5% tolerance (标准E-24系列 ± 5%公差阻值)
- Standard Gray base color for Normal Size product, Blue color for Small Size product (正常尺寸产品涂灰色底漆, 小尺寸产品涂海蓝色底漆)
- Standard Non-Flammable coating (标准不燃性涂装)
- Non-Inductive type available on a case to case basis (无感, 可特别生产)

### Performance Specification

<b>Temperature coefficient</b> 温度系数	1/4W, 1/2WS: $\leq 100K\Omega: \pm 350PPM/^{\circ}C$ / $100K\Omega < R \leq 470K\Omega: 0 \sim -700PPM/^{\circ}C$ 1/2W, 1WS: $\leq 120K\Omega: \pm 350PPM/^{\circ}C$ / $120K\Omega < R \leq 560K\Omega: 0 \sim -700PPM/^{\circ}C$ 1W, 2W, 2WS, 3W, 3WS, 5WSS: $\leq 150K\Omega: \pm 350PPM/^{\circ}C$ / $150K\Omega < R \leq 560K\Omega: 0 \sim -700PPM/^{\circ}C$ 5W, 5WS: $\leq 180K\Omega: \pm 350PPM/^{\circ}C$ / $180K\Omega < R \leq 680K\Omega: 0 \sim -700PPM/^{\circ}C$ 7W, 8W, 9W: $\pm 350PPM/^{\circ}C$
<b>Short-time overload</b> 短时间过负荷	Normal size (正常尺寸), $\Delta R/R \leq \pm(1\%+0.05\Omega)$ , with no evidence of mechanical damage (无可见机械损伤) Small size (小尺寸), $\Delta R/R \leq \pm(2\%+0.05\Omega)$ , with no evidence of mechanical damage (无可见机械损伤)
<b>Dielectric withstanding voltage</b> 绝缘耐压	No evidence of flashover, mechanical damage, arcing or insulation breakdown (无击穿、飞弧及可见机械损伤)
<b>Pulse overload</b> 脉冲过负荷	Normal size (正常尺寸), $\Delta R/R \leq \pm(2\%+0.05\Omega)$ , with no evidence of mechanical damage (无可见机械损伤) Small size (小尺寸), $\Delta R/R \leq \pm(5\%+0.05\Omega)$ , with no evidence of mechanical damage (无可见机械损伤)
<b>Terminal Strength</b> 端子强度	No evidence of mechanical damage (无可见机械损伤)
<b>Soldering heat</b> 耐焊接热	$\Delta R/R \leq \pm(1\%+0.05\Omega)$ with no evidence of mechanical damage (无可见机械损伤)
<b>Solderability</b> 可焊性	Min. 95% coverage (最少 95% 覆盖率)
<b>Resistance to solvent</b> 耐溶剂	No deterioration of protective coating and markings (包封层, 色码完整)
<b>Temperature cycling</b> 温度循环	$\Delta R/R \leq \pm(2\%+0.05\Omega)$ with no evidence of mechanical damage (无可见机械损伤)
<b>Humidity (Steady State)</b> 恒定湿热	$\Delta R/R \leq \pm(2\%+0.05\Omega)$ with no evidence of mechanical damage (无可见机械损伤)
<b>Load life in humidity</b> 湿度寿命	$\Delta R/R: \leq \pm 5\%$ for $< 100K\Omega$ ; $\pm 10\%$ for $\geq 100K\Omega$ .
<b>Load life</b> 负载寿命	$\Delta R/R: \leq \pm 5\%$ for $< 100K\Omega$ ; $\pm 10\%$ for $\geq 100K\Omega$ .
<b>Flame retardant</b> 阻燃	Resistor insulation is self-extinguishing within 10 seconds after externally applied flame is removed (火焰移开后 10 秒内, 电阻自动绝燃, 无可见火焰)

### Ordering Procedure (Example: MOR 1W-S 5% 8.2K J/B-1000)

订购方式 (例如: MOR 1W-S 5% 8.2K J/B-1000)

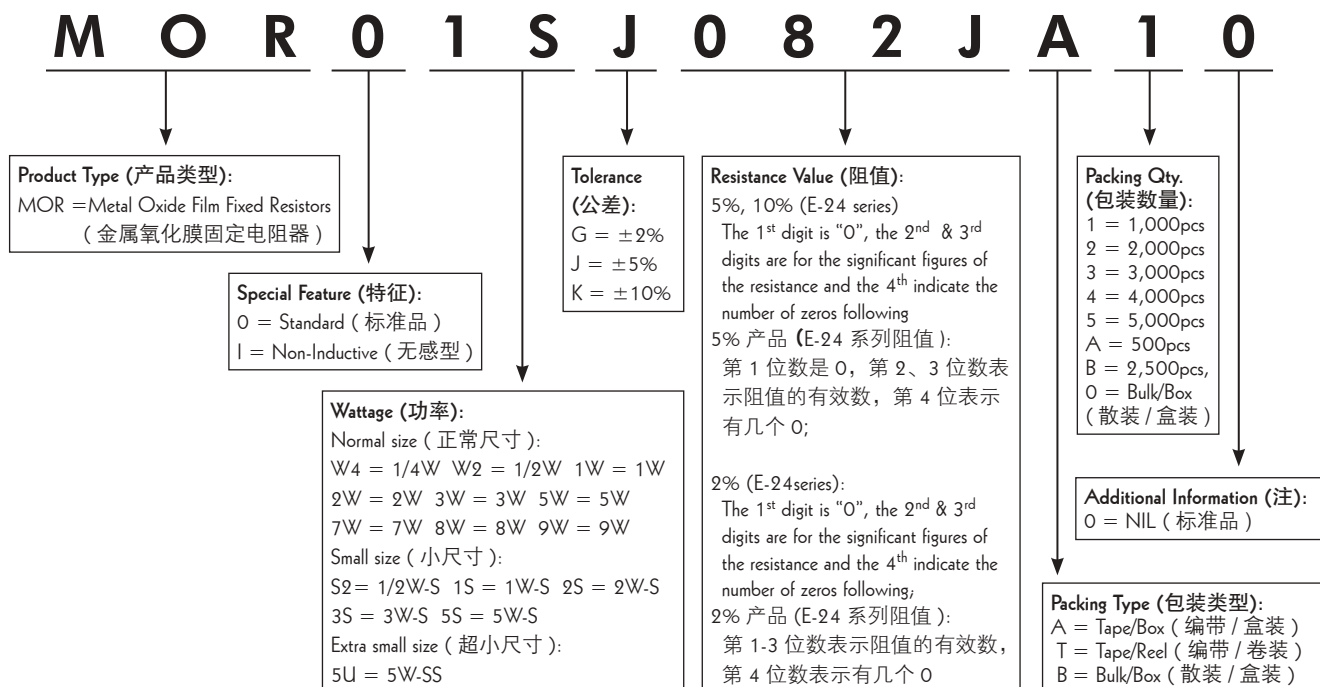

Feature (特性)

- Excellent flame retardant coating 优异不燃性涂装
- Too low or too high ohmic value can be supplied on a case to case basis  
超低或超高阻值都可特别提供
- Non-Inductive type available 可特别提供无感型产品

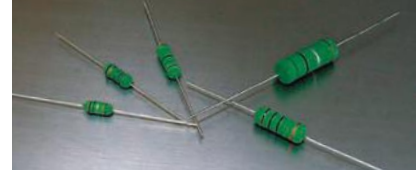

KNP Type (KNP型)



KNS Type (KNS型)

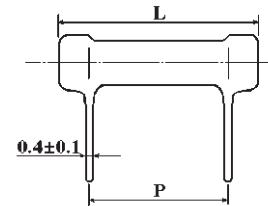
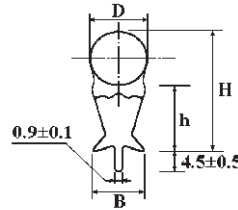

Part No. 料号	Type 类型	Power Rating 功率 70°C	Dimension (尺寸)(mm)						Resistance Range 阻值范围
			D ± 1.0	L ± 1.5	P ± 1	H ± 1	h ± 1	B ± 0.5	
KNS02W	KNS-200	2W	7.0	19.0	8	19	12	4.5	0.05Ω ~ 470Ω
KNS03W	KNS-300	3W	7.0	21.0	10	19	13	4.5	0.068Ω ~ 470Ω
KNS05W	KNS-500	5W	9.0	26.0	15	21.5	13	6.5	0.01Ω ~ 750Ω
KNS07W	KNS-700	7W	9.0	31.0	20	21.5	13	6.5	0.1Ω ~ 1.1KΩ
KNS08W	KNS-800	8W	9.0	41.0	30	21.5	13	6.5	0.2Ω ~ 2.2KΩ
KNS0AW	KNS-1000	10W	9.0	54.0	43	21.5	13	6.5	0.3Ω ~ 3.3KΩ

Part No. 料号	Type 类型	Power Rating 功率 70°C	Dimension (尺寸)(mm)				Resistance Range 阻值范围
			D ± 1	L ± 1	d ± 0.05	H ± 3	
<b>Normal Size (正常尺寸)</b>							
KNP0W2	KNP-50	1/2W	3.5	9.5	0.60	28	0.01Ω ~ 820Ω
KNP01W	KNP-100	1W	4.5	11.5	0.65	28	0.01Ω ~ 1.2KΩ
KNP02W	KNP-200	2W	5.5	15.5	0.70	28	0.01Ω ~ 3.0KΩ
KNP03W	KNP-300	3W	6.5	17.5	0.75	28	0.039Ω ~ 3.9KΩ
KNP05W	KNP-500	5W	8.5	24.5	0.75	38	0.082Ω ~ 5.6KΩ
KNP07W	KNP-700	7W	8.5	29.5	0.75	38	0.1Ω ~ 8.2KΩ
KNP08W	KNP-800	8W	8.5	39.5	0.75	38	0.15Ω ~ 12KΩ
KNP09W	KNP-900	9W	8.5	52.5	0.75	38	0.22Ω ~ 15KΩ
<b>Small Size (小型化尺寸)</b>							
KNP01S	KNP-100-S	1W	4.0	9.5	0.60	28	0.01Ω ~ 820Ω
KNP02S	KNP-200-S	2W	4.5	11.5	0.65	28	0.01Ω ~ 1.2KΩ
KNP03S	KNP-300-S	3W	5.5	15.5	0.70	28	0.01Ω ~ 3.0KΩ
KNP05S	KNP-500-S	5W	6.5	17.5	0.75	28	0.039Ω ~ 3.9KΩ
KNP07S	KNP-700-S	7W	8.5	24.5	0.75	38	0.082Ω ~ 5.6KΩ
KNP08S	KNP-800-S	8W	8.5	29.5	0.75	38	0.1Ω ~ 8.2KΩ
KNP09S	KNP-900-S	9W	8.5	39.5	0.75	38	0.15Ω ~ 12KΩ
KNP0AS	KNP-1000-S	10W	8.5	52.5	0.75	38	0.22Ω ~ 15KΩ

### KNH Type (KNH型)

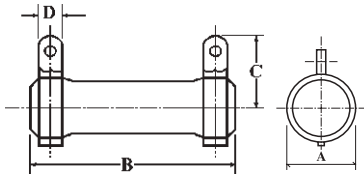

### Derating Curve (降功率曲线)

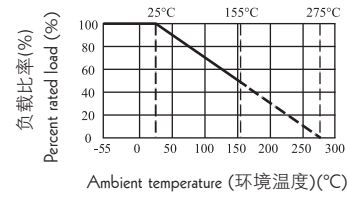

Part No. 料号	Type 类型	Power Rating 功率 70°C	Dimension (尺寸)(mm)				Resistance Range 阻值范围
			A ± 1.5	B ± 1.5	C ± 3	D ± 1	
KNH020	KNH-20W	20W	19	50	19	5	0.4Ω ~ 1KΩ
KNH025	KNH-25W	25W	19	60	19	5	0.4Ω ~ 1KΩ
KNH030	KNH-30W	30W	19	75	19	5	0.5Ω ~ 3KΩ
KNH040	KNH-40W	40W	19	90	19	5	0.6Ω ~ 5KΩ
KNH050	KNH-50W	50W	31	75	31	8	3Ω ~ 10KΩ
KNH060	KNH-60W	60W	31	90	31	8	3Ω ~ 15KΩ
KNH080	KNH-80W	80W	31	115	31	8	3Ω ~ 20KΩ
KNH ..... 100	KNH-100W	100W	31	140	31	8	3Ω ~ 30KΩ

### Performance Specification (性能)

Temperature coefficient	温度系数	≥20Ω: ±300PPM/°C, <20Ω: ±400PPM/°C
Short-time overload	短时间过负荷	ΔR/R ≤ ±(2%+0.05Ω), with no evidence of mechanical damage (无可见机械损伤)
Terminal strength	端子强度	No evidence of mechanical damage (无可见机械损伤)
Soldering heat	耐焊接热	ΔR/R ≤ ±(1%+0.05Ω), with no evidence of mechanical damage (无可见机械损伤)
Solderability	可焊性	Min. 95% coverage (最少 95% 覆盖率)
Load life in humidity	湿度寿命	ΔR/R ≤ ±(5%+0.05Ω), with no evidence of mechanical damage (无可见机械损伤)
Load life	负载寿命	ΔR/R ≤ ±(5%+0.05Ω), with no evidence of mechanical damage (无可见机械损伤)

### Ordering Procedure (Example: KNP 3W-S 5% 12Ω T/B-1000)

订购方式 (例如: KNP 3W-S 5% 12Ω T/B-1000)

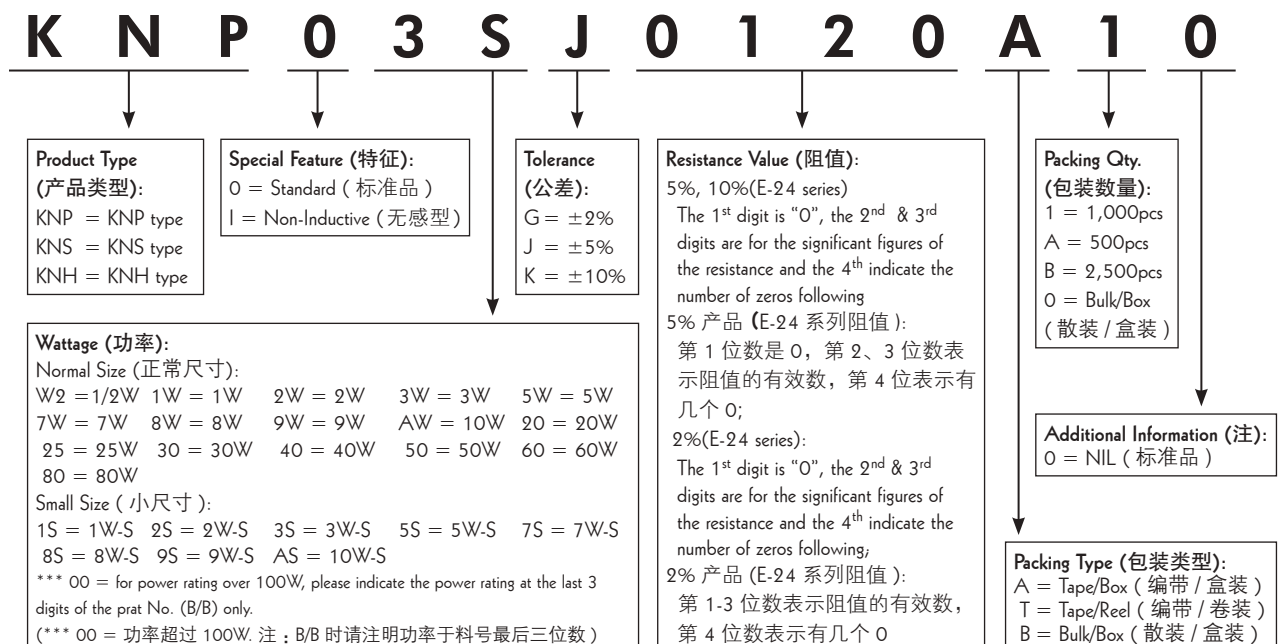

Feature (特性)

- Excellent flame retardant coating (优异不燃性涂装)
- According to IEC 61000-4-5 (符合 IEC61000-4-5 标准)
- Applies to electricity meters, appliances and ballast (适用于电表、家电及镇流器产品)

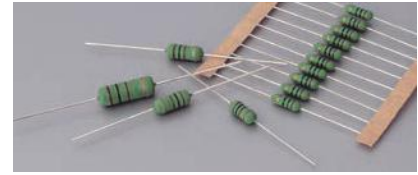

Dimension (mm)

尺寸 (mm)

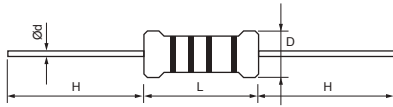

Derating Curve

降功率曲线

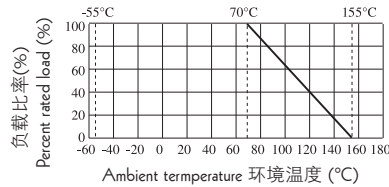

1.2/50µs Pulse Withstanding Curve

1.2/50µs脉冲曲线

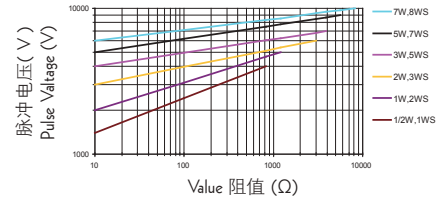

Specification (性能)

Part No. 料号	Type 类型	Dimension (尺寸) (mm)				Resistance Range 阻值范围
		D±1	L ±1	d±0.05	H±3	
KSR 0W2, 01S	KSR-50, KSR-100-S	4.5	9.5	0.65	28	10Ω~820Ω
KSR 01W, 02S	KSR-100, KSR-200-S	5.0	11.5	0.65	28	10Ω~1.2KΩ
KSR 02W, 03S	KSR-200, KSR-300-S	5.5	15.5	0.75	28	10Ω~3.0KΩ
KSR 03W, 05S	KSR-300, KSR-500-S	6.5	17.5	0.75	28	10Ω~3.9KΩ
KSR05W, 07S	KSR-500, KSR-700-S	8.5	24.5	0.75	38	10Ω~5.6KΩ
KSR07W, 08S	KSR-700, KSR-800-S	8.5	29.5	0.75	38	10Ω~8.2KΩ

Specification (性能)

Temperature coefficient	温度系数	±200PPM
Short-time Overload	短时间过负荷	ΔR/R±(5%+0.05Ω)
Terminal strength	端子强度	no evidence of mechanical damage (无可见机械损伤)
Resistance to soldering heat	耐焊接热	ΔR/R±(1%+0.05Ω)
Solderability	可焊性	Min.95% coverage (最少 95% 覆盖率)
Temperature cycling	温度循环	ΔR/R±(2%+0.05Ω)
Humidity (Steady State)	恒定湿热	ΔR/R±(2%+0.05Ω)
Load life in humidity	湿度寿命	ΔR/R±(5%+0.05Ω)
Load life	负载寿命	ΔR/R±(5%+0.05Ω)
Resistance to solvent	耐溶剂	no evidence of mechanical damage (无可见机械损伤)

Ordering Procedure (Example: KSR 1/2W 5% 820Ω T/B-1000)

订购方式 (例如: KSR 1/2W 5% 820Ω T/B-1000)

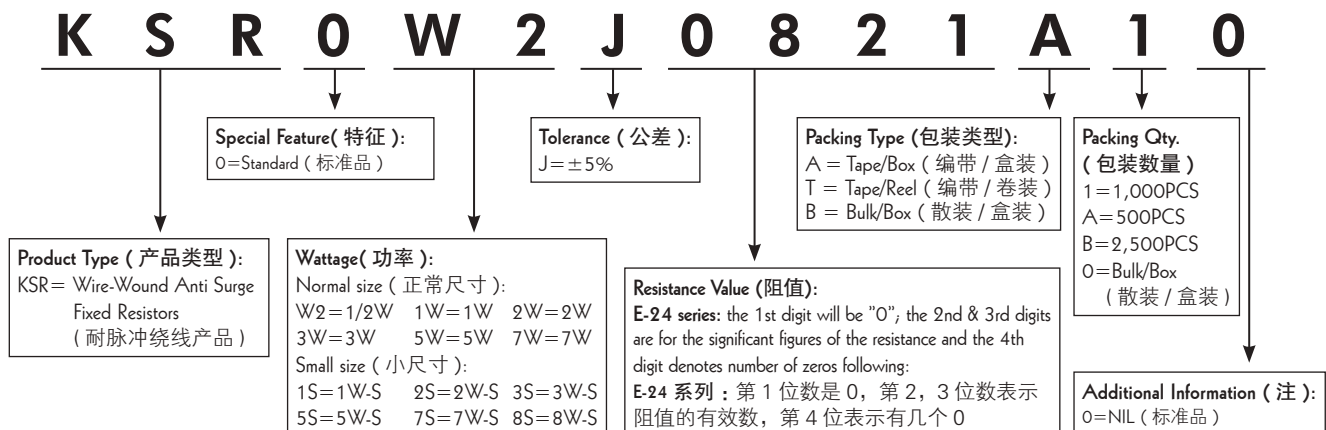

### Feature (特性)

- Small body size 体积小
- High power 功率大
- Excellent flame retardant coating 优异的阻燃封装
- Provides stable performance in various environments 在各种环境中提供优异的稳定性的



### Derating Curve (降功率曲线)

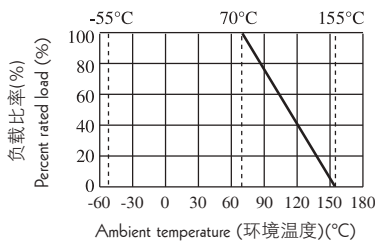

### Dimension (尺寸) (mm)

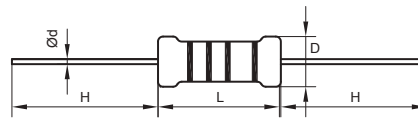

### Surge Withstanding Curve (脉冲曲线)

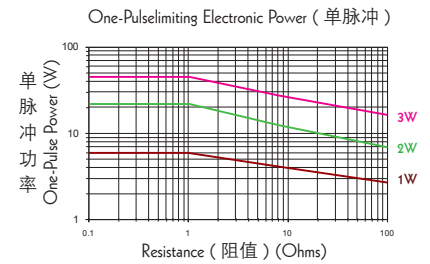

Part No. 料号	Type 类型	Power Rating 功率 70°C	Dimension (尺寸)(mm)				Max. Working Voltage 最大工作电压	Dielectric Withstanding Voltage 绝缘耐压	Resistance Range 阻值范围
			D±1	L±1	d±0.05	H±3			
WPRO1W	WPR-100	1W	2.5	6.2	0.60	28	50V	250V	0.1Ω~300Ω
WPRO2W	WPR-200	2W	3.5	9.0	0.80	28	50V	250V	0.1Ω~1KΩ
WPRO3W	WPR-300	3W	4.5	10.5	0.80	28	50V	350V	0.1Ω~1KΩ

### Performance Specification (性能)

Temperature coefficient 温度系数	±200PPM/°C
Short-time overload 短时间过负荷	ΔR/R ≤ ±(5.0%+0.05Ω) with no evidence of mechanical damage (无可见机械损伤)
Terminal strength 端子强度	No evidence of mechanical damage (无可见机械损伤)
Solderability 可焊性	Min. 95% coverage (最少 95% 覆盖率)
Soldering heat 耐焊接热	ΔR/R ≤ ±(1.0%+0.05Ω)
Insulation resistance 绝缘电阻	≥1,000 MΩ
Temperature cycling 温度循环	ΔR/R ≤ ±(2.0%+0.05Ω)
Resistance to solvent 耐溶剂	No deterioration of protective coating and markings (包封层, 色码完整)
Humidity (steady State) 恒定湿热	ΔR/R ≤ ±(2.0%+0.05Ω) with no evidence of mechanical damage (无可见机械损伤)
Load life 负载寿命	ΔR/R ≤ ±(5.0%+0.05Ω)
Load life in humidity 湿度寿命	ΔR/R ≤ ±(5.0%+0.05Ω)
Pulse test 脉冲测试	ΔR/R ≤ ±(5.0%+0.05Ω)

Feature (特性)

- Ideal circuit opening controller, disconnecting units from overload rating 理想的电流过负荷保护元件
- Too low or too high ohmic value can be supplied on a case to case basis 超高或超低阻值也能特别生产

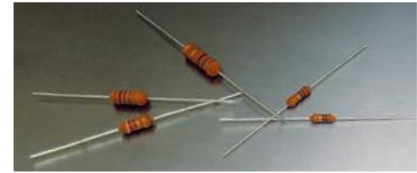
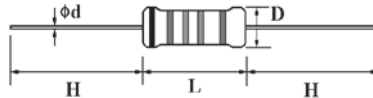

Fusing Characteristics (熔断特性)

Resistance Value (阻值)	Test Wattage (测试功率)	Fusing Time (熔断时间)
≤ 2.2Ω	32 X Power Rating (额定功率)	≤ 60 seconds (秒)
> 2.2Ω	16 X Power Rating (额定功率)	≤ 60 seconds (秒)

The fusing test current or voltage should be stable, change within 5%. (测试电流或电压必须稳定变化率不超过 5%)

Derating Curve (降功率曲线)

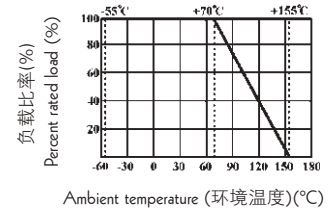

Specification (性能)

Part No. 料号	Type 类型	Power Rating 功率 70°C	Dimension (尺寸)(mm)				Dielectric Withstanding Voltage 绝缘耐压	Resistance Range 阻值范围
			D±0.5	L±1.0	d±0.05	H±3		
FRN0W4	FRN-25	1/4W	2.2	6.5	0.54	28	300V	0.22Ω ~ 10KΩ
FRN0W2	FRN-50	1/2W	3.0	9.0	0.54	28	350V	0.22Ω ~ 10KΩ
FRN01W	FRN-100	1W	3.5	9.5	0.65	28	350V	0.22Ω ~ 10KΩ
FRN02W	FRN-200	2W	4.5	11.5	0.65	28	600V	0.22Ω ~ 10KΩ
FRN03W	FRN-300	3W	5.0	15.5	0.70	28	600V	0.22Ω ~ 10KΩ

Performance Specification (性能)

Temperature coefficient 温度系数	± 350PPM / °C
Short-time overload 短时间过负荷	ΔR/R ≤ ±(2%+0.05Ω) with no evidence of mechanical damage (无可见机械损伤)
Dielectric withstanding voltage 绝缘耐压	No evidence of flashover, mechanical damage, arcing or insulation breakdown (无击穿、飞弧及可见机械损伤)
Terminal strength 端子强度	No evidence of mechanical damage (无可见机械损伤)
Soldering heat 耐焊接热	ΔR/R ≤ ±(1%+0.05Ω) with no evidence of mechanical damage (无可见机械损伤)
Solderability 可焊性	Min. 95% coverage (最少 95% 覆盖率)
Temperature cycling 温度循环	ΔR/R ≤ ±(2%+0.05Ω) with no evidence of mechanical damage (无可见机械损伤)
Load life in humidity 湿度寿命	ΔR/R ≤ ±(5%+0.05Ω) with no evidence of mechanical damage (无可见机械损伤)
Load life 负载寿命	ΔR/R ≤ ±(5%+0.05Ω) with no evidence of mechanical damage (无可见机械损伤)
Flame retardant 阻燃	Not have any specimens which burn with flaming combustion after each application of the test flame (无可见燃烧或飞弧)



Ordering Procedure (Example: FRN 1W 5% 1Ω T/B-1000)

订购方式 (例如: FRN 1W 5% 1Ω T/B-1000)

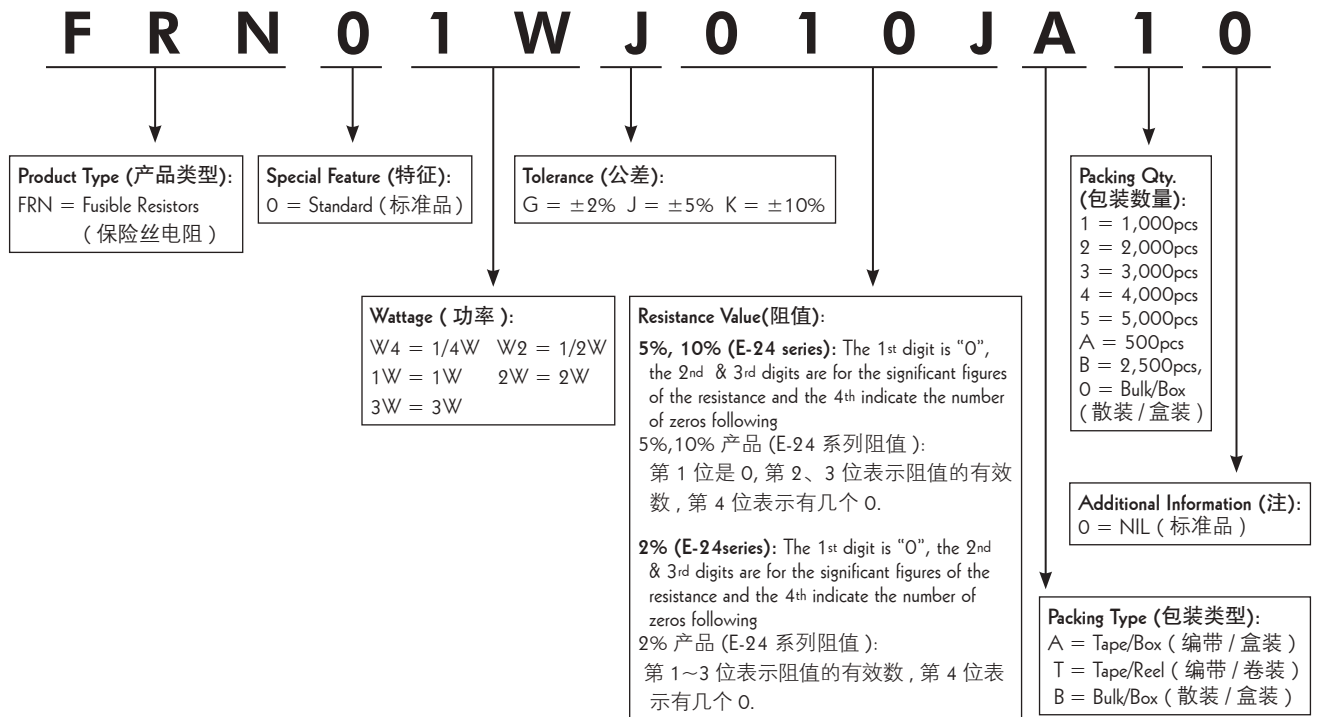

Feature (特性)

1. Suitable for all kinds of protection circuit  
适用各种保护电路
2. Non-flammable coating, could withstand High Temperature  
优异不燃性涂装, 耐高温
3. Common resistor with additional safety function, no flame or smoke, no explosion or coating crack when fusing  
常见的电阻器具有额外的安全性能, 无火焰或烟, 无爆炸或涂层裂纹

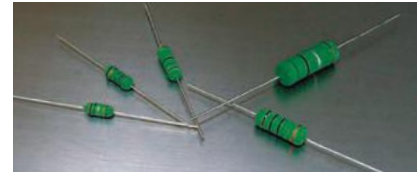
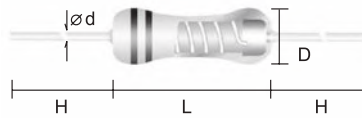

Specification (性能)

Part No. 料号	Type 类型	Dimension (尺寸)(mm)				Tolerance 公差	Resistance Range 阻值范围
		D ±1.0	L ±1.0	d ±0.05	H ±3		
KFR01W	KFR-100	3.5	9.5	0.55	28	±5%	4.7Ω~47Ω
KFR02W	KFR-200	4.5	11.5	0.65	28		
KFR03W	KFR-300	5.5	15.5	0.75	28		
KFR05W	KFR-500	6.5	17.5	0.75	28		
KFR07W	KFR-700	8.5	24.5	0.75	38		

Fusing Characteristics (熔断特性)

Fusing time could be designed according to customer's circuit Spec.

The following are necessary information must be provided for any Fusing time Spec. request:

1. Working ambient temperature & Working voltage
2. The Rated Power or Current
3. Requested Fusing Power or Current
4. Resistance Value & Tolerance
5. The requirement of the Resistor Body Size
6. The Wave of Voltage & the Frequency
7. Other general condition in circuit

熔断时间可根据客户的电路要求设计

为满足客户的特殊熔断性能要求, 以下条件必须提供:

1. 工作环境温度和工作电压
2. 额定功率和电流
3. 熔断功率和电流
4. 阻值和公差
5. 电阻本体可允许的最小或最大尺寸 (如有要求时)
6. 电压的波动及中心测量频率
7. 有关电路的其它信息

Performance Specification (性能)

Temperature coefficient	温度系数	±300PPM/°C
Short-time overload	短时间过负荷	$\Delta R/R \leq \pm(5\% \pm 0.05\Omega)$ , with no evidence of mechanical damage (无可见机械损伤)
Dielectric withstanding voltage	绝缘耐压	No evidence of flashover, mechanical damage.(500V). [无击穿、飞弧及可见机械损伤(500V)]
Terminal strength	端子强度	No evidence of mechanical damage (无可见机械损伤)
Soldering heat	耐焊接热	$\Delta R/R \leq \pm(1\% \pm 0.05\Omega)$ , with no evidence of mechanical damage (无可见机械损伤)
Solderability	可焊性	Min. 95% coverage (最小95%覆盖率)
Load life in humidity	湿度寿命	$\Delta R/R \leq \pm(5\% \pm 0.05\Omega)$ , with no evidence of mechanical damage (无可见机械损伤)
Load life	负载寿命	$\Delta R/R \leq \pm(5\% \pm 0.05\Omega)$ , with no evidence of mechanical damage (无可见机械损伤)

### Ordering Procedure (Example: KFR 1W 5% 10Ω T/B-1000)

订购方式 (例如: KFR 1W 5% 10Ω T/B-1000)

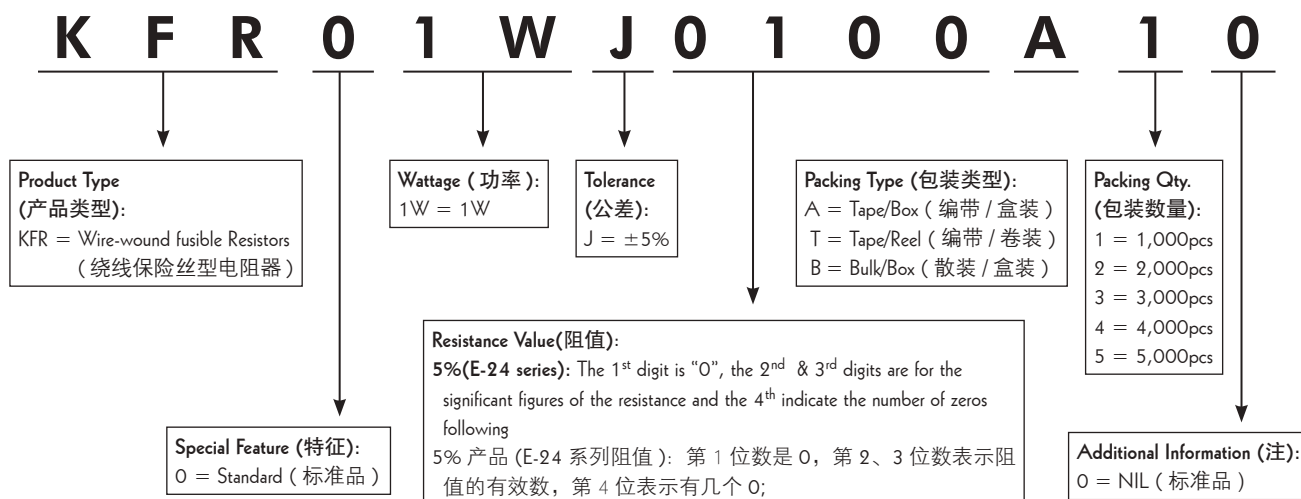

Dimension (尺寸) (mm)

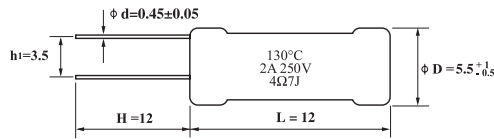

Derating Curve (降功率曲线)

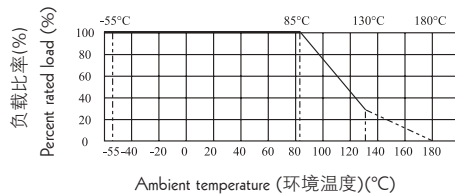

Type 类型	Power Rating 功率 70°C	Tolerance 公差	Resistance Value 阻值	Fusing Temperature 额定熔断温度 T <sub>F</sub> (C)	Holding Temperature 保持温度 T <sub>H</sub> / T <sub>C</sub> (C)	Max. Temperature 极限温度 T <sub>M</sub> (C)	Rated Current 额定电流 I <sub>r</sub> (A)	Rated Voltage 额定电压 U <sub>r</sub> (V)
TFR	1W	±5%	4Ω7	130	102	180	2	250

Performance Specification (性能)

Temperature coefficient 温度系数	± 400 PPM/°C
Short-time overload 短时间过负荷	ΔR/R ≤ ±(2%+0.05Ω), with no evidence of mechanical damage (无可见机械损伤)
Insulation resistance 绝缘阻值	≥ 20,000MΩ
Dielectric withstanding voltage 绝缘耐压	No evidence of flashover, mechanical damage, arcing or insulation breakdown (无击穿、飞弧及可见机械损伤)
Terminal strength 端子强度	No evidence of mechanical damage (无可见机械损伤)
Humidity (Steady State) 恒定湿热	ΔR/R ≤ ±(3%+0.05Ω), with no evidence of mechanical damage (无可见机械损伤)
Load life in humidity 湿度寿命	ΔR/R ≤ ±(5%+0.05Ω), with no evidence of mechanical damage (无可见机械损伤)
Load life 负载寿命	ΔR/R ≤ ±(5%+0.05Ω), with no evidence of mechanical damage (无可见机械损伤)

### Feature (特性)

- Made by Cu/Ni or Mn/Cu Alloy resistance wire materials 由铜/镍或锰/铜合金电阻线制成
- Excellent Solderability 优越的焊接性能
- Suitable for all kinds of Current sense application 适用于各种类型的电流感应器应用
- Application: Power Supply 电源供应器

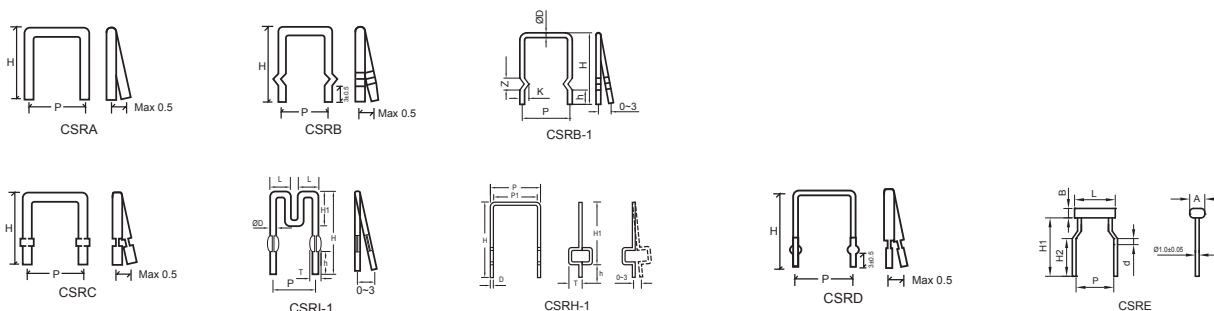
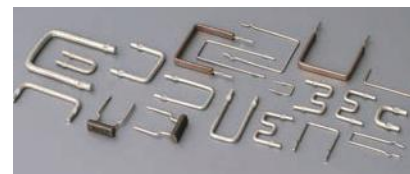

Type 规格	CSRA CSRB CSRC CSRI CSRH															
Ød mm 线径	0.4	0.5	0.6	0.7	0.8	0.9	1.0	1.1	1.2	1.3	1.4	1.5	1.6	1.8	2.0	2.3
Rated Current 额定电流	2.0A	2.5A	3.0A	4.0A	4.5A	5.0A	5.5A	6.0A	7.0A	7.5A	8.0A	9.0A	9.5A	11A	12A	14A
TCR 温度系数	±100PPM															
Resistance Range 阻值范围 ±5%	80mΩ - 200mΩ	60mΩ - 150mΩ	60mΩ - 100mΩ	35mΩ - 60mΩ	5mΩ - 50mΩ	5mΩ - 40mΩ	3mΩ - 30mΩ	3mΩ - 20mΩ	3mΩ - 20mΩ	3mΩ - 20mΩ	3mΩ - 20mΩ	3mΩ - 20mΩ	3mΩ - 15mΩ	3mΩ - 10mΩ	3mΩ - 10mΩ	3mΩ - 7mΩ
Remark 备注	Diameter according to this table listed, P & H could be design by customer's requirement. 线径如本表所示, P值和H值可根据客户的要求进行设计															

### CSRD (Flat Wire Type) (扁线型)

Type 规格	Rated Power 额定功率	H max (mm) H 最大 (mm)	P max (mm) P 最大 (mm)	TCR 温度系数	Resistance Range 阻值范围 ±1%, ±5%
CSRD	1W	11	5	±20PPM	5mΩ - 10mΩ
	3W	25	15		5mΩ - 10mΩ
	5W	25	20		5mΩ - 10mΩ

### Ordering Procedure (Example: CSRC15J045MB00)

订购方式 (例如: CSRC15J045MB00)

**C S R C 1 5 J 0 4 5 M B 0 0**

**Type (类型):**  
 CSRA = A type  
 CSRB = B type  
 CSRC = C type  
 CSRD = D type  
 CSRE = E type  
 CSRI = I type  
 CSRH = H type

**Wire Ø (线径 Ø):**  
 08=Ø0.8 10=Ø1.0  
 12=Ø1.2 15=Ø1.5  
 16=Ø1.6 20=Ø2.0  
 23=Ø2.3

**Tolerance (公差):**  
 G = ±2%  
 J = ±5%  
 K = ±10%

**Resistance Value (阻值):**  
 5%, 10% (E-24 series)  
 The 1<sup>st</sup> digit is "0", the 2<sup>nd</sup> & 3<sup>rd</sup> digits are for the significant figures of the resistance and the 4<sup>th</sup> indicate the number of zeros following  
 5%、10% 产品 (E-24 系列阻值): 第 1 位是 0, 第 2、3 位表示阻值的有效数, 第 4 位表示有几个 0.  
 2%(E-24 series):  
 The 1<sup>st</sup> digit is "0", the 2<sup>nd</sup> & 3<sup>rd</sup> digits are for the significant figures of the resistance and the 4<sup>th</sup> indicate the number of zeros following  
 2% 产品 (E-24 系列阻值): 第 1-3 位表示阻的有效数, 第 4 位表示有几个 0.

**Packing Qty. (包装数量):**  
 0=B/B (散装)

**Additional Information (注):**  
 0 = NIL (标准品)

**Packing Type (包装类型):**  
 B = Bulk/Box (散装 / 盒装)

Feature (特性)

- Made of copper / nickel or manganese / copper alloy resistance wire (由铜 / 镍或锰 / 铜合金电阻线制成)
- Superior welding performance (优越的焊接性能)
- Applies to all types of current sensor applications (适用于各种类型的电流传感器应用)
- Power Supply (电源供应器)



Dimension (尺寸)(mm)

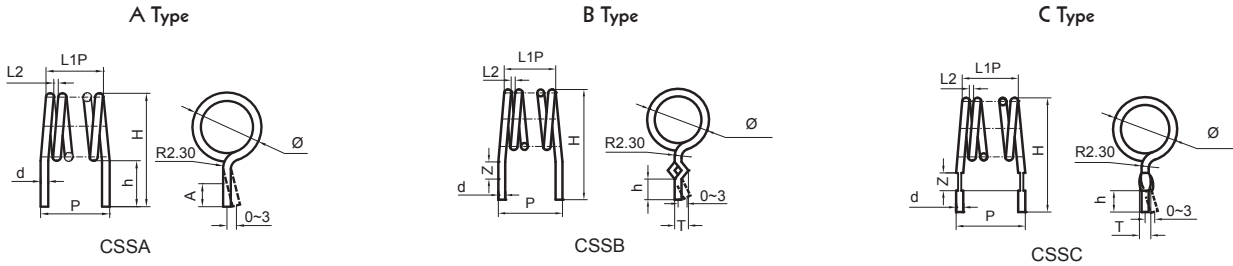

Specification (性能)

Size 规格	Wire 线径	Rated current 额定电流	T.C.R 温度系数	Resistance Range 阻值范围 ±5%
CSSA CSSB CSSC	0.8	4.5A	±100PPM	15mΩ~100mΩ
	1.0	5.5A		10mΩ~100mΩ
	1.6	9.5A		10mΩ~50mΩ
	2.0	12A		10mΩ~50mΩ

• Diameter according to this table listed, d, P, h, H, Ø could be design by customer's requirement (线径如本表所示, d、P、h、H、Ø 可以根据客户的要求进行设计)

Ordering Procedure (Example: CSSCØ1.0 5% 50mΩ B/B)

订购方式 (例如: CSSC10J050LB00)

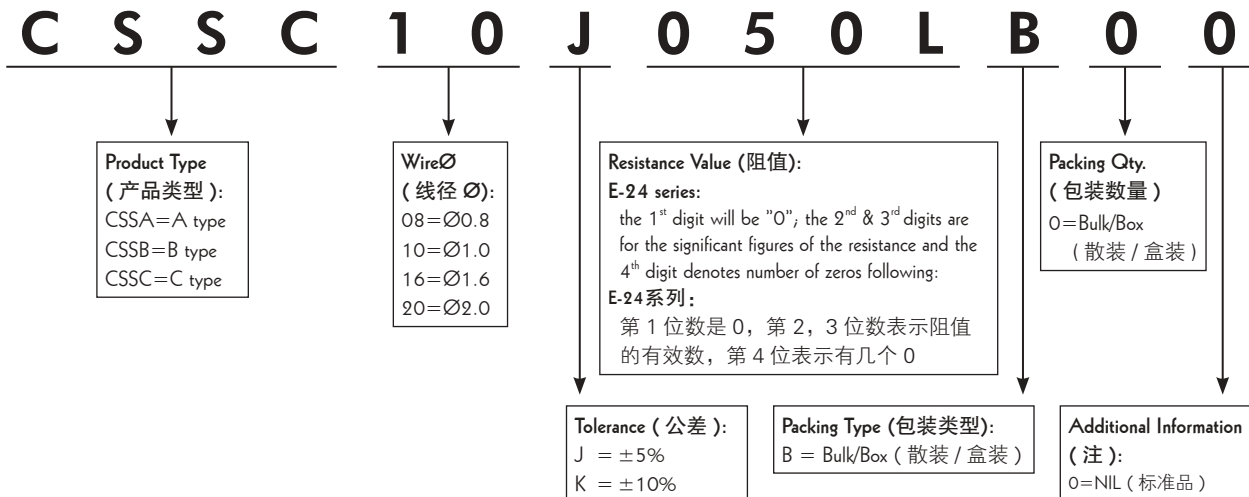

### Feature (特性)

- Provide high stable performance against environment conditions & overload voltage  
耐高压，稳定性强，抗湿热高温环境
- Can withstand High Surge Voltage  
可承受高浪涌电压
- Width resistance range & low TCR  
阻值范围宽，温度系数低

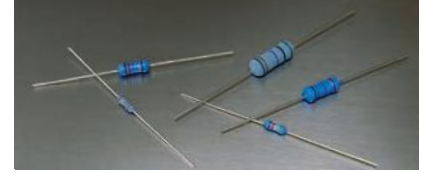

- 5 band color code for  $\pm 5\%$  tolerance, and last band Black color for identification  
公差  $\pm 5\%$  有五道色码，最后一道以黑色标示

- Standard 5 band color code for  $\pm 1\%$  tolerance  
公差  $\pm 1\%$  有五道色码

### Surge Withstanding Voltage (承受浪涌电压)

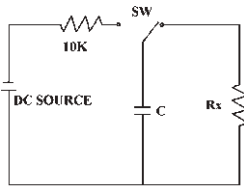

### Derating Curve (降功率曲线)

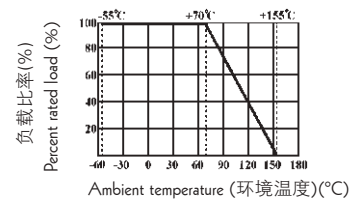

- Normal Size: the discharge cycle is repeated in above circuit: 2.5 seconds "ON", 2.5 seconds "OFF", 50 cycles,  $C=0.001\mu f$   
正常尺寸: 上图中充放电回路: 2.5秒"通", 2.5秒"断", 50次循环, 电容容值 $C=0.001\mu f$
- Small Size: the discharge cycle is repeated in above circuit: 2.5 seconds "ON", 2.5 seconds "OFF", 10 cycles,  $C=0.01\mu f$   
小型化产品: 上图中充放电回路: 2.5秒"通", 2.5秒"断", 10次循环, 电容容值 $C=0.01\mu f$
- The applied DC source voltage is shown as below table (电路中的直流电压如下表“承受浪涌电压”所述)

### Specification (性能)

Part No. 料号	Type 型号	Power Rating 功率 70°C	Dimension(尺寸)(mm)				Max. Working Voltage 最大工作电压	Max. Overload Voltage 最大过负荷电压	Dielectric Withstanding Voltage 绝缘耐压	Surge Withstanding Voltage 浪涌电压	Resistance Range 阻值范围
			D $\pm 0.5$	L $\pm 1.0$	d $\pm 0.05$	H $\pm 3$					
<b>Normal Size (正常尺寸)</b>											
MGR 0W4	MGR 25	1/4W	2.2	6.5	0.54	28	500V	700V	500V	100K-100M: 10,000V	1K-100M ( $\pm 5\%$ , $\pm 10\%$ )
MGR 0W2	MGR 50	1/2W	3.0	9.5	0.54	28	700V	1,000V	700V		
MGR 01W	MGR-100	1W	4.0	11.5	0.65	28	1,000V	1,400V	700V		
MGR 02W	MGR-200	2W	5.0	15.5	0.75	28	1,000V	1,400V	700V		
MGR 03W	MGR-300	3W	6.0	17.5	0.75	28	1,000V	1,400V	700V		100K-1M( $\pm 1\%$ )
<b>Small Size &amp; Ultra Small Size (小型化及超小型化尺寸)</b>											
MGR0U2	MGR-50-SS	1/2W	2.2	6.5	0.54	28	500V	700V	500V	100K-1M:3,000V 1M1-6M2:4,000V $\geq 6M8$ : 6,000V	1K-33M ( $\pm 5\%$ , $\pm 10\%$ )
MGR0S2	MGR-50-S	1/2W	3.0	9.0	0.54	28	500V	700V	500V	100K-1M:3,000V 1M1-6M2:4,000V $\geq 6M8$ : 6,000V	100K-1M ( $\pm 1\%$ )
MGR01U	MGR-100-SS	1W	3.5	9.5	0.54	28	700V	1,000V	700V	100K-1M:4,000V 1M1-6M2:5,000V $\geq 6M8$ : 8,000V	1K-33M ( $\pm 5\%$ , $\pm 10\%$ )
MGR01S	MGR-100-S	1W	3.5	9.5	0.65	28	700V	1,000V	700V		
MGR02U	MGR-200-SS	2W	4.0	11.5	0.65	28	1,000V	1,400V	700V		
MGR02S	MGR-200-S	2W	4.5	11.5	0.65	28	1,000V	1,400V	700V		
MGR03U	MGR-300-SS	3W	4.5	11.5	0.75	28	1,000V	1,400V	700V	100K-1M:5,000V 1M1-6M2:6,000V $\geq 6M8$ : 9,000V	100K-1M ( $\pm 1\%$ )
MGR03S	MGR-300-S	3W	5.0	15.5	0.75	28	1,000V	1,400V	700V	100K-1M:8,000V 1M1-6M2:9,000V $\geq 6M8$ :10,000V	

Performance Specifications (性能)

Temperature coefficient	温度系数	$\leq \pm 200\text{PPM}/^\circ\text{C}$
Short-time overload	短时间过负荷	$\Delta R/R \leq \pm(1\%+0.05\Omega)$ , with no evidence of mechanical damage (无可见机械损伤)
Dielectric withstanding voltage	绝缘耐压	No evidence of flashover, mechanical damage, arcing or insulation breakdown (无击穿、飞弧及可见机械损伤)
Pulse overload	脉冲过负荷	$\Delta R/R \leq \pm(2\%+0.05\Omega)$ , with no evidence of mechanical damage (无可见机械损伤)
Terminal strength	端子强度	No evidence of mechanical damage (无可见机械损伤)
Soldering heat	耐焊接热	$\Delta R/R \leq \pm(1\%+0.05\Omega)$ , with no evidence of mechanical damage (无可见机械损伤)
Solderability	可焊性	Min. 95% coverage (最少 95% 覆盖率)
Resistance to solvent	耐溶剂	No deterioration of protective coating and marking (包封层, 色码完整)
Temperature cycling	温度循环	$\Delta R/R \leq \pm(1\%+0.05\Omega)$ , with no evidence of mechanical damage (无可见机械损伤)
Load life in humidity	湿度寿命	$\Delta R/R \leq \pm(5\%+0.05\Omega)$ , with no evidence of mechanical damage (无可见机械损伤)
Load life	负载寿命	$\Delta R/R \leq \pm(5\%+0.05\Omega)$ , with no evidence of mechanical damage (无可见机械损伤)

Ordering Procedure (Example: MGR 1W 5% 27MΩ T/B-1000)

订购方式 (例如: MGR 1W 5% 27MΩ T/B-1000)

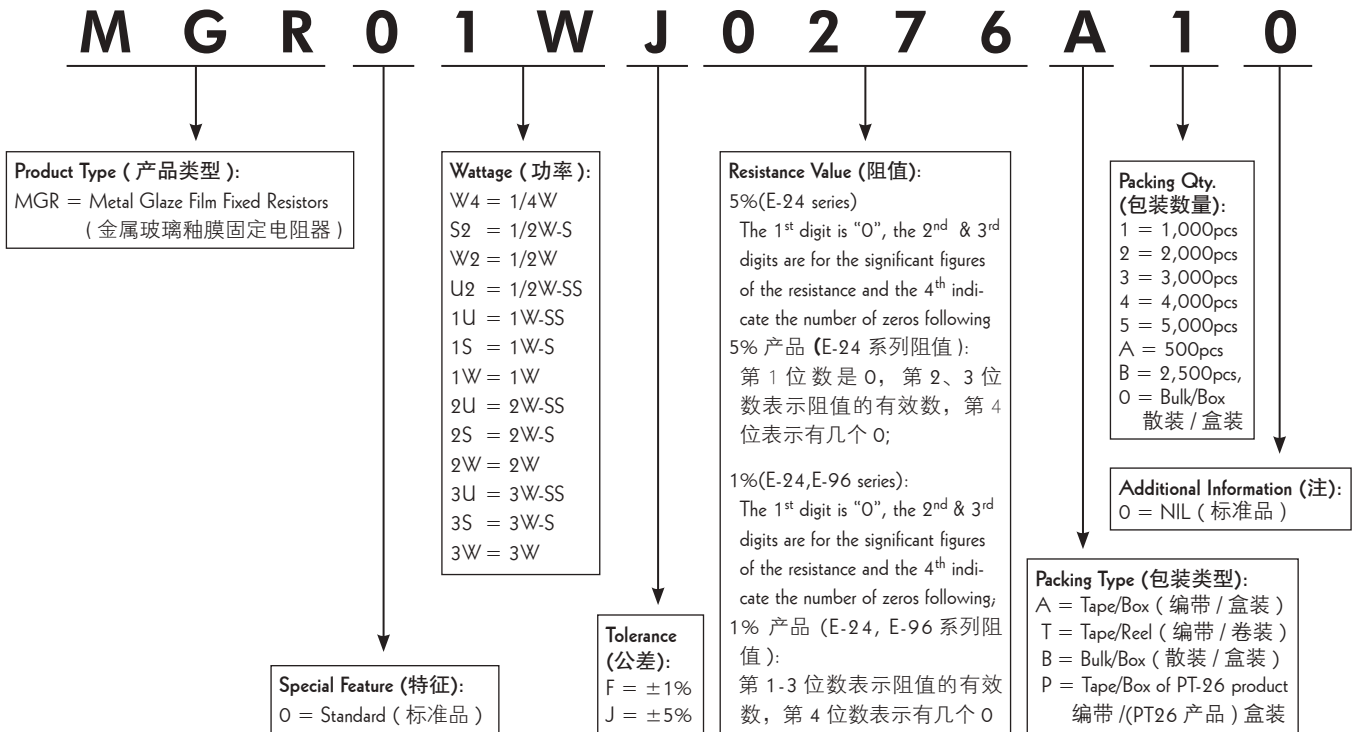



### Surge Withstanding Voltage (承受浪涌电压)

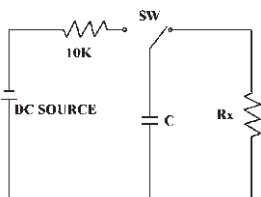

Discharge cycle: 2.5 seconds "ON", 2.5 seconds "OFF", 50 cycles, C=0.001uF  
 充放电回路: 2.5秒“通”, 2.5秒“断”, 50次循环, 电容容值 C=0.001uF

### Derating Curve (降功率曲线)

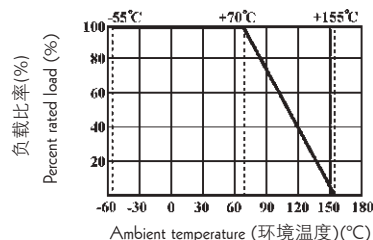

### Specification (性能)

Part No. 料号	Type 类型	Power Rating 功率 70°C	Dimension (尺寸)(mm)				Max. Working Voltage 最大工作电压	Max. Overload Voltage 最大过负荷电压	Dielectric Withstanding Voltage 绝缘耐压	Surge Withstanding Voltage 浪涌电压	Resistance Range 阻值范围
			D±0.5	L±1.0	d±0.05	H±3					
HMGR 0W4	HMGR-25	1/4W	2.2	6.5	0.6	28	500V	1,000V	700V	10 KV	500K-510MΩ (5% 10%) ≤10M ±1% 10M~100M: ±2%
HMGR 0W2	HMGR-50	1/2W	3.0	9.5	0.6	28	1,000V	2,000V	700V		
HMGR 01W	HMGR-100	1W	4.0	11.5	0.7	28	2,000V	3,000V	1,000V		
HMGR 02W	HMGR-200	2W	5.0	15.5	0.8	28	3,000V	4,000V	1,000V		500K-1GΩ (5% 10%) ≤10M ±1% 10M~100M: ±2% 101M~510M: ±5%

### Ordering Procedure (Example: HMGR 1W 5% 200MΩ T/B -1000)

订购方式 (例如: HMGR 1W 5% 200MΩ T/B -1000)

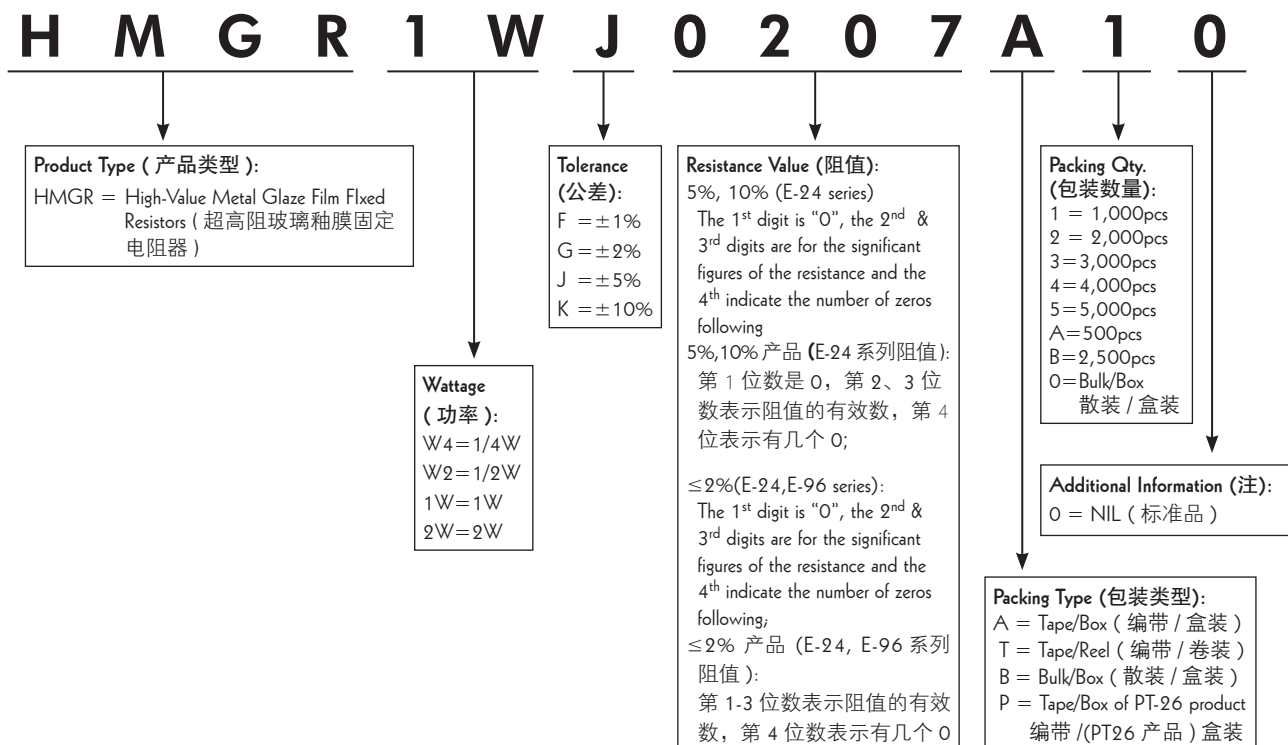

Surge Withstanding Voltage (承受浪涌电压)

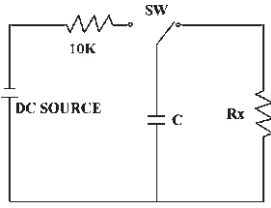

Discharge cycle: 2.5 seconds "ON", 2.5 seconds "OFF", 50 cycles, C=0.001uF  
 充放电回路: 2.5秒“通”, 2.5秒“断”, 50次循环, 电容容值 C=0.001uF

Derating Curve (降功率曲线)

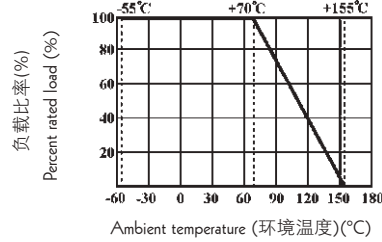

Specification (性能)

Part No. 料号	Type 类型	Power Rating 功率 70°C	Dimension (尺寸)(mm)				Max. Working Voltage 最大工作电压	Max. Overload Voltage 最大过负荷电压	Dielectric Withstanding Voltage 绝缘耐压	Surge Withstanding Voltage 浪涌电压	Resistance Range 阻值范围
			D±0.5	L±1.0	d±0.05	H±3					
HVR0W4	HVR-25	1/4W	2.5	6.5	0.6	28	1,600V	2,000V	700V	10,000V	100K - 100M (±5%, ±10%)
HVR0W2	HVR-50	1/2W	3.5	9.5	0.6	28	3,500V	4,000V	700V		100K - 1M (±1%)
HVR01W	HVR-100	1W	4.5	11.5	0.7	28	3,500V	4,000V	1000V		
HVR02W	HVR-200	2W	5.5	16.0	0.8	28	3,500V	4,000V	1000V		

Ordering Procedure (Example: HVR 1W 5% 27MΩ T/B -1000)

订购方式 (例如: HVR 1W 5% 27MΩ T/B -1000)

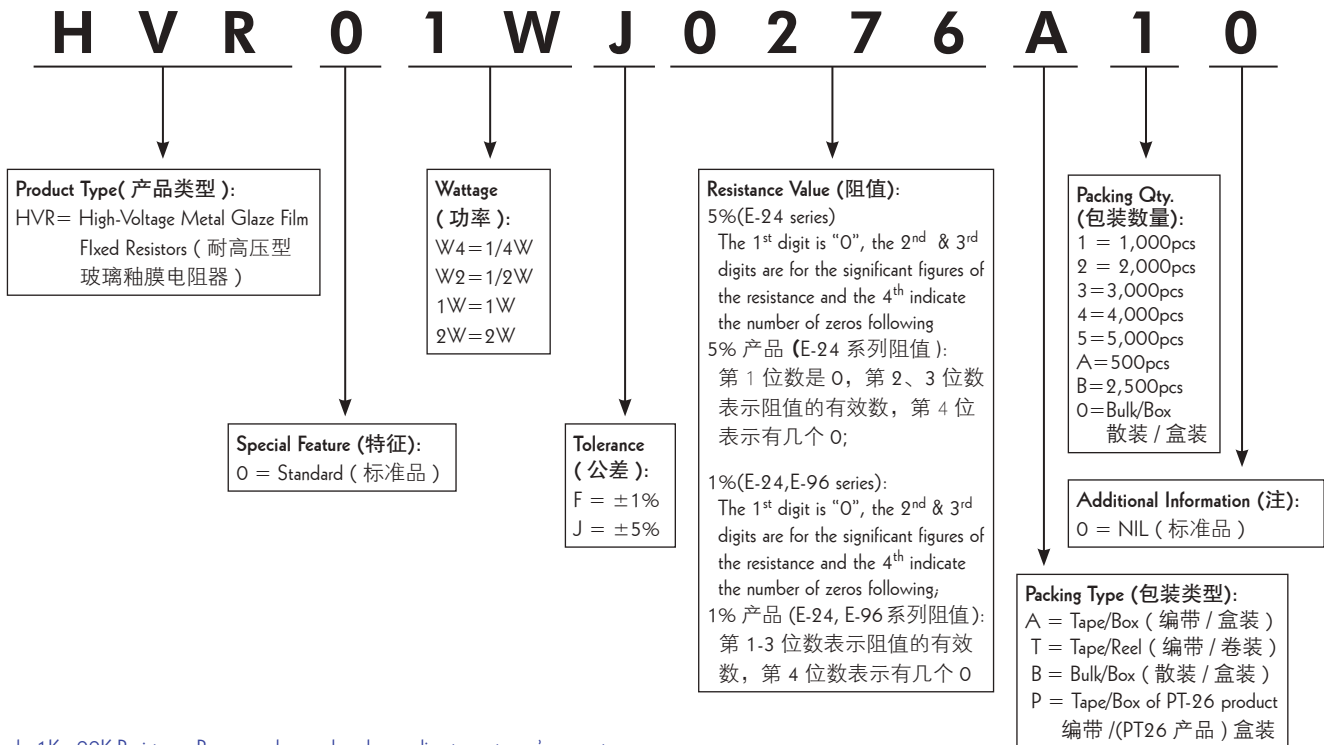

Remark: 1K~99K Resistance Range can be produced according to customer's request.  
 备注: 1K~99K 阻值也可以根据客户的要求生产。

### Feature (特性)

- Excellent flame retardant coating 优异不燃性涂装
- High Stability even in bad environment 恶劣环境下同样稳定工作
- High purity ceramic core 高纯度瓷芯
- High safety standard 电器性能稳定
- Meet EIAJ-RC2655A requirements 达到 EIAJ-RC2655A 标准要求
- Too low or too high ohmic value can be provided on a case to case basis 超低或超高阻值也能特别提供

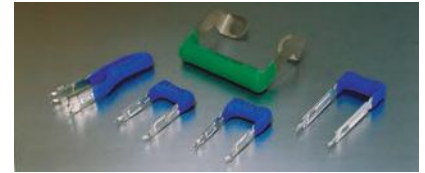

### Vertical type - TMOV

端片 MOR 电阻-立式 (TMOV)

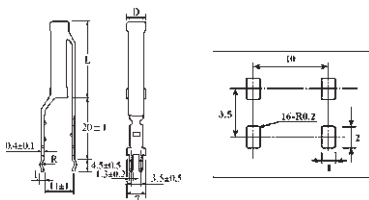

### "L" type terminal - TMOL

端片 MOR 电阻-L型端片 (TMOL)

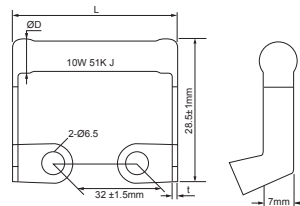

### Radial type - TMOR

端片 MOR 电阻-卧式 (TMOR)

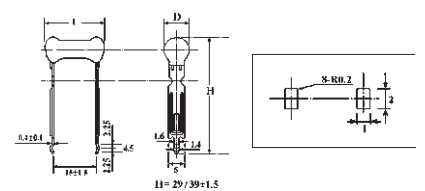

### Specification (性能)

Part No. 料号	Type 类型	Power Rating 功率 70°C	Dimension (尺寸)(mm)		Max. Working Voltage 最大工作电压	Max. Overload Voltage 最大过负荷电压	Resistance Range 阻值范围 (5%)
			L ± l	D ± l			
TMOV5W	TMOV-500	5W	20	7	500V	800V	10Ω ~ 10KΩ
TMOV7W	TMOV-700	7W	30	7	500V	800V	10Ω ~ 10KΩ
TMOLAW	TMOL-10W	10W	46 Max 最大	10 Max 最大	500V	800V	100Ω ~ 82KΩ
TMOR3W	TMOR-300	3W	16	6	350V	600V	10Ω ~ 10KΩ
TMOR5W	TMOR-500	5W	18	7	500V	800V	10Ω ~ 10KΩ

### Ordering Procedure (Example: TMOV 5W 5% 1KΩ B/B)

订购方式 (例如: TMOV 5W 5% 1KΩ B/B)

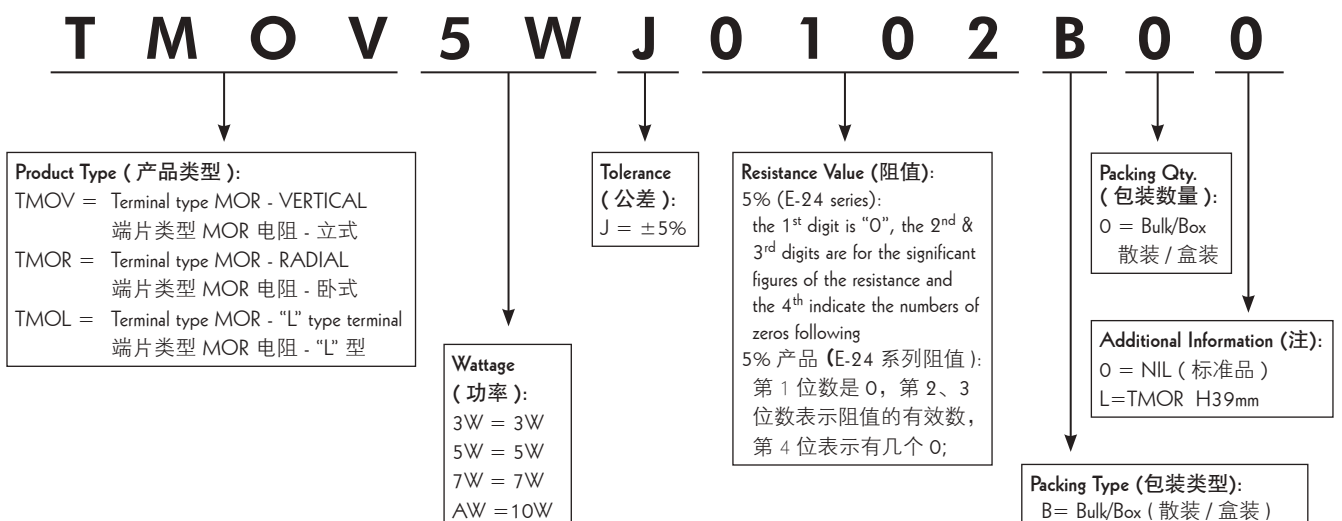

ZW Type (ZW 型)

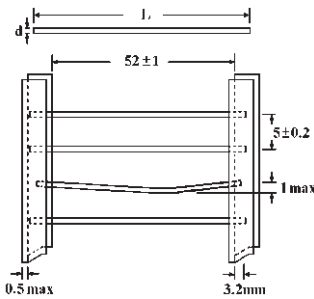

ZO Type (ZO 型)

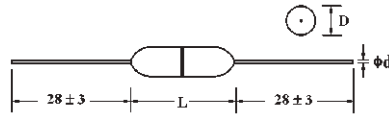

Body material (ZO type): Iron rod painted  
 本体材料 (ZO 型): 铁棒涂漆

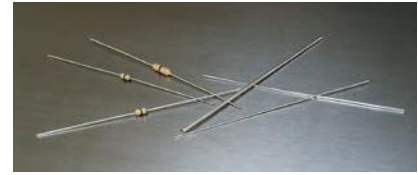

CFR Type (CFR 型)

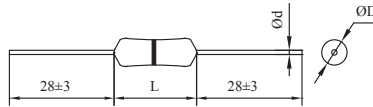

Body material (CFR type): Electrical grade, copper film ceramic rod.  
 本体材料 (CFR 型): 镀铜瓷棒

Part No. 料号	Type 类型	Dimension (尺寸) (mm)		Resistance Range 阻值范围 (≤mΩ)
		L ± 3	d ± 0.05	
ZWA0	ZW-A	60	0.45	50
ZWB0	ZW-B	60	0.54	50
ZWC0	ZW-C	60	0.65	50
ZWD0	ZW-D	60	0.75	50
ZWF0	ZW-F	60	1.00	50

Part No. 料号	Type 类型	Power Rating 功率 70°C	Dimension (尺寸) (mm)			Resistance Range 阻值范围 (≤mΩ)
			D±0.3	L	d ± 0.05	
ZO00W8	ZO-12	1/8W	1.8	3.2±0.2	0.45	10
ZO00W4	ZO-25	1/4W	2.1	6.0±0.5	0.54	10
CFR0W8	CFR-12	1/8W	1.9	3.3±0.3	0.45	50
CFR0W4	CFR-25	1/4W	2.2	6.5±1.0	0.54	50

Performance Specifications (性能)

Lead material	引线材料	Tin-plated copper (镀锡铜线)
Insulation resistance	绝缘阻值	Dry (干态) - 10,000 MΩ; Wet (湿态) - 100MΩ
Dielectric withstanding voltage	绝缘耐压	Atmospheric (正常气压) - 500V RMS; Reduced (减压) - 325V RMS
Rated current	额定电流	1/8W 70°C 1.5A; 1/4W 70°C 2.5A, derating to 0 AMPS at 150°C 1/8W 70°C 1.5A; 1/4W 70°C 2.5A, 150°C 时, 电流降低到 0A.

Ordering Procedure (Example: ZO 1/4W T/R-5,000)

订购方式 (例如: ZO 1/4W T/R-5,000)

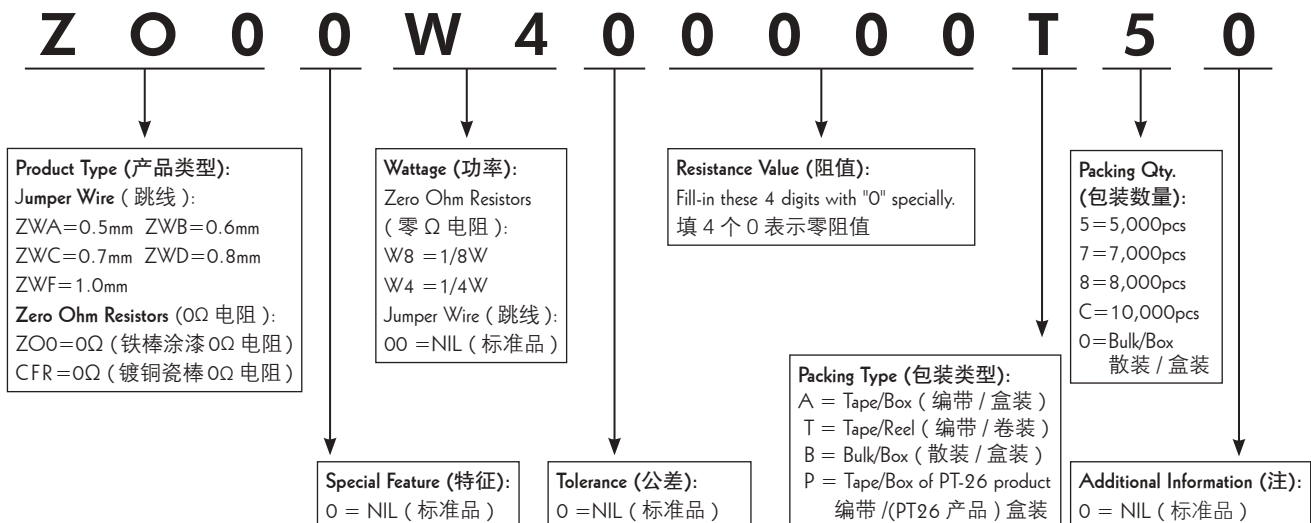

### Copper Plated Wire Type (CP) [铜包钢 (CP) 型]

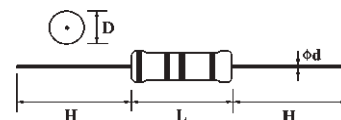

Part No. 料号	Type 类型	Power Rating 功率 70°C	Dimension (尺寸)(mm)				Max. Working Voltage 最大工作电压	Max. Overload Voltage 最大过负荷电压	Resistance Range 阻值范围
			D Max. D 最大	L Max. L 最大	d±0.02	H±3			
CP00W4	CP-25	1/4W	2.5	6.8	0.5	28/38	250V	500V	1Ω ~ 10MΩ
CP00S3	CP-33-S	1/3W	2.5	6.8	0.5	28/38	300V	600V	1Ω ~ 10MΩ
CP00W3	CP-33	1/3W	3	9	0.5	28	300V	600V	1Ω ~ 10MΩ
CP00S2	CP-50-S	1/2W	3	9	0.5	28	350V	700V	1Ω ~ 10MΩ

### Cutting Type (CO) [切割半成品型 (CO) 型]



Part No. 料号	Type 类型	Power Rating 功率 70°C	Dimension (尺寸)(mm)		Resistance Range 阻值范围
			D	L	
CO...W8	CO-12	1/8W	1.6 <sup>+0.10</sup> <sub>-0.00</sub>	3.2 ±0.10	1Ω ~ 10MΩ
CO...W4	CO-25	1/4W	2.1 <sup>+0.09</sup> <sub>-0.00</sub>	5.6 <sup>+0.10</sup> <sub>-0.20</sub>	1Ω ~ 10MΩ
CO...W4...A	CO-25-A	1/4W	2.1 <sup>+0.09</sup> <sub>-0.00</sub>	5.9 <sup>+0.10</sup> <sub>-0.15</sub>	1Ω ~ 10MΩ
CO...W4...B	CO-25-B	1/4W	2.1 <sup>+0.09</sup> <sub>-0.01</sub>	6.4 <sup>+0.10</sup> <sub>-0.15</sub>	1Ω ~ 10MΩ

• Cutting type resistors are produced without lead-wire and without coating  
切割型半成品型电阻无导线，无涂装

• Cap plated option: 1. Tin-plated 2. Nickel-Plated  
铁帽：1 镀锡 2 镀镍

### Ordering Procedure (Example: CPL 1/4W 5% H=38mm 10Ω T/B-5000)

订购方式 (例如: CPL 1/4W 5% H=38mm 10Ω T/B-5000)

C P L 0 W 4 J 0 1 0 0 A 5 0

**Special Feature (特征):**  
O = Standard (标准品)  
F = Flame retardant (阻燃型)  
I = Non-Inductive (无感型)

**Wattage (功率):**  
W8 = 1/8W  
W4 = 1/4W  
W3 = 1/3W

**Tolerance (公差):**  
G = ±2%  
J = ±5%  
K = ±10%

**Packing Type (包装类型):**  
A = Tape/Box (编带/盒装)  
T = Tape/Reel (编带/卷装)  
B = Bulk/Box (散装/盒装)  
"B" (B/B) is the only available packing for Cutting type ["B" (B/B) 只能用于切割型]

**Product Type (产品类型):**  
CPO = Cooper plated steel lead wire, (铜包钢导线) H=28mm  
CPL = Cooper plated steel lead wire, (铜包钢导线) H=38mm  
COT = Cutting type (Tin-plated Cap) [切割型 (镀锡铁帽)]  
CON = Cutting type (Nickel-plated Cap) [切割型 (镀镍铁帽)]

**Resistance Value (阻值):**  
**5%, 10% (E-24 series):** The 1<sup>st</sup> digit is "0", the 2<sup>nd</sup> & 3<sup>rd</sup> digits are for the significant figures of the resistance and the 4<sup>th</sup> indicate the number of zeros following  
5%, 10% 产品 (E-24 系列阻值): 第 1 位数是 0, 第 2、3 位数表示阻值的有效数, 第 4 位表示有几个 0;  
**2% (E-24 series):** The 1<sup>st</sup> digit is "0", the 2<sup>nd</sup> & 3<sup>rd</sup> digits are for the significant figures of the resistance and the 4<sup>th</sup> indicate the number of zeros following;  
2% 产品 (E-24 系列阻值): 第 1-3 位表示阻值的有效数, 第 4 位表示有几个 0.

**Packing Qty. (包装数量):**  
1 = 1,000pcs, 2 = 2,000pcs,  
3 = 3,000pcs, 4 = 4,000pcs,  
5 = 5,000pcs, A = 500pcs,  
B = 2,500pcs,  
0 = Bulk/Box (散装/盒装)

**Additional Information (注):**  
O = CP type (CP型),  
A = CO-25-A, B = CO-25-B

Feature (特性)

- This specification is applicable for CFR 1/4W, MFR1/4W, MOR 1/4W, MOR1WS, MOR2WS, KNP1WS, KNP2WS product only, other product (size), please consult factory for the available specification and drawing.
- 下图规格适用于 CFR 1/4W, MFR1/4W, MOR 1/4W, MOR1WS, MOR2WS, KNP1WS, KNP2WS. 其它产品的立式加工, 可洽询工厂以取得可生产的规格图样。

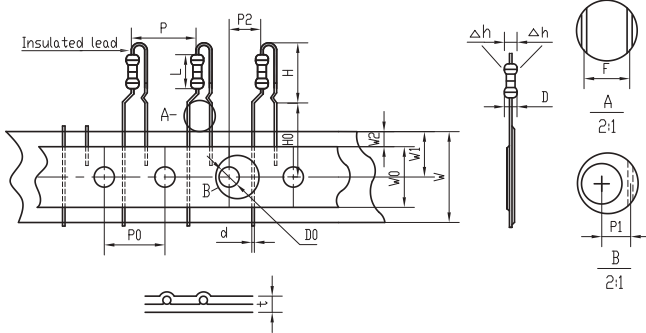

P<sub>0</sub> cumulative pitch error 1 mm / 20 pitch  
(注: P<sub>0</sub> 累积脚距误差 1.0mm / 20 脚距)

Max. (最大) Min. (最小)

Project (项目)	1/4W	1WS	2WS
Body diameter (D) 本体直径	2.5 Max.	3.5±0.5	4±0.5
Body length (L) 本体长度	6.8 Max.	9±1.0	12±1.0
Body height (H) 本体高度	12 Max.	19 Max.	21 Max.
Lead-wire diameter (d) 导线直径	0.54±0.05	0.65±0.05	0.65±0.05
Pitch of component (P) 零件间距	12.7±1	12.7±1	12.7±1
Feed hole pitch (P <sub>0</sub> ) 孔距	12.7±0.3	12.7±0.3	12.7±0.3
Hole center to lead (P <sub>1</sub> ) 中心测量	3.85±0.7	3.85±0.7	3.85±0.7
Hole center to body (P <sub>2</sub> ) 孔心至本体	6.35±1.3	6.35±1.3	6.35±1.3
Lead to lead distance (F) 两脚导线中心测量	5±1	5±1	5±1
Component alignment (Δh) 零件偏移	0±1	0±2	0±2
Tape width (W) 纸带宽度	18±1	18+1.0/-1.5	18+1.0/-1.5
Hole position (W <sub>1</sub> ) 孔位	9±0.5	9±0.5	9±0.5
Lead-wire clinch height (H <sub>0</sub> ) 导线固定端高度	16.5 Max.	16±0.5	16±0.5
Feed hole diameter (D <sub>0</sub> ) 孔径	4±0.3	4±0.3	4±0.3
Total tape thickness (t) 纸带总厚	0.5±0.2	0.5±0.2	0.5±0.2
Sticky tape width (W <sub>0</sub> ) 热熔胶带宽	12.5 Min.	12.5 Min.	12.5 Min.
Uncovered paper tape width (W <sub>2</sub> ) 纸带露出宽度	3.0 Max.	1.5 Max.	1.5 Max.

Ordering Procedure (Example: CFR 1/4W 5% 100KΩ T/B-2000 PANASERT Type)

订购方式 (例如: CFR 1/4W 5% 100K Ω T/B-2000 PANASERT 型)

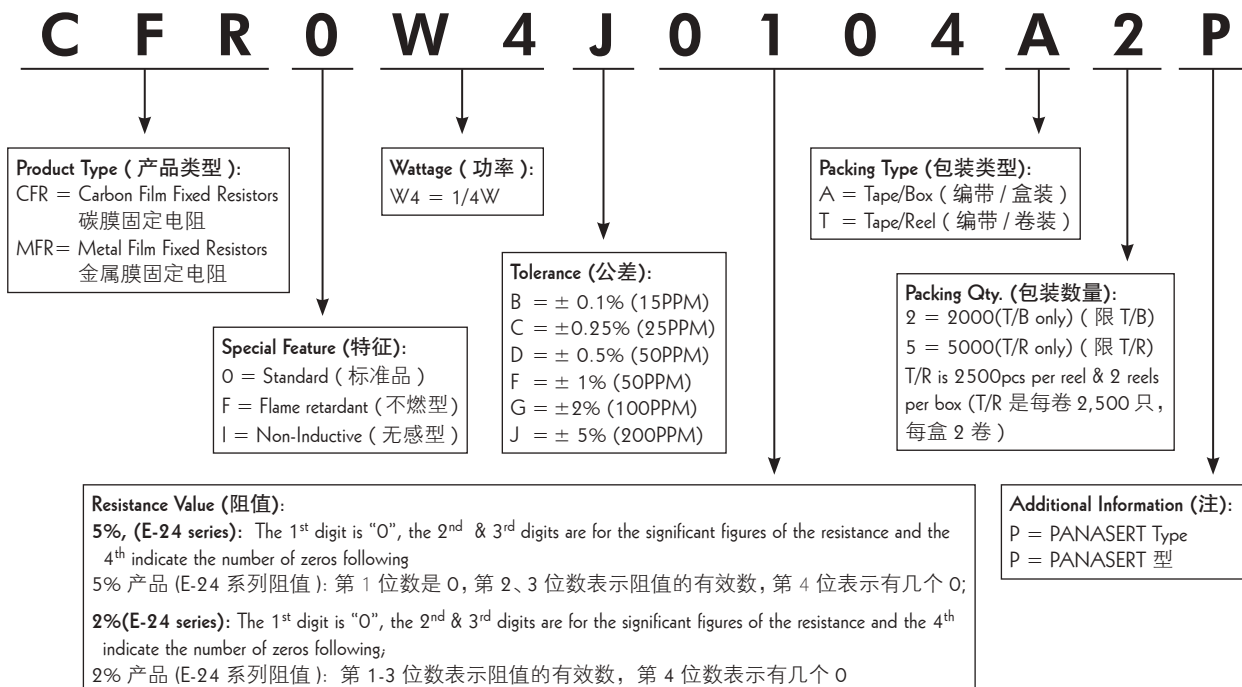

### Avisert (1) Type [Avisert (1) 型]

- This specification is applicable for CFR 1/4W & MFR 1/4W product only; other product (size), please consult factory for the available specification and drawing.
- 适用于CFR 1/4W 和 MFR 1/4 W 固定电阻。其它产品的立式加工，可洽询工厂以取得可生产的规格图样。

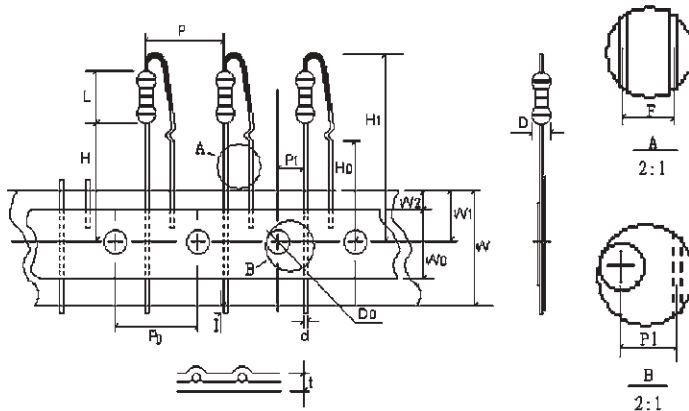

Max. (最大) Min. (最小)

Body diameter 本体直径	(D)	2.5 Max.
Body length 本体长度	(L)	6.8 Max.
Lead-wire diameter 导线直径	(d)	0.54±0.05
Pitch of component 零件间距	(P)	12.7±1
Feed hole pitch 孔距	(P <sub>0</sub> )	12.7±0.3
Hole center to lead 孔心至导线中心测量	(P <sub>1</sub> )	3.85±0.7
Lead to lead distance 两脚导线中心测量	(F)	5±1
Tape width 纸带宽度	(W)	18±1
Hole position 孔位	(W <sub>1</sub> )	9±0.5
Lead-wire clinch height 导线固定端高度	(H <sub>0</sub> )	16.5 Max.
Component height 零件高度	(H <sub>1</sub> )	32.25 Max.
Lead wire protrusion 导线伸出长度	(l)	1.0 Max.
Feed hole diameter 孔径	(D <sub>0</sub> )	4±0.3
Total tape thickness 纸带总厚	(t)	0.5±0.2
Sticky tape width 胶带宽度	(W <sub>0</sub> )	12.5 Min.
Uncovered paper tape width 纸带露出宽度	(W <sub>2</sub> )	3.0 Max.
Height of component from tape center 零件至纸带中间的高度	(H)	17.3 ± 0.5

### Avisert (2) Type [Avisert (2) 型]

- This specification is applicable for CFR 1/8W & MFR 1/8W product only; other product (size), please consult factory for the available specification and drawing.
- 适用于 CFR 1/8W 和 MFR 1/8W 固定电阻。其它产品的立式加工，可洽询工厂以取得可生产的规格图样。

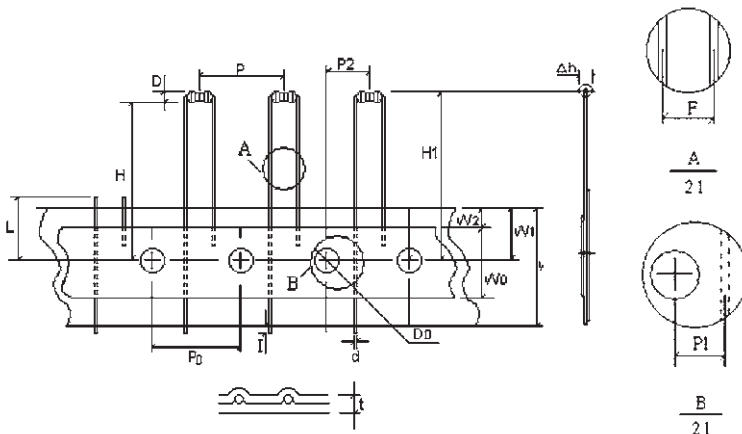

Max. (最大) Min. (最小)

Body diameter 本体直径	(D)	2.5 Max.
Lead-wire diameter 导线直径	(d)	0.54±0.05
Pitch of component 零件间距	(P)	12.7±1
Feed hole pitch 孔距	(P <sub>0</sub> )	12.7±0.3
Hole center to lead 中心测量	(P <sub>1</sub> )	3.85±0.7
Lead to lead distance 两脚导线中心测量	(F)	5±1
Component alignment 零件偏移	(Δh)	0 ± 1
Tape width 纸带宽度	(W)	18±1
Hole position 孔位	(W <sub>1</sub> )	9±0.5
Lead wire clinch height 导线固定端高度	(H)	21.0 Max.
Component height 零件高度	(H <sub>1</sub> )	32.25 Max.
Lead wire protrusion 导线伸出长度	(l)	1.0 Max.
Feed hole diameter 孔径	(D <sub>0</sub> )	4±0.3
Total tape thickness 纸带总厚	(t)	0.5±0.2
Sticky tape width 热熔胶带宽	(W <sub>0</sub> )	12.5 Min.
Uncovered paper tape width 纸带露出宽度	(W <sub>2</sub> )	3.0 Max.
Length of snipped lead 剪脚长度	(L)	11.0 Max.
Hole center to component center 孔心至零件中心距离	(P <sub>2</sub> )	6.35 ± 1.3

Remark: P<sub>0</sub> cumulative pitch error 1.0mm/20pitch (P<sub>0</sub> 累积脚距误差脚距 1.0mm / 20 脚距)

P<sub>1</sub> to be measured at bottom of clinch (P<sub>1</sub> 测量固定端底部)

t: ground paper 0.5 ± 0.1mm (t: 纸带底厚 0.5 ± 0.1mm)

**Avisert (3) Type [Avisert (3) 型]**

- This specification is applicable for CFR 1/4W, MFR1/4W, MOR 1/4W, MOR1WS, MOR2WS, KNP1WS, KNP2WS product only, other product (size), please consult factory for the available specification and drawing.
- 适用于 CFR 1/4W, MFR1/4W, MOR 1/4W, MOR1WS, MOR2WS, KNP1WS, KNP2WS 其它产品的立式加工, 可洽询工厂以取得可生产的规格图样。

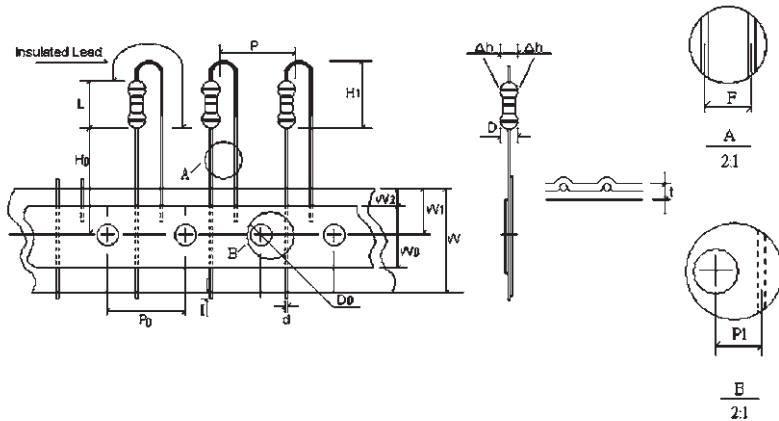

Remark: P<sub>0</sub> cumulative pitch error 1.0mm/20pitch (注: P<sub>0</sub> 累积脚距误差 1.0mm / 20 脚距)

Max. (最大) Min. (最小)

Body diameter 本体直径	(D)	1/8W: 2.0 Max. 1/4W: 2.5 Max.
Body length 本体长度	(L)	1/8W: 4.2 Max. 1/4W: 6.8 Max.
Body height 本体高度	(H)	1/8W: 7.0 Max. 1/4W: 10.0 Max.
Lead wire diameter 导线直径	(d)	1/8W: 0.45 ± 0.05 1/4W: 0.54 ± 0.05
Pitch of component 零件间距	(P)	12.7 ± 1
Lead to lead distance 两脚导线中心测量	(F)	1/8W: 2.5 ± 1 1/4W: 5 ± 1
Feed hole pitch 孔距	(P <sub>0</sub> )	12.7 ± 0.3
Hole center to lead 孔心到导线中心测量	(P <sub>1</sub> )	3.85 ± 0.7
Component alignment 零件偏移	(Δh)	0 ± 0.1
Paper tape width 纸带宽度	(W)	18 ± 1
Hold down tape width 孔至下纸带宽度	(W <sub>0</sub> )	12.5 Min
Hole position 孔位	(W <sub>1</sub> )	9 ± 0.5
Hold down tape position 孔至下纸带位置	(W <sub>2</sub> )	3 Max.
Lead wire clinch height 导线固定端高度	(H <sub>0</sub> )	16.5 Max.
Length of snipped lead 剪脚长度	(H <sub>1</sub> )	11.0 Max.
Lead wire protrusion 导线伸出长度	(l)	1.0 Max.
Feed hole diameter 孔径	(d <sub>0</sub> )	4 ± 0.3
Total paper tape thickness 纸带总厚	(t)	0.5 ± 0.2

**Ordering Procedure (Example: MFR 1/8W 1% 50PPM 221Ω T/R-5000 Avisert 3 Type)**

订购方式 (例如: MFR 1/8W 1% 50PPM 221Ω T/R-5000 Avisert 3型)

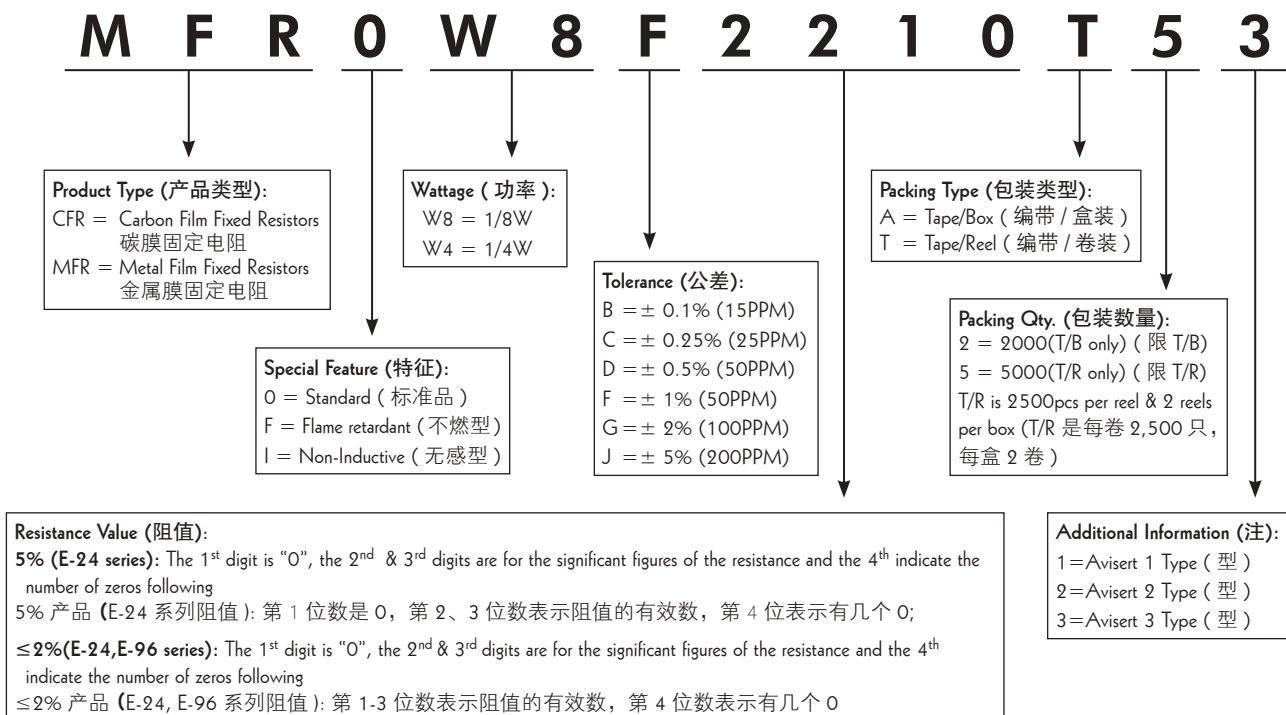



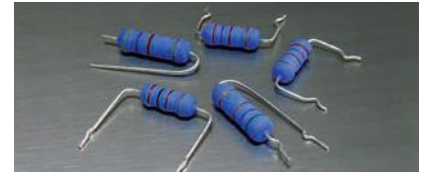

### F Forming Type (F 型)

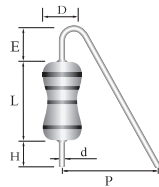

F Type (F 型)



F1 Type (F1 型)



F2 Type (F2 型)



F3 Type (F3 型)

### Dimension (尺寸) (mm)

Power Rating 功率	L Max. L 最大	D Max. D 最大	$d \pm 0.05$	$P \begin{matrix} +1 \\ -3 \end{matrix}$	$H \pm 1$	$E \pm 0.5$
1 W (2W-S)	12	5.0	0.65	8	6	2.5
2 W (3W-S)	16	5.5	0.70	8	6	2.5

• Above specification given for recommendation only, please consult factory for special required specification (以上规格仅供参考, 其它可提供的规格请咨询工厂)

### Ordering Procedure (Example: CFR 2W-S 5% 100Ω B/B F1 Type)

订购方式 (例如: CFR 2W-S 5% 100Ω B/B F1 型)

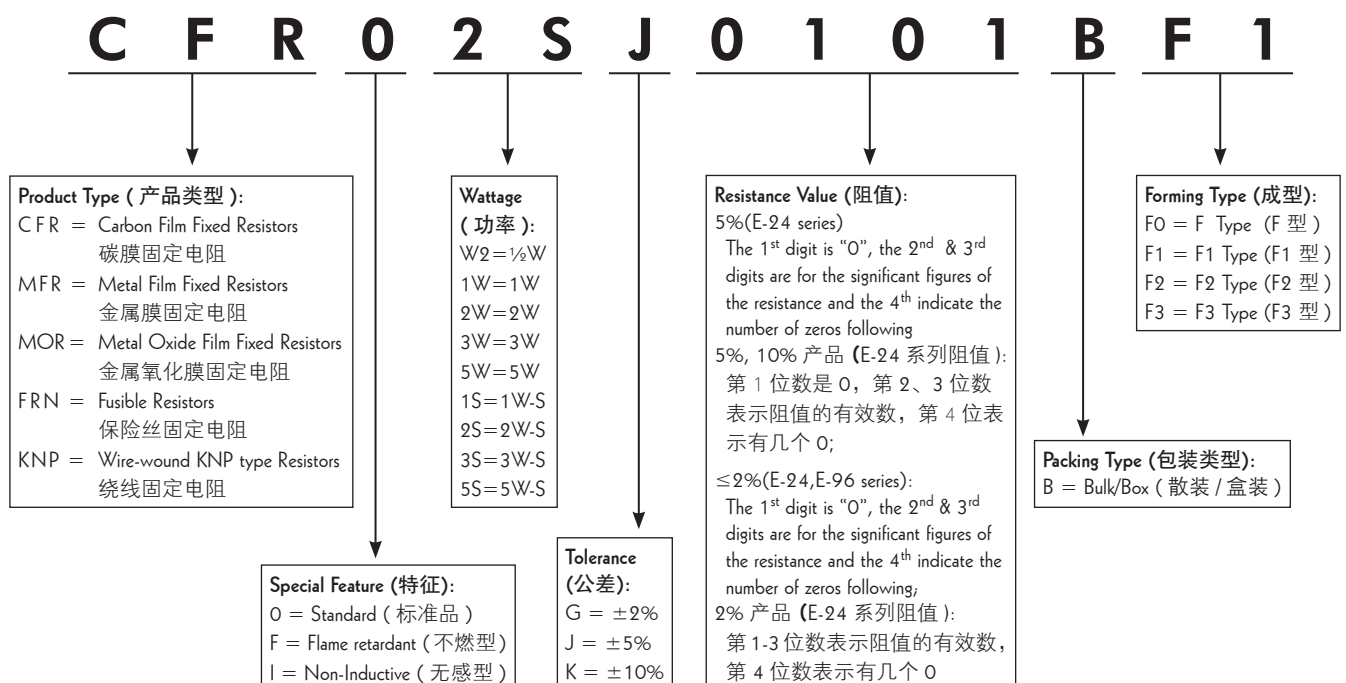

M Forming Type (M 型)

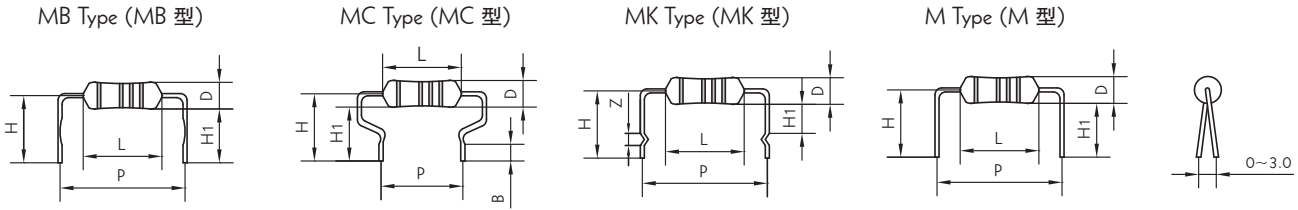

Normal Size (正常尺寸)

Power Rating 功率 70°C	Dimension (尺寸)(mm)				
	D Max. 最大	L Max. 最大	H±2	P±1.5	d±0.05
1/2W	4	10	14	13	0.54
1W	5	12	14	15	0.65
2W	5.5	16	18	20	0.70
3W	6.5	17.5	20	25	0.75
5W	8.5	26	20	31	0.75

Small Size (小尺寸)

Power Rating 功率 70°C	Dimension (尺寸)(mm)				
	D Max. D 最大	L Max. L 最大	H±2	P±1.5	d±0.05
1W	4	10	14	13	0.65
2W	5	12	14	15	0.65
3W	5.5	16	18	20	0.75
5W	8	25	22	31	0.75

• Above specification given for recommendation only, please consult factory for special required specification ( 以上规格仅供参考, 其它可提供的规格请咨询工厂 )

Ordering Procedure (Example: MOR 1W-S 5% 10Ω B/B M Type with flattened lead wire)

订购方式 (例如: MOR 1W-S 5% 10Ω B/B M 型导线打扁)

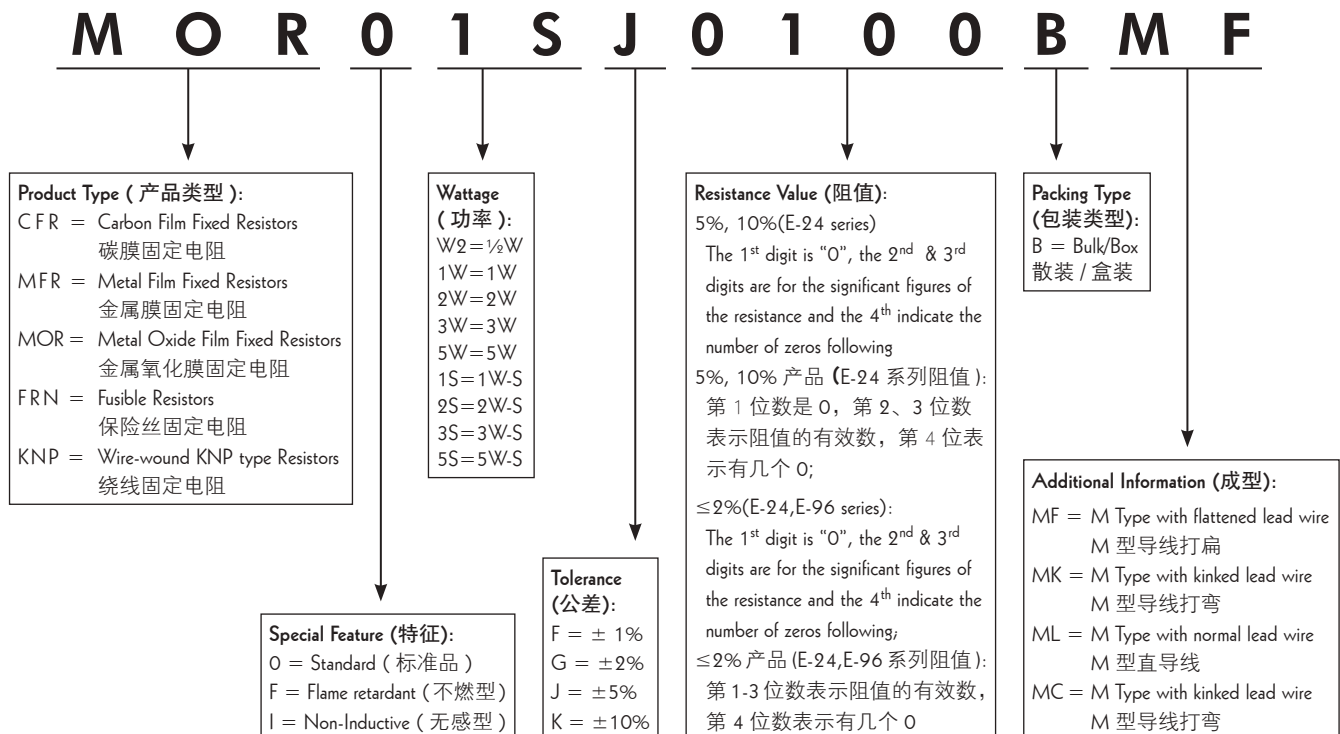

### Tape in Box Packing (Ammo Pack) (编带盒装)

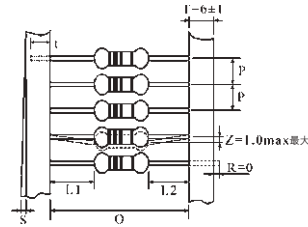
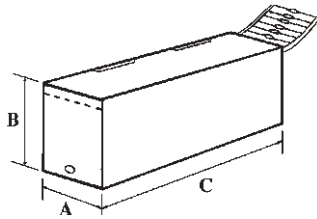

\*L1-L2=1.0 Max. 最大  
 ZW: 0  
 \*\*S=0.5 Max. 最大  
 PT-26: 0.8 Max. 最大

Part No. 料号	Type 类型	Dimension of T/B (尺寸)(mm)					Qty./Box 数量/盒
		O	P	A±5	B±5	C±5	
<b>Carbon Film Fixed Resistors (碳膜固定电阻)</b>							
CFROW8	CFR-12	52 ± 1	5 ± 0.3	75	70	255	5,000
CFROS4	CFR-25-S	52 ± 1	5 ± 0.3	75	70	255	5,000
CFROW4	CFR-25	52 ± 1	5 ± 0.3	75	98	255	5,000
CFROU2	CFR-50-SS	52 ± 1	5 ± 0.3	75	116	255	5,000
CFROS2	CFR-50-S	52 ± 1	5 ± 0.3	75	70	255	2,000
CFROW2	CFR-50	52 ± 1	5 ± 0.3	75	45	255	1,000
CFR01S	CFR-100-S	58 ± 1	5 ± 0.3	80	82	255	1,000
CFR01W	CFR-100	65 ± 5	10 ± 0.5	90	88	255	1,000
CFR02S	CFR-200-S	65 ± 5	10 ± 0.5	90	88	255	1,000
CFR02W	CFR-200	65 ± 5	10 ± 0.5	90	88	255	500
CFR03S	CFR-300-S	65 ± 5	10 ± 0.5	90	88	255	500
<b>Metal Film Fixed Resistors (金属膜固定电阻)</b>							
MFLOW8	MF-12	52 ± 1	5 ± 0.3	75	70	255	5,000
MFR0S4	MF-25-S	52 ± 1	5 ± 0.3	75	70	255	5,000
MFLOW4	MF-25	52 ± 1	5 ± 0.3	75	98	255	5,000
MFR004	MF-40-SS	52 ± 1	5 ± 0.3	75	70	255	5,000
MFR0U2	MF-50-SS	52 ± 1	5 ± 0.3	75	116	255	5,000
MFR0S2	MF-50-S	52 ± 1	5 ± 0.3	75	70	255	2,000
MFLOW2	MF-50	52 ± 1	5 ± 0.3	75	45	255	1,000
MFR006	MF-60-S	52 ± 1	5 ± 0.3	75	116	255	5,000
MFR01W	MF-100	58 ± 1	5 ± 0.3	80	82	255	1,000
MFR02W	MF-200	65 ± 5	10 ± 0.5	90	88	255	1,000
MFR03W	MF-300	65 ± 5	10 ± 0.5	90	88	255	500
<b>Metal Oxide Film Fixed Resistors (金属氧化膜固定电阻)</b>							
MOR0W4	MOR-25	52 ± 1	5 ± 0.3	75	116	255	5,000
MOR0S2	MOR-50-S	52 ± 1	5 ± 0.3	75	116	255	5,000
MOR0W2	MOR-50	52 ± 1	5 ± 0.3	75	70	255	1,000
MOR01S	MOR-100-S	58 ± 1	5 ± 0.3	80	70	255	1,000
MOR01W	MOR-100	58 ± 1	5 ± 0.3	80	82	255	1,000
MOR02S	MOR-200-S	58 ± 1	5 ± 0.3	80	82	255	1,000
MOR02W	MOR-200	65 ± 1	10 ± 0.5	90	119	255	1,000
MOR03S	MOR-300-S	65 ± 1	10 ± 0.5	90	119	255	1,000
MOR03W	MOR-300	65 ± 5	10 ± 0.5	90	88	255	500
MOR05U	MOR-500-SS	65 ± 5	10 ± 0.5	90	88	255	500
MOR05S	MOR-500-S	90 ± 5	10 ± 0.5	115	124	500	500
<b>Fusible Resistors (保险丝电阻)</b>							
FRNOW4	FRN-25	52 ± 1	5 ± 0.3	75	116	255	5,000
FRNOW2	FRN-50	52 ± 1	5 ± 0.3	80	70	255	2,000
FRN01W	FRN-100	58 ± 1	5 ± 0.3	80	70	255	1,000
FRN02W	FRN-200	58 ± 1	5 ± 0.3	80	82	255	1,000
FRN03W	FRN-300	65 ± 5	10 ± 0.5	90	119	255	1,000

Part No. 料号	Type 类型	Dimension of T/B (尺寸) (mm)					Qty./Box 数量 / 盒
		O	P	A±5	B±5	C±5	
<b>Wire-wound Fixed Resistors (绕线固定电阻)</b>							
KNP0W2	KNP-50	58±1	5±0.3	75	70	255	1,000
KNP01S	KNP-100-S	58±1	5±0.3	80	70	255	1,000
KNP01W	KNP-100	58±1	5±0.5	80	82	255	1,000
KNP02S	KNP-200-S	58±1	5±0.5	80	82	255	1,000
KNP02W	KNP-200	65±5	10±0.5	90	119	255	1,000
KNP03S	KNP-300-S	65±5	10±0.5	90	119	255	1,000
KNP03W	KNP-300	65±5	10±0.5	90	88	255	500
KNP05S	KNP-500-S	65±5	10±0.5	90	88	255	500
<b>Jumper Wires &amp; Zero Ohm Resistors (跳线和零欧姆固定电阻)</b>							
ZWA0	ZW-A	52±1	5±0.3	75	98	255	10,000
ZWB0	ZW-B	52±1	5±0.3	75	116	255	10,000
ZWC0	ZW-C	52±1	5±0.3	75	116	255	8,000
ZWD0	ZW-D	52±1	5±0.3	75	116	255	8,000
ZWF0	ZW-F	52±1	5±0.3	75	116	255	7,000
ZO00W8	ZO-12	52±1	5±0.3	75	70	255	5,000
ZO00W4	ZO-25	52±1	5±0.3	75	98	255	5,000
<b>PT-26 Type (PT-26 类型)</b>							
CFROW8	CFR-12	26 <sup>+1.5</sup> <sub>-.1</sub>	5±0.5	50	66	255	5,000
CFROS4	CFR-25-S	26 <sup>+1.5</sup> <sub>-.1</sub>	5±0.5	50	66	255	5,000
CFROW4	CFR-25	26 <sup>+1.5</sup> <sub>-.0</sub>	5±0.5	50	100	255	5,000
CFROU2	CFR-50-SS	26 <sup>+1.5</sup> <sub>-.0</sub>	5±0.5	50	100	255	4,000
MFLOW8	MF-12	26 <sup>+1.5</sup> <sub>-.1</sub>	5±0.5	50	66	255	5,000
MFR0S4	MF-25-S	26 <sup>+1.5</sup> <sub>-.1</sub>	5±0.5	50	66	255	5,000
MFLOW4	MF-25	26 <sup>+1.5</sup> <sub>-.0</sub>	5±0.5	50	100	255	5,000
MFR0U2	MF-50-SS	26 <sup>+1.5</sup> <sub>-.0</sub>	5±0.5	50	100	255	4,000
MFR006	MF-60-S	26 <sup>+1.5</sup> <sub>-.0</sub>	5±0.5	50	100	255	4,000
<b>Metal Glazed Film Fixed Resistors (金属玻璃釉膜固定电阻)</b>							
MGR0W4	MGR25	52±1	5±0.3	75	116	255	4000
MGR0W2	MGR-50	52±1	5±0.3	75	70	255	1000
MGR01W	MGR-100	58±1	5±0.3	80	82	255	1000
MGR02W	MGR-200	65±5	10±0.5	90	119	255	1000
MGR03W	MGR-300	65±5	10±0.5	90	88	255	500
MGR0U2	MGR-50-SS	52±1	5±0.3	75	116	255	4000
MGR0S2	MGR-50-S	52±1	5±0.3	75	45	255	1000
MGR01U	MGR-100-SS	52±1	5±0.3	75	70	255	1000
MGR01S	MGR-100-S	58±1	5±0.3	80	82	255	1000
MGR02U	MGR-200-SS	58±1	5±0.3	80	82	255	1000
MGR02S	MGR-200-S	58±1	5±0.3	80	82	255	1000
MGR03U	MGR-300-SS	58±1	5±0.3	80	82	255	1000
MGR03S	MGR-300-S	65±5	10±0.5	90	119	255	1000

### Tape in Reel (编带卷装)

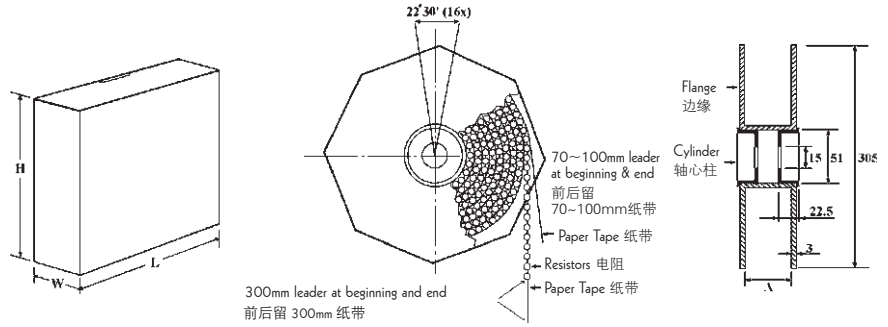

Part No. 料号	Type 类型	Dimension of T/R (尺寸) (mm)				Qty./Box 数量 / 盒
		A	W±5	H±5	L±5	
<b>Carbon Film Fixed Resistors (碳膜固定电阻)</b>						
CFR0W8	CFR-12	73±2	85	295	293	5,000
CFR0S4	CFR-25-S	73±2	85	295	293	5,000
CFR0W4	CFR-25	73±2	85	295	293	5,000
CFR0U2	CFR-50-SS	73±2	85	295	293	5,000
CFR0S2	CFR-50-S	73±2	85	295	293	4,000
CFR0W2	CFR-50	73±2	85	295	293	4,000
CFR01S	CFR-100-S	73±2	85	295	293	2,500
CFR0IW	CFR-100	80±5	95	295	293	1,000
CFR02S	CFR-200-S	80±5	95	295	293	1,000
CFR02W	CFR-200	80±5	95	295	293	1,000
CFR03S	CFR-300-S	80±5	95	295	293	1,000
<b>Metal Film Fixed Resistors (金属膜固定电阻)</b>						
MFROW8	MF-12	73±2	85	295	293	5,000
MFROS4	MF-25-S	73±2	85	295	293	5,000
MFROW4	MF-25	73±2	85	295	293	5,000
MFRO04	MF-40-SS	73±2	85	295	293	5,000
MFROU2	MF-50-SS	73±2	85	295	293	5,000
MFROS2	MF-50-S	73±2	85	295	293	4,000
MFROW2	MF-50	73±2	85	295	293	4,000
MFRO06	MF-60-S	73±2	85	295	293	5,000
MFROIW	MF-100	73±2	85	295	293	2,500
MFRO2W	MF-200	80±5	95	295	293	1,000
MFRO3W	MF-300	80±5	95	295	293	1,000
<b>Metal Oxide Film Fixed Resistors (金属氧化膜固定电阻)</b>						
MOR0W4	MOR-25	73±2	85	295	293	5,000
MOR0S2	MOR-50-S	73±2	85	295	293	5,000
MOR0W2	MOR-50	73±2	85	295	293	3,500
MOR01S	MOR-100-S	73±2	85	295	293	2,500
MOR0IW	MOR-100	73±2	85	295	293	2,500
MOR02S	MOR-200-S	73±2	85	295	293	2,500
MOR02W	MOR-200	80±5	95	295	293	1,000
MOR03S	MOR-300-S	80±5	95	295	293	1,000
MOR03W	MOR-300	80±5	95	295	293	1,000
MOR05U	MOR-500-SS	80±5	95	295	293	1,000

Part No. 料号	Type 类型	Dimension of T/R (尺寸) (mm)				Qty./Box 数量 / 盒
		A	W±5	H±5	L±5	
<b>Fusible Resistors ( 保险丝电阻 )</b>						
FRNOW4	FRN-25	73±2	85	295	293	5,000
FRNOW2	FRN-50	73±2	85	295	293	4,000
FRNO1W	FRN-100	73±2	85	295	293	2,500
FRNO2W	FRN-200	73±2	85	295	293	2,500
FRNO3W	FRN-300	80±5	95	295	293	1,000
<b>Wire-wound Fixed Resistors ( 绕线固定电阻 )</b>						
KNPOW2	KNP-50	73±2	85	295	293	2,500
KNPO1S	KNP-100-S	73±2	85	295	293	2,500
KNPO1W	KNP-100	73±2	85	295	293	2,500
KNPO2S	KNP-200-S	73±2	85	295	293	2,500
KNPO2W	KNP-200	80±5	95	295	293	1,000
KNPO3S	KNP-300-S	80±5	95	295	293	1,000
KNPO3W	KNP-300	80±5	95	295	293	1,000
KNPO5S	KNP-500-S	80±5	95	295	293	1,000
<b>Jumper Wires &amp; Zero-Ohm Resistors ( 跳线和零欧姆固定电阻 )</b>						
ZWA0	ZW-A	73±2	85	295	293	10,000
ZWB0	ZW-B	73±2	85	295	293	10,000
ZO0W8	ZO-12	73±2	85	295	293	5,000
ZO0W4	ZO-25	73±2	85	295	293	5,000

• Taping dimension are the same as Tape/Box packing ( 纸带尺寸与编带盒装尺寸相同 )

### Bulk in Box Packing (散装盒装)

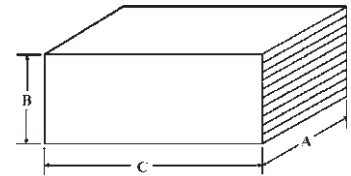
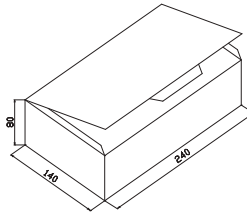

Part No. 料号	Type 类型	Dimension of Bulk/Box (内盒尺寸) (mm)			Qty. of Bag/Box 袋数量 / 盒数量
		A±5	B±5	C±5	
<b>Carbon Film Fixed Resistors (碳膜固定电阻)</b>					
CFR0W8	CFR-12	140	80	240	1,000 / 20,000
CFR0S4	CFR-25-S	140	80	240	1,000 / 20,000
CFR0W4	CFR-25	140	80	240	500 / 10,000
CFR0U2	CFR-50-SS	140	80	240	250 / 10,000
CFR0S2	CFR-50-S	140	80	240	500 / 8,000
CFR0W2	CFR-50	140	80	240	250 / 5,000
CFR01S	CFR-100-S	140	80	240	100 / 2,500
CFR01W	CFR-100	140	80	240	100 / 1,500
CFR02S	CFR-200-S	140	80	240	100 / 1,500
CFR02W	CFR-200	140	80	240	100 / 1,000
CFR03S	CFR-300-S	140	80	240	100 / 1,000
<b>Metal Film Fixed Resistors (金属膜固定电阻)</b>					
MFR0W8	MF-12	140	80	240	1,000 / 20,000
MFR0S4	MF-25-S	140	80	240	1,000 / 20,000
MFR0W4	MF-25	140	80	240	500 / 10,000
MFR004	MF-40-SS	140	80	240	1,000 / 20,000
MFR0U2	MF-50-SS	140	80	240	500 / 10,000
MFR0S2	MF-50-S	140	80	240	500 / 8,000
MFR0W2	MF-50	140	80	240	250 / 2,000
MFR006	MF-60-S	140	80	240	500 / 10,000
MFR01W	MF-100	140	80	240	100 / 2,500
MFR02W	MF-200	140	80	240	100 / 1,500
MFR03W	MF-300	140	80	240	100 / 1,500
<b>Metal Oxide Film Fixed Resistors (金属氧化膜固定电阻)</b>					
MOR0W4	MOR-25	140	80	240	250 / 10,000
MOR0S2	MOR-50-S	140	80	240	250 / 10,000
MOR0W2	MOR-50	140	80	240	200 / 4,000
MOR01S	MOR-100-S	140	80	240	200 / 4,000
MOR01W	MOR-100	140	80	240	100 / 2,500
MOR02S	MOR-200-S	140	80	240	100 / 2,500
MOR02W	MOR-200	140	80	240	100 / 1,500
MOR03S	MOR-300-S	140	80	240	100 / 1,500
MOR03W	MOR-300	140	80	240	100 / 1,000
MOR05U	MOR-500-SS	140	80	240	100 / 1,000
MOR05S	MOR-500-S	140	80	240	25 / 400
MOR05W	MOR-500	140	80	240	25 / 400
MOR07W	MOR-700	140	80	240	25 / 300

Part No. 料号	Type 类型	Dimension of Bulk/Box (内盒尺寸) (mm)			Qty. of Bag/Box 袋数量 / 盒数量
		A±5	B±5	C±5	
<b>Fusible Resistors ( 保险丝电阻 )</b>					
FRN0W4	FRN-25	140	80	240	250 / 10,000
FRN0W2	FRN-50	140	80	240	250 / 8,000
FRN01W	FRN-100	140	80	240	200 / 4,000
FRN02W	FRN-200	140	80	240	100 / 2,500
FRN03W	FRN-300	140	80	240	100 / 1,500
<b>Wire-wound Fixed Resistors ( 绕线固定电阻 )</b>					
KNP0W2	KNP-50	140	80	240	250 / 5,000
KNP01S	KNP-100-S	140	80	240	200 / 4,000
KNP01W	KNP-100	140	80	240	100 / 2,500
KNP02S	KNP-200-S	140	80	240	100 / 2,500
KNP02W	KNP-200	140	80	240	100 / 1,500
KNP03S	KNP-300-S	140	80	240	100 / 1,500
KNP03W	KNP-300	140	80	240	100 / 1,000
KNP05S	KNP-500-S	140	80	240	25 / 400
KNP05W	KNP-500	140	80	240	25 / 400
<b>Zero-Ohm Resistors ( 零欧姆固定电阻 )</b>					
ZO00W8	ZO-12	140	80	240	1,000 / 20,000
ZO00W4	ZO-25	140	80	240	500 / 10,000
CFR00W8	CFR-12	140	80	240	1,000 / 20,000
CFR00W4	CFR-25	140	80	240	500 / 10,000



### Feature (特性)

- Self-extinguishing 完全不可燃
- Extremely small & sturdy mechanically safe 体积小且坚固安全
- Non-Inductive type available 无感也可提供
- Excellent flame & moisture resistance 卓越抗湿性
- Too low or too high values on Wire-wound & Power-film type can be supplied on a case to case basis 过高或过低阻值，绕线或切割型都可以特别提供

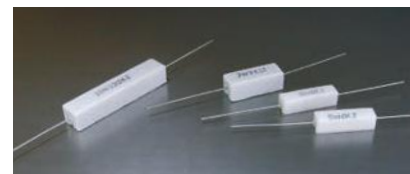

### Derating Curve (降功率曲线)

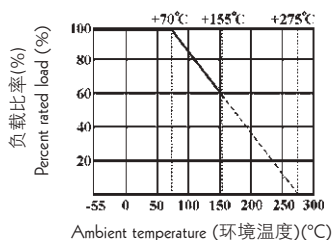

### Heat Rise Chart (表面温升)

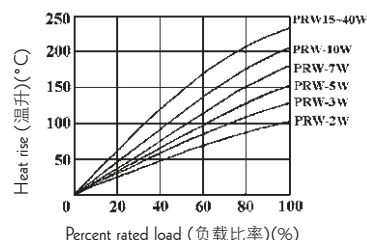

### Axial Leaded Type - PRW Series (轴式导线型-PRW系列)

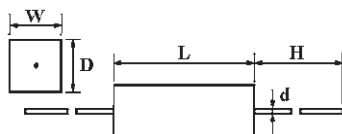

Part No. 料号	Type 类型	Dimension (尺寸)(mm)					Resistance Range 阻值范围	
		W ± 1	D ± 1	L ± 1	H	d ± 0.05	Wire-wound 绕线型	Power Film 切割型
PRW01W	PRW-1W	6	6	13.5	25±3	0.65	0.1Ω~20Ω	21Ω~100KΩ
PRW02W	PRW-2W	7	7	18	28±5	0.70	0.1Ω~27Ω	28Ω~120KΩ
PRW03W	PRW-3W	8	8	22	32±5	0.70	0.1Ω~39Ω	40Ω~150KΩ
PRW05W	PRW-5W	10	9	22	35±5	0.75	0.1Ω~47Ω	48Ω~150KΩ
PRW07W	PRW-7W	10	9	35	35±5	0.75	0.1Ω~680Ω	681Ω~200KΩ
PRW0AW	PRW-10W	10	9	49	35±5	0.75	0.1Ω~910Ω	911Ω~200KΩ
PRW0FW	PRW-15W	12.5	11.5	49	35±5	0.75	1Ω ~ 1KΩ	1.1KΩ~200KΩ
PRW020	PRW-20W	14.5	13.5	60	35±5	0.75	2Ω ~ 1.2KΩ	1.3KΩ~200KΩ
PRW025	PRW-25W	14.5	13.5	64	35±5	0.75	2Ω ~ 1.2KΩ	1.3KΩ~200KΩ

### Axial Leaded Type - PRWC Series (轴式导线型-PRW系列)

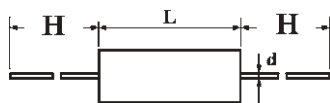

Part No. 料号	Type 类型	Dimension (尺寸)(mm)					Resistance Range 阻值范围	
		W ± 1	D ± 1	L ± 1	H	d ± 0.05	Wire-wound 绕线型	Power Film 切割型
PRWC3W	PRWC-3W	6	6	20	28 ± 5	0.70	1Ω~27Ω	28Ω~120KΩ
PRWC5W	PRWC-5W	6	6	25	35 ± 5	0.75	1Ω~100Ω	101Ω~150KΩ
PRWC7W	PRWC-7W	9	9	25	35 ± 5	0.75	1Ω~100Ω	101Ω~150KΩ

### Axial Leaded Type - PRWA Series (轴式导线型-PRWA系列)

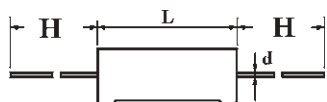

Part No. 料号	Type 类型	Dimension (尺寸)(mm)					Resistance Range 阻值范围	
		W ± 1	D ± 1	L ± 1	H	d ± 0.05	Wire-wound 绕线型	Power Film 切割型
PRWA2W	PRWA-2W	7	7	18	28 ± 5	0.70	0.1Ω~27Ω	28Ω~120KΩ
PRWA5W	PRWA-5W	10	9	22	35 ± 5	0.75	0.1Ω~47Ω	48Ω~150KΩ
PRWA7W	PRWA-7W	10	9	35	35 ± 5	0.75	0.1Ω~680Ω	681Ω~200KΩ
PRWAAW	PRWA-10W	10	9	49	35 ± 5	0.75	0.1Ω~910Ω	911Ω~200KΩ

Radial Leaded Type-PRM series (立式导线型-PRM系列)

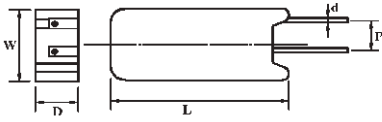

PRM2W PRM3W PRM5W PRMA-5W PRMP-5W  
PRMP-7W PRMP-15W Leads centered (居中)

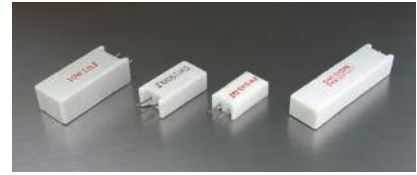

Part No. 料号	Type 类型	Dimension (尺寸)(mm)					Resistance Range 阻值范围	
		W ± 1	D ± 1	L ± 1	P ± 1	d ± 0.05	Wire-wound 绕线型	Power Film 切割型
PRM02W	PRM-2W	11.5	7.5	20	5	0.70	0.1Ω~27Ω	28Ω~120KΩ
PRM03W	PRM-3W	12.5	8.5	25	5	0.70	0.1Ω~39Ω	40Ω~150KΩ
PRM05W	PRM-5W	12.5	9	25	5	0.75	0.1Ω~47Ω	48Ω~150KΩ
PRM07W	PRM-7W	12.5	9	38	5	0.75	0.1Ω~680Ω	681Ω~200KΩ
PRM0AW	PRM-10W	12.5	9	50	5	0.75	0.1Ω~910Ω	911Ω~200KΩ
PRMA5W	PRMA-5W	12.5	9	25	7.5	0.80	0.1Ω~47Ω	48Ω~100KΩ
PRMAAW	PRMA-10W	16	12	35	7.5	0.80	0.1Ω~560Ω	561Ω~100KΩ
PRMB7W	PRMB-7W	12.5	9	38	5	0.80	0.1Ω~680Ω	681Ω~200KΩ

Radial Terminal Type - PRMT Series

立式端片型 PRMT系列

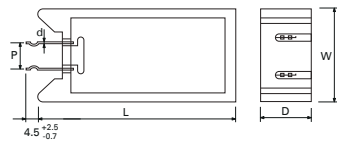

Part No. 料号	Type 类型	Dimension (尺寸)(mm)					Resistance Range 阻值范围	
		W ± 1	D ± 0.5	L ± 1	P ± 1	d ± 0.05	Wire-wound 绕线型	Power Film 切割型
PRMT15W	PRMT-15W	20	13	38	7.5	0.5	0.1Ω~560Ω	561Ω~200KΩ
PRMT20W	PRMT-20W	20	13	45	7.5	0.4		

Radial Leaded Type - PRS Series

立式导线型 PRS系列

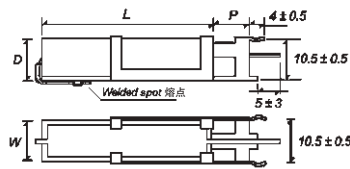

Part No. 料号	Type 类型	Dimension (尺寸)(mm)				Resistance Range 阻值范围	
		W ± 1	D ± 1	L ± 1	P ± 1	Wire-wound 绕线型	Power Film 切割型
PRS05W	PRS-5W	10	9	22	5	0.1Ω~47Ω	48Ω~150KΩ
PRS07W	PRS-7W	10	9	35	10	0.1Ω~680Ω	681Ω~200KΩ
PRS0AW	PRS-10W	10	9	49	10	0.1Ω~910Ω	911Ω~200KΩ
PRS0FW	PRS-15W	12.5	11.5	49	11	1Ω~1KΩ	1.1KΩ~200KΩ

Derating Curve (降功率曲线)

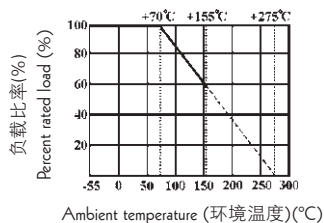

Heat Rise Chart (表面温升) (PRS)

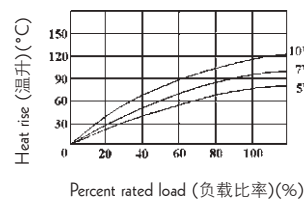

### Radial Terminal Type - PRVA Series

立式端片型-PRVA系列

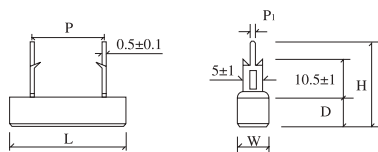

Part No. 料号	Type 类型	Dimension (尺寸)(mm)						Resistance Range 阻值范围	
		W ± 1	D ± 1	L ± 1	P ± 1	P <sub>1</sub> ± 0.2	H ± 1	Wire-wound 绕线型	Power Film 切割型
PRVA3W	PRVA-3W	10	9	22	9.5	1.3	25	0.1Ω~47Ω	48Ω~150KΩ
PRVA5W	PRVA-5W	10	9	27 / 25	15/9.5	1.3	25	0.1Ω~120Ω	121Ω~200KΩ
PRVA7W	PRVA-7W	10	9	35	22	1.3	25	0.1Ω~560Ω	561Ω~200KΩ
PRVAAW	PRVA-10W	10	9	48	35 / 32	1.3	25	1Ω~820Ω	821Ω~200KΩ
PRVAFW	PRVA-15W	12.5	11.5	48	32	1.5	24	1Ω~1KΩ	1.1KΩ~200KΩ
PRVA20	PRVA-20W	12.5	13.5	63	42	1.5	26	1Ω~1.2KΩ	1.3KΩ~200KΩ

### Radial Terminal Type - PRVB Series

立式端片型-PRVB系列

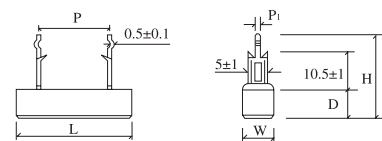

Part No. 料号	Type 类型	Dimension (尺寸)(mm)						Resistance Range 阻值范围	
		W ± 1	D ± 1	L ± 1	P ± 1	P <sub>1</sub> ± 0.2	H ± 1	Wire-wound 绕线型	Power Film 切割型
PRVB3W	PRVB-3W	10	9	22	9.5	1.3	25	0.1Ω~47Ω	48Ω~150KΩ
PRVB5W	PRVB-5W	10	9	27 / 25	15/9.5	1.3	25	0.1Ω~120Ω	121Ω~200KΩ
PRVB7W	PRVB-7W	10	9	35	22	1.3	25	0.1Ω~560Ω	561Ω~200KΩ
PRVBAW	PRVB-10W	10	9	48	35 / 32	1.3	25	1Ω~820Ω	821Ω~200KΩ
PRVBFW	PRVB-15W	12.5	11.5	48	32	1.5	27.5	1Ω~1KΩ	1.1KΩ~200KΩ
PRVB20	PRVB-20W	12.5	13.5	63	42	1.5	29.5	1Ω~1.2KΩ	1.3KΩ~200KΩ

### Heat Rise Chart of PRVA & PRVB

PRVA & PRVB表面温升

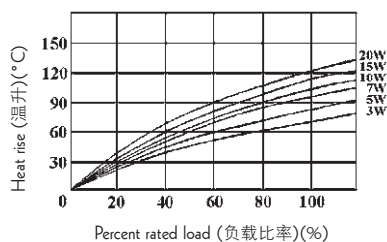

Radial Terminal Type - PRZ Series

立式端片型 PRZ 系列

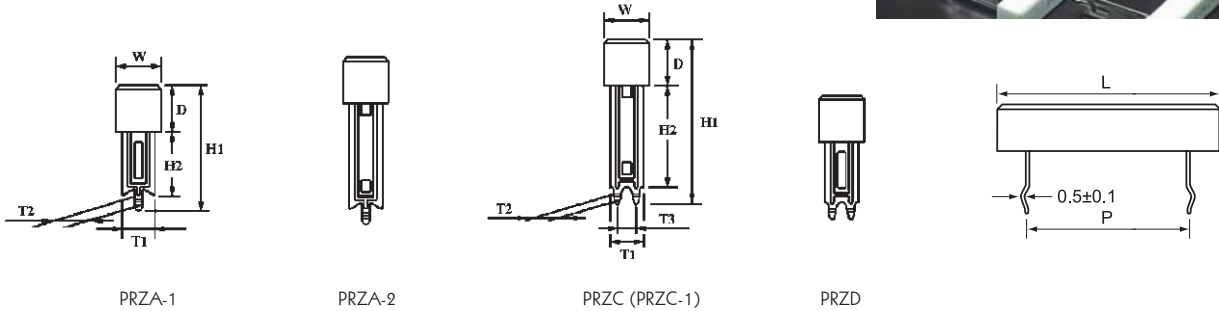

Dimension of Recommended Hole (参考尺寸孔径)(mm)

Power Rating 功率	PRZA-1, PRZA-2	PRZC, PRZD	P
3W			9.5
5W			15
7W			22
10W			35
15W			32
20W			45

Power Rating 功率	Part No. 料号	Type 类型	Dimension 尺寸 (mm)										Resistance Range 阻值范围	
			W±1	D±1	L	P±1.5	T <sub>1</sub> ±1	T <sub>2</sub> ±0.2	T <sub>3</sub> ±0.5	H <sub>1</sub> <sup>+2</sup> <sub>-1</sub>	H <sub>2</sub> <sup>+2</sup> <sub>-1</sub>	Wire-wound 绕线型	Power Film 切割型	
3W	PZ1A3W	PRZA-1						1.6	-		24	10	0.1Ω~47Ω	48Ω~150KΩ
	PZ2A3W	PRZA-2	10	9	22±1	9.5	7			39	25			
	PRZC3W	PRZC						1.5		3.5	36	22		
	PRZD3W	PRZD									24	10		
5W	PZ1A5W	PRZA-1			25/27±1	9.5/15		1.6	-		24	10	0.1Ω~120Ω	121Ω~200KΩ
	PZ2A5W	PRZA-2								39	25			
	PRZC5W	PRZC	10	9	27±1	15	7	1.5			36	22		
	PZ1C5W	PRZC-1								3.5	39	24		
7W	PRZD5W	PRZD									24	10	0.1Ω~560Ω	561Ω~200KΩ
	PZ1A7W	PRZA-1						1.6	-		24	10		
	PZ2A7W	PRZA-2									39	25		
	PRZC7W	PRZC	10	9	35±1	22	7	1.5			36	22		
10W	PZ1C7W	PRZC-1								3.5	39	24	1Ω~820Ω	821Ω~200KΩ
	PRZD7W	PRZD									24	10		
	PZ1AAW	PRZA-1						1.6	-		24	10		
	PZ2AAW	PRZA-2			48±1.5	32/35	7				39	25		
15W	PRZCAW	PRZC						1.5			36	22	1Ω~1KΩ	1.1KΩ~200KΩ
	PRZDAW	PRZD								3.5	24	10		
	PZ1AFW	PRZA-1						3	-		35	15		
20W	PZ2AFW	PRZA-2	12.5	11.5	48±1.5	32	10				47	30	2Ω~1.2KΩ	1.3KΩ~200KΩ
	PRZCFW	PRZC						2	5		47	30		
	PZ1A20	PRZA-1						3	-		35	15		
	PZ2A20	PRZA-2	12.5	13.5	63±1.5	42	10				47	30		
	PRZC20	PRZC						2	5		47	30		

### Derating Curve (降功率曲线)

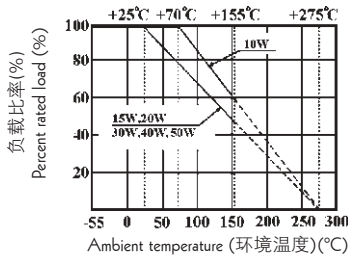

### Heat Rise Chart (表面温升)

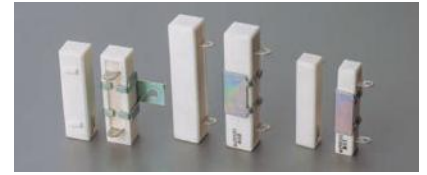
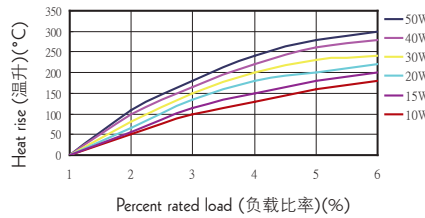

### Radial Terminal Type - PRT (With metal mounting bracket)/PRU Series

#### 立式端片型 PRT (带金属安装支架)/PRU

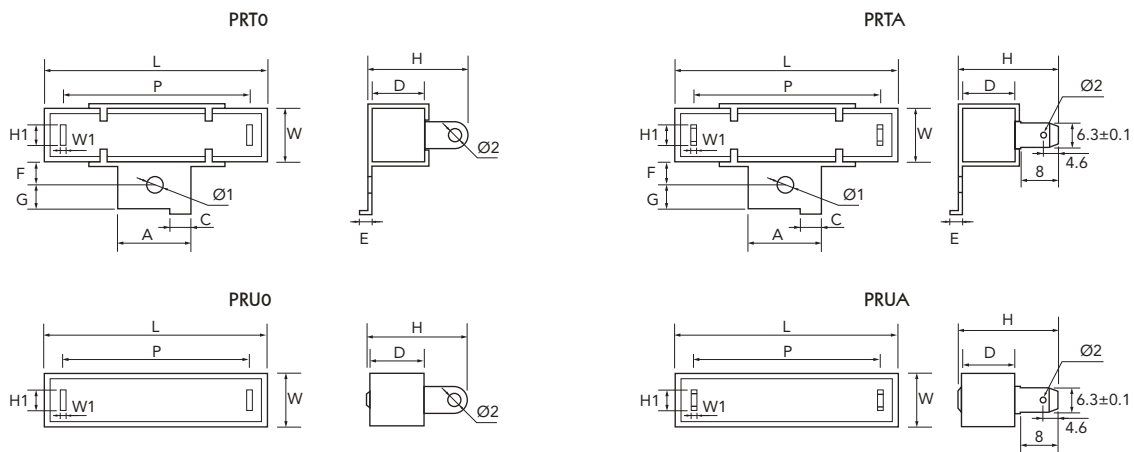

Type 类型	Dimension (尺寸)(mm)													Resistance Range 阻值范围			
	W ±1	D ±1	L	P	H ±1	A ±0.5	H1 ±0.4	C ±0.5	F ±0.5	G ±0.5	E ±1	Ø1 ±0.2	Ø2 ±0.2	W1 ±0.08	Wire-wound 绕线型	Power Film 切割型	
10W	PRT0/PRU0	10	9	48	32	18	12	5.5	3	8.7	5	3	4.1	2.5	0.5	1Ω~820Ω	821Ω~200KΩ
	PRTA/PRUA			±1.5	±1	19		8.0					1.6	0.8			
15W	PRT0/PRU0	12.5	11.5	48	32	21	12	6.2	3	8.0	6	3	4.1	2.5	0.5	1Ω~1KΩ	1.1KΩ~200KΩ
	PRTA/PRUA			±1.5	±1	23.5		7.6					1.6	0.8			
20W	PRT0/PRU0	12.5	13.5	63	44	21	12	6.2	3	10	6	3	4.1	2.5	0.5	2Ω~1.2KΩ	1.3KΩ~200KΩ
	PRTA/PRUA			±1.5	±1	25		7.6					1.6	0.8			
30W	PRT0/PRU0	19	19	75	54	32	18	7.6	3	9.5	7.5	4	4.1	3.2	0.5	3Ω~1.5KΩ	/
	PRTA/PRUA			±1.5	±1	30		7.6					6.0	1.6	0.8		
40W	PRT0/PRU0	19	19	90	70	32	18	7.6	3	9.5	7.5	4	4.1	3.2	0.5	6Ω~1.5KΩ	/
	PRTA/PRUA			±1.5	±1	30		8.0					6.0	1.6	0.8		
50W	PRT0/PRU0	19	19	90	70	32	18	7.6	3	9.5	7.5	4	4.1	3.2	0.5	6Ω~1.5KΩ	/
	PRTA/PRUA			±1.5	±1	30		8.0					6.0	1.6	0.8		

Performance Specifications (性能)

Operating temperature	工作温度范围	-55°C~+155°C
Temperature coefficient	温度系数	<20Ω: ±400PPM
		≥20Ω: ±350PPM
Short-time Overload	短时间过负荷	$\Delta R/R \leq \pm(5\% + 0.05\Omega)$ , with no evidence of mechanical damage (无可见机械损伤)
Dielectric withstanding voltage	绝缘耐压	No evidence of flashover, mechanical damage. (无击穿、飞弧及可见机械损伤)
Resistance to soldering heat	耐焊接热	$\Delta R/R \pm(1\% + 0.05\Omega)$ with no evidence of mechanical damage (无可见机械损伤)
Temperature cycling	温度循环	$\Delta R/R \leq \pm(2\% + 0.05\Omega)$ , with no evidence of mechanical damage (无可见机械损伤)
Humidity (Steady State)	恒定湿热	$\Delta R/R \leq \pm(5\% + 0.05\Omega)$ , with no evidence of mechanical damage (无可见机械损伤)
Load life in humidity	湿度寿命	Wire-wound type (绕线型): $\leq R/R = \pm 5\%$ ;
		Power Film type (切割型): <100KΩ: $\Delta R/R = \pm 5\%$ ; Power Film type (切割型): $\geq 100K\Omega$ : $\Delta R/R = \pm 10\%$ .
Load life	负载寿命	Wire-wound type (绕线型): $\Delta R/R = \pm 5\%$ ;
		Power Film type (切割型): <100KΩ: $\Delta R/R = \pm 5\%$ ; Power Film type (切割型): $\geq 100K\Omega$ : $\Delta R/R = \pm 10\%$ .

Ordering Procedure (Example: PRT 50W 5% 100Ω, B/B)

订购方式 (例如: PRT 50W 5% 100Ω, B/B)

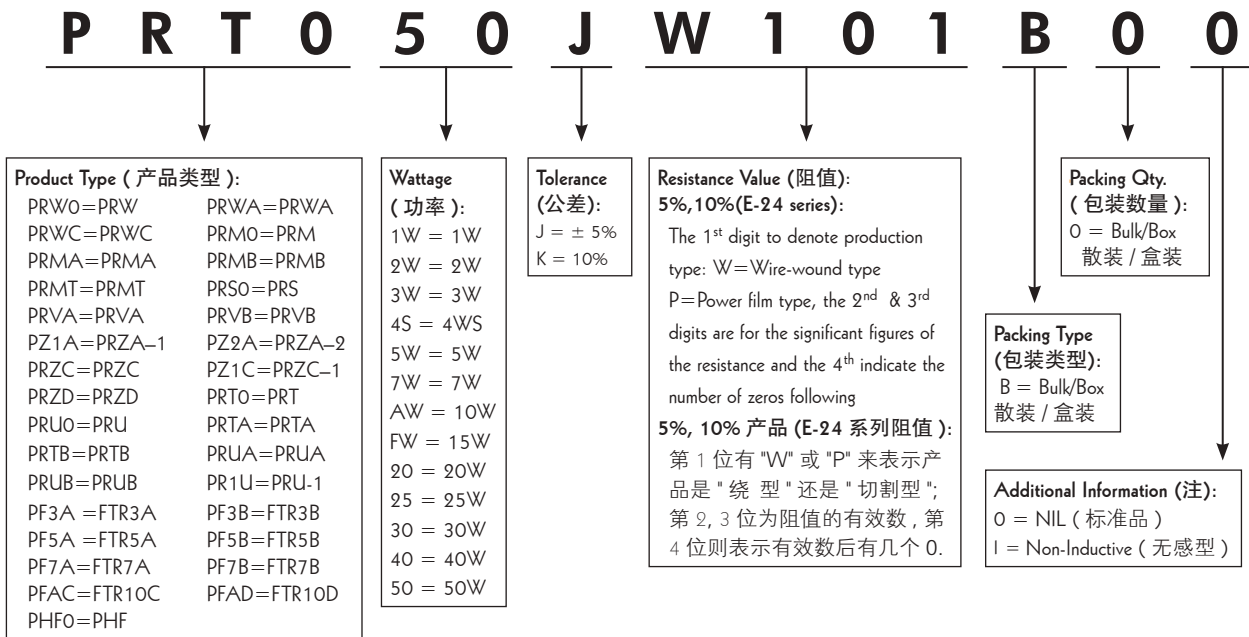

### Derating Curve (降功率曲线)

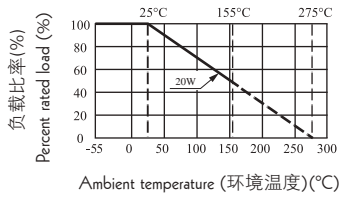

### Heat Rise Chart (表面温升)

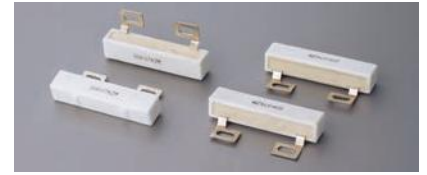
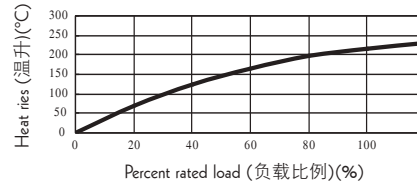

### Dimension (尺寸)(mm)

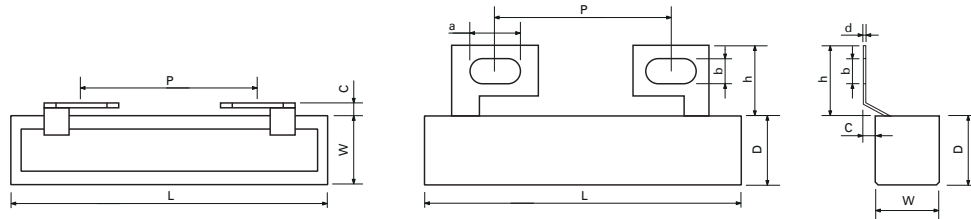

Type 类型	Dimension(尺寸)(mm)									Resistance Range 阻值范围
	W±1.0	D±1.5	L±1.5	P±1.5	a±0.8	b±0.5	c±0.5	d±0.1	h±1.0	Power Film 切割型
PRTM20W	12.5	13.5	63.0	35.0	10.0	5.0	2.5	0.8	14.0	1.3KΩ~200KΩ

### Specification (性能)

Operating temperature	工作温度范围	-55°C~+155°C
Temperature coefficient	温度系数	<20Ω: ±400PPM ≥20Ω: ±350PPM
Short-time Overload	短时间过负荷	ΔR/R ≤ ±(5%+0.05Ω), with no evidence of mechanical damage (无可见机械损伤)
Dielectric withstanding voltage	绝缘耐压	No evidence of flashover, mechanical damage. (无击穿、飞弧及可见机械损伤)
Resistance to soldering heat	耐焊接热	ΔR/R ±(1%+0.05Ω) with no evidence of mechanical damage (无可见机械损伤)
Temperature cycling	温度循环	ΔR/R ≤ ±(2%+0.05Ω), with no evidence of mechanical damage (无可见机械损伤)
Humidity (Steady State)	恒定湿热	ΔR/R ≤ ±(5%+0.05Ω), with no evidence of mechanical damage (无可见机械损伤)
Load life in humidity	湿度寿命	Wire-wound type (绕线型): ≤R/R = ±5%;
		Power Film type (切割型): <100KΩ: ΔR/R = ±5%; Power Film type (切割型): ≥100KΩ: ΔR/R = ±10%.
Load life	负载寿命	Wire-wound type (绕线型): ΔR/R = ±5%;
		Power Film type (切割型): <100KΩ: ΔR/R = ±5%; Power Film type (切割型): ≥100KΩ: ΔR/R = ±10%.

### Ordering Procedure (Example: PRTM 20W 5% 1.3KΩ, B/B)

订购方式 (例如: PRTM 20W 5% 1.3KΩ, B/B)

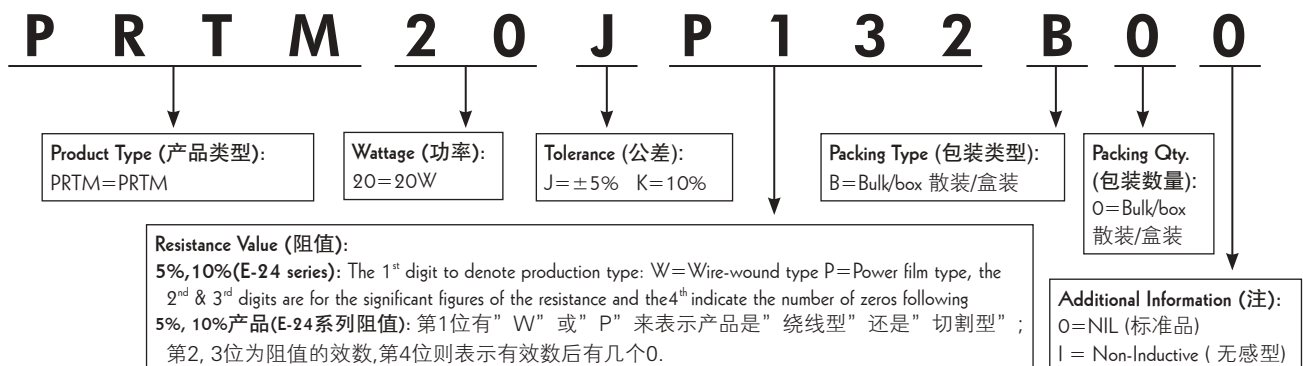

**Leaded Type Cement Thermal Fusing Resistors - FTR Series**  
立式导线型保险丝电阻 FTR系列

**Derating Curve**  
降功率曲线

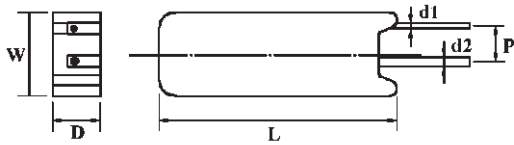

\*FTR3A, FTR3B, FTR5A, FTR5B, FTR10C: leads centered (居中)

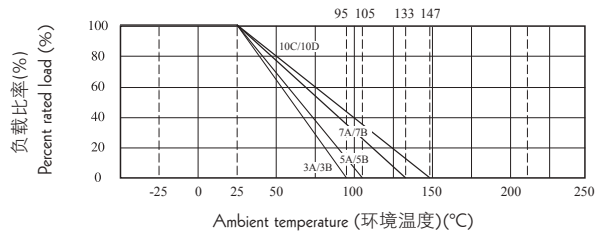

Part No. 料号	Type 类型	Power Rating 功率	Dimension (尺寸)(mm)						Cut-Off Temperature 熔断温度	Rated Current 额定电流	Rated Voltage 额定电压	Tolerance 公差	Resistance Range 阻值范围	
			D±1	L±1	d <sub>1</sub> <sup>+0.02</sup> <sub>-0.05</sub>	d <sub>2</sub> ±0.05	P±1	W±1					Wire-wound 绕线型	Power Film 切割型
PF3A00	FTR3A	1.5W	8.5	25	0.5	0.70	5	12.5	130±4°C				1Ω-27Ω	28Ω~120KΩ
PF3B00	FTR3B	2W							145±4°C					
PF5A00	FTR5A	1.6W	9	25	0.5	0.75	5	12.5	130±4°C	2A	250V	±5% & ±10%	1Ω-39Ω	40Ω-120KΩ
PF5B00	FTR5B	2.1W							145±4°C					
PF7A00	FTR7A	2.2W	9	38	0.5	0.75	5	12.5	130±4°C				1Ω-47Ω	48Ω-150KΩ
PF7B00	FTR7B	2.7W							145±4°C					
PFAC00	FTR10C	3.5W	12	35	1	0.75	7.5	16.5	188+3/-1°C	10A	250V		1Ω-47Ω	48Ω-150KΩ
PFADAW	FTR-10D	10W	12	35	1	1.00	7.5	16.5	235±3°C	10A	250V	±10%	1Ω-120Ω	121Ω-200KΩ

**Leaded Type Cement Thermal Fusing Resistors - PHF Series**  
立式弹片型保险丝电阻PHF系列

**Derating Curve**  
降功率曲线

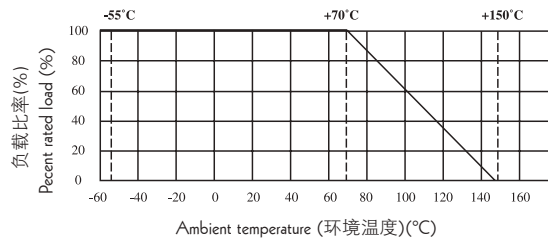
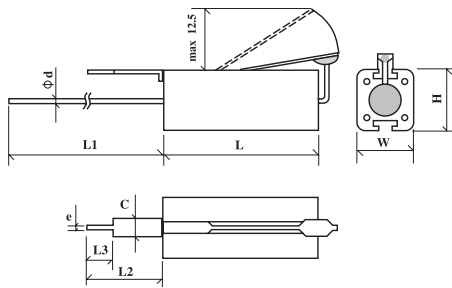

Part No. 料号	Type 类型	Dimension (尺寸)(mm)									Resistance Range 阻值范围 (Wire-wound) (绕线型)	Cut-Off Temperature 熔断温度
		L±1.0	W±1.0	H±1.0	L1±3.0	L2±1.5	L3±0.5	C±0.1	e±0.1	Ød±0.05		
PHF02W	PHF-2W	25	9	10	38	13.0	4.5	3.0	0.9	0.75	1Ω~470Ω	150±20°C



### PHF1 & PHF2 Series

#### 水泥型电阻器PHF1及PHF2系列

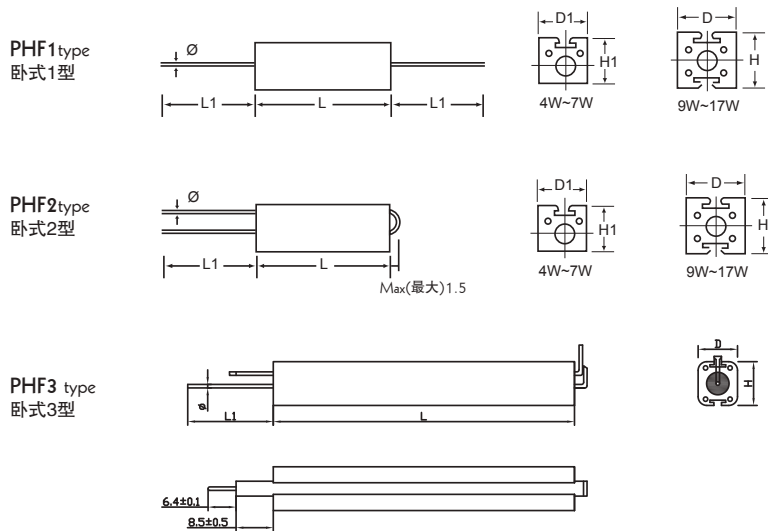

#### Dimension (外形尺寸)(mm)

Part No. 料号	Wattage 功率	H±1.5	H1±0.5	D±0.5	D1±0.5	L	L1±3	Ø±0.05	Resistance Range 阻值范围	Remark 备注
PHF1 4W	4W	/	8.5	/	7.5	20±1	30	0.75	1Ω~1KΩ	
PHF2 4W	4W	/	8.5	/	7.5	20±1	30	0.75	1Ω~1KΩ	
PHF1 5W	5W	/	8.5	/	7.5	25±1	30	0.75	1Ω~2.2KΩ	
PHF2 5W	5W	/	8.5	/	7.5	25±1	30	0.75	1Ω~2.2KΩ	the leads could be specially designed according to customer's requirement
PHF1 7W	7W	/	9.5	/	7.5	38±1	30	0.75	1Ω~6.2KΩ	
PHF2 7W	7W	/	9.5	/	7.5	38±1	30	0.75	1Ω~6.2KΩ	
PHF1 9W	9W	10	/	9	/	38±1	30	0.75	1Ω~6.2KΩ	
PHF2 9W	9W	10	/	9	/	38±1	30	0.75	1Ω~6.2KΩ	
PHF1 11W	11W	10	/	9	/	50±1	30	0.75	1Ω~6.2KΩ	引出线可根据客户的要求特别定做
PHF2 11W	11W	10	/	9	/	50±1	30	0.75	1Ω~6.2KΩ	
PHF3 11W	11W	10	/	9	/	50±1	10	0.75	1Ω~6.2KΩ	
PHF1 17W	17W	10	/	9	/	75±2	30	0.75	1Ω~10KΩ	
PHF2 17W	17W	10	/	9	/	75±2	30	0.75	1Ω~10KΩ	
PHF3 17W	17W	10	/	9	/	75±2	10	0.75	1Ω~10KΩ	

#### Performance Specifications (性能)

Rated Power	额定功率	4W~17W
Tolerance	公差	J(±5%) K(±10%)
Temperature coefficient	温度系数	±350ppm/°C
Short-time overload	短时间过负荷	ΔR/R ≤ ±(3%+0.05Ω), with no evidence of mechanical damage (无可见机械损伤)
Dielectric withstanding voltage	绝缘耐压	No evidence of flashover, mechanical damage.(2000V) [无击穿、飞弧及可见机械损伤.(2000V)]
Terminal strength	端子强度	No evidence of mechanical damage (无可见机械损伤)
Soldering heat	耐焊接热	ΔR/R < ±(1%+0.05Ω),with no evidence of mechanical damage (无可见机械损伤)
Load life	负载寿命	ΔR/R ≤ ±5%,with no evidence of mechanical damage (无可见机械损伤)

Feature (特性)

- Alloy material & low-inductive 合金材料，低感量
- Working stably under high current 大电流下可稳定工作
- Excellent temperature & moisture resistance 良好的耐温性和耐湿性

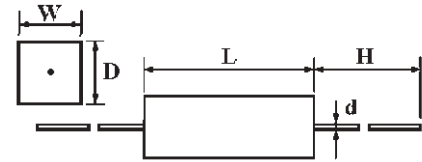

Dimension (尺寸) (mm)

Part No. 料号	Type 类型	W±1	D±1	L±1	H±5	Ød±0.05	Rated Current 额定电流	Resistance Range 阻值范围
PRWUAW	PRWU 10W	10.0	9.0	49.0	35.0	0.80	30A	0.01Ω~0.02Ω
PRWU15	PRWU 15W	12.5	11.5	49.0	35.0	1.00	40A	0.01Ω~0.039Ω
PRWU20	PRWU 20W	14.5	13.5	60.0	35.0	1.00	40A	0.01Ω~0.039Ω
PRWU25	PRWU 25W	14.5	13.5	64.0	35.0	1.00	40A	0.01Ω~0.051Ω

Performance Specifications (性能)

Temperature coefficient 温度系数	±300PPM/°C
Load life in humidity 湿度寿命	ΔR/R ≤ ±(5.0%+0.05Ω), with no evidence of mechanical damage (无可见机械损伤)
Solderability 可焊性	Min. 95% coverage (最少95%覆盖率)
Temperature cycling 温度循环	ΔR/R ≤ ±(2.0%+0.05Ω), with no evidence of mechanical damage (无可见机械损伤)
Load life 负载寿命	ΔR/R ≤ ±(5.0%+0.05Ω), with no evidence of mechanical damage (无可见机械损伤)

### Feature (特性)

- Low inductance 低电感量
- Safety flameproof construction 耐高温
- Thin & lightweight body save the PCB space considerably 体积小轻薄, 节省PCB空间
- Automatically insertable 可自动插件

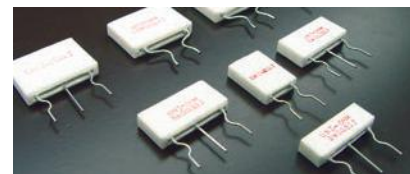

### PFAS (Single Circuit) Dimension (mm)

#### PFAS (单电路) 尺寸(mm)

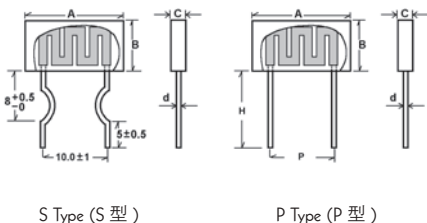

Part No. 料号	Type 类型	Power Rating 功率 70°C	Dimension (尺寸)(mm)					Resistance Range 阻值范围 (5% & 10%)
			A±0.5	B±0.5	C±0.5	d±0.05	P±1.0	
PFAS2W	PFAS 2W	2W	13.0	8.5	5.0	0.75		0.01Ω~1Ω
PFAS3W	PFAS 3W	3W	13.0	13.5	5.0	0.75	10	0.01Ω~1Ω
PFAS5W	PFAS 5W	5W	14.0	18.0	5.0	0.75	4 & 10	0.01Ω~1Ω
PFASAW	PFAS 10W	10W	26.0	18.0	5.0	1.00	20	0.01Ω~3.3Ω

### PFAT (Twin Circuit) Dimension (mm)

#### PFAT (双电路) 尺寸(mm)

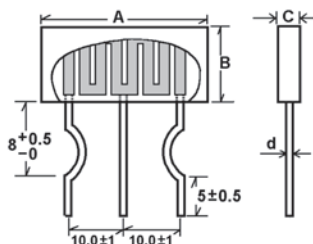

Part No. 料号	Type 类型	Power Rating 功率 70°C	Dimension (尺寸)(mm)				Resistance Range 阻值范围 (5% & 10%)
			A±0.5	B±0.5	C±0.5	d±0.05	
PFAT2W	PFAT 2W+2W	2W	26.0	9.0	5.0	0.75	0.05Ω~1Ω
PFAT3W	PFAT 3W+3W	3W	26.0	13.0	5.0	0.75	0.05Ω~1Ω
PFAT5W	PFAT 5W+5W	5W	26.0	18.0	5.0	0.75	0.05Ω~1Ω
PFAT7W	PFAT 7W+7W	7W	26.0	20.0	5.0	1.00	0.1Ω~1Ω

### Heat Rise Chart (PFAS)

#### 表面温升(PFAS)

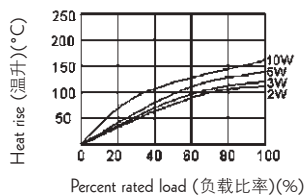

### Heat Rise Chart (PFAT)

#### 表面温升(PFAT)

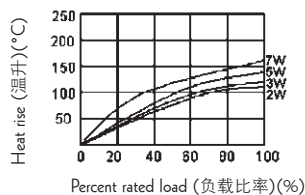

### Derating Curve

#### 降功率曲线

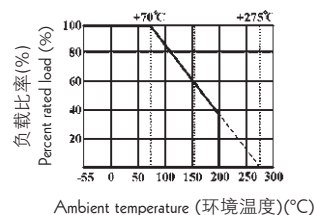

Performance Specifications (性能)

Temperature coefficient	温度系数	0.01Ω~0.1Ω Please contact uniohm ( 请联系 UNIOHM) >0.1Ω: $\leq \pm 350\text{PPM}/^\circ\text{C}$
Short-time overload	短时间过负荷	$\Delta R/R \leq \pm 2\%$ , with no evidence of mechanical damage ( 无可见机械损伤)
Dielectric withstanding voltage	绝缘耐压	2,000V
Operating temperature	工作温度范围	-55°C ~ +200°C
Terminal strength	端子强度	No evidence of mechanical damage ( 无可见机械损伤)
Soldering heat	耐焊接热	$\Delta R/R \leq \pm 1\%$ , with no evidence of mechanical damage ( 无可见机械损伤)
Solderability	可焊性	Min. 95% coverage ( 最少 95% 覆盖率)
Resistance to solvent	耐溶剂	No deterioration of protective coating and markings ( 包封层, 色码完整)
Temperature cycling	温度循环	$\Delta R/R \leq \pm 5\%$ , with no evidence of mechanical damage ( 无可见机械损伤)
Humidity (Steady State)	恒定湿热	$\Delta R/R \leq \pm 5\%$ , with no evidence of mechanical damage ( 无可见机械损伤)
Load life in humidity	湿度寿命	$\Delta R/R \leq \pm 5\%$ , with no evidence of mechanical damage ( 无可见机械损伤)
Load life	负载寿命	$\Delta R/R \leq \pm 5\%$ , with no evidence of mechanical damage ( 无可见机械损伤)

Ordering Procedure (Example: PFAS 5W 5% 0.68Ω, B/B)

订购方式(例如: PFAS 5W 5% 0.68Ω, B/B)

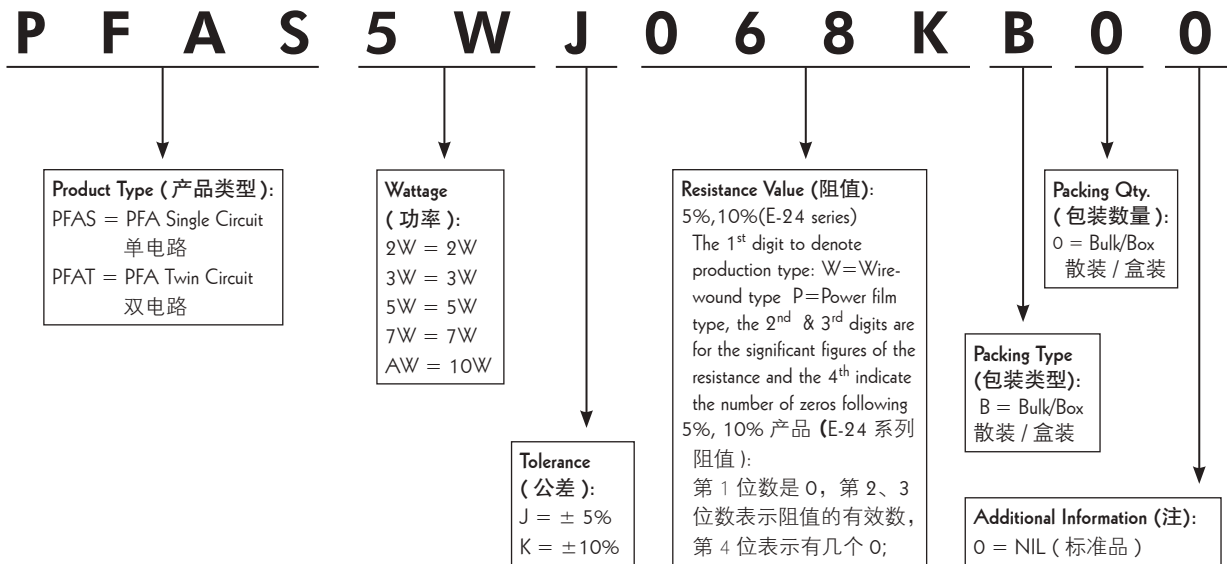

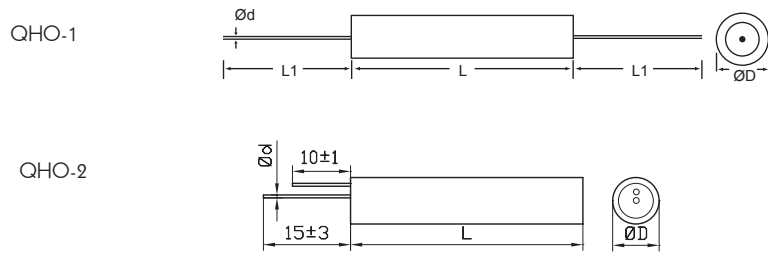

### Dimension (外形尺寸) (mm)

Type 料号	L±1	L1±3	ØD±1	Ød±0.05	Resistance Range 阻值范围	Remark 备注
QHO4W	43	30	8	0.8	1Ω~6.2KΩ	the leads can be specially designed according to customer's requirement
QHO5W	45	30	8	0.8		
QHO7W	50	30	9	0.8		
QHO9W	60	30	9	0.8	1Ω~10KΩ	引出线可根据客户的要求特别定做
QHO11W	65	30	9	0.8		
QHO17W	75	30	9	0.8		

The resistor of same Wattage QHO-1 & QHO-2 are same, only the lead type is different.

同功率的QHO-1型和QHO-2型仅引出线方式不同,电阻体本身相同。

### Performance Specifications (性能)

Tolerance	阻值精度	J(±5%) K(±10%)
Temperature coefficient	温度系数	<20Ω:±400ppm/°C, ≥20Ω:±350ppm/°C
Short-time overload	短时间过负荷	R/R ≤ ±(5%+0.05Ω), with no evidence of mechanical damage (无可见机械损伤)
Terminal strength	端子强度	No evidence of mechanical damage (无可见机械损伤)
Soldering heat	耐焊接热	R/R ≤ ±(1%+0.05Ω), with no evidence of mechanical damage (无可见机械损伤)
Solderability	可焊性	Min. 95% coverage (最少95%覆盖率)
Temperature cycling	温度循环	R/R ≤ ±(2%+0.05Ω), with no evidence of mechanical damage (无可见机械损伤)
Humidity (Steady State)	恒定湿热	R/R ≤ ±(5%+0.05Ω), with no evidence of mechanical damage (无可见机械损伤)
Load life	负载寿命	R/R ≤ ±5%, with no evidence of mechanical damage (无可见机械损伤)

Plastic Bag Packing [A 型包装 ( 塑料袋式包装 ) ]

Inner Box of Plastic Bag Packing ( 内盒塑料袋式包装 )

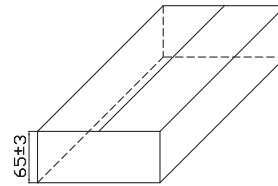
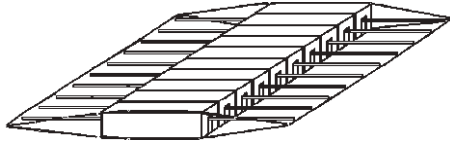

Part NO. 料号	Type 类型	Qty. Per Bag/Box 袋 / 盒 数量	Qty. per Carton 数量 ( 箱 )	Carbon Dimention 外箱尺寸 (±5mm)	GW 毛重 (±2kg)
<b>PRW Series (PRW 系列)</b>					
PRW02W	PRW 2W	10 / 600	3,600	547 x 215 x 245	12.5
PRW03W	PRW 3W	10 / 500	3,000		14
PRW05W	PRW 5W	10 / 400	2,400		14.5
PRW07W	PRW 7W	10 / 300	1,800		17
PRW0AW	PRW 10W	10 / 250	1,500		18
PRW0FW	PRW 15W	10 / 140	840		16.5
PRW020	PRW 20W	10 / 120	720		21
PRWA2W	PRWA 2W	10 / 600	3,600		12.5
PRWA5W	PRWA 5W	10 / 400	2,400		14.5
PRWA7W	PRWA 7W	10 / 300	1 800		17
PRWAAW	PRWA 10W	10 / 250	1 500		18
PRWC3W	PRWC 3W	10 / 600	3,600		12.5
PRWC5W	PRWC 5W	10 / 600	3,600		14
PRWC7W	PRWC 7W	10 / 400	2,400		16
<b>PRS Series (PRS 系列)</b>					
PRS05W	PRS 5W	10 / 400	2,400	547 x 215 x 245	18
PRS07W	PRS 7W	10 / 300	1,800		17
PRS0AW	PRS 10W	10 / 250	1,500		22
<b>PRT Series (PRT 系列)</b>					
PRT0AW	PRT 10W	10 / 200	1,200	547 x 215 x 245	20
PRT0FW	PRT 15W	10 / 120	720		18
PRT020	PRT 20W	10 / 90	540		17.5
PRT030	PRT 30W	5 / 45	270		22
PRT040	PRT 40W	5 / 25	150		14.2
PRT050	PRT 50W	5 / 25	150		14.2
<b>PRU Series (PRU 系列)</b>					
PRU0AW	PRU 10W	10 / 200	1,200	547 x 215 x 245	14
PRU0FW	PRU 15W	10 / 160	960		18.5
PRU020	PRU 20W	10 / 90	540		15
PRU030	PRU 30W	5 / 60	360		24
PRU040	PRU 40W	5 / 50	300		24.5
PRU050	PRU 50W	5 / 50	300		24.5

### Poly-Foam Packing [B 型包装 (泡沫盒)]

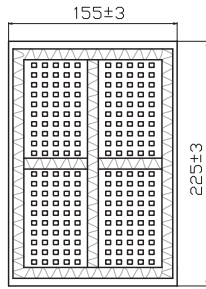

### Inner Box of Poly-Foam Packing (泡沫内盒式包装)

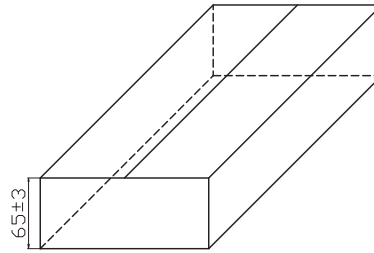

Part NO. 料号	Type 类型	Qty. per Box 数量 (盒)	Qty. per Carton 数量 (箱)	Carton Dimension 外箱尺寸 (± 5mm)	GW 毛重 (± 2kg)
<b>PRV Series (PRV 系列)</b>					
PRVA3W	PRVA 3W	200	2,000	440 x 255 x 195	16.5
PRVA5W (6W)	PRVA 5W (6W)	200	2,000	510 x 315 x 230	17.5
PRVA7W	PRVA 7W	100	1,000	373 x 219 x 240	13.5
PRVAAW	PRVA 10W	100	1,200	445 x 275 x 225	20
PRVAFW	PRVA 15W	100	1,000	509 x 281 x 191	20
PRVA20	PRVA 20W	75	684	445 x 275 x 45	18
PRVB3W	PRVB 3W	200	2,000	510 x 315 x 230	16.3
PRVB5W (6W)	PRVB 5W (6W)	200	2,000	510 x 315 x 230	17.5
PRVB7W	PRVB 7W	100	1,200	373 x 219 x 240	16.5
PRVBAW	PRVB 10W	100	1,200	445 x 275 x 45	20
PRVBFW	PRVB 15W	100 / 1,000	100 / 1,000	611 x 312 x 307	20
PRVB20	PRVB 20W	100 / 700	100 / 700	611 x 312 x 307	18.6
<b>PRZ Series (PRZ 系列)</b>					
PZ1A5W	PRZA-1 5W	200	2,000	510 x 315 x 230	17.5
PZ2A5W	PRZA-2 5W	200	1,600	510 x 315 x 230	14
PRZC5W	PRZC 5W	200	1,600	510 x 315 x 230	14
PZ1C5W	PRZC-1 5W	200	2,000	510 x 315 x 230	17.5
PRZD5W	PRZD 5W	200	2,000	510 x 315 x 230	17.5
PZ1A7W	PRZA-1 7W	100	1,000	373 x 219 x 240	16.5
PZ2A7W	PRZA-2 7W	100	1,000	470 x 305 x 280	6
PRZC7W	PRZC 7W				
PZ1C7W	PRZC-1 7W	100	1,000	373 x 219 x 240	16.5
PRZD7W	PRZD 7W				
PZ1AAW	PRZA-1 10W	100	1,200	445 x 275 x 415	20
PZ2AAW	PRZA-2 10W	100	1,000	470 x 305 x 280	16.3
PRZCAW	PRZC 10W	100	1,000	450 x 315 x 268	16.3
PRZDAW	PRZD 10W	100	1,200	445 x 275 x 415	20
PZ1AFW	PRZA-1 15W	100	800	509 x 191 x 281	16
PZ2AFW	PRZA-2 15W	100	800	509 x 239 x 281	16
PRZCFW	PRZC 15W	12.5 / 100	800	535 x 281 x 289	16
PZ1A20	PRZA-1 20W	18.6 / 57	684	445 x 275 x 415	20
PZ2A20	PRZA-2 20W	64 / 320	640	540 x 325 x 275	17
PRZC20	PRZC 20W	100	600	533 x 351 x 336	16

Plastic Case Packing [C 型包装 (塑料格板)]

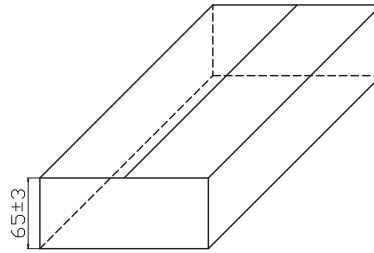
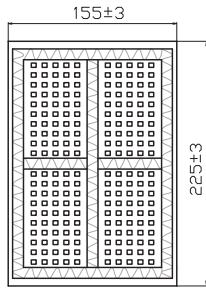

Part No. 料号	Type 类型	Case Type 包装类型	Box Dimension 内盒尺寸 (±5mm)			Qty. per Box 数量 (内盒)	Qty. per Carton 数量 (箱)	Carton Dimension 外箱尺寸 (± 5mm)	GW 毛重 (±2kg)
			A	B	C				
<b>PRM Series (PRM 系列)</b>									
PRM02W	PRM 2W	67-A	185	35	130	200	3,000	465 x 235 x 245	13
PRM03W	PRM 3W	67-A	185	35	130	200	3,000	465 x 235 x 245	20.5
PRM05W	PRM 5W	41-A	225	40	155	200	2,000	330 x 245 x 235	14
PRMA5W	PRMA 5W	41-A	225	40	155	200	2,000	330 x 245 x 235	14
PRMB5W	PRMB 5W								
PRM07W	PRM 7W	83-A	218	55	165	200	1,200	535 x 235 x 135	13.5
PRMB7W	PRMB 7W								
PRM0AW	PRM 10W	45-A	225	65	155	200	1,200	414 x 307 x 196	17.5
PRMAAW	PRMA 10W	73-A	165	49	137	100	2,000	290 x 232 x 238	32
PRMBAW	PRMB 10W	72-A	300	35	24	200	1,200	460 x 230 x 155	17.2



### Feature (特性)

- With Aluminum Shell for a good heat dissipation, suitable for board mount  
铝外壳散热性能好, 适用于散热板安装
- Thin & lightweight body with big power rating 本体小而轻, 功率大
- Low inductance 低感量
- Application: Power Supply, Adapter, Machine 应用: 设备电源类

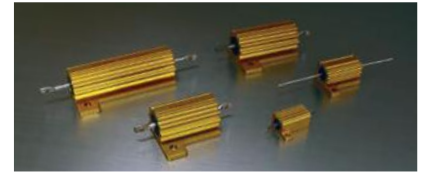

### Derating Curve (降功率曲线)

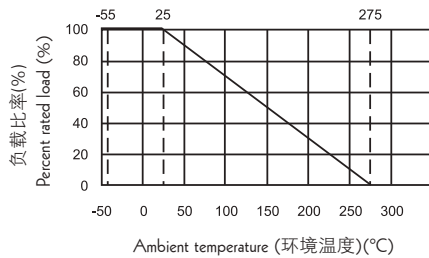

### Dimension (尺寸) (mm)

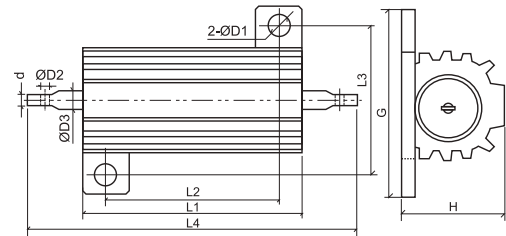

Part No. 料号	Type 类型	L1±0.5	L2±0.5	L3±0.5	L4±1.0	H±0.5	G±0.5	ØD1±0.5	ØD2±0.2	ØD3±0.05	d±0.2	Tolerance 公差	Max. Working Voltage 最大工作电压	Max. Overload Voltage 最大过负荷电压	Resistance Range 阻值范围
PDM05W	PDM 5W	15.5	11.0	12.0	32.5	8.0	16	2	1.3	1.0	0.3		200	400	0.01Ω~1.8KΩ
PDM0AW	PDM 10W	20.5	15.2	17.2	40.5	12.2	22.3	2.5	2.0	2.0	0.8		300	600	0.05Ω~5KΩ
PDM025	PDM 25W	27.5	18.2	20.2	45.5	16.3	30.3	3.0	2.0	2.0	0.8	±5%	550	1100	0.05Ω~12KΩ
PDM035	PDM 35W	34.5	24.2	20.2	56.5	16.3	30.3	3.0	2.0	2.0	0.8		950	1900	0.05Ω~15KΩ
PDM050	PDM 50W	50.5	40.2	20.2	78.5	16.3	30.3	3.0	2.0	2.0	0.8		1250	2500	0.05Ω~35KΩ

### Performance Specifications (性能)

Temperature coefficient	温度系数	<20Ω: ±400PPM/°C; ≥20Ω: ±350PPM/°C
Short-time overload	短时间过负荷	ΔR/R ≤ ±(5%+0.05Ω), with no evidence of mechanical damage (无可见机械损伤)
Dielectric withstanding voltage	绝缘耐压	No evidence of flashover, mechanical damage, arcing or insulation breakdown 无击穿、飞弧及可见机械损伤
Terminal strength	端子强度	No evidence of mechanical damage (无可见机械损伤)
Soldering heat	耐焊接热	ΔR/R ≤ ±(1%+0.05Ω), with no evidence of mechanical damage (无可见机械损伤)
Solderability	可焊性	Min. 95% coverage (最少 95% 覆盖率)
Temperature cycling	温度循环	ΔR/R ≤ ±(2%+0.05Ω), with no evidence of mechanical damage (无可见机械损伤)
Humidity (Steady State)	恒定湿度	ΔR/R ≤ ±(5%+0.05Ω), with no evidence of mechanical damage (无可见机械损伤)
Load life	负载寿命	ΔR/R ≤ ±(5%+0.05Ω)

### Ordering Procedure (Example: PDM 25W 5% 10Ω B/B)

订购方式(例如: PDM 25W 5% 10Ω B/B)

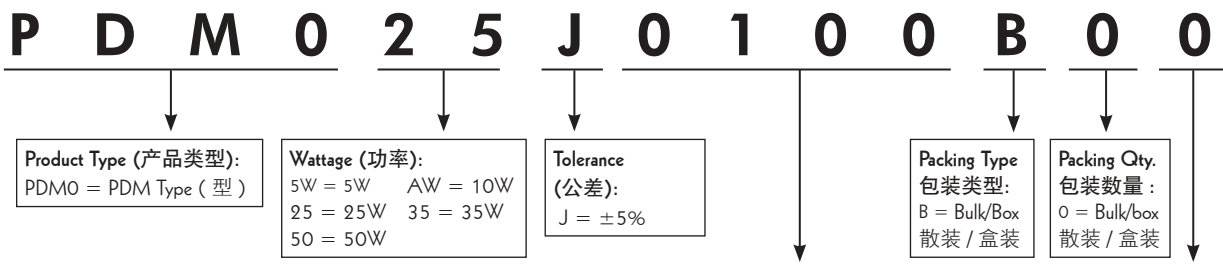

**Resistance Value (阻值):**  
**5% (E-24 series):** the 1<sup>st</sup> digit is "0", the 2<sup>nd</sup> & 3<sup>rd</sup> digits are for the significant figures of the resistance and the 4<sup>th</sup> indicate the numbers of zeros following  
 5% 产品 (E-24 系列阻值):  
 第 1 位数是 0, 第 2、3 位数表示阻值的有效数, 第 4 位表示有几个 0;

**Additional Information (注):**  
 0 = NIL (标准品)

Derating Curve (降功率曲线)

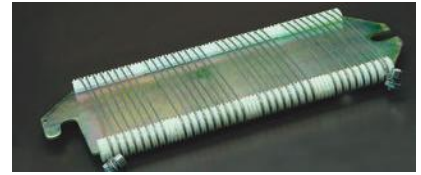
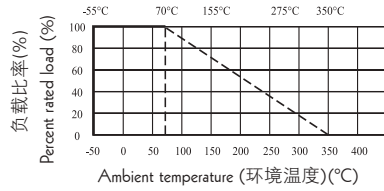

Dimension (尺寸) (mm)

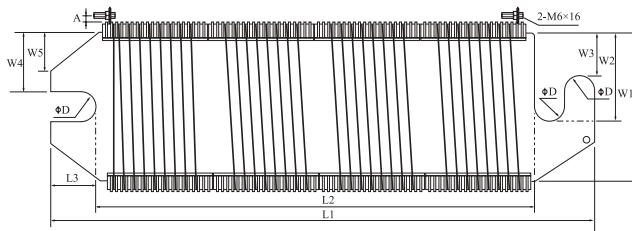

Part No. 料号	Type 类型	L1±1.5	L2±1.0	L3±2.0	W1±1.0	W2±0.5	W3±0.3	W4±0.5	W5±0.3	D±0.2	A±1.0
BTR0.....350	BTR 350W	305	255	21	108	61	40	47	35	14	12

Performance Specifications (性能)

Power rating at 70°C	功率 (70°C)	350W
Resistance range	阻值范围	1.0Ω ~ 10.0Ω
Tolerance	公差	± 20%
Operating temperature	工作温度范围	-55°C ~ +350°C
Temperature coefficient	温度系数	±350 PPM/°C
Short-time overload	短时间过负荷	$\Delta R/R \leq \pm(2\% + 0.05\Omega)$ , with no evidence of mechanical damage (无可见机械损伤)
Temperature cycling	温度循环	$\Delta R/R \leq \pm(5\% + 0.05\Omega)$ , with no evidence of mechanical damage (无可见机械损伤)
Humidity (Steady State)	恒定湿热	$\Delta R/R \leq \pm(5\% + 0.05\Omega)$ , with no evidence of mechanical damage (无可见机械损伤)
Load life in humidity	湿度寿命	$\Delta R/R \leq \pm(5\% + 0.05\Omega)$ , with no evidence of mechanical damage (无可见机械损伤)
Load life	负载寿命	$\Delta R/R \leq \pm(5\% + 0.05\Omega)$ , with no evidence of mechanical damage (无可见机械损伤)

### Feature (特性)

- All materials are inorganic and inherently non-burning  
所有的材料均为无机或非燃性的固体材料
- The vitreous coating and marking are resistant to all accepted industrial cleaning fluids  
涂层抗工业清洗液
- Low temperature coefficient 低温度系数
- Could endure high voltage's impulse in a short time 短时间可承受高电压脉冲
- Could use in single or in-piles 可单个或成堆使用
- Application: Mechanical device, Industry equipment. 应用：机械设备，工业机器



### Dimension (尺寸) (mm)

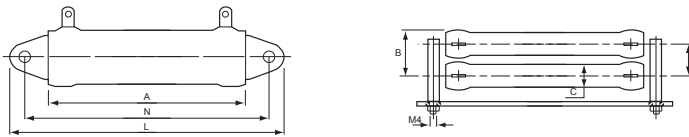

Type 类型	A ± 2	B ± 1	C ± 0.5	D ± 1	L ± 1.5	N ± 2
KNHB21W	32	19	12	14	68	51
KNHB31W	51	19	12	14	87	70
KNHB53W	90	19	12	14	126	109
KNHB68W	120	19	12	14	156	140
KNHB91W	153	19	12	14	189	173

### Performance Specifications (性能)

Resistance range	阻值范围	1Ω~1KΩ
Tolerance	公差	J(±5%) K(±10%)
Short-time overload	短时间过负荷	R/R ≤ ±(2%+0.05Ω), with no evidence of mechanical damage (无可见机械损伤)
Max. working voltage	最大工作电压	21W:350V 31W:700V 53W:1000V 68W & 91W:1500V
Temperature coefficient	温度系数	±200ppm / °C
Insulation resistance	绝缘阻值	100MΩ
Terminal strength	端子强度	No evidence of mechanical damage (无可见机械损伤)
Humidity (Steady State)	恒定湿热	ΔR/R ≤ ±(2%+0.05Ω), with no evidence of mechanical damage (无可见机械损伤)
Load life	负载寿命	ΔR/R ≤ ±(5%+0.05Ω), with no evidence of mechanical damage (无可见机械损伤)

Feature (特性)

- All materials are inorganic and inherently non-burning  
所有的材料均为无机或非燃性的固体材料
- Industrial grade Wire-wound resistors 工业线绕电阻
- Super heat dissipation & High stability 散热性高，稳定性好
- Special design of Multi-lead wire easy to assembled on PCB  
特殊设计的多导线易于在PCB上安装
- Application: charge resistor or step-down resistor in Electric device  
应用：电气设备的充电电阻或降压电阻



Dimension (尺寸) (mm)

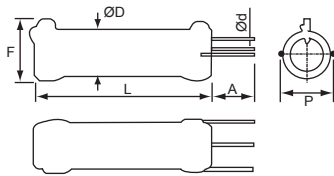

Derating Curve (降功率曲线)

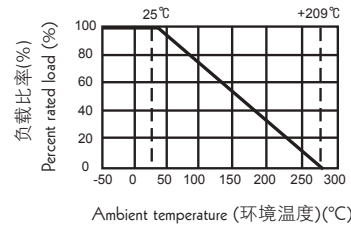

Type 类型	L±1	A±1	F±1	P±1	ØD±1	Ød±0.05	Remark 备注
KNHW10W	45	10	15	12	11.5	1.0	the leads could be specially designed according to customer's requirement 引出线可根据客户的要求特别定做
KNHW18W	40	12	18	15	14.5	1.0	
KNHW25W	50	12	18	15	14.5	1.0	
KNHW40W	65	12	20	17	16.5	1.6	

Performance Specifications (性能)

Temperature coefficient	温度系数	±100ppm/°C
Short-time overload	短时间过负荷	$\Delta R/R \leq \pm(2\%+0.05\Omega)$ , with no evidence of mechanical damage (无可见机械损伤)
Terminal strength	端子强度	No evidence of mechanical damage (无可见机械损伤)
Soldering heat	耐焊接热	$\Delta R/R \leq \pm(1\%+0.05\Omega)$ , with no evidence of mechanical damage (无可见机械损伤)
Solderability	可焊性	Min. 95% Coverage (最少 95% 覆盖率)
Load life in humidity	湿度寿命	$\Delta R/R \leq \pm 5\%$ , with no evidence of mechanical damage (无可见机械损伤)
Load life	负载寿命	$\Delta R/R \leq \pm 5\%$ , with no evidence of mechanical damage (无可见机械损伤)

### Feature (特性)

- Anti-vibration, high stability  
优异的抗震性和稳定性
- Easy to assembled on PCB  
易于在PCB上安装
- Application: Electric device  
应用于电气设备

### Derating Curve (降功率曲线)

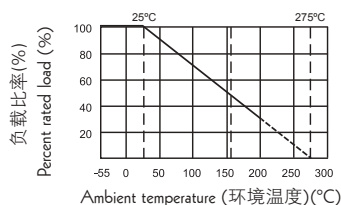

### Dimension (尺寸) (mm)

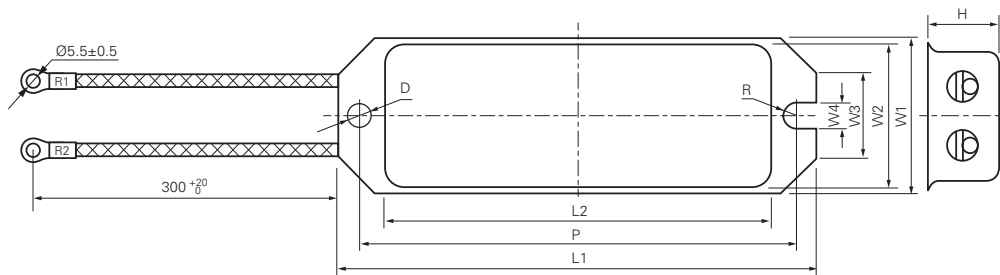

Part No. 料号	Type 类型	Dimension(尺寸) (mm)										Resistance Range 阻值范围
		L1±1	L2±1	L3	P±1	W1±1	W2±1	W3±0.5	W4±0.2	D±0.2	H±1	
HAWR60	HAWR 60W	100	75.5	300	90	30	28	16.5	4.5	4.5	16.5	1Ω~2KΩ
HAWR80	HAWR 80W	130.5	104.5	300	117.5	43	38.5	22	6.0	6.0	21	1Ω~3KΩ
HAWR100	HAWR 100W	130	110	300	118	42	39	22.5	6	6	20	1Ω~3KΩ

### Performance Specifications (性能)

Operating temperature	工作温度范围	-55°C~+155°C
Temperature coefficient	温度系数	±350PPM
Short-time Overload	短时间过负荷	$\Delta R/R \leq \pm(5\%+0.05\Omega)$ , with no evidence of mechanical damage (无可见机械损伤)
Dielectric withstanding voltage	绝缘耐压	No evidence of flashover, mechanical damage.(2000V) (2000V, 无击穿、飞弧及可见机械损伤)
Resistance to soldering heat	耐焊接热	$\Delta R/R \pm(1\%+0.05\Omega)$
Temperature cycling	温度循环	$\Delta R/R \leq \pm(5\%+0.05\Omega)$ , with no evidence of mechanical damage (无可见机械损伤)
Humidity (Steady State)	恒定湿热	$\Delta R/R \leq \pm(5\%+0.05\Omega)$ , with no evidence of mechanical damage (无可见机械损伤)
Load life	负载寿命	$\Delta R/R \leq \pm(5\%+0.05\Omega)$ , with no evidence of mechanical damage (无可见机械损伤)

The length "L3" can be designed according to customer's requirement (长"L3"可根据客户要求特殊制作)

### Ordering Procedure (Example:HAWR 100W 5% 100E T/B-1000)

订购方式(例如: HAWR 100W 5% 100E T/B-1000)

**H A W R 0 0 J 0 1 0 1 1 0 0**

**Product Type (产品类型):**  
HAWR= High Power Wire Wound Boat form Fixed Resistor (高功率绕线船形固定电阻器)

**Wattage (功率):**  
60=60W 80=80W  
00=for power rating over 100W, please indicate the power rating at the last 3 digits of the part No.(大于100W 用料号后面的三位数字表面功率)

**Tolerance (公差):**  
J = ±5%

**Resistance Value (阻值):**  
E-24 series: the 1<sup>st</sup> digit will be "0", the 2<sup>nd</sup> & 3<sup>rd</sup> digits are for the significant figures of the resistance and the 4<sup>th</sup> digit denotes number of zeros following:  
E-24 系列阻值: 第1位数是0, 第2、3位数表示阻值的有效数, 第4位表示有几个0;

**Additional Information (注):**  
100 = 100W

Feature (特性)

- Anti-vibration, high stability  
优异的抗震性和稳定性
- Easy to assembled on PCB  
易于在 PCB 上安装
- Application: Electric device  
应用于电气设备

Derating Curve (降功率曲线)

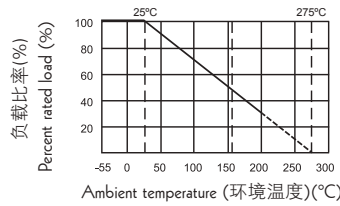

Dimension (尺寸)(mm)

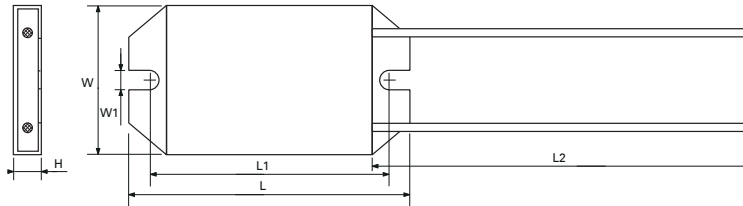

Type 类型	L±1.0	L1±0.5	L2 <sup>+20</sup> <sub>-0</sub>	W±0.5	W1±0.2	H±0.5	Resistance Range 阻值范围
HPWR40W	85	72	300	45	5.5	8.2	1Ω~100Ω

Specification (性能)

Operating temperature	工作温度范围	-55°C~+155°C
Temperature coefficient	温度系数	±300PPM
Short-time Overload	短时间过负荷	ΔR/R ≤ ±(5%+0.05Ω), 10 times power rating for 5s, with no evidence of mechanical damage (10 倍額功率 5 秒, 無可見機械損傷)
Dielectric withstanding voltage	绝缘耐压	No evidence of flashover, mechanical damage. (3000V) (3000V, 無擊穿、飛弧及可見機械損傷)
Resistance to soldering heat	耐焊接热	ΔR/R ≤ ±(1%+0.05 Ω)
Temperature cycling	温度循环	ΔR/R ≤ ±(5%+0.05Ω), with no evidence of mechanical damage (無可見機械損傷)
Humidity (Steady State)	恒定湿热	ΔR/R ≤ ±(5%+0.05Ω), with no evidence of mechanical damage (無可見機械損傷)
Load life	负载寿命	ΔR/R ≤ ±(5%+0.05Ω), room temperature, 1.5H "ON"/0.5H "OFF", with no evidence of mechanical damage (室温下 1.5 小時通, 0.5 小時斷, 無可見機械損傷)

Ordering Procedure (Example: HPWR 40W 5% 50Ω T/B-1000)

订购方式 (例如: HPWR 40W 5% 50Ω T/B-1000)

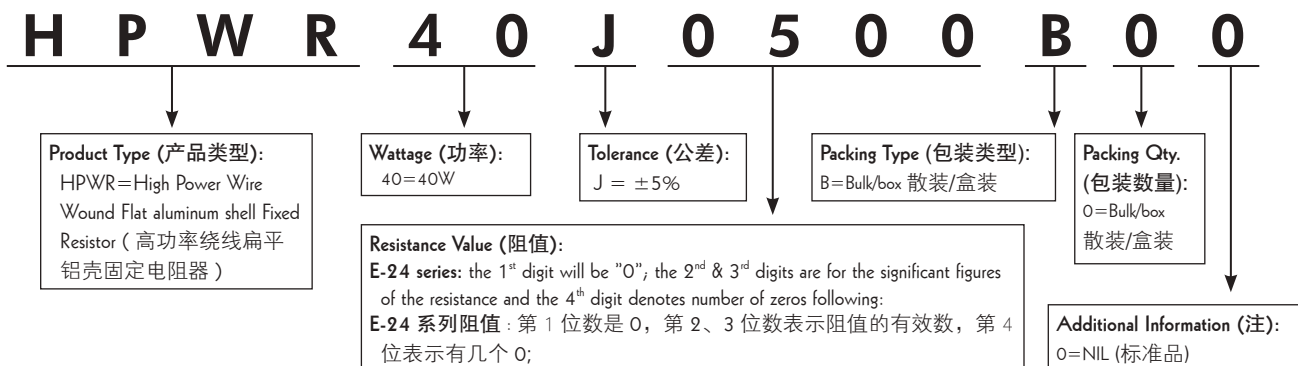

### Feature (特性)

- Anti-vibration, high stability  
优异的抗震性和稳定性
- Easy to assembled on PCB  
易于在 PCB 上安装
- Application: Electric device  
应用于电气设备

### Derating Curve (降功率曲线)

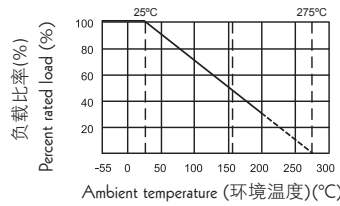

### Dimension (尺寸)(mm)

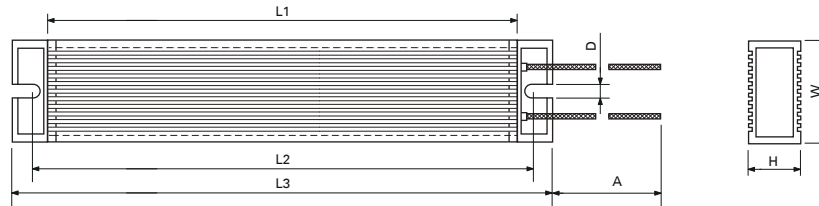

Type 类型	Dimension (尺寸) (mm)							Resistance Range 阻值范围
	A±10	L1±0.5	L2±0.5	L3±0.3	W±0.2	H±0.1	D±0.1	
HPAR 40W	300	50	80	62	40	20	5.2	1Ω~5KΩ
HPAR 60W	300	85	115	97	40	20	5.2	1Ω~10KΩ
HPAR 80W	300	110	140	122	40	20	5.2	1Ω~10KΩ
HPAR 100W	300	130	160	142	40	20	5.2	1Ω~12KΩ
HPAR 120W	300	155	190	172	40	20	5.2	1Ω~18KΩ
HPAR 150W	300	185	215	197	40	20	5.2	1Ω~20KΩ

### Specification (性能)

Operating temperature	工作温度范围	-55°C~+155°C
Temperature coefficient	温度系数	±350PPM
Short-time Overload	短时间过负荷	$\Delta R/R \leq \pm(5\% + 0.05\Omega)$ , 10 times power rating for 5s, with no evidence of mechanical damage (10 倍额定功率 5 秒, 無可見機械損傷)
Dielectric withstanding voltage	绝缘耐压	No evidence of flashover, mechanical damage. (3000V) (3000V, 無擊穿、飛弧及可見機械損傷)
Resistance to soldering heat	耐焊接热	$\Delta R/R \pm(1\% + 0.05\Omega)$
Temperature cycling	温度循环	$\Delta R/R \leq \pm(5\% + 0.05\Omega)$ , with no evidence of mechanical damage (無可見機械損傷)
Humidity (Steady State)	恒定湿热	$\Delta R/R \leq \pm(5\% + 0.05\Omega)$ , with no evidence of mechanical damage (無可見機械損傷)
Load life	负载寿命	$\Delta R/R \leq \pm(5\% + 0.05\Omega)$ , room temperature, 1.5H "ON" 0.5H "OFF", with no evidence of mechanical damage (室温下 1.5 小時通, 0.5 小時斷, 無可見機械損傷)

### Ordering Procedure (Example: HPAR 100W 5% 100Ω T/B-1000)

订购方式 (例如: HPAR 100W 5% 100Ω T/B-1000)

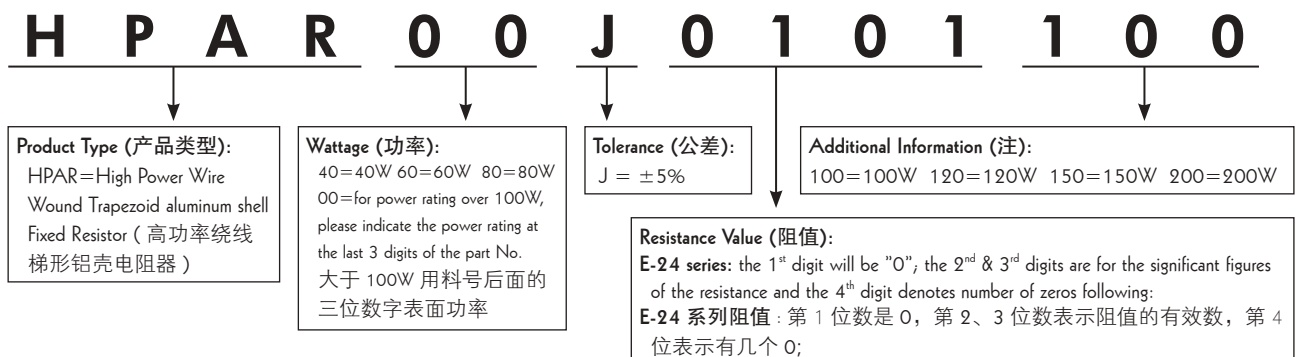

Feature (特性)

- Anti-vibration, high stability  
优异的抗震性和稳定性
- Easy to assembled on PCB  
易于在 PCB 上安装
- Application: Electric device  
应用于电气设备

Derating Curve (降功率曲线)

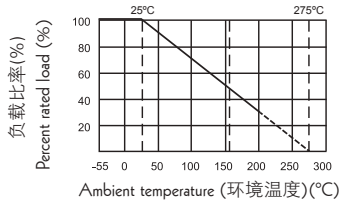

Dimension (尺寸)(mm)

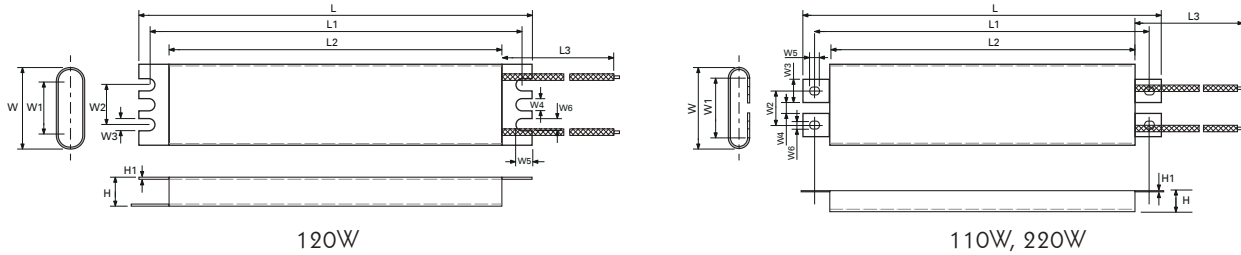

Type 类型	L <sub>5</sub> <sup>+0</sup>	L1±0.5	L2 <sup>+0.5</sup> <sub>-0</sub>	L3±5	W±0.5	W1±0.1	W2±0.2	W3±0.2	W4±0.5	W5±0.05	W6±0.05	H1±0.05	H±0.5	Resistance Range 阻值范围
HPWR 110W	105	91.5	78	300	44.6	33	19	13	6	5.8	4.3	0.8	11.5	5Ω~100Ω
HPWR 120W	195	184	165	250	40	26	19	5.5	5.5	8.25	5.5	0.8	14	
HPWR 220W	200	187	170	250	44.6	33	19	13	6	5.8	4.3	0.8	11.5	

Specification (性能)

Operating temperature 工作温度范围	-55°C~+155°C
Temperature coefficient 温度系数	±300PPM
Short-time Overload 短时间过负荷	ΔR/R ≤ ±(5%+0.05Ω), 10 times power rating for 5s, with no evidence of mechanical damage (10 倍額功率 5 秒, 無可見機械損傷)
Dielectric withstanding voltage 绝缘耐压	No evidence of flashover, mechanical damage.(3000V) (3000V, 無擊穿、飛弧及可見機械損傷)
Resistance to soldering heat 耐焊接热	ΔR/R ≤ ±(1%+0.05 Ω)
Temperature cycling 温度循环	ΔR/R ≤ ±(5%+0.05Ω), with no evidence of mechanical damage (無可見機械損傷)
Humidity (Steady State) 恒定湿热	ΔR/R ≤ ±(5%+0.05Ω), with no evidence of mechanical damage (無可見機械損傷)
Load life 负载寿命	ΔR/R ≤ ±(5%+0.05Ω), room temperature, 1.5H "ON"0.5H"OFF", with no evidence of mechanical damage (室温下 1.5 小時通, 0.5 小時斷, 無可見機械損傷)

Ordering Procedure (Example:HPWR 100W 5% 100Ω T/B-1000)

订购方式 (例如: HPWR 100W 5% 100Ω T/B-1000)

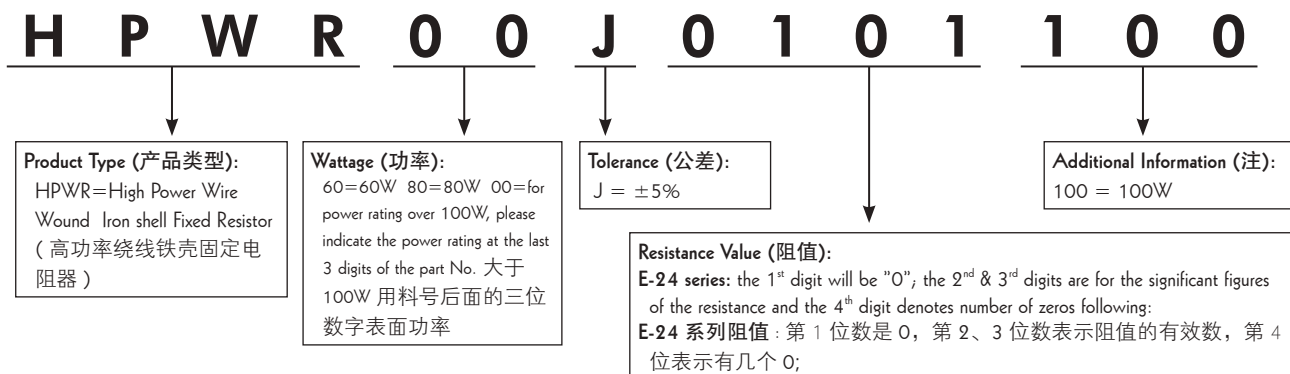



### Feature (特性)

- Flat resistor inside a zinc plated metallic case, composed by two coupled shells  
镀锌金属外壳，有两个耦合的组成平面电阻
- High insulative & heat-resistant performance 优异的绝缘性和耐热性
- Can withstand high overload current in short time 可短时间承受高过载电流
- Super heat dissipation, easy to assembled on PCB. 散热好，易于在PCB上安装
- Application: Charge resistor or step-down resistor in Electric device & Elevator, Inverter  
应用：电气设备和电梯专用变频器的充电电阻或降压电阻



### Dimension (尺寸) (mm)

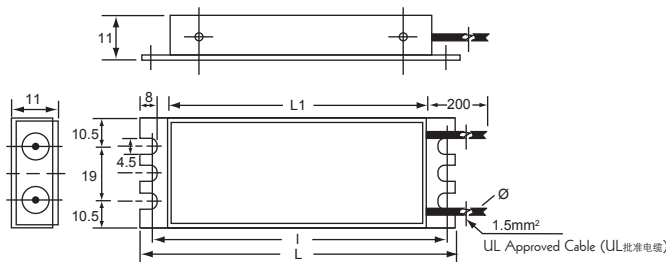

Type 类型	$L \pm 1$	$L \pm 1$	$L1 \pm 1$	$\varnothing \pm 0.05$	Remark 备注
HAWF100W	89	100	70	2.5	the cable can be specially designed according to customer's requirement 引出线可根据客户的要求特别定做
HAWF150W	134	145	115	2.5	
HAWF200W	184	195	165	2.5	

### Specification (性能)

Type 型号	HAWF100W	HAWF150W	HAWF200W
Nominal Power Rating 标称功率	50W	75W	100W
Power Rating for Mounted on the deck 安装在散热板上的功率	100W	150W	200W
Resistance Range 阻值范围	0.5Ω~2.5KΩ	0.5Ω~5KΩ	0.5Ω~7.5KΩ
Tolerance 公差	±5%	±5%	±5%
Dielectric Withstanding Voltage (50Hz, 1min) 绝缘耐压 (50赫兹, 1分钟)	3000V	3000V	3000V
Insulation resistance 绝缘电阻	1000MΩ	1000MΩ	1000MΩ
Time Constant 时间常数	≈8'	≈8'	≈8'
Energy absorbed in 5 seconds 5秒内能量的吸收	5.0KJ	7.5KJ	10KJ
Surface Temperature 表面温度	300°C	300°C	300°C

Feature (特性)

- Small size & sturdy mechanically safe 尺寸小、机械性能安全
- High safety standard 安全系数高
- Application: Motor cycle 应用：摩托车

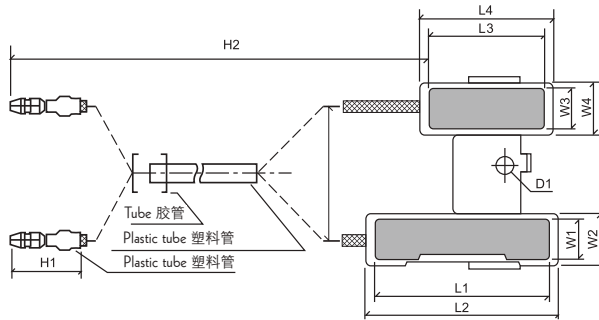
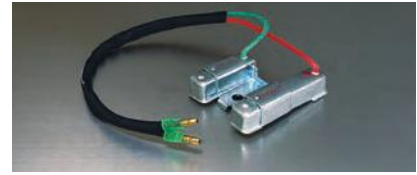

Derating Curve (降功率曲线)

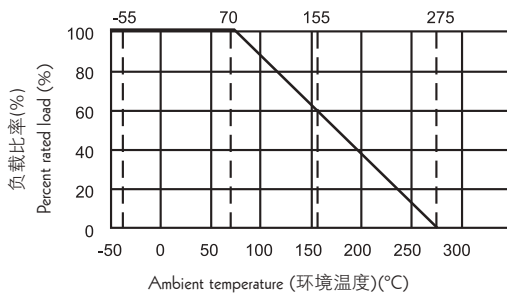

Dimension (尺寸) (mm)

Type 类型	L <sub>1</sub> +0.5	L <sub>2</sub> ±1	L <sub>3</sub> ±0.5	L <sub>4</sub> ±1	W <sub>1</sub> ±0.5	W <sub>2</sub> ±1	W <sub>3</sub> +0.5	W <sub>4</sub> +1	H <sub>1</sub> Max.	H <sub>2</sub> <sup>+10</sup> / <sub>-0</sub>	D <sub>1</sub> <sup>+0.5</sup> / <sub>-0</sub>	Resistance Range 阻值范围
BCR 20W+5W	64	66	42	44	13	15	13	15	30	250	6.5	0.5Ω - 100Ω

Performance Specifications (性能)

Temperature coefficient	温度系数	±400PPM/°C
Short-time overload	短时间过负荷	ΔR/R ≤ ±(5.0%+0.05Ω), with no evidence of mechanical damage (无可见机械损伤)
Dielectric withstanding voltage	绝缘耐压	No flashover, mechanical damage, arcing or insulation breakdown 无击穿、飞弧及可见机械损伤
Temperature cycling	温度循环	ΔR/R ≤ ±(5.0%+0.05Ω), with no evidence of mechanical damage (无可见机械损伤)
Humidity (Steady State)	恒定湿热	ΔR/R ≤ ±(5.0%+0.05Ω), with no evidence of mechanical damage (无可见机械损伤)
Load life in humidity	湿度寿命	ΔR/R ≤ ±(5.0%+0.05Ω), with no evidence of mechanical damage (无可见机械损伤)
Load life	负载寿命	ΔR/R ≤ ±(5.0%+0.05Ω), with no evidence of mechanical damage (无可见机械损伤)

### Feature (特性)

- High stable performance & power rating 稳定性好，功率高
- Safety flameproof construction, excellent moisture resistance 安全阻燃，防潮
- Application: applied to DC & AC low frequency circuit as step-down voltage, shunt or overload resistor in electrical equipment & instrument  
应用：适用于直流，交流降压电压，分流或超负荷电气设备及仪器的低频电路

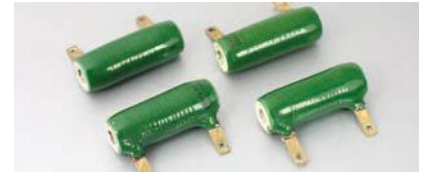

### Dimension (尺寸) (mm)

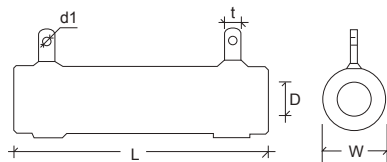

### Derating Curve (降功率曲线)

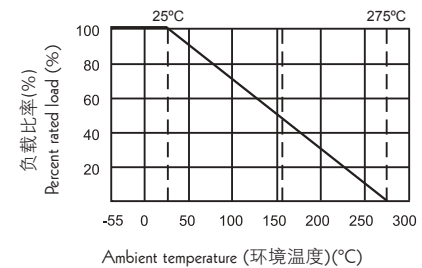

Type 规格	L	P	W	D	d1	t	Resistance Range 阻值范围 (±5% ±10%)
URX8W	35±1.5	23.5±1	14±2	5.5±0.4	2.0±0.1	4.5±0.1	1Ω-620Ω
URX10W	41±1.5	29.5±1	15±1	5.5±0.4	2.0±0.1	4.5±0.1	1Ω-620Ω
URX 15W	45±1.5	33.5±1	17±2	8±0.5	2.0±0.1	4.5±0.1	1Ω-910Ω
URX 20W	51±2	39.5±1	17±2	8±0.6	2.0±0.1	4.5±0.1	1Ω-1.1KΩ
URX 25W	51±2	39.5±1	21±2.5	12±0.8	2.0±0.1	4.5±0.1	1Ω-1.3KΩ
URX 30W	71±2.2	59.5±1	21±2.5	12±0.8	2.0±0.1	4.5±0.1	1Ω-2.2KΩ
URX 40W	87±2.2	75.5±1	21±2.5	12±0.8	2.0±0.1	4.5±0.1	1Ω-3KΩ
URX 50W	91±2.4	81±1	29±3	20±1	2.5±0.1	6.0±0.1	1Ω-4.3KΩ
URX 75W	140±3.2	129±1	29±3	20±1	2.5±0.1	6.0±0.1	1Ω-6.2KΩ
URX 100W	170±3.5	159±1	29±3	20±1	2.5±0.1	6.0±0.1	1Ω-8.2KΩ
URX 150W	215±3.5	205±1	29±3	20±1	2.5±0.1	6.0±0.1	1Ω-11KΩ

### Performance Specifications (性能)

Short-time overload	短时间过负荷	$\Delta R \leq \pm(1\%R + 0.05\Omega)$	10 times rated power rating, 5 seconds 施加10倍额定功率负荷5S
Shock	冲击	$\Delta R \leq (1\%R + 0.05\Omega)$	acceleration 390m/s <sup>2</sup> , 11ms, 18 times 加速度 390m/s <sup>2</sup> , 11ms, 18 次
Temperature quick change	温度快速变化	$\Delta R \leq (1\%R + 0.05\Omega)$	-55°C~+200°C, 5times cycling (5次循环)
Crash	碰撞	$\Delta R \leq (1\%R + 0.05\Omega)$	acceleration 390m/s <sup>2</sup> , 4000 times 加速度390m/s <sup>2</sup> , 4000 次
Terminal strength	端子强度	$\Delta R \leq (1\%R + 0.05\Omega)$	≤4.3W 10N, ≥6W 20N
Vibration	振动	$\Delta R \leq (1\%R + 0.05\Omega)$	Frequency 10-500HZ, acceleration 98m/s <sup>2</sup> 2.6h 频率10-500HZ, 加速度 98m/s <sup>2</sup> , 2.6h
Humidity (Steady State)	恒定湿热	$\Delta R \leq (5\%R + 0.05\Omega)$	Temperature 40±2°C, humidity 95—92% place 240Hr 温度 40±2°C, 湿度 95—92% 放置240小时
Load life	负载寿命	$\Delta R \leq (5\%R + 0.05\Omega)$	Rated power rating, 1000h, room temperature 室温施加额定负荷功率1000h
Solderability	可焊性	Min. 95% coverage (最少95%覆盖率)	245°C±3°C
Temperature rise	温升	<245°C	Rated power rating (施加额定负荷功率)

Derating Curve (降功率曲线)

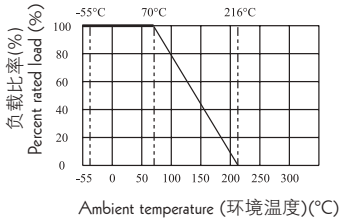

Circuit Structure (电路图)

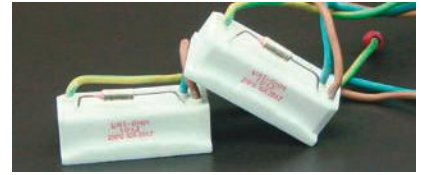
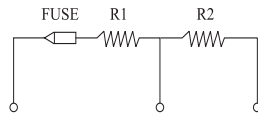

Dimension (尺寸) (mm)

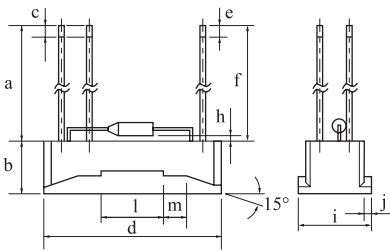

Performance Specifications (性能)

Type 类型	TFO 20W	a ± 5	125
Power rating at 70°C 功率	20W	b ± 1	16
Resistance 阻值范围	1.1 + 2.4Ω	c ± 1	5
Temperature coefficient 温度系数	± 350 PPM/°C	d ± 1	50
Fusing temperature TF 额定工作温度 TF	216°C	e ± 1	5
Rated current I <sub>r</sub> 额定电流 I <sub>r</sub>	10A	f ± 5	130
Rated voltage V <sub>r</sub> 额定电压 V <sub>r</sub>	250V	h ± 1	4
		i ± 1	24
		j ± 1	2.5
		l ± 1	15
		m ± 1	5

Feature (特性)

- Multi leads arrange encapsulation & space saving 多引线排列封装、节约空间
- Superior function of circuit overtemperature protection 良好的电路超温保护功能
- Excellent flame & moisture resistance 良好阻燃性、抗湿性
- Other ohmic value can be provided on a case to case basis 其它阻值也可以提供

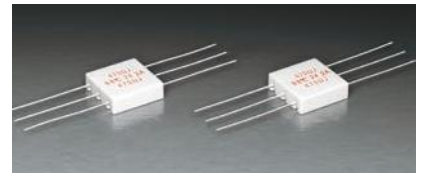

Derating Curve (降功率曲线)

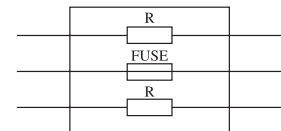
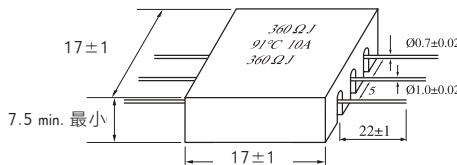
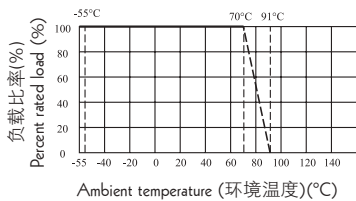

Type 类型	Power Rating 功率 (70°C)	Resistance Range 阻值范围	Tolerance 公差	Temperature Coefficient 温度系数 (PPM/°C)	Cut-off Temperature 额定动作温度 (°C)	Rated Current I <sub>r</sub> 额定电流 (A)	Rated Voltage U <sub>r</sub> 额定电压 (V)
TFRC 2W	2W	360+360Ω	± 5%	± 350	91	10	250

### Feature (特性)

- Multi-terminal types & variable types available  
多端子和多可调阻方式都可提供
- Small in size but capable of carrying high power load  
小体型负载大功率
- Resistance value unchanged after long use, good resistivity to short time overload  
长年使用不变阻值，短时间过负荷表现良好
- High resistivity to heat, small resistance temperature coefficient and the change in resistance with temperature being linear  
抗热，温度系数低，温度变化小
- Too low or high ohmic value can be supplied on a case to case basis  
超低或超高阻值都可特别提供
- Adjustable & Multi-Resistor type is available  
可调型与多阻型可提供
- Non-Inductive type is available  
可提供无感型



### Power Wire-wound Resistors - QH & QL Type

#### 功率型绕线电阻 – QH & QL 型

QH Type (QH 型)

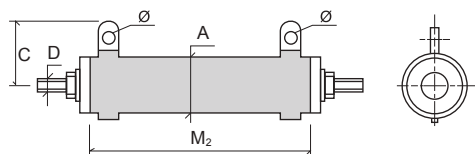

QL Type (QL 型)

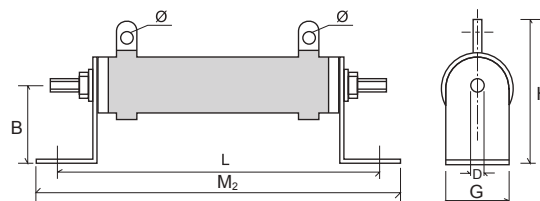

Part No. 料号	Wattage 功率	Dimension (尺寸) (mm)										Resistance Range 阻值范围
		A±1.5	B±1	C±1	D±1	G±1	L±2	M <sub>1</sub> ±2	M <sub>2</sub> ±2	H±1	Ø±0.1	
QH / QL0020	20W	19	19	19	4.5	18	81	91	50	38	2.5	1Ω~1KΩ
QH / QL0025	25W	19	19	19	4.5	18	91	101	60	38	2.5	2Ω~2KΩ
QH / QL0030	30W	19	19	19	4.5	18	106	116	75	38	3.5	2Ω~3KΩ
QH / QL0040	40W	19	19	19	4.5	18	121	131	90	38	3.5	2Ω~5KΩ
QH / QL0050	50W	31	27	31	4.5	26	106	126	75	58	4.5	3Ω~10KΩ
QH / QL0060	60W	31	27	31	4.5	26	121	141	90	58	4.5	3Ω~15KΩ
QH / QL0080	80W	31	27	31	4.5	26	146	166	115	58	4.5	3Ω~20KΩ
QH / QL00.....100	100W	31	27	31	4.5	26	171	191	140	58	4.5	3Ω~50KΩ
QH / QL00.....120	120W	31	27	31	4.5	26	196	216	165	58	5.5	4Ω~50KΩ
QH / QL00.....150	150W	31	27	31	4.5	26	226	246	195	58	5.5	4Ω~50KΩ
QH / QL00.....200	200W	31	27	31	4.5	26	286	306	254	58	5.5	5Ω~60KΩ
QH / QL00.....300	300W	42	38	38	5.5	40	290	324	254	79	5.5	8Ω~80KΩ
QH / QL00.....400	400W	42	38	38	5.5	40	365	400	330	79	5.5	10Ω~100KΩ
QH / QL00.....600	600W	42	38	38	5.5	40	456	490	420	79	5.5	10Ω~200KΩ

Power Ribbon Wire-wound Resistors - QR & QRZG Type

功率型绕线电阻 – QR & QRZG 型

QR Type (QR 型)

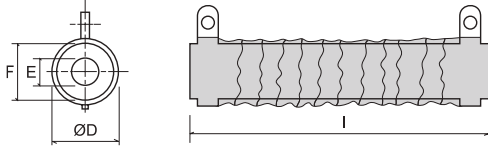

QRZG Type (QRZG 型)

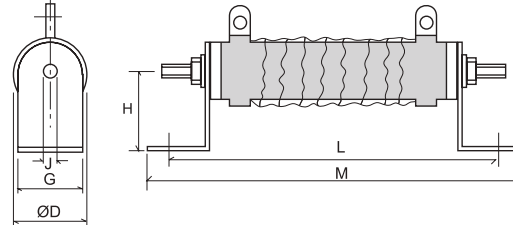

Part No. 料号	Wattage 功率	Dimension (尺寸)(mm)									Resistance Range 阻值范围
		ØD±2	E±1	F±1	G±1	H±1	J±1	L±1	L±2	M±2	
QR00.....120	120W	33	16	28	26	31	4.5	115	146	166	0.2Ω~4Ω
QRZG.....120											
QR00.....150	150W	33	16	28	26	31	4.5	140	171	191	0.3Ω~5Ω
QRZG.....150											
QR00.....180	180W	33	16	28	26	31	4.5	165	196	216	0.3Ω~6Ω
QRZG.....180											
QR00.....225	225W	33	16	28	26	31	4.5	195	226	246	0.4Ω~8Ω
QRZG.....225											
QR00.....300	300W	33	16	28	26	31	4.5	254	285	305	0.5Ω~10Ω
QRZG.....300											
QR00.....450	450W	48	25	40	40	38	5.5	254	290	324	0.8Ω~15Ω
QRZG.....450											
QR00.....600	600W	48	25	40	40	38	5.5	330	366	400	1Ω~20Ω
QRZG.....600											

Ordering Procedure (Example: QRZG 225W 5% 1.8Ω B/B)

订购方式 (例如: QRZG 225W 5% 1.8Ω B/B)

**Q R Z G 0 0 J 0 1 8 J 2 2 5**

**Product Type (产品类型):**  
 QH00 = QH Type (型)  
 QL00 = QL Type (型)  
 QR00 = QR Type (型)  
 QRZG = QRZG Type (型)

**Tolerance (公差):**  
 J = ±5%  
 K = ±10%

**Resistance Value (阻值):**  
 5%, 10% (E-24 series)  
 The 1<sup>st</sup> digit to denote production type:  
 W=Wire-wound type P=Power film type,  
 the 2<sup>nd</sup> & 3<sup>rd</sup> digits are for the significant  
 figures of the resistance and the 4<sup>th</sup> indicate  
 the number of zeros following  
 5% & 10% 产品 (E-24 系列阻值):  
 第 1 位数是 0, 第 2、3 位数表示阻  
 值的有效数, 第 4 位表示有几个 0;

**Additional Information (注):**  
 100 = 100W  
 120 = 120W  
 150 = 150W  
 180 = 180W  
 225 = 225W  
 300 = 300W  
 450 = 450W  
 600 = 600W

**Wattage (功率):**  
 20 = 20W, 25 = 25W, 30 = 30W, 40 = 40W, 50 = 50W, 60 = 60W, 80 = 80W  
 00 = for power rating over 100W, please indicate the power rating at the last 3 digits of the part No.  
 (00 = 功率超过 100 瓦, 但请注明功率于料号最后三位数)

JIS-C-5201和JIS-C-5202检测方法

<p><b>Temperature coefficient</b> 温度系数 (JIS-C-5201 4.8)</p>	<p>Natural resistance change per temperature degree centigrade 实际阻值随温度变化的变化率：  <math display="block">\frac{R_2 - R_1}{R_1(t_2 - t_1)} \times 10^6 \text{ (PPM / } ^\circ\text{C)}</math>                     R<sub>1</sub>: Resistance value at room temperature 室温下的阻值 (t<sub>1</sub>);                      R<sub>2</sub>: Resistance value at room temperature +100°C 室温加上 100°C 的阻值 (t<sub>2</sub>).                      Test pattern: Room temperature (t<sub>1</sub>), Room temperature +100°C (t<sub>2</sub>) 测试结构：室温 (t<sub>1</sub>), 室温 +100°C (t<sub>2</sub>)</p>
<p><b>Short-time overload</b> 短时间过负荷 (JIS-C-5201 4.13)</p>	<p>Permanent resistance change after the application of a potential of 2.5 times RCWV or Max. Overload Voltage whichever less for 5 seconds. 加 2.5 倍额定工作电压或最大过负荷电压 (取其低者), 持续 5 秒钟, 测阻值变化。</p>
<p><b>Insulation resistance</b> 绝缘阻值 (JIS-C-5201 4.6)</p>	<p>1. Chip Resistor: the measuring voltage shall be ,measured with a direct voltage of (100±15)V or a voltage equal to the dielectric withstanding voltage, and apply for 1min.                      2. TH Resistor: The measuring voltage shall be either(100±15) V DC for resistors with an insulation voltage &lt;500V or (500±50)V DC,for resistors with an isolation voltage≥500V.                      1. 贴片电阻：绝缘耐压 &lt;100V, 测试电压取绝缘耐压的电压；绝缘耐压 ≥100V, 测试电压为 100±15 VDC,1 分钟后量测阻值。                      2. 插件电阻：绝缘耐压 &lt;500V, 测试电压取绝缘耐压的电压；绝缘耐压 ≥500V, 测试电压为 500±50 VDC,1 分钟后量测阻值。</p>
<p><b>Dielectric withstanding voltage</b> 绝缘耐压 (JIS-C-5201 4.7)</p>	<p>Resistor shall be clamped in the trough of 90°C metallic V - block and shall be tested at AC potential respectively specified in the given list of each product type for 60-70 seconds. For Cement Fixed Resistors, the testing voltage is 1,000V.                      电阻固定在 90°C 的 V 型槽中, 根据不同产品规定交流电压, 持续 60~70 秒, 水泥型电阻电压设定为 1000V.</p>
<p><b>Pulse overload</b> 脉冲过负荷 (JIS-C-5201 4.28)</p>	<p>Resistance change after 10,000 cycles (1 second "ON", 25 seconds "OFF") at 4 times of RCWV or Max. Overload whichever less. 10,000 次循环后变化 (1 秒 "通"、25 秒断) 4 倍工作电压或最大工作电压 (取其最低者)。</p>
<p><b>Terminal strength</b> 端子强度 (JIS-C-5201 4.16)</p>	<p>Direct Load: Resistance at a 2.5kg direct load for 10 seconds in the direction of the longitudinal axis of the terminal leads.                      Twist Test: Terminal leads shall be bent through 90° at a point of about 6mm from the body of the resistor and shall be rotated through 360° about the original axis of the bent terminal in alternating direction for a total of 3 rotations.                      直接负荷：在电阻引线方向直接加 2.5 公斤力 10 秒。扭曲测试：两端导线折弯 90 度在熔点 6mm 处交替旋转 360 度 3 次。</p>
<p><b>Terminal strength</b> 端子强度 (JIS-C-5201 4.16)</p>	<p>(Applicable for Resistor Network 适用网络电阻)                      Tensile: 1KG, 30 seconds / Bending: 500g, 2 times 张力：1KG, 30 秒 / 弯曲：500g, 2 次。</p>
<p><b>Terminal bending</b> 端子弯曲 (JIS-C-5201 4.33)</p>	<p>(Applicable for CHIP Resistors 适用晶片电阻)                      Twist of Test Board: Y / X = 3/90mm 60 seconds. 测试板弯曲：Y / X = 3/90mm 60 秒。</p>
<p><b>Soldering heat</b> 耐焊接热 (JIS-C-5201 4.18)</p>	<p>(Applicable for CHIP Resistors 适用晶片电阻)                      Dip the resistor into a solder bath having a temperature of 260±5°C and hold it for a 10±1 seconds.                      将电阻浸入 260±5°C 锡炉 10±1 秒。</p>
<p><b>Soldering heat</b> 耐焊接热 (JIS-C-5201 4.18)</p>	<p>(Applicable for TH Resistors 适用插件电阻)                      Permanent resistor change when leads immersed to a point 2.0~2.5mm from the body in 260±5°C solder 10±1 seconds.                      锡炉温度 260±5°C, 浸入深度：离本体导线根部约 2.0~2.5mm, 处浸入时间 10±1 秒。</p>
<p><b>Solderability</b> 可焊性 (JIS-C-5201 4.17)</p>	<p>The area covered with a new, smooth, clean, shiny and continuous surface free from concentrated pinholes. Temperature of solder: 245±3°C;                      Dwell time in solder: 2-3 seconds.                      表面光滑、清洁、均匀、有光泽, 锡炉温度：245±3°C, 浸入时间：2-3 秒。</p>
<p><b>Resistance to solvent</b> 耐溶剂 (JIS-C-5201 4.29)</p>	<p>Specimens shall be immersed in a bath of alcohol completely for a 3 mintues using ultrasonic test equipment.                      电阻浸入异丙醇超声波清洗 3 分钟。</p>
<p><b>Thermal shock</b> 热冲击 (JIS-C-5201 4.21)</p>	<p>(Applicable for Resistor Network 适用于网络电阻)                      Load V, Room temperature, 30 minutes. Unload, -55°C, 15 minutes. Over 2 hours in room temperature before measuring.                      加电压：室温 30 分钟。不加电压：-55°C, 15 分钟。室温下过 2 小时测量变化率。</p>
<p><b>Temperature cycling</b> 温度循环 (JIS-C-5201 4.19)</p>	<p>Resistance change after continuous 5 cycles for duty cycle specified below                      Step 1: 30 mintues at -55±3°C                      Step 2: 10~15 minutes at Room temperature                      Step 3: 30 mintues at 155±2°C                      Step 4: 10~15 minutes at Room temperature                      连续 5 次温度循环 (如下所示) 步骤                      步骤 1: 温度：-55±3°C 时间：30 分钟                      步骤 2: 温度：室温 时间：10~15 分钟                      步骤 3: 温度：155±2°C 时间：30 分钟                      步骤 4: 温度：室温 时间：10~15 分钟</p>
<p><b>Humidity (Steady State)</b> 恒定湿热 (JIS-C-5201 4.24)</p>	<p>Temporary resistance change after 240 hours exposure in a humidity test chamber controlled at 40±2°C and 90-95% RH.                      在 40±2°C 和 90-95%RH 相对湿度条件下, 存放 240 小时后阻值变化率。</p>
<p><b>Load life in humidity</b> 湿度寿命 (JIS-C 5202 7.9)</p>	<p>Resistance change after 1,000 hours (1.5 hours "ON", 0.5 hours "OFF") at RCWV or Max. Working Voltage whichever less in a humidity test chamber controlled at 40±2°C and 90~95% RH. 持续时间：1,000 小时 (1.5 小时 "通", 0.5 小时 "断"); 试验温度：40±2°C; 相对湿度：90~95%RH; 试验电压：额定工作电压或最大工作电压 (取其低者)。</p>
<p><b>Load life</b> 负载寿命 (JIS-C-5201 4.25.1)</p>	<p>Permanent resistance change after 1,000 hours operating at RCWV or Max. Working Voltage whichever less with duty cycle of 1.5 hours "ON", 0.5 hours "OFF" at 70±2°C ambient 持续时间：1,000 小时 (1.5 小时 "通", 0.5 小时 "断"); 试验温度：70±2°C; 试验电压：额定工作电压或最大工作电压 (取其低者)。</p>
<p><b>Accidental overload</b> 意外过载 (JIS-C-5201 4.26)</p>	<p>Resistors shall resist flaming or arcing when overload up to 5, 10, 16, 25, 40, 63, 100 times power or 4times Max. Working Voltage, whichever less. 施加 5, 10, 16, 25, 40, 63 和 100 倍额定功耗的过负荷, 但所加的电压应不超过 4 倍的最大工作电压, 测试其阻燃性。</p>
<p><b>Flame retardant</b> 阻燃 (JIS-C-5202 7.12)</p>	<p>(Applicable for Flame retardant Resistors) The burner is placed remote from resistor ignited and adjusted to produce a blue flame 38mm in height and a top of flame 127mm above teh top of burner tube. Resistor is supported from its lead at 45°from the horizontal so that the lower end of resistor is the top of blue flame. The test flame is placed to remain for 15 seconds and removed for 15 seconds. The operation is to be repeated until resistor has been subjected to 5 application of test flame.                      (适用不燃性电阻) 将电阻置于火焰上方蓝烟处 38mm 或火上 127mm 处, 并与水平成 45 度角, 保持 15 秒, 移开 15 秒, 重复 5 次。</p>

\*\* RCWV = Rated Continuous Working Voltage =  $\sqrt{\frac{\text{Rated Power} \times \text{Resistance Value}}{\text{额定功率} \times \text{阻值}}}$  the calculated value or the Max. Working Voltage whichever less. 计算值或该产品最大工作电压取其低者

The below chart shows the nominal resistance value for each series. The values in the chart have been in this order using the approximate values that are based on the common ratios given in the following table:

下表列出每种系列的标准阻值，表中的阻值是按照通用倍率得出的接近阻值。

Series 系列	Common Ratio 通用倍率	Remarks 备注
E-6	$\sqrt[6]{10}(1.46)$	Rounded off to a 2-digit figure (2 位有效数字)
E-12	$\sqrt[12]{10}(1.21)$	Rounded off to a 2-digit figure (2 位有效数字)
E-24	$\sqrt[24]{10}(1.10)$	Rounded off to a 2-digit figure (2 位有效数字)
E-96	$\sqrt[96]{10}(1.02)$	Rounded off to a 3-digit figure (3 位有效数字)

E-6	E-12	E-24	E-96	E-6	E-12	E-24	E-96	E-6	E-12	E-24	E-96				
1.0	1.0	1.0	1.00	2.2	2.2	2.2	2.15	4.7	4.7	4.7	4.64				
			1.02				2.21				4.75				
			1.05				2.26				4.87				
			1.07				2.32				4.99				
		1.1	1.10			2.4	2.37				5.1	5.11			
			1.13				2.43					5.23			
			1.15				2.49					5.36			
			1.18				2.55					5.49			
			1.2				1.2					1.2	2.61	5.6	5.62
													2.67		5.76
													2.74		5.90
													2.80		6.04
	1.3			1.3	3.0		2.87			6.2		6.19			
							2.94					6.34			
							3.01					6.49			
							3.09					6.65			
	1.5	1.5	1.5	3.16	6.8	6.8	6.81								
				3.24			6.98								
				3.32			7.15								
				3.40			7.32								
			1.6	1.6			1.6			3.48	7.5	7.50			
										3.57		7.68			
										3.65		7.87			
										3.74		8.06			
1.8								1.8	1.8	3.83		8.2	8.25		
										3.92			8.45		
				4.02			8.66								
				4.12			8.87								
		2.0		2.0			2.0			4.22			9.1	9.09	
										4.32				9.31	
4.42								9.53							
4.53								9.76							



标准阻值

E-24 series standard resistance value & the codes to be used in the part No. system 5% & 10% tolerance (4 digits, start with "0"):

E-24 系列标准阻值和料号系统使用代码 (4 位, 以 0 为首位, 5%、10% 公差):

Value 阻值	Code 代码	Value 阻值	Code 代码	Value 阻值	Code 代码	Value 阻值	Code 代码	Value 阻值	Code 代码	Value 阻值	Code 代码	Value 阻值	Code 代码
1.0Ω	010J	10Ω	0100	100Ω	0101	1.0KΩ	0102	10KΩ	0103	100KΩ	0104	1.0MΩ	0105
1.1Ω	011J	11Ω	0110	110Ω	0111	1.1KΩ	0112	11KΩ	0113	110KΩ	0114	1.1MΩ	0115
1.2Ω	012J	12Ω	0120	120Ω	0121	1.2KΩ	0122	12KΩ	0123	120KΩ	0124	1.2MΩ	0125
1.3Ω	013J	13Ω	0130	130Ω	0131	1.3KΩ	0132	13KΩ	0133	130KΩ	0134	1.3MΩ	0135
1.5Ω	015J	15Ω	0150	150Ω	0151	1.5KΩ	0152	15KΩ	0153	150KΩ	0154	1.5MΩ	0155
1.6Ω	016J	16Ω	0160	160Ω	0161	1.6KΩ	0162	16KΩ	0163	160KΩ	0164	1.6MΩ	0165
1.8Ω	018J	18Ω	0180	180Ω	0181	1.8KΩ	0182	18KΩ	0183	180KΩ	0184	1.8MΩ	0185
2.0Ω	020J	20Ω	0200	200Ω	0201	2.0KΩ	0202	20KΩ	0203	200KΩ	0204	2.0MΩ	0205
2.2Ω	022J	22Ω	0220	220Ω	0221	2.2KΩ	0222	22KΩ	0223	220KΩ	0224	2.2MΩ	0225
2.4Ω	024J	24Ω	0240	240Ω	0241	2.4KΩ	0242	24KΩ	0243	240KΩ	0244	2.4MΩ	0245
2.7Ω	027J	27Ω	0270	270Ω	0271	2.7KΩ	0272	27KΩ	0273	270KΩ	0274	2.7MΩ	0275
3.0Ω	030J	30Ω	0300	300Ω	0301	3.0KΩ	0302	30KΩ	0303	300KΩ	0304	3.0MΩ	0305
3.3Ω	033J	33Ω	0330	330Ω	0331	3.3KΩ	0332	33KΩ	0333	330KΩ	0334	3.3MΩ	0335
3.6Ω	036J	36Ω	0360	360Ω	0361	3.6KΩ	0362	36KΩ	0363	360KΩ	0364	3.6MΩ	0365
3.9Ω	039J	39Ω	0390	390Ω	0391	3.9KΩ	0392	39KΩ	0393	390KΩ	0394	3.9MΩ	0395
4.3Ω	043J	43Ω	0430	430Ω	0431	4.3KΩ	0432	43KΩ	0433	430KΩ	0434	4.3MΩ	0435
4.7Ω	047J	47Ω	0470	470Ω	0471	4.7KΩ	0472	47KΩ	0473	470KΩ	0474	4.7MΩ	0475
5.1Ω	051J	51Ω	0510	510Ω	0511	5.1KΩ	0512	51KΩ	0513	510KΩ	0514	5.1MΩ	0515
5.6Ω	056J	56Ω	0560	560Ω	0561	5.6KΩ	0562	56KΩ	0563	560KΩ	0564	5.6MΩ	0565
6.2Ω	062J	62Ω	0620	620Ω	0621	6.2KΩ	0622	62KΩ	0623	620KΩ	0624	6.2MΩ	0625
6.8Ω	068J	68Ω	0680	680Ω	0681	6.8KΩ	0682	68KΩ	0683	680KΩ	0684	6.8MΩ	0685
7.5Ω	075J	75Ω	0750	750Ω	0751	7.5KΩ	0752	75KΩ	0753	750KΩ	0754	7.5MΩ	0755
8.2Ω	082J	82Ω	0820	820Ω	0821	8.2KΩ	0822	82KΩ	0823	820KΩ	0824	8.2MΩ	0825
9.1Ω	091J	91Ω	0910	910Ω	0911	9.1KΩ	0912	91KΩ	0913	910KΩ	0914	9.1MΩ	0915
												10MΩ	0106

E-96 series standard resistance value & the codes to be used in the part No. system not over 2% tolerance (4 digits):

E-96 系列标准阻值和料号系统使用代码 (4 位, 0.1%、0.25%、0.5%、1%、2% 公差):

Value 阻值	Code 代码	Value 阻值	Code 代码	Value 阻值	Code 代码	Value 阻值	Code 代码	Value 阻值	Code 代码	Value 阻值	Code 代码	Value 阻值	Code 代码	Value 阻值	Code 代码
10.0Ω	100J	17.8Ω	178J	31.6Ω	316J	56.2Ω	562J	100Ω	1000	178Ω	1780	316Ω	3160	562Ω	5620
10.2Ω	102J	18.2Ω	182J	32.4Ω	324J	57.6Ω	576J	102Ω	1020	182Ω	1820	324Ω	3240	576Ω	5760
10.5Ω	105J	18.7Ω	187J	33.2Ω	332J	59.0Ω	590J	105Ω	1050	187Ω	1870	332Ω	3320	590Ω	5900
10.7Ω	107J	19.1Ω	191J	34.0Ω	340J	60.4Ω	604J	107Ω	1070	191Ω	1910	340Ω	3400	604Ω	6040
11.0Ω	110J	19.6Ω	196J	34.8Ω	348J	61.9Ω	619J	110Ω	1100	196Ω	1960	348Ω	3480	619Ω	6190
11.3Ω	113J	20.0Ω	200J	35.7Ω	357J	63.4Ω	634J	113Ω	1130	200Ω	2000	357Ω	3570	634Ω	6340
11.5Ω	115J	20.5Ω	205J	36.5Ω	365J	64.9Ω	649J	115Ω	1150	205Ω	2050	365Ω	3650	649Ω	6490
11.8Ω	118J	21.0Ω	210J	37.4Ω	374J	66.5Ω	665J	118Ω	1180	210Ω	2100	374Ω	3740	665Ω	6650
12.1Ω	121J	21.5Ω	215J	38.3Ω	383J	68.1Ω	681J	121Ω	1210	215Ω	2150	383Ω	3830	681Ω	6810
12.4Ω	124J	22.1Ω	221J	39.2Ω	392J	69.8Ω	698J	124Ω	1240	221Ω	2210	392Ω	3920	698Ω	6980
12.7Ω	127J	22.6Ω	226J	40.2Ω	402J	71.5Ω	715J	127Ω	1270	226Ω	2260	402Ω	4020	715Ω	7150
13.0Ω	130J	23.2Ω	232J	41.2Ω	412J	73.2Ω	732J	130Ω	1300	232Ω	2320	412Ω	4120	732Ω	7320
13.3Ω	133J	23.7Ω	237J	42.2Ω	422J	75.0Ω	750J	133Ω	1330	237Ω	2370	422Ω	4220	750Ω	7500
13.7Ω	137J	24.3Ω	243J	43.2Ω	432J	76.8Ω	768J	137Ω	1370	243Ω	2430	432Ω	4320	768Ω	7680
14.0Ω	140J	24.9Ω	249J	44.2Ω	442J	78.7Ω	787J	140Ω	1400	249Ω	2490	442Ω	4420	787Ω	7870
14.3Ω	143J	25.5Ω	255J	45.3Ω	453J	80.6Ω	806J	143Ω	1430	255Ω	2550	453Ω	4530	806Ω	8060
14.7Ω	147J	26.1Ω	261J	46.4Ω	464J	82.5Ω	825J	147Ω	1470	261Ω	2610	464Ω	4640	825Ω	8250
15.0Ω	150J	26.7Ω	267J	47.5Ω	475J	84.5Ω	845J	150Ω	1500	267Ω	2670	475Ω	4750	845Ω	8450
15.4Ω	154J	27.4Ω	274J	48.7Ω	487J	86.6Ω	866J	154Ω	1540	274Ω	2740	487Ω	4870	866Ω	8660
15.8Ω	158J	28.0Ω	280J	49.9Ω	499J	88.7Ω	887J	158Ω	1580	280Ω	2800	499Ω	4990	887Ω	8870
16.2Ω	162J	28.7Ω	287J	51.1Ω	511J	90.9Ω	909J	162Ω	1620	287Ω	2870	511Ω	5110	909Ω	9090
16.5Ω	165J	29.4Ω	294J	52.3Ω	523J	93.1Ω	931J	165Ω	1650	294Ω	2940	523Ω	5230	931Ω	9310
16.9Ω	169J	30.1Ω	301J	53.6Ω	536J	95.3Ω	953J	169Ω	1690	301Ω	3010	536Ω	5360	953Ω	9530
17.4Ω	174J	30.9Ω	309J	54.9Ω	549J	97.6Ω	976J	174Ω	1740	309Ω	3090	549Ω	5490	976Ω	9760

Value 阻值	Code 代码	Value 阻值	Code 代码	Value 阻值	Code 代码	Value 阻值	Code 代码	Value 阻值	Code 代码	Value 阻值	Code 代码	Value 阻值	Code 代码	Value 阻值	Code 代码
1.00K	1001	2.37K	2371	5.62K	5621	13.3K	1332	31.6K	3162	75.0K	7502	178K	1783	422K	4223
1.02K	1021	2.43K	2431	5.76K	5761	13.7K	1372	32.4K	3242	76.8K	7682	182K	1823	432K	4323
1.05K	1051	2.49K	2491	5.90K	5901	14.0K	1402	33.2K	3322	78.7K	7872	187K	1873	442K	4423
1.07K	1071	2.55K	2551	6.04K	6041	14.3K	1432	34.0K	3402	80.6K	8062	191K	1913	453K	4533
1.10K	1101	2.61K	2611	6.19K	6191	14.7K	1472	34.8K	3482	82.5K	8252	196K	1963	464K	4643
1.13K	1131	2.67K	2671	6.34K	6341	15.0K	1502	35.7K	3572	84.5K	8452	200K	2003	475K	4753
1.15K	1151	2.74K	2741	6.49K	6491	15.4K	1542	36.5K	3652	86.6K	8662	205K	2053	487K	4873
1.18K	1181	2.80K	2801	6.65K	6651	15.8K	1582	37.4K	3742	88.7K	8872	210K	2103	499K	4993
1.21K	1211	2.87K	2871	6.81K	6811	16.2K	1622	38.3K	3832	90.9K	9092	215K	2153	511K	5113
1.24K	1241	2.94K	2941	6.98K	6981	16.5K	1652	39.2K	3922	93.1K	9312	221K	2213	523K	5233
1.27K	1271	3.01K	3011	7.15K	7151	16.9K	1692	40.2K	4022	95.3K	9532	226K	2263	536K	5363
1.30K	1301	3.09K	3091	7.32K	7321	17.4K	1742	41.2K	4122	97.6K	9762	232K	2323	549K	5493
1.33K	1331	3.16K	3161	7.50K	7501	17.8K	1782	42.2K	4222	100K	1003	237K	2373	562K	5623
1.37K	1371	3.24K	3241	7.68K	7681	18.2K	1822	43.2K	4322	102K	1023	243K	2433	576K	5763
1.40K	1401	3.32K	3321	7.87K	7871	18.7K	1872	44.2K	4422	105K	1053	249K	2493	590K	5903
1.43K	1431	3.40K	3401	8.06K	8061	19.1K	1912	45.3K	4532	107K	1073	255K	2553	604K	6043
1.47K	1471	3.48K	3481	8.25K	8251	19.6K	1962	46.4K	4642	110K	1103	261K	2613	619K	6193
1.50K	1501	3.57K	3571	8.45K	8451	20.0K	2002	47.5K	4752	113K	1133	267K	2673	634K	6343
1.54K	1541	3.65K	3651	8.66K	8661	20.5K	2052	48.7K	4872	115K	1153	274K	2743	649K	6493
1.58K	1581	3.74K	3741	8.87K	8871	21.0K	2102	49.9K	4992	118K	1183	280K	2803	665K	6653
1.62K	1621	3.83K	3831	9.09K	9091	21.5K	2152	51.1K	5112	121K	1213	287K	2873	681K	6813
1.65K	1651	3.92K	3921	9.31K	9311	22.1K	2212	52.3K	5232	124K	1243	294K	2943	698K	6983
1.69K	1691	4.02K	4021	9.53K	9531	22.6K	2262	53.6K	5362	127K	1273	301K	3013	715K	7153
1.74K	1741	4.12K	4121	9.76K	9761	23.2K	2322	54.9K	5492	130K	1303	309K	3093	732K	7323
1.78K	1781	4.22K	4221	10.0K	1002	23.7K	2372	56.2K	5622	133K	1333	316K	3163	750K	7503
1.82K	1821	4.32K	4321	10.2K	1022	24.3K	2432	57.6K	5762	137K	1373	324K	3243	768K	7683
1.87K	1871	4.42K	4421	10.5K	1052	24.9K	2492	59.0K	5902	140K	1403	332K	3323	787K	7873
1.91K	1911	4.53K	4531	10.7K	1072	25.5K	2552	60.4K	6042	143K	1433	340K	3403	806K	8063
1.96K	1961	4.64K	4641	11.0K	1102	26.1K	2612	61.9K	6192	147K	1473	348K	3483	825K	8253
2.00K	2001	4.75K	4751	11.3K	1132	26.7K	2672	63.4K	6342	150K	1503	357K	3573	845K	8453
2.05K	2051	4.87K	4871	11.5K	1152	27.4K	2742	64.9K	6492	154K	1543	365K	3653	866K	8663
2.10K	2101	4.99K	4991	11.8K	1182	28.0K	2802	66.5K	6652	158K	1583	374K	3743	887K	8873
2.15K	2151	5.11K	5111	12.1K	1212	28.7K	2872	68.1K	6812	162K	1623	383K	3833	909K	9093
2.21K	2211	5.23K	5231	12.4K	1242	29.4K	2942	69.8K	6982	165K	1653	392K	3923	931K	9313
2.26K	2261	5.36K	5361	12.7K	1272	30.1K	3012	71.5K	7152	169K	1693	402K	4023	953K	9533
2.32K	2321	5.49K	5491	13.0K	1302	30.9K	3092	73.2K	7322	174K	1743	412K	4123	976K	9763
														1M	1004

\*\* All values shown above are standard resistance values, other values could also be provided on a case to case basis (MOQ requested)

\*\* 以上所有阻值都是标准阻值, 其他阻值可以特别提供, 但有相应 MOQ 之要求。

料号系统注释



The standard Part No. includes 14 digits with the following explanation (标准料号包括 14 位数字, 注释如下):

1. 1<sup>st</sup>~4<sup>th</sup> digits (第 1 位 ~ 第 4 位):
  - a) This is to indicate the SMD Resistor size. Example (表示晶片电阻的尺寸, 例如): 1206, TC05 or HV03;
  - b) For Resistor Network & Coated type, the 1<sup>st</sup>~3<sup>rd</sup> digits are to indicate the product type and the 4<sup>th</sup> digit is the special feature. Example: RNLA = Resistor Network Circuit A type; CFRF = Carbon Film Fixed Resistors Non-Flame type; MORI = Metal Oxide Film Fixed Resistor Non-Inductive type.  
网络电阻和涂装型电阻第 1 位到第 3 位表示产品类型, 第 4 位表示特殊形态, 如: RNLA = 网络电阻 A 型; CFRF = 不燃性碳膜电阻器; MORI = 无感型金属氧化膜电阻器。
  - c) For Cement Fixed Resistors, these 4 digits are to indicate the product type but if the product type has only 3 digits, the 4<sup>th</sup> digit will be "0". Example: PRW0=PRW type; PRWC=PRWC type.  
水泥型前 4 位表示产品类型, 如果产品只有 3 个字母, 第 4 位为 0, 例: PRW0=PRW 型, PRWC=PRWC 型。

2. 5<sup>th</sup>~ 6<sup>th</sup> digits (第 5 位 ~ 第 6 位):
  - a) This is to indicate the wattage or power rating. To distinguish the sizes and the numbers, the following codes are used, and please refer to the following chart for details: W = Normal Size, S = Small Size, U = Ultra Small Size, "1" ~ "G" to denotes "1" ~ "16" as Hexadecimal:  
表示产品标识功率, 为区别不同尺寸, 同时使用以下字母, 如: W = 正常尺寸; S = 小尺寸; U = 超小尺寸; "1" ~ "G" 代表 "1" ~ "16" 为 16 进制。

1/16W ~ 1/2W (<1W)

Wattage 功率	1/2	1/3	1/4	1/5	1/6	1/7	1/8	1/9	1/10	1/11	1/12	1/13	1/14	1/15	1/16
Normal Size 正常尺寸	W2	W3	W4	W5	W6	W7	W8	W9	WA	WB	WC	WD	WE	WF	WG
Small Size 小尺寸	S2	S3	S4	S5	S6	S7	S8	S9	SA	SB	SC	SD	SE	SF	SG
Ultra Small Size 超小尺寸	U2	U3	U4	U5	U6	U7	U8	U9	UA	UB	UC	UD	UE	UF	UG

1W ~ 16W (≥1W)

Wattage 功率	1	2	3	4	5	6	7	8	9	10	11	12	13	14	15	16
Normal Size 正常尺寸	1W	2W	3W	4W	5W	6W	7W	8W	9W	AW	BW	CW	DW	EW	FW	GW
Small Size 小尺寸	1S	2S	3S	4S	5S	6S	7S	8S	9S	AS	BS	CS	DS	ES	FS	GS
Ultra Small Size 超小尺寸	1U	2U	3U	4U	5U	6U	7U	8U	9U	AU	BU	CU	DU	EU	FU	GU

- b) For power rating less than 1W, the 5<sup>th</sup> digit will be the letters W, S or U to represent the size required & the 6<sup>th</sup> digit will be a number or a letter code. Example: WA = 1/10W; U2 = 1/2W-SS (功率小于 1 瓦, 第 5 位用 W, S 或 U 表示尺寸要求, 第 6 位将是数字或字母, 例: WA = 1/10W; U2 = 1/2W-SS.)
  - c) For power rating of 1W to 16W, the 5<sup>th</sup> digit will be a number or a letter code and the 6<sup>th</sup> digit will be the letters of W, S or U. Example: AW = 10W; 3S = 3W-S. 当功率为 1 到 16 瓦, 第 5 位将是数字或字母, 第 6 位是 W, S 或 U. 例: AW = 10W; 3S = 3W-S.
  - d) For power rating between 20W to 99W, the 5<sup>th</sup> & 6<sup>th</sup> digits will show the whole numbers of the power rating itself. Example: 20 = 20W; 75 = 75W. 当功率在 20 瓦 ~ 99 瓦之间第 5 位至第 6 位全部表示功率。例: 20 = 20W; 75 = 75W.
  - e) For power rating of 100W & over, the 5<sup>th</sup> & 6<sup>th</sup> digits will be indicated with "00" and the actual wattage being indicated at the last 3 digits (12<sup>th</sup>~14<sup>th</sup>) of the Part No. 当大于 100 瓦时第 5 位和第 6 位表示为 "00" 实际功率表示在料号最后 3 位 (12 位 ~ 14 位)
  - f) For special power ratings, the following codes are to be used (特殊功率用下列数字表示):
    - 1). WH = 1/32W (10P8 Chip Network 网络电阻)
    - 2). 07 = 3/4WS [Chip 2010 size (晶片 2010 尺寸)]
    - 3). 04 = 0.4W-SS (0.4 watt Ultra Small size 超小尺寸)
    - 4). 06 = 0.6W-S (0.6 watt Small size 小尺寸)
    - 5). 2A = 2.5W
    - 6). 6A = 6.5W
  - g) For Resistor Network, since the power rating is fixed as 1/8W for A circuit & 1/5W for B circuit, the 5<sup>th</sup> & 6<sup>th</sup> digit is to be used to denote the number of pins required. Example: 09 = 9pins; 12 = 12pins. (网络电阻功率固定为 1/8W 或 1/5W, 故第 5 位和第 6 位用来表示所需要的 pins 数. 例: 09 = 9pins; 12 = 12pins.)
  - h) For Jumper Wires the 5<sup>th</sup> & 6<sup>th</sup> digits will be indicated with "00". (跳线电阻的第 5 位、第 6 位用 "00" 来表示)
  - i) For Thin Film Chip Resistors, these 2 digits will be used to indicate the requested Temperature coefficient:  
对于薄膜晶片电阻产品, 这两位用来表示产品的温度系数要求:
    - 1). 05 = 5PPM
    - 2). 10 = 10PPM
    - 3). 15 = 15PPM
    - 4). 25 = 25PPM
    - 5). 50 = 50PPM
3. The 7<sup>th</sup> digit is to denote the Resistance Tolerance. The following letter code is to be used for indicating the standard Resistance Tolerance. As for Metal Film Fixed Resistor products, it is also to denote the standard PPM as follows (第 7 位表示阻值误差。下列数码用来表示标准误差, 用于金属膜产品时, 同时用来表示标准 PPM, 如下):
 

B = ±0.1% (15PPM)	G = ±2% (100PPM)
C = ±0.25% (25PPM)	J = ±5% (200PPM)
D = ±0.5% (50PPM)	K = ±10%
F = ±1% (50PPM)	

Remark: if it not one of the above standard "tolerance-TCR", the requirement should be clearly stated when placing order.  
Example: ±1% (25PPM), the 7<sup>th</sup> digit still shows "F" but separately note the requirement of "25PPM"

注: 如果一个不是上述标准 "公差-PPM" 的要表示清楚  
例: ±1% (25PPM), 第 7 位要标示 "F" 并另注 "25PPM"

4. The 8<sup>th</sup> to 11<sup>th</sup> digits is to denote the Resistance Value (第8位~第11位表示阻值):

- a) For the standard resistance values of E-24 series in 5% & 10% tolerance, the 8<sup>th</sup> digit is "0", the 9<sup>th</sup> & 11<sup>th</sup> digits are to denote the significant figures of the resistance and the 11<sup>th</sup> digit is the number of zeros following (对于E-24系列的5%、10%产品,第8位数是0,第9位数和第10位数表示阻值的有效数,第11位表示有几个0。)
- b) For the standard resistance values of E-96 series in  $\leq 2\%$  tolerance, the 8<sup>th</sup> digit to the 10<sup>th</sup> digits are to denote the significant figures of the resistance and the 11<sup>th</sup> digit is the number of zeros following (对于E-96系列 $\leq 2\%$ 的产品,第8位数到第10位数表示阻值的有效数,第11位数表示有几个0。)
- c) For the code to the significant figures to E-24 & E-96 series, please refer to page 119 & 120 of the standards Resistance Value list.(有效数E-24和E-96系列,请参考119页和120页标准阻值表)
- d) The following numbers and the letter codes is to be used to indicate the number of zeros in the 11<sup>th</sup> digit:

以下数字及字母用来表示第11位数有几个0:

0 = 10 <sup>0</sup>	1 = 10 <sup>1</sup>	2 = 10 <sup>2</sup>	3 = 10 <sup>3</sup>	4 = 10 <sup>4</sup>	5 = 10 <sup>5</sup>
6 = 10 <sup>6</sup>	J = 10 <sup>-1</sup>	K = 10 <sup>-2</sup>	L = 10 <sup>-3</sup>	M = 10 <sup>-4</sup>	N = 10 <sup>-5</sup>

- e) For Cement Resistors the 8<sup>th</sup> digit will be coded with "W" or "P" to denote Wire-wound type or Power Film type respectively of the Cement Fixed Resistor product. The 9<sup>th</sup> to 11<sup>th</sup> please refer to point 4.a (水泥电阻第8位数"W"或"P"用来表示绕线型或切割型,第9位数到第11位数请参考4.a)

Example (例):

<u>E-24 series</u> 系列	<u>E-96 series</u> 系列	<u>Cement Resistors</u> 水泥型固定电阻值
0120 = 12 ohm	1210 = 121 ohm	W120 = 12 ohm Wire-wound type 绕线型
0123 = 12K ohm	1302 = 13K ohm	W12J = 1.2 ohm Wire-wound type 绕线型
012J = 1.2 ohm	196J = 19.6 ohm	P273 = 27 kohm Powe Film type 切割型

5. The 12<sup>th</sup>, 13<sup>th</sup> & 14<sup>th</sup> digits (第12位数、13位数和14位数):

- a) The 12<sup>th</sup> digit is to denote the Packaging type with the following codes (第12位数表示包装方式,采用如下代码):
- |  |  |
|--|--|
| A = Tape / Box (Ammo Pack) [编带/盒装(带装)] | C = Bulk in Cassette (for Chip product)[散装盒(晶片产品)] |
| B = Bulk / Box (散装/盒装)                 | T = Tape / Reel (编带/卷装)                            |
|  | P = Tape / Box of PT-26 product [编带/盒装(PT-26产品)]   |
- b) The 13<sup>th</sup> digit is normally to indicate the Packing Quantity of Tape/Box or Tape/Reel packaging types. Except for Chip products Bulk packing, this digit should be filled "0" or other products with "Bulk/Box packaging requirement. The following letter codes is to be used for some packaging quantities (第13位数一般表示包装数量对于T/B或T/R型,除了晶片散装外,其他产品的散装包装用"0"表示数量。下列字母说明包装数量。)
- |                   |                   |                   |                   |
|-------------------|-------------------|-------------------|-------------------|
| A = 500pcs (只)    | B = 2,500pcs (只)  | C = 10,000pcs (只) | E = 15,000pcs (只) |
| D = 20,000pcs (只) | G = 25,000pcs (只) | H = 50,000pcs (只) |                   |

Example (例):

<u>CHIP product</u> (晶片产品)	<u>Other products</u> (其它产品)
TD = T/R-20,000	A5 = T/B-5,000
TE = T/R-15,000	TB = T/R-2,500
T4 = T/R-4,000	BO = B/B (可提供标准包装)

- c) For the Forming type products, the 13<sup>th</sup> & 14<sup>th</sup> digits are used to denote the forming types of the product with the following letter codes (对于成型产品第13位数和第14位数用来表示成型产品,如下字母表示):

MF = M type with Flattened lead wire (M型打扁加工)	FO = F type 型
MK = M type with Kinked lead wire (M型打弯加工)	F1 = F1 type 型
ML = M type with normal lead wire (M型加工)	F2 = F2 type 型
MC = M type with kinked lead wire (M型打弯加工)	F3 = F3 type 型

- d) For power rating over 100watt, the 12<sup>th</sup> to the 14<sup>th</sup> digits are to denote the actual wattage of the products (当功率超过100W时,它的第12位数到14位数用来表示产品的实际功率):

Example (例): 100 = 100watt (瓦)    150 = 150watt (瓦)    225 = 225watt (瓦)

- e) For some products, the 14<sup>th</sup> digit alone can use to denote special features or additional information with the following codes

(对于某些产品第14位可以显示特性和附加信息,如下字母):

P = Panasert type (Panasert 型)	1 = Avisert 1 type (Avisert 1 型)	2 = Avisert 2 type (Avisert 2 型)
3 = Avisert 3 type (Avisert 3 型)	A = CO 1/4W - A type (切割型 CO 1/4W-A 型)	B = CO 1/4W - B type (切割型 CO 1/4W-B 型)
E = used to denote the "Environment Protection, lead Free type" of SMD category resistors (now, this became the Standard type of SMD) (晶片电阻,晶片排阻及网络电阻器“环保无铅型”)		

标准色码系统

4 Band Color Code (available for CFR, MOR, KNP & 2% or 5% of MFR products)

4 道色码 (适用于 CFR, MOR, KNP & 2% 或 5% of MFR 产品)

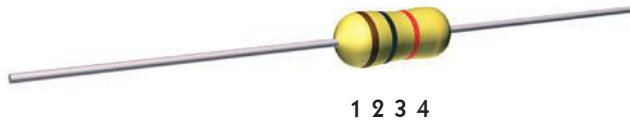

4th Band  
第四道

Red 红	= ±2%
Gold 金	= ±5%
Silver 银	= ±10%

1st Band  
第一道

Black 黑	= 0
Brown 棕	= 1
Red 红	= 2
Orange 橙	= 3
Yellow 黄	= 4
Green 绿	= 5
Blue 蓝	= 6
Violet 紫	= 7
Gray 灰	= 8
White 白	= 9

2nd Band  
第二道

Black 黑	= 0
Brown 棕	= 1
Red 红	= 2
Orange 橙	= 3
Yellow 黄	= 4
Green 绿	= 5
Blue 蓝	= 6
Violet 紫	= 7
Gray 灰	= 8
White 白	= 9

3rd Band  
第三道

Black 黑	= Multiply by 乘积倍数 1 ( $10^0$ )
Brown 棕	= Multiply by 乘积倍数 10 ( $10^1$ )
Red 红	= Multiply by 乘积倍数 100 ( $10^2$ )
Orange 橙	= Multiply by 乘积倍数 1,000 ( $10^3$ )
Yellow 黄	= Multiply by 乘积倍数 10,000 ( $10^4$ )
Green 绿	= Multiply by 乘积倍数 100,000 ( $10^5$ )
Blue 蓝	= Multiply by 乘积倍数 1,000,000 ( $10^6$ )
Violet 紫	= Multiply by 乘积倍数 10,000,000 ( $10^7$ )
Gold 金	= Multiply by 乘积倍数 0.1 ( $10^{-1}$ )
Silver 银	= Multiply by 乘积倍数 0.01 ( $10^{-2}$ )

5 Band Color Code (available for MFR 1% & FRN Products)

5 道色码 (适用于 MFR 1% & FRN 产品)



5th Band  
第五道

Violet 紫	= ±0.1%
Blue 蓝	= ±0.25%
Green 绿	= ±0.5%
Brown 棕	= ±1%

1st Band  
第一道

Black 黑	= 0
Brown 棕	= 1
Red 红	= 2
Orange 橙	= 3
Yellow 黄	= 4
Green 绿	= 5
Blue 蓝	= 6
Violet 紫	= 7
Gray 灰	= 8
White 白	= 9

2nd Band  
第二道

Black 黑	= 0
Brown 棕	= 1
Red 红	= 2
Orange 橙	= 3
Yellow 黄	= 4
Green 绿	= 5
Blue 蓝	= 6
Violet 紫	= 7
Gray 灰	= 8
White 白	= 9

3rd Band  
第三道

Black 黑	= 0
Brown 棕	= 1
Red 红	= 2
Orange 橙	= 3
Yellow 黄	= 4
Green 绿	= 5
Blue 蓝	= 6
Violet 紫	= 7
Gray 灰	= 8
White 白	= 9

4th Band  
第四道

Black 黑	= Multiply by 乘积倍数 1 ( $10^0$ )
Brown 棕	= Multiply by 乘积倍数 10 ( $10^1$ )
Red 红	= Multiply by 乘积倍数 100 ( $10^2$ )
Orange 橙	= Multiply by 乘积倍数 1,000 ( $10^3$ )
Yellow 黄	= Multiply by 乘积倍数 10,000 ( $10^4$ )
Green 绿	= Multiply by 乘积倍数 100,000 ( $10^5$ )
Blue 蓝	= Multiply by 乘积倍数 1,000,000 ( $10^6$ )
Violet 紫	= Multiply by 乘积倍数 10,000,000 ( $10^7$ )
Gold 金	= Multiply by 乘积倍数 0.1 ( $10^{-1}$ )
Silver 银	= Multiply by 乘积倍数 0.01 ( $10^{-2}$ )

A series of horizontal dashed lines for writing, spanning the width of the page.





**Uniroyal Electronics Industry Co., Ltd.**

**厚声电子工业有限公司**

21 Xiajia North Road, Economic & Technical Development Zone,  
Kunshan City, Jiangsu, CHINA 215334

中国江苏省昆山市经济技术开发区夏驾北路 21 号  
邮编：215334

Tel: +86 512 5763 1400 / 1411 / 1422 / 1433

fax: +86 512 5763 4599

localsales@uniohm.com

globalsales@uniohm.com

[www.uniohm.com](http://www.uniohm.com)



## X-ON Electronics

Largest Supplier of Electrical and Electronic Components

*Click to view similar products for [Thick Film Resistors - SMD category](#):*

*Click to view products by [Uniroyal manufacturer](#):*

Other Similar products are found below :

[CRCW04028R20JNEE](#) [CRCW06036K80FKEE](#) [CRG1206F1K58](#) [CRL0603-FW-R700ELF](#) [M55342K06B6E19RWL](#) [RC1005F1072CS](#)  
[RC1005F471CS](#) [RC1005F4751CS](#) [RCP0603W100RGED](#) [RCWP72251K47FKWB](#) [RLR05C7501GPB14](#) [RLR07C5111FSBSL](#) [ERJ-](#)  
[1GMF1R00C](#) [ERJ-1GMF1R20C](#) [ERJ-1GMF2R55C](#) [ERJ-1GMF8R66C](#) [25121WF1003T4E](#) [25.501.3653.0](#) [290-1.0M-RC](#) [292-1.0M-RC](#) [292-](#)  
[2.2K-RC](#) [292-4.7K-RC](#) [25121WF4700T4E](#) [292-470K-RC](#) [302-1.0M-RC](#) [CPG1206F10KC](#) [CRCW02011R00FXED](#) [CRCW060315K0FKEE](#)  
[CRCW060320K5FKEE](#) [CRG0201F10K](#) [RCG0402150RFKED](#) [RCG04023K92FKED](#) [RCP2512B100RGWB](#) [RCWP110010R0FKS3](#)  
[RCWP11002K00FKS3](#) [RCWP12061K00FKS2](#) [3520510RJT](#) [352075KJT](#) [M55342K11B9E53RUL](#) [RMC16-102JT](#) [RMC1JPTE](#) [TR0603MR-](#)  
[075K1L](#) [5-2176094-4](#) [35202K7JT](#) [WF06Q1000FTL](#) [ERJ-S03J1R0V](#) [ERJ-S14J4R7U](#) [CHP2512L4R30GNT](#) [CPCC10270R0JE32](#)  
[RCWP11001K00FKS3](#)