



**UNI-ROYAL**  
厚聲集團

# DATA SHEET

**Product Name** Thick Film Chip Resistors

**Part Name** 01005/0201/0402/0603/0805/1206/1210/1812/2010/2512 Series

## Uniroyal Electronics Global Co., Ltd.

88 Longteng Road, Economic & Technical Development Zone, Kunshan, Jiangsu, China

Tel +86 512 5763 1411 / 22 /33

Email [marketing@uni-royal.cn](mailto:marketing@uni-royal.cn)

Manufacture Plant Uniroyal Electronics Industry (kunshan) co., ltd.  
Uniroyal Electronics Industry Co., Ltd.  
Uniroyal Electronics Global Co.,Ltd Shenzhen Branch  
Aeon Technology Corporation  
Uniroyal Electronics Global Co.,Ltd Xiamen Branch  
Kunshan Foss Electronic material Co., Ltd.  
Royal Electronic Factory (thailand) co., ltd

Brands *RoyalOhm* *UniOhm*



## 1. Scope

- 1.1 This specification for approve relates to the Thick Film Chip Resistors manufactured by UNI-ROYAL.
- 1.2 Small size & light weight.
- 1.3 Reduction of assembly costs and matching with placement machine.
- 1.4 Suitable for both wave & re-flow soldering.
- 1.5 Applications: Navigator (GPS), Mobile Phone, Telecom, PDA, Setbox, Meter.

## 2. Explanation of Part No. System

Part No. includes 14 codes shown as below:

2.1 1<sup>st</sup>~4<sup>th</sup> codes: Part name. E.g.: 01005, 0201, 0402, 0603, 0805, 1206, 1210, 2010, 1812, 2512.

2.2 5<sup>th</sup>~6<sup>th</sup> codes: Power rating.

E.g.: W=Normal Size		“1~G” = “1~16”								
Wattage	1/32	3/4	1/2	1/3	1/4	1/8	1/10	1/16	1/20	1
Normal Size	WH	07	W2	W3	W4	W8	WA	WG	WM	1W

If power rating is lower or equal than 1 watt, 5<sup>th</sup> code would be “W” and 6<sup>th</sup> code would be a number or letter.

E.g.: WA=1/10W                      W4=1/4W

2.3 7<sup>th</sup> code: Tolerance. E.g.: D=±0.5%    F=±1%            G=±2%            J=±5%

2.4 8<sup>th</sup>~11<sup>th</sup> codes: Resistance Value.

2.4.1 If value belongs to standard value of ≥5% series, 8<sup>th</sup> code would be zero, 9<sup>th</sup>~10<sup>th</sup> codes are significant figures of the resistance and 11<sup>th</sup> code is the power of ten.

2.4.2 If value belongs to standard value of ≤2% series, 8<sup>th</sup>~10<sup>th</sup> codes are significant figures of the resistance, and 11<sup>th</sup> code is the power of ten.

2.4.3 11<sup>th</sup> codes listed as following:

0=10<sup>0</sup>    1=10<sup>1</sup>    2=10<sup>2</sup>    3=10<sup>3</sup>    4=10<sup>4</sup>    5=10<sup>5</sup>    6=10<sup>6</sup>    J=10<sup>-1</sup>    K=10<sup>-2</sup>    L=10<sup>-3</sup>    M=10<sup>-4</sup>    N=10<sup>-5</sup>    P=10<sup>-6</sup>

2.5 12<sup>th</sup>~14<sup>th</sup> codes.

2.5.1 12<sup>th</sup> code: Packaging Type. E.g.: C=Bulk                      T=Tape/Reel

2.5.2 13<sup>th</sup> code: Standard Packing Quantity.

4=4000pcs    5=5000pcs            C=10000pcs    D=20000pcs            E=15000pcs

Chip Product: BD=B/B-20000pcs            TC=T/R-10000pcs

2.5.3 14<sup>th</sup> code: Special features.

E = Environmental Protection, Lead Free, or Standard type.

## 3. Ordering Procedure

(Example: 0805 1/8W ±5% 10KΩ T/R-5000)



## 4. Marking

(1) For 01005、0201 and 0402 size. Due to the very 01005、0201、0402 small size of the resistor's body, there is no marking on the body.



(2) Normally, the making of 0Ω 0603, 0Ω 0805, 0Ω 1206, 0Ω 1210, 0Ω 1812, 0Ω 2010, 0Ω 2512 resistors as following



0 → 0Ω

(3) ±2%,±5%Tolerance:The first two digits are significant figures of resistance and the third denotes number of zeros following



333 → 33KΩ

(4) ±0.5%、±1% Tolerance: 4 digits, first three digits are significant; fourth digit is number of zeros. Letter r is decimal point.



2701 → 2.7KΩ

(5) More than 0805 specifications (including) 4 digits, Product below 1Ω, show as following, the first digit Is “R” which as decimal point.



R300 → 0.3Ω

(6) Standard E-96 series values of 0603 ≤1% : due to the small size of the resistor's body, 3 digits marking will be used to indicate the accurate resistance value by using the following multiplier & resistance code.

Multiplier Code (for 0603 ≤±1% marking)

Code	A	B	C	D	E	F	G	H	X	Y	Z
Multiplier	10 <sup>0</sup>	10 <sup>1</sup>	10 <sup>2</sup>	10 <sup>3</sup>	10 <sup>4</sup>	10 <sup>5</sup>	10 <sup>6</sup>	10 <sup>7</sup>	10 <sup>-1</sup>	10 <sup>-2</sup>	10 <sup>-3</sup>

Standard E-96 series Resistance Value code (for 0603≤±1% marking)

Value	Code	Value	Code	Value	Code	Value	Code
100	01	178	25	316	49	562	73
102	02	182	26	324	50	576	74
105	03	187	27	332	51	590	75
107	04	191	28	340	52	604	76
110	05	196	29	348	53	619	77
113	06	200	30	357	54	634	78
115	07	205	31	365	55	649	79
118	08	210	32	374	56	665	80
121	09	215	33	383	57	681	81
124	10	221	34	392	58	698	82
127	11	226	35	402	59	715	83
130	12	232	36	412	60	732	84
133	13	237	37	422	61	750	85
137	14	243	38	432	62	768	86
140	15	249	39	442	63	787	87
143	16	255	40	453	64	806	88
147	17	261	41	464	65	825	89
150	18	267	42	475	66	845	90
154	19	274	43	487	67	866	91
158	20	280	44	499	68	887	92
162	21	287	45	511	69	909	93
165	22	294	46	523	70	931	94
169	23	301	47	536	71	953	95
174	24	309	48	549	72	976	96

So the resistance value are marked as the following examples



$1.96K\Omega = 196 \times 10^1 \Omega = 29B$



$12.4\Omega = 124 \times 10^{-1} \Omega = 10X$

(7) Standard E-24 and not belong to E-96 series values ( $\leq \pm 1\%$ ) of 0603 size: the marking is the same as 5% tolerance but marking as underli



$333 = 33K\Omega$



$680 = 68\Omega$

**5. Dimension**

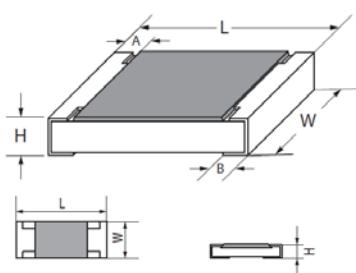

Type	Dimension(mm)				
	L	W	H	A	B
01005	0.40±0.02	0.20±0.02	0.13±0.02	0.10±0.03	0.10±0.03
0201	0.60±0.03	0.30±0.03	0.23±0.03	0.10±0.05	0.15±0.05
0402	1.00±0.10	0.50±0.05	0.35±0.05	0.20±0.10	0.25±0.10
0603	1.60±0.10	0.80±0.10	0.45±0.10	0.30±0.20	0.30±0.20
0805	2.00±0.15	1.25+0.15/-0.10	0.55±0.10	0.40±0.20	0.40±0.20
1206	3.10±0.15	1.55 +0.15/-0.10	0.55±0.10	0.45±0.20	0.45±0.20
1210	3.10±0.10	2.60±0.20	0.55±0.10	0.50±0.25	0.50±0.20
1812	4.50±0.20	3.20±0.20	0.55±0.20	0.50±0.20	0.50±0.20
2010	5.00±0.10	2.50±0.20	0.55±0.10	0.60±0.25	0.50±0.20
2512	6.35±0.10	3.20±0.20	0.55±0.10	0.60±0.25	0.50±0.20

**6. Resistance Range**

Type	Power Rating at 70°C	Resistance Range			
		0.5%	1.0%	2.0%	5.0%
01005	1/32W	---	10Ω-10MΩ	10Ω-10MΩ	1Ω-10MΩ
0201	1/20W	---	1Ω-10MΩ	1Ω-10MΩ	1Ω-10MΩ
0402	1/16W	1Ω-10MΩ	1Ω-10MΩ	1Ω-10MΩ	1Ω-10MΩ
0603	1/10W	1Ω-10MΩ	0.01Ω-10MΩ	0.01Ω-10MΩ	0.01Ω-10MΩ
0805	1/8W	1Ω-10MΩ	0.1Ω≤R<10MΩ	0.1Ω≤R<10MΩ	0.1Ω≤R<10MΩ
	1/4W	---	0.01Ω≤R<0.1Ω	0.01Ω≤R<0.1Ω	0.01Ω≤R<0.1Ω
1206	1/4W	1Ω-10MΩ	0.1Ω≤R<10MΩ	0.1Ω≤R<10MΩ	0.1Ω≤R<10MΩ
	1/3W	---	0.01Ω≤R<0.1Ω	0.01Ω≤R<0.1Ω	0.01Ω≤R<0.1Ω
1210	1/2W	1Ω-10MΩ	0.01Ω-10MΩ	0.01Ω-10MΩ	0.01Ω-10MΩ
1812	3/4W	1Ω-10MΩ	0.01Ω-10MΩ	0.01Ω-10MΩ	0.01Ω-10MΩ
2010	3/4W	1Ω-10MΩ	0.01Ω-10MΩ	0.01Ω-10MΩ	0.01Ω-10MΩ
2512	1W	1Ω-10MΩ	0.01Ω-10MΩ	0.01Ω-10MΩ	0.01Ω-10MΩ

## 7. Ratings

Type	Max. Working Voltage	Max. Overload Voltage	Dielectric withstanding Voltage	Resistance Value of Jumper	Rated Current of Jumper	Max. Overload Current of Jumper	Operating Temperature
01005	15V	30V	--	<50mΩ	0.5A	1A	-55°C~125°C
0201	25V	50V	--	<50mΩ	0.5A	1A	-55°C~155°C
0402	50V	100V	100V	<50mΩ	1A	2A	-55°C~155°C
0603	75V	150V	300V	<50mΩ	1A	2A	-55°C~155°C
0805	150V	300V	500V	<50mΩ	2A	5A	-55°C~155°C
1206	200V	400V	500V	<50mΩ	2A	10A	-55°C~155°C
1210	200V	500V	500V	<50mΩ	2A	10A	-55°C~155°C
1812	200V	500V	500V	<50mΩ	2A	10A	-55°C~155°C
2010	200V	500V	500V	<50mΩ	2A	10A	-55°C~155°C
2512	200V	500V	500V	<50mΩ	2A	10A	-55°C~155°C

## 8. Recommend the size of welding plate



Type	Dimension(mm)			
	A	B	C	D
01005	0.14±0.03	0.2±0.03	0.2±0.03	0.54±0.03
0201	0.25±0.05	0.35±0.05	0.4±0.05	1.0±0.05
0402	0.50±0.05	0.45±0.05	0.5±0.05	1.4±0.05
0603	0.9±0.05	0.65±0.05	0.8±0.05	2.1±0.05
0805	1.0±0.1	1.0±0.1	1.3±0.1	3.0±0.1
1206	2.0±0.1	1.1±0.1	1.6±0.1	4.2±0.1
1210	2.0±0.1	1.1±0.1	2.6±0.1	4.2±0.1
1812	3.2±0.1	1.4±0.1	3.3±0.1	5.8±0.1
2010	3.6±0.1	1.3±0.1	2.6±0.1	6.2±0.1
2512	5.0±0.1	1.6±0.1	3.3±0.1	8.2±0.1

## 9. Derating Curve

Resistors shall have a power rating based on continuous load operation at an ambient temperature from -55°C to 70°C. For temperature in excess of 70°C, the load shall be derated as shown in figure 1

Figure 1

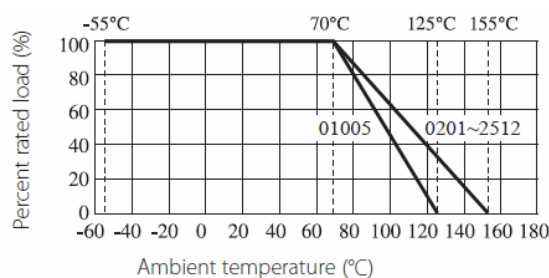

Voltage rating:

Resistors shall have a rated direct-current (DC) continuous working

voltage or an approximate sine-wave root-mean-square (RMS) alternating-current (AC) continuous working voltage at commercial-line frequency and waveform corresponding to the power rating, as determined from the following formula:

$$RCWV = \sqrt{P \times R}$$

Where: RCWV commercial-line frequency and waveform (Volt.)

P = power rating (WATT.) R = nominal resistance (OHM)

In no case shall the rated DC or RMS AC continuous working voltage be greater than the applicable maximum value.

The overload voltage is 2.5 times RCWV or Max. Overload voltage whichever is less

## 10. Structure

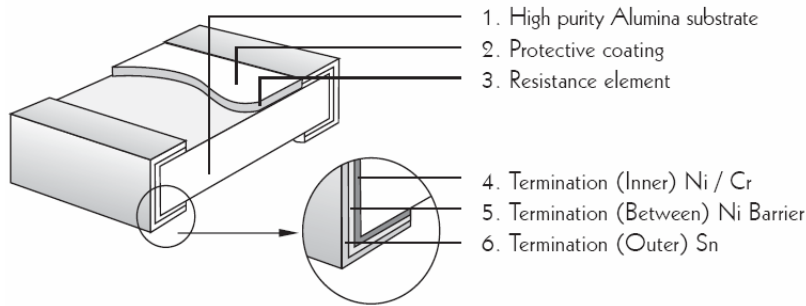

## 11. Performance Specification

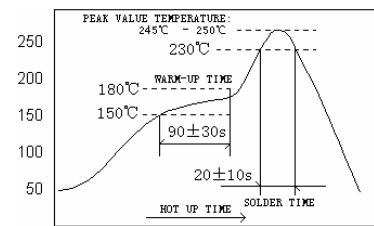
Characteristic	Limits	Test Method (GB/T 5729&JIS-C-5201&IEC60115-1)
◎ Temperature Coefficient	01005: $1\Omega \leq R < 10\Omega$ : -200~+600PPM/°C $10\Omega \leq R < 100\Omega$ : ±300PPM/°C $100\Omega \leq R \leq 10M\Omega$ : ±200PPM/°C 0201: $1\Omega \leq R \leq 10\Omega$ : -100~ + 350PPM/°C >10Ω: ±200PPM/°C 0402: $1\Omega \leq R \leq 10\Omega$ : ±200PPM/°C >10Ω: ±100PPM/°C 0603: $0.01\Omega \leq R \leq 0.03\Omega$ : ±1500 PPM/°C $0.03\Omega < R \leq 0.05\Omega$ : ±1000 PPM/°C $0.05\Omega < R < 1\Omega$ : ±800PPM/°C $1\Omega \leq R \leq 10\Omega$ : ±200PPM/°C >10Ω: ±100PPM/°C 0805,1206,1210,2010,1812,2512: $0.01\Omega \leq R \leq 0.015\Omega$ : ±1500PPM/°C $0.015\Omega < R \leq 0.03\Omega$ : ±1000PPM/°C $0.03\Omega < R < 1\Omega$ : ±800PPM/°C $1\Omega \leq R \leq 10\Omega$ : ±200PPM/°C >10Ω: ±100PPM/°C	4.8 Natural resistance changes per temp. Degree centigrade $\frac{R_2 - R_1}{R_1(t_2 - t_1)} \times 10^6 \text{ (PPM/°C)}$ R <sub>1</sub> : Resistance Value at room temperature (t <sub>1</sub> ) ; R <sub>2</sub> : Resistance at test temperature (Upper limit temperature or Lower limit temperature) t <sub>1</sub> : +25°C or specified room temperature t <sub>2</sub> : Upper limit temperature or Lower limit temperature test temperature
◎ *Short-time overload	$\pm 0.5\%, \pm 1\%$ : ±(1.0%+0.05Ω) $\pm 2\%, \pm 5\%$ : ±(2.0%+0.05Ω) 01005: ±(2.0%+0.05Ω) * <50mΩ	4.13 Permanent resistance change after the application of a potential of 2.5 times RCWV or Max. Overload Voltage whichever less for 5 seconds.. Apply max Overload current for 0Ω
* Dielectric withstanding voltage	No evidence of flashover mechanical damage, arcing or insulation breaks down.	4.7 Resistors shall be clamped in the trough of a 90°C metallic v-block and shall be tested at ac potential respectively specified in the given list of each product type for 60-70 seconds.
◎ *Solderability	Coverage must be over 95%. Go up tin rate bigger than half of end pole	Wave solder: Test temperature of solder: 245°C±3°C dipping time in solder: 2-3 seconds. Reflow: 

◎ Rapid change of temperature	±0.5%,±1%:     ±(0.5%+0.05Ω)	4.19 30 min at -55 °C and 30 min at 155°C; 100 cycles.
	±2%,±5% :       ±(1.0%+0.05Ω)	
	01005:           ±(1.0%+0.05Ω)	
◎ Soldering heat	±(1.0%+0.05Ω)	4.18 Dip the resistor into a solder bath having a temperature of 260°C±5°C and hold it for 10±1 seconds.
Terminal bending	±(1.0%+0.05Ω)	4.33 Twist of test board: Y/X = 3/90 mm for 60Seconds
* Insulation resistance	≥1,000 MΩ	4.6 The measuring voltage shall be ,measured with a direct voltage of (100±15)V or a voltage equal to the dielectric withstanding voltage., and apply for 1min.
◎ Humidity ( steady state )	±0.5%,±1%:     ±(0.5%+0.05Ω)	4.24 Temporary resistance change after 240 hours exposure in a humidity test chamber controlled at 40±2°C and 90-95% relative humidity,
	±2%,±5% :       ±(3.0%+0.05Ω)	
	01005(-55°C~125°C): ±(2.0%+0.05Ω)	
◎ *Load life in humidity	±0.5%,±1% :     ±(1.0%+0.05Ω)	7.9 Resistance change after 1,000 hours (1.5 hours “ON”,0.5 hour “OFF”) at RCWV in a humidity chamber controlled at 40°C±2°C and 90 to 95% relative humidity.
	±2%,±5% :       ±(3.0%+0.05Ω)	
	01005:           ±(3.0%+0.05Ω)	
	* <50mΩ	Apply to rated current for 0Ω
◎ *Load life	±0.5%,±1%:     ±(1.0%+0.05Ω)	4.25.1 Permanent resistance change after 1,000 hours operating at RCWV with duty cycle 1.5 hours “ON”, 0.5 hour “OFF” at 70°C±2°C ambient.
	±2%,±5% :       ±(3.0%+0.05Ω)	
	01005:           ±(3.0%+0.05Ω)	
	* <50MΩ	Apply to rated current for 0Ω
◎ *Low Temperature Storage	±0.5%,±1% :     ±(1.0%+0.05Ω)	4.23.4 Lower limit temperature , for 2H.
	±2%,±5% :       ±(3.0%+0.05Ω)	
	* <50mΩ	
		Apply to rated current for 0Ω
◎ *High Temperature Exposure	±0.5%,±1%:     ±(1.0%+0.05Ω)	4.23.2 Upper limit temperature , for 16H.
	±2%,±5% :       ±(3.0%+0.05Ω)	
	01005:           ±(1.0%+0.05Ω)	
	* <50mΩ	4.23.2 Upper limit temperature , for 1000H.
		Apply to rated current for 0Ω
◎ *Leaching	No visible damage	J-STD-002 Test D Samples completely immersed for 30 sec in solder bath at 260°C.

The resistors of 0Ω only can do the characteristic noted of \*

The resistors of 01005 & 0201 only can do the characteristic noted of ◎

## 12. Packing of Surface Mount Resistors

### 12.1 Dimension of Paper Taping :(Unit: mm)

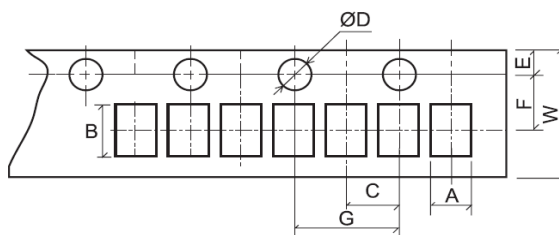

Type	A	B	C ±0.05	<sup>+0.1</sup> ΦD <sub>-0</sub>	E ±0.1	F ±0.05	G ±0.1	W ±0.2	T
01005	0.24±0.05	0.45±0.05	2.00	1.50	1.75	3.50	4.00	8.00	0.40±0.1
0201	0.40±0.05	0.70±0.05	2.00	1.50	1.75	3.50	4.00	8.00	0.42±0.1
0402	0.65±0.10	1.20±0.10	2.00	1.50	1.75	3.50	4.00	8.00	0.42±0.05

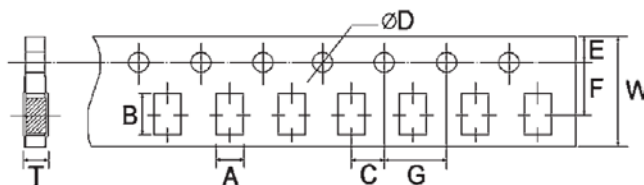

Type	A ±0.2	B ±0.2	C ±0.05	+0.1 ØD -0	E ±0.1	F ±0.05	G ±0.1	W ±0.2	T ±0.1
0603	1.10	1.90	2.00	1.50	1.75	3.50	4.00	8.00	0.67
0805	1.65	2.40	2.00	1.50	1.75	3.50	4.00	8.00	0.81
1206	2.00	3.60	2.00	1.50	1.75	3.50	4.00	8.00	0.81
1210	2.80	3.50	2.00	1.50	1.75	3.50	4.00	8.00	0.75

12.2 Dimension of Embossed Taping: (Unit: mm)

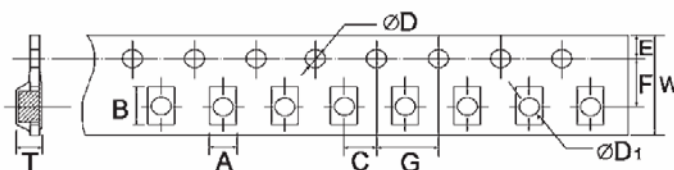

Type	A ±0.2	B ±0.2	C ±0.05	+0.1 φD -0	+0.25 φD1 -0	E ±0.1	F ±0.05	G ±0.1	W ±0.2	T ±0.1
2010	2.90	5.60	2.00	1.50	1.50	1.75	5.50	4.00	12.00	1.00
1812	3.50	4.80	2.00	1.50	1.50	1.75	5.50	4.00	12.00	1.00
2512	3.50	6.70	2.00	1.50	1.50	1.75	5.50	4.00	12.00	1.00

12.3 Dimension of Reel : (Unit: mm)



Type	Taping	Qty/Reel	A ±0.5	B ±0.5	C ±0.5	D ±1	M ±2	W ±1
01005	Paper	20,000pcs	2.0	13.0	21.0	60.0	178.0	10.0
0201	Paper	15,000pcs	2.0	13.0	21.0	60.0	178.0	10.0
0402	Paper	10,000pcs	2.0	13.0	21.0	60.0	178.0	10.0
0603	Paper	5,000pcs	2.0	13.0	21.0	60.0	178.0	10.0
0805	Paper	5,000pcs	2.0	13.0	21.0	60.0	178.0	10.0
1206	Paper	5,000pcs	2.0	13.0	21.0	60.0	178.0	10.0
1210	Paper	5,000pcs	2.0	13.0	21.0	60.0	178.0	10.0
2010	Embossed	4,000pcs	2.0	13.0	21.0	60.0	178.0	13.8
1812	Embossed	4,000pcs	2.0	13.0	21.0	60.0	178.0	13.8
2512	Embossed	4,000pcs	2.0	13.0	21.0	60.0	178.0	13.8



### 13. Note

- 13.1. UNI-ROYAL recommend the storage condition temperature: 15°C~35°C, humidity :25%~75%.  
 (Put condition for individual product).Even under UNI-ROYAL recommended storage condition, solderability of products over 1 year old.  
 (Put condition for each product) may be degraded.
- 13.2. Store / transport cartons in the correct direction, which is indicated on a carton as a symbol.  
 Otherwise bent leads may occur due to excessive stress applied when dropping of a carton.
- 13.3. Product performance and soldered connections may deteriorate if the products are stored in the following places:
- Storage in high Electrostatic.
  - Storage in direct sunshine 、rain and snow or condensation.
  - Where the products are exposed to sea winds or corrosive gases, including Cl<sub>2</sub>, H<sub>2</sub>S, NH<sub>3</sub>, SO<sub>2</sub>, NO<sub>2</sub>.
- 13.4. The products are used in circuit board thickness greater than 1.6mm. If customers use less than the thickness of the circuit board that you should confirm with the company, in order to recommend a more suitable product.

### 14. Record

Version	Description of amendment	Page	Date	Amended by	Checked by
1	First issue of this specification	1~7	Mar.20, 2018	Chen Haiyan	Chen Nana
2	Modify 0201 packing quantity	7	May.24, 2018	Chen Haiyan	Chen Nana
3	1. Add 0603 code mark	3~4	Feb.12, 2019	Chen Haiyan	Xu Yuhua
	2. Modify the operating temperature of 01005	5			
	3. Modify the Performance Specification	6~7			

Uniroyal Electronics Global Co., Ltd. , all rights reserved. Spec. herein would be changed at any time without prior notice.

## X-ON Electronics

Largest Supplier of Electrical and Electronic Components

*Click to view similar products for [Thick Film Resistors](#) category:*

*Click to view products by [Uniroyal](#) manufacturer:*

Other Similar products are found below :

[MCR03EZPFX3162](#) [MCR004YZPJ332](#) [201007J022KT4E](#) [201007F1653T4E](#) [201007F6652T4E](#) [0603WAF137KT5E](#) [RTT204702FTE](#)  
[RTT203000FTE](#) [RTT2056R0FTE](#) [CR2010F470KE04Z](#) [RTT018451FTH](#) [RTT021802DTH](#) [0402WGF510LTCE](#) [0201WMJ0200TEE](#)  
[TR0603B26K7P0550Z](#) [0201WMF5102TEE](#) [1210W2J047KT5E](#) [YLR12-2-4F-W](#) [HOT\(0.25x1.3\)-3.2-0R-I](#) [HOT\(0.4x1.5\)-5.2-0R-I](#)  
[HoT\(0.45x1.5\)-8.2-0R-I](#) [0201WMF1103TEE](#) [0201WMF7152TEE](#) [1210W2J0124T5E](#) [201007J010LT4E](#) [201007J0360T4E](#) [201007J0430T4E](#)  
[0805W8F931KT5E](#) [1206W4F5231T5E](#) [1210W2J0620T5E](#) [201007J0822T4E](#) [0201WMF1005TCE](#) [0201WMF1212TCE](#) [0201WMF1373TCE](#)  
[0201WMF1400TCE](#) [0201WMF2000TEE](#) [0201WMF2001TCE](#) [0201WMF226JTCE](#) [0201WMF2672TCE](#) [0201WMF2803TCE](#)  
[0201WMF357JTCE](#) [0201WMF3743TCE](#) [0201WMF430JTCE](#) [0201WMF4990TCE](#) [0201WMF5104TCE](#) [0201WMF510JTEE](#)  
[0201WMF5110TCE](#) [0201WMF6652TEE](#) [0201WMF6812TCE](#) [0201WMF8200TCE](#)