



**UNI-ROYAL**  
厚聲集團

# DATA SHEET

**Product Name** Automotive Low Resistance Thick Film Chip Resistors

---

**Part Name** CS Series

## Uniroyal Electronics Global Co., Ltd.

88 Longteng Road, Economic & Technical Development Zone, Kunshan, Jiangsu, China

Tel +86 512 5763 1411 / 22 /33

Email [marketing@uni-royal.cn](mailto:marketing@uni-royal.cn)

Manufacture Plant Uniroyal Electronics Industry (kunshan) co., ltd.  
Uniroyal Electronics Industry Co., Ltd.  
Uniroyal Electronics Global Co.,Ltd Shenzhen Branch  
Aeon Technology Corporation  
Uniroyal Electronics Global Co.,Ltd Xiamen Branch  
Kunshan Foss Electronic material Co., Ltd.  
Royal Electronic Factory (thailand) co., ltd

Brands *RoyalOhm* *UniOhm*



### 1. Scope:

- 1.1 This specification for approve relates to the Automotive Low Resistance Thick Film Chip Resistors manufactured by UNI-ROYAL.
- 1.2 Ultra-low Value
- 1.3 Low Temperature Coefficient
- 1.4 Suitable for reflow & wave soldering
- 1.5 Application: Power supply
- 1.6 The test items follow the test standard of AEC-Q200.

### 2. Part No. System

Part No. includes 14 codes shown as below:

2.1 1st~4th codes: Part name. E.g.: CS02,CS03,CS05,CS06,CS07,CS10,CS11,CS12

2.2 5th~6th codes: Power rating.

E.g.: W=Normal Size                      "1~G" = "1~16"

Wattage	1/32	3/4	1/2	1/3	1/4	1/8	1/10	1/16	1/20	1
Normal Size	WH	07	W2	W3	W4	W8	WA	WG	WM	1W

If power rating is lower or equal than 1 watt, 5<sup>th</sup> code would be "W" and 6<sup>th</sup> code would be a number or letter.

E.g.: WA=1/10W                      W4=1/4W

2.3 7<sup>th</sup> code: Tolerance. E.g.: D=±0.5%                      F=±1%                      G=±2%                      J=±5%                      K= ±10%

2.4 8<sup>th</sup>~11<sup>th</sup> codes: Resistance Value.

2.4.1 If value belongs to standard value of ≥5% series, 8<sup>th</sup> code would be zero, 9<sup>th</sup>~10<sup>th</sup> codes are significant figures of the resistance and 11<sup>th</sup> code is the power of ten.

2.4.2 If value belongs to standard value of ≤2% series, 8<sup>th</sup>~10<sup>th</sup> codes are significant figures of the resistance, and 11<sup>th</sup> code is the power of ten.

2.4.3 11<sup>th</sup> codes listed as following:

0=10<sup>0</sup>                      1=10<sup>1</sup>                      2=10<sup>2</sup>                      3=10<sup>3</sup>                      4=10<sup>4</sup>                      5=10<sup>5</sup>                      6=10<sup>6</sup>                      J=10<sup>-1</sup>                      K=10<sup>-2</sup>                      L=10<sup>-3</sup>                      M=10<sup>-4</sup>

2.5 12<sup>th</sup>~14<sup>th</sup> codes.

2.5.1 12<sup>th</sup> code: Packaging Type. E.g.: C=Bulk                      T=Tape/Reel

2.5.2 13<sup>th</sup> code: Standard Packing Quantity.

4=4000pcs                      5=5000pcs                      C=10000pcs                      D=20000pcs                      E=15000pcs

Chip Product: BD=B/B-20000pcs                      TC=T/R-10000pcs

2.5.3 14<sup>th</sup> code: Special features.

E = Environmental Protection, Lead Free, or Standard type.

### 3. Ordering Procedure

(Example: CS12 1W ±1% 0.018Ω T/R-4000)

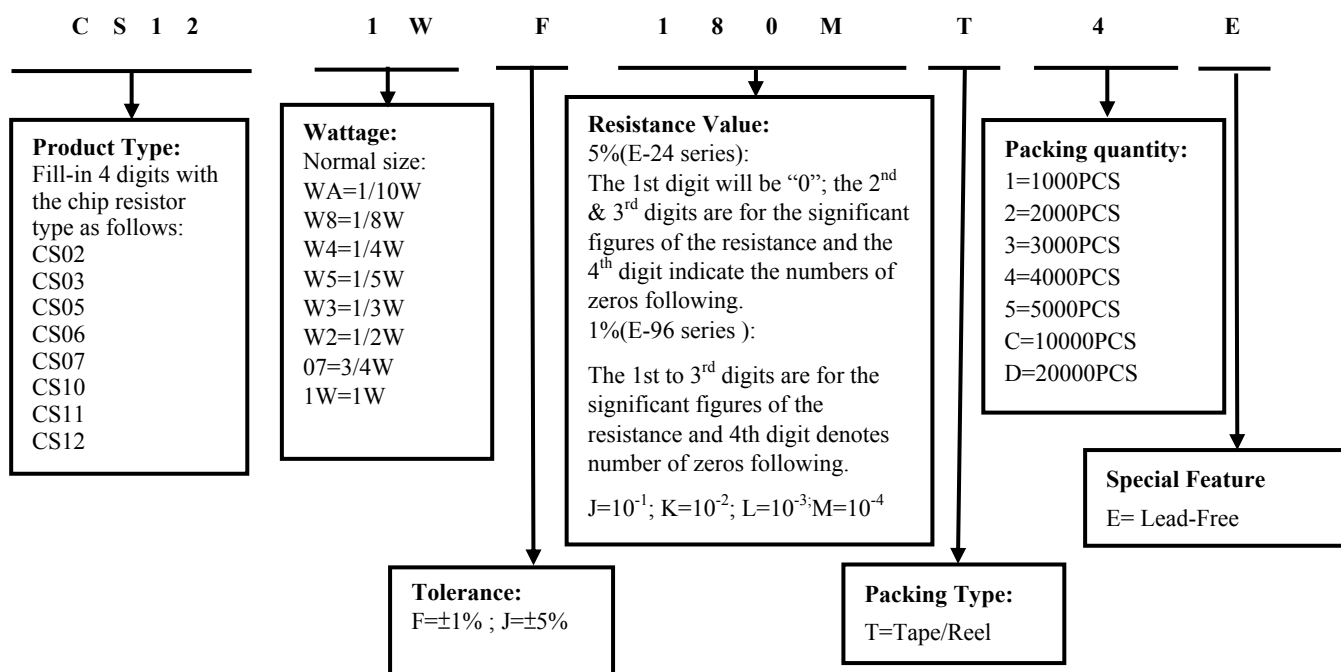

#### 4. Marking:

(1) For CS02 size. Due to the very CS02 small size of the resistor's body, there is no marking on the body.

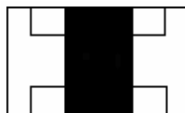

(2) For CS03 size: Below 100mΩ (do not contain) product 3 digits of ±1%, ±5% Tolerance, show as following:

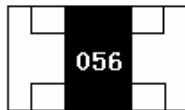

056 → 0.056 Ω

(3) For CS03 size: Above (contain) 100mΩ product: 3 digits, the first digit is "R", which as decimal point, the 2nd & 3rd digits are significant.

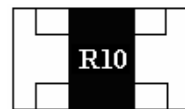

R10 → 100mΩ

(4) ±1%, ±5% Tolerance: product below 1Ω show as following, the first digit is "R", which as decimal point.

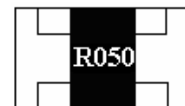

R050 → 50mΩ

(5) ±1%, ±5% Tolerance: product of 1Ω show as following, the first digit is "1", read alphabet "R" as decimal point.

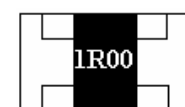

1R00 → 1 Ω

#### 5. Dimension

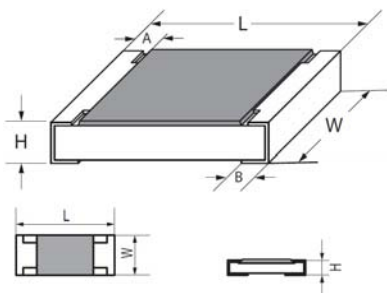

Type	Dimension(mm)				
	L	W	H	A	B
CS02(0402)	1.00±0.10	0.50±0.05	0.35±0.05	0.20±0.10	0.25±0.10
CS03(0603)	1.60±0.10	0.80±0.10	0.45±0.10	0.30±0.20	0.30±0.20
CS05(0805)	2.00±0.15	1.25+0.15/-0.10	0.55±0.10	0.40±0.20	0.40±0.20
CS06(1206)	3.10±0.15	1.55+0.15/-0.10	0.55±0.10	0.45±0.20	0.45±0.20
CS07(1210)	3.10±0.10	2.60±0.20	0.55±0.10	0.50±0.25	0.50±0.20
CS10(2010)	5.00±0.10	2.50±0.20	0.55±0.10	0.60±0.25	0.50±0.20
CS11(1812)	4.50±0.20	3.20±0.20	0.55±0.20	0.50±0.20	0.80±0.30
CS12(2512)	6.35±0.10	3.20±0.20	0.55±0.10	0.60±0.25	0.80±0.30

#### 6. Resistance Range

Type	Power Rating at 70°C	Dielectric withstanding Voltage	Resistance Range 1%&5%	Operating Temperature
CS02	1/8W	100V	50mΩ~1Ω	-55°C~155°C
CS03	1/5W	300V	10mΩ~1Ω	-55°C~155°C
CS05	1/4W	500V	10mΩ~1Ω	-55°C~155°C
CS06	1/3W	500V	10mΩ~1Ω	-55°C~155°C
CS07	1/2W	500V	10mΩ~1Ω	-55°C~155°C
CS10	3/4W	500V	10mΩ~1Ω	-55°C~155°C
CS11	3/4W	500V	10mΩ~1Ω	-55°C~155°C
CS12	1W	500V	10mΩ~1Ω	-55°C~155°C

## 7. Recommend the size of welding plate

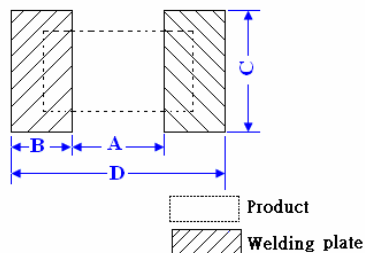

Type	Dimension(mm)			
	A	B	C	D
CS02	0.5±0.05	0.5±0.05	0.6±0.05	1.5±0.05
CS03	0.8±0.05	1±0.05	0.9±0.05	2.7±0.05
CS05	1.0±0.1	1±0.1	1.4±0.1	3.4±0.1
CS06	2.0±0.1	1.1±0.1	1.8±0.1	4.2±0.1
CS07	2.0±0.1	1.1±0.1	2.9±0.1	4.2±0.1
CS10	3.6±0.1	1.4±0.1	3±0.1	6.4±0.1
CS11	2.9±0.1	1.5±0.1	3.7±0.1	5.9±0.1
CS12	4.4±0.1	2.1±0.1	3.7±0.1	8.6±0.1

## 8. Derating Curve

Resistors shall have a power rating based on continuous load operation at an ambient temperature from -55°C to 70°C. For temperature in excess of 70°C, the load shall be derated as shown in figure 1

Figure 1

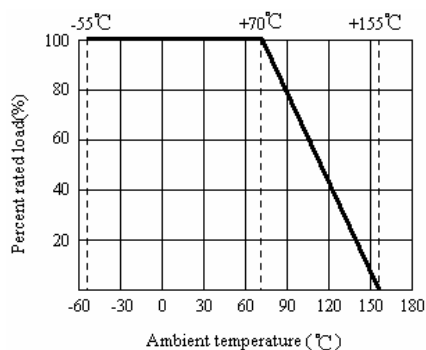

Voltage rating:

Resistors shall have a rated direct-current (DC) continuous working

voltage or an approximate sine-wave root-mean-square (RMS) alternating-current (AC) continuous working voltage at commercial-line frequency and waveform corresponding to the power rating, as determined from the following formula:

$$RCWV = \sqrt{P \times R}$$

Where: RCWV commercial-line frequency and waveform (Volt.)

P = power rating (WATT.) R = nominal resistance (OHM)

In no case shall the rated DC or RMS AC continuous working voltage be greater than the applicable maximum value.

The overload voltage is 2.5 times RCWV or Max. Overload voltage whichever is less

## 9. Structure

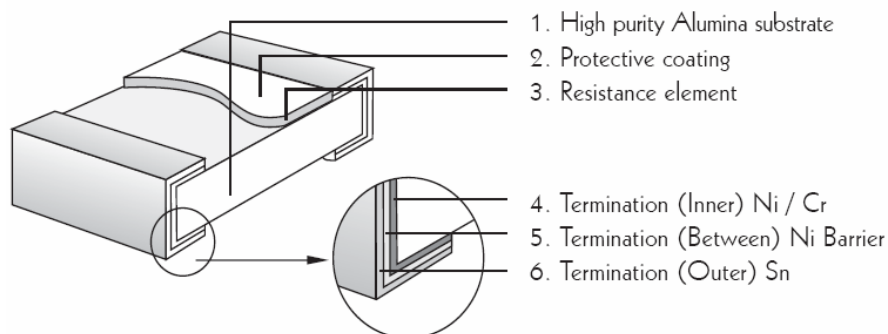

**10. Performance Specification**

Characteristic	Limits	Ref. Standards	Test Method
Operational life	±1%: ±(1.0%+0.005Ω) Max. ±5%: ±(3.0%+0.005Ω) Max.	MIL-STD-202 Method 108	125°C, at 36% of operating power, 1000H(1.5 hours "ON", 0.5 hour "OFF").
Electrical Characterization	CS02: 50mΩ≤R<100mΩ: ±700 ppm/°C 100mΩ≤R≤1Ω: ±200 ppm/°C CS03: 10mΩ≤R<15mΩ: ±1500 ppm/°C 15mΩ≤R<20mΩ: ±1000 ppm/°C 20mΩ≤R<30mΩ: ±800 ppm/°C 30mΩ≤R<33mΩ: ±600 ppm/°C 33mΩ≤R≤50mΩ: ±400 ppm/°C 50mΩ<R≤0.1Ω: ±300 ppm/°C 0.1Ω<R≤1Ω: ±200 ppm/°C CS05: 10mΩ≤R≤15mΩ: ±800 ppm/°C 15mΩ<R≤25mΩ: ±600 ppm/°C 25mΩ<R≤50mΩ: ±400 ppm/°C 50mΩ<R≤0.2Ω: ±200 ppm/°C 0.2Ω<R≤1Ω: ±100 ppm/°C CS06: 10mΩ≤R < 15mΩ: ±700ppm/°C 15mΩ≤R≤30mΩ: ±400ppm/°C 30mΩ < R≤50mΩ: ±300ppm/°C 50mΩ < R≤0.1Ω: ±200ppm/°C 0.1Ω < R≤1Ω: ±150ppm/°C CS07: 10mΩ≤R < 15mΩ: ±500ppm/°C 15mΩ≤R < 20mΩ: ±400ppm/°C 20mΩ≤R≤50mΩ: ±300ppm/°C 50mΩ < R≤1Ω: ±100ppm/°C CS10: 10mΩ≤R < 15mΩ: ±600ppm/°C 15mΩ≤R < 20mΩ: ±500ppm/°C 20mΩ≤R≤30mΩ: ±300ppm/°C 30mΩ < R≤50mΩ: ±200ppm/°C 50mΩ < R≤0.1Ω: ±150ppm/°C 0.1Ω < R≤1Ω: ±100ppm/°C CS11: 10mΩ≤R < 20mΩ: ±500ppm/°C 20mΩ≤R < 50mΩ: ±400ppm/°C 50mΩ≤R≤0.1Ω: ±200ppm/°C 0.1Ω < R≤1Ω: ±100ppm/°C CS12: 10mΩ≤R < 15mΩ: ±600ppm/°C 15mΩ≤R < 20mΩ: ±400ppm/°C 20mΩ≤R≤30mΩ: ±300ppm/°C 30mΩ < R≤50mΩ: ±200ppm/°C 50mΩ < R≤0.1Ω: ±150ppm/°C 0.1Ω < R≤1Ω: ±100ppm/°C	User Spec	Parametrically test per lot and sample size requirements, summary to show Min, Max, Mean and Standard deviation at room as well as Min and Max operating temperatures.
Short-time overload	±1%: ±(1%+0.005Ω) ±5%: ±(2%+0.005Ω)	JIS-C-5201	4.13 Permanent resistance change after the application of a potential of 2.5 times RCWV or Max. Overload Voltage whichever less for 5 seconds..
External Visual	No Mechanical Damage	MIL-STD-883 Method 2009	Electrical test not required. Inspect device construction, marking and workmanship

Physical Dimension	Reference 5. Dimension Standards	JESD22 MH Method JB-100	Verify physical dimensions to the applicable device detail specification. Note: User(s) and Suppliers spec. Electrical test not required.
Resistance to Solvent	Marking Unsmearred	MIL-STD-202 Method 215	Note: Add Aqueous wash chemical – OKEM Clean or equivalent. Do not use banned solvents.
Terminal Strength	Not broken	JIS-C-6429	Force of 1.8kg for 60 seconds.
High Temperature Exposure (Storage)	±1%: ±(1.0%+0.005Ω) ±5%: ±(3.0%+0.005Ω)	MIL-STD-202 Method 108	1000hrs. @T=155 °C .Unpowered. Measurement at 24±2 hours after test conclusion.
Temperature Cycling	±1%: ±(1.0%+0.005Ω) ±5%: ±(3.0%+0.005Ω)	JESD22 Method JA-104	1000 Cycles (-55°C to +155°C). Measurement at 24±2 hours after test conclusion.
Biased Humidity	±1%: ±(1.0%+0.005Ω) ±5%: ±(3.0%+0.005Ω)	MIL-STD-202 Method 103	1000 hours 85°C,85%RH. Note: Specified conditions: 10% of operating power. Measurement at 24±2 hours after test conclusion.
Mechanical Shock	±(1.0%+0.005Ω)	MIL-STD-202 Method 213	Wave Form: Tolerance for half sine shock pulse. Peak value is 100g's. Normal duration (D) is 6.
Vibration	±(1.0%+0.005Ω)	MIL-STD-202 Method 204	5g's for 20 min., 12cycle each of 3 orientations. Note: Use 8"*5"PCB. 031" thick 7 secure points on one long side and 2 secure points at corners of opposite sides. Parts mounted within 2' from any secure point. Test from 10-2000Hz.
Soldrability	Coverage must be over 95%.	J-STD-002	For both leaded & SMD. Electrical test not required. Magnification 50X. Conditions: a) Method B 4hrs at 155°C dry heat, the dip in bath with 245 °C,5s. b) Method D: at 260°C, 60s.
Flammability	No ignition of the tissue paper or scorching or the pinewood board	UL-94	V-0 or V-1 are acceptable. Electrical test not required.
Board Flex	±(1.0%+0.005Ω)	JIS-C-6429	2mm (Min)
Flame Retardance	No flame	AEC-Q200-001	Only requested, when voltage/power will increase the surface temp to 350°C. Apply voltage from 9V to 32V. No flame; No explosion.
Resistance to Soldering Heat	±(1.0%+0.005Ω)	MIL-STD-202 Method 210	Condition B No per-heat of samples. Note: Single Wave Solder-Procedure 2 for SMD and Procedure 1 for Leaded with solder within 1.5mm of device body.

## 11. Packing of Surface Mount Resistors

### 11.1 Dimension of Paper Taping (Unit: mm)

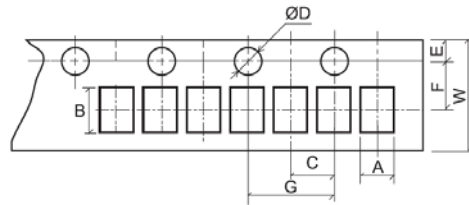

Type	A	B	C $\pm 0.05$	$\begin{matrix} +0.1 \\ \phi D \\ -0 \end{matrix}$	E $\pm 0.1$	F $\pm 0.05$	G $\pm 0.1$	W $\pm 0.2$	T $\pm 0.05$
CS02	0.65 $\pm 0.10$	1.20 $\pm 0.10$	2.00	1.50	1.75	3.50	4.00	8.00	0.42

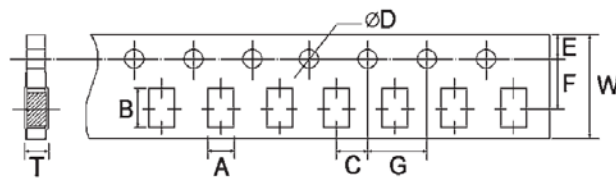

Type	A $\pm 0.2$	B $\pm 0.2$	C $\pm 0.05$	$\begin{matrix} +0.1 \\ \phi D \\ -0 \end{matrix}$	E $\pm 0.1$	F $\pm 0.05$	G $\pm 0.1$	W $\pm 0.2$	T $\pm 0.1$
CS03	1.10	1.90	2.00	1.50	1.75	3.50	4.00	8.00	0.67
CS05	1.65	2.40	2.00	1.50	1.75	3.50	4.00	8.00	0.81
CS06	2.00	3.60	2.00	1.50	1.75	3.50	4.00	8.00	0.81
CS07	2.80	3.50	2.00	1.50	1.75	3.50	4.00	8.00	0.75

### 11.2 Dimension of Embossed Taping: (Unit: mm)

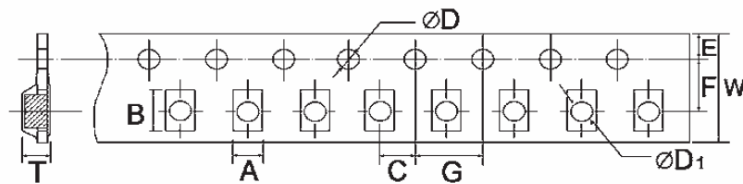

Type	A $\pm 0.2$	B $\pm 0.2$	C $\pm 0.05$	$\begin{matrix} +0.1 \\ \phi D \\ -0 \end{matrix}$	$\begin{matrix} +0.25 \\ \phi D1 \\ -0 \end{matrix}$	E $\pm 0.1$	F $\pm 0.05$	G $\pm 0.1$	W $\pm 0.2$	T $\pm 0.1$
CS10	2.90	5.60	2.00	1.50	1.50	1.75	5.50	4.00	12.00	1.00
CS11	3.50	4.80	2.00	1.50	1.50	1.75	5.50	4.00	12.00	1.00
CS12	3.50	6.70	2.00	1.50	1.50	1.75	5.50	4.00	12.00	1.00

## 11.3 Dimension of Reel : (Unit: mm)



Type	Taping	Qty/Reel	A ±0.5	B ±0.5	C ±0.5	D ±1	M ±2	W ±1
CS02	Paper	10,000pcs	2.0	13.0	21.0	60.0	178.0	10.0
CS03	Paper	5,000pcs	2.0	13.0	21.0	60.0	178.0	10.0
CS05	Paper	5,000pcs	2.0	13.0	21.0	60.0	178.0	10.0
CS06	Paper	5,000pcs	2.0	13.0	21.0	60.0	178.0	10.0
CS07	Paper	5,000pcs	2.0	13.0	21.0	60.0	178.0	10.0
CS10	Embossed	4,000pcs	2.0	13.0	21.0	60.0	178.0	13.8
CS11	Embossed	4,000pcs	2.0	13.0	21.0	60.0	178.0	13.8
CS12	Embossed	4,000pcs	2.0	13.0	21.0	60.0	178.0	13.8

12. Note

12.1. UNI-ROYAL recommend the storage condition temperature: 15°C~35°C, humidity :25%~75%.

(Put condition for individual product).Even under UNI-ROYAL recommended storage condition, solderability of products over 1 year old.  
(Put condition for each product) may be degraded.

12.2. Store / transport cartons in the correct direction, which is indicated on a carton as a symbol.

Otherwise bent leads may occur due to excessive stress applied when dropping of a carton.

12.3. Product performance and soldered connections may deteriorate if the products are stored in the following places:

- Storage in high Electrostatic.
- Storage in direct sunshine 、rain and snow or condensation.
- Where the products are exposed to sea winds or corrosive gases, including Cl<sub>2</sub>, H<sub>2</sub>S, NH<sub>3</sub>, SO<sub>2</sub>, NO<sub>2</sub>.

13. Record

Version	Description of amendment	Page	Date	Amended by	Checked by
1	First issue of this specification	1~7	Mar.20, 2018	Chen Haiyan	Chen Nana
2	1.Modify the product name 2. Modify the Performance	1~7	Nov.22, 2018	Chen Haiyan	Chen Nana
3	Modify the Performance Specification	5~6	Feb.16, 2019	Chen Haiyan	Xu Yuhua

Uniroyal Electronics Global Co., Ltd. , all rights reserved. Spec. herein would be changed at any time without prior notice.



## X-ON Electronics

Largest Supplier of Electrical and Electronic Components

*Click to view similar products for [Current Sense Resistors - SMD category](#):*

*Click to view products by [Uniroyal manufacturer](#):*

Other Similar products are found below :

[5112](#) [65709-330JE](#) [PF2512FKF7W0R007L](#) [PR2512FKF7W0R003L](#) [PR2512FKF7W0R005L](#) [RCWL0603R500JNEA](#) [ERJ-3BQF1R1V](#) [ERJ-L14UJ42MU](#) [2-2176088-5](#) [PF2512FKF7W0R006L](#) [PF2512FKF7W0R033L](#) [2-2176089-4](#) [CD2015FC-0.10-1%](#) [PR2512FKF7W0R004L](#) [CGSSL1R01J](#) [CGSSL1R047J](#) [RC1005F124CS](#) [RCWE2512R110FKEA](#) [RCWL0805R330JNEA](#) [RL73H3AR47FTE](#) [RL73K3AR56JTDF](#) [RL7520WT-R001-F](#) [RL7520WT-R009-G](#) [RL7520WT-R020-F](#) [RLP73N1ER43JTD](#) [TL3AR01FTDG](#) [TLR3A20DR0005FTDG](#) [LRC-LR2512LF-01-R820J](#) [ERJ-3BQF4R3V](#) [ERJ-L14UF68MU](#) [TLR3A20DR001FTDG](#) [TLR3A30ER0005FTDG](#) [WR06X104JGLJ](#) [RLP73K1ER82JTD](#) [TL2BR01F](#) [TLR3A20DR01FTDG](#) [WSR3R0600FEA32](#) [ERJ-14BQF1R6U](#) [ERJ-14BQJR30U](#) [SP1220RJT](#) [SP1R12J](#) [ERJ-14BQF6R2U](#) [RL7520WT-R039-G](#) [PF1206FRF7W0R02L](#) [RL7520WT-R002-F](#) [RL7520WT-R047-F](#) [RLP73N2BR068FTDF](#) [RL7520WT-R005-F](#) [RCWE2512R220FKEA](#) [RCWE120625L0FMEA](#)