

厚 聲 電 子 工 業 有 限 公 司

UNIROYAL ELECTRONICS INDUSTRY CO., LTD.



ISO14001



ISO/TS16949



24546



24546



REG.-Nr.A759



CQC04001010058



Specification for Approval

Customer : 深圳市嘉立创科技发展有限公司

Product Name : LEAD-FREE CHIP THICK FILM RESISTORS

Part Name : CHIP SERIES $\pm 0.5\%$, $\pm 1\%$, $\pm 2\%$, $\pm 5\%$ & 0Ω

88 LONG TENG ROAD, ECONOMIC AND TECHNICAL DEVELOPMENT ZONE, KUNSHAN CITY,
JIANGSU, CHINA 215301

TEL: 86 512 57631400/1411 / 1422 / 1433

FAX: 86 512 5763 4599

E-mail: globalsales@uniohm.com localsales@uniohm.com

Approved	Checked	Prepared	File NO.	Edition	Date	Page
William Zhao	Apple Liu	WangZiyuan	JLC-01-010	1	2016/09/23	1 / 14



ISO14001



ISO/TS16949



244546



245468



REG.-Nr.A759



CQC04001010058

Content

Index.....	Page
1.0 Scope.....	4
2.0 Ratings & dimension.....	4
3.0 Structure.....	5
4.0 Mark.....	6
5.0 Derating curve.....	8
6.0 Performance specification.....	9
7.0 Explanation of Part No. System.....	11
8.0 Order procedure.....	12
9.0 Standard packing.....	12
10.0 Note.....	14

Approved	Checked	Prepared	File NO.	Edition	Date	Page
William Zhao	Apple Liu	WangZiyuan	JLC-01-010	1	2016/09/23	2 / 14

厚 聲 電 子 工 業 有 限 公 司

UNIROYAL ELECTRONICS INDUSTRY CO., LTD.



ISO14001



ISO/TS16949



244546



245468



REG.-Nr.A759



CQC04001010058

File Name: CHIP SERIES ±0.5%,±1%,±2%,±5%& 0Ω			Date 2016/09/23	Edition No. 1	
Amendment Record				Signature	
Edition	Prescription of amendment	Page	Date	Amended by	Checked by

Approved	Checked	Prepared	File NO.	Edition	Date	Page
William Zhao	Apple Liu	WangZiyuan	JLC-01-010	1	2016/09/23	3 / 14



1.0 Scope:

This file is the specification for **Lead-Free Thick Film Chip Resistors** manufactured by UNIOHM S.

2.0 Ratings & dimension:

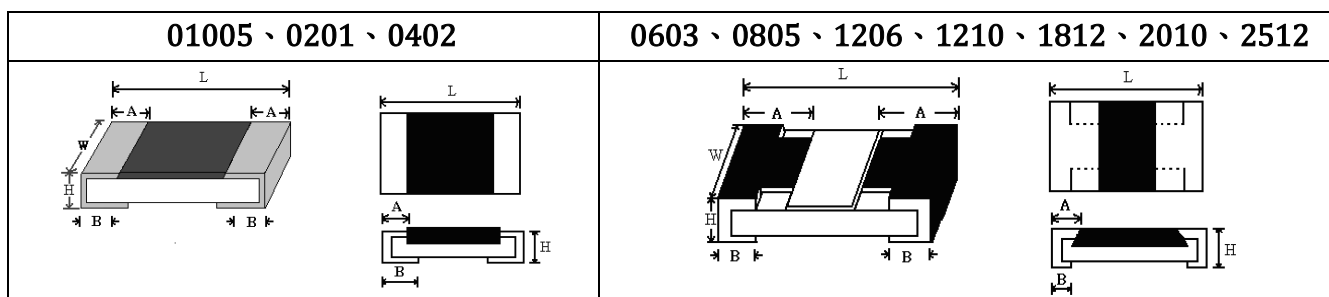

2.1 Dimension & resistance range :

Type	70°C Power	Dimension(mm)					Resistance Range			
		L	W	H	A	B	0.5%	1.0%	2.0%	5.0%
01005	1/32W	0.40±0.02	0.20±0.02	0.13±0.02	0.10±0.05	0.10±0.03	--	10Ω~10MΩ	10Ω~10MΩ	1Ω~10MΩ
0201	1/20W	0.60±0.03	0.30±0.03	0.23±0.03	0.10±0.05	0.15±0.05	--	1Ω~10MΩ	1Ω~10MΩ	1Ω~10MΩ
0402	1/16W	1.00±0.10	0.50±0.05	0.35±0.05	0.20±0.10	0.25±0.10	1Ω~10MΩ	0.1Ω~22MΩ	0.1Ω~22MΩ	0.1Ω~22MΩ
0603	1/10W	1.60±0.10	0.80±0.10	0.45±0.10	0.30±0.20	0.30±0.20	1Ω~10MΩ	0.1Ω~33MΩ	0.1Ω~33MΩ	0.1Ω~100MΩ
0805	1/8W	2.00±0.15	1.25 ^{+0.15} _{-0.10}	0.55±0.10	0.40±0.20	0.40±0.20	1Ω~10MΩ	0.1Ω~33MΩ	0.1Ω~33MΩ	0.1Ω~100MΩ
1206	1/4W	3.10±0.15	1.55 ^{+0.15} _{-0.10}	0.55±0.10	0.45±0.20	0.45±0.20	1Ω~10MΩ	0.1Ω~33MΩ	0.1Ω~33MΩ	0.1Ω~100MΩ
1210	1/2W	3.10±0.10	2.60±0.20	0.55±0.10	0.50±0.25	0.50±0.20	1Ω~10MΩ	0.1Ω~10MΩ	0.1Ω~22MΩ	0.1Ω~100MΩ
1812	3/4W	4.50±0.20	3.20±0.20	0.55±0.20	0.50±0.20	0.50±0.20	1Ω~10MΩ	0.1Ω~10MΩ	0.1Ω~10MΩ	0.1Ω~10MΩ
2010	3/4W	5.00±0.10	2.50±0.20	0.55±0.10	0.60±0.25	0.50±0.20	1Ω~10MΩ	0.1Ω~22MΩ	0.1Ω~22MΩ	0.1Ω~22MΩ
2512	1W	6.35±0.10	3.20±0.20	0.55±0.10	0.60±0.25	0.50±0.20	1Ω~10MΩ	0.1Ω~33MΩ	0.1Ω~33MΩ	0.1Ω~33MΩ

Approved	Checked	Prepared	File NO.	Edition	Date	Page
William Zhao	Apple Liu	WangZiyuan	JLC-01-010	1	2016/09/23	4 / 14

2.2 Ratings:

Type	70°C Power	Max working voltage	Max overload voltage	Dielectric withstanding voltage	Range of Jumper	Rated current of Jumper	Max rated current of Jumper	Operating Temperature
01005	1/32W	15V	30V	--	--	--	--	-55°C~155°C
0201	1/20W	25V	50V	--	<50mΩ	0.5A	1A	-55°C~155°C
0402	1/16W	50V	100V	100V	<50mΩ	1A	2A	-55°C~155°C
0603	1/10W	75V	150V	300V	<50mΩ	1A	2A	-55°C~155°C
0805	1/8W	150V	300V	500V	<50mΩ	2A	5A	-55°C~155°C
1206	1/4W	200V	400V	500V	<50mΩ	2A	10A	-55°C~155°C
1210	1/2W	200V	500V	500V	<50mΩ	2A	10A	-55°C~155°C
1812	3/4W	200V	500V	500V	<50mΩ	2A	10A	-55°C~155°C
2010	3/4W	200V	500V	500V	<50mΩ	2A	10A	-55°C~155°C
2512	1W	200V	500V	500V	<50mΩ	2A	10A	-55°C~155°C

3.0 Structure:

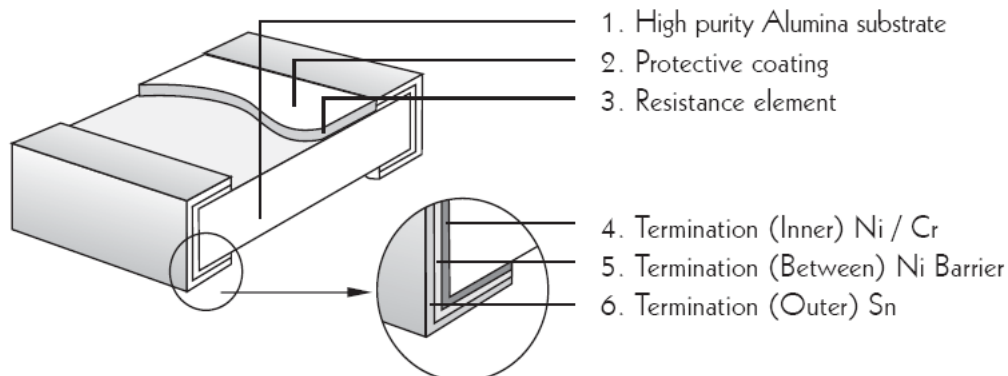

Approved	Checked	Prepared	File NO.	Edition	Date	Page
William Zhao	Apple Liu	WangZiyuan	JLC-01-010	1	2016/09/23	5 / 14



4.0 Mark:

4.1 For 01005、0201 and 0402 size: Due to tiny size, there is no marking on the body.

Example:



01005、0201、0402

4.2 For $\pm 2\%$, $\pm 5\%$ tolerance:

4.2.1 There are three codes on body. Two digits ahead are significant figures of value, and 3rd digit is the power of ten.

Example:



33000 \rightarrow 33K Ω

4.2.2 If resistance value is below 10 Ω , the mark would be made up by number and letter "R" which is used as decimal point.

Example:



1R5 \rightarrow 1.5 Ω

4.3 For $\pm 0.5\%$ 、 $\pm 1\%$ tolerance resistors:

There are 4 codes on body. Three codes ahead are significant, and 4th code is power of ten. Letter "R" is used to represent decimal point.



2701 \rightarrow 2.7K Ω



10R0 \rightarrow 10 Ω

4.4 For 0603 size:

4.4.1 If resistance value belongs to E-24 Series Standard Value but not in E-96 Series Standard Values ($\pm 0.5\%$ 、 $\pm 1\%$ tolerance), mark is same as 5% tolerance resistors but with underline.



333 = 33000 \rightarrow 33K Ω



680 \rightarrow 68 Ω

Approved	Checked	Prepared	File NO.	Edition	Date	Page
William Zhao	Apple Liu	WangZiyuan	JLC-01-010	1	2016/09/23	6 / 14



4.4.2 If resistance value belongs to E-96 Series Standard Values ($\pm 0.5\%$ 、 $\pm 1\%$ tolerance):

Due to tiny size, value will be described with 3 codes such as following power & resistance code.

Power code:

Code	A	B	C	D	E	F	G	H	X	Y	Z
Power	10^0	10^1	10^2	10^3	10^4	10^5	10^6	10^7	10^{-1}	10^{-2}	10^{-3}

Resistance code:

Two code ahead: Resistance code

Third code: Power code

Example: $1.96K\Omega = 196 \times 10^{-1}\Omega$ -----29B

$12.4\Omega = 124 \times 10^{-1}\Omega$ -----10X



E-96 STANDARD VALUES AND 0603 RESISTANCE CODE

VALUE	CODE	VALUE	CODE	VALUE	CODE	VALUE	CODE
100	01	178	25	316	49	562	73
102	02	182	26	324	50	576	74
105	03	187	27	332	51	590	75
107	04	191	28	340	52	604	76
110	05	196	29	348	53	619	77
113	06	200	30	357	54	634	78
115	07	205	31	365	55	649	79
118	08	210	32	374	56	665	80
121	09	215	33	383	57	681	81
124	10	221	34	392	58	698	82
127	11	226	35	402	59	715	83
130	12	232	36	412	60	732	84
133	13	237	37	422	61	750	85
137	14	243	38	432	62	768	86
140	15	249	39	442	63	787	87
143	16	255	40	453	64	806	88
147	17	261	41	464	65	825	89
150	18	267	42	475	66	845	90
154	19	274	43	487	67	866	91
158	20	280	44	499	68	887	92
162	21	287	45	511	69	909	93
165	22	294	46	523	70	931	94
169	23	301	47	536	71	953	95
174	24	309	48	549	72	976	96

Approved	Checked	Prepared	File NO.	Edition	Date	Page
William Zhao	Apple Liu	WangZiyuan	JLC-01-010	1	2016/09/23	7 / 14



4.5 For 0805, 1206, 1210, 1812, 2010 and 2512 size:

If resistance value is below 1Ω, 1st code would be letter “R”.



R300→0.3Ω

4.6 0Ω mark:

4.6.1 For 01005, 0201 and 0402 size, there is no marking on body:



4.6.2 For 0603, 0805, 1206, 1210, 1812, 2010, 2512 size, 0Ω resistors' marking as following:



5.0 Derating curve:

Resistors shall have a power rating based on continuous load operation at an ambient temperature from -55°C to 70°C. For temperature in excess of 70°C, the load shall be derate as shown in figure 1

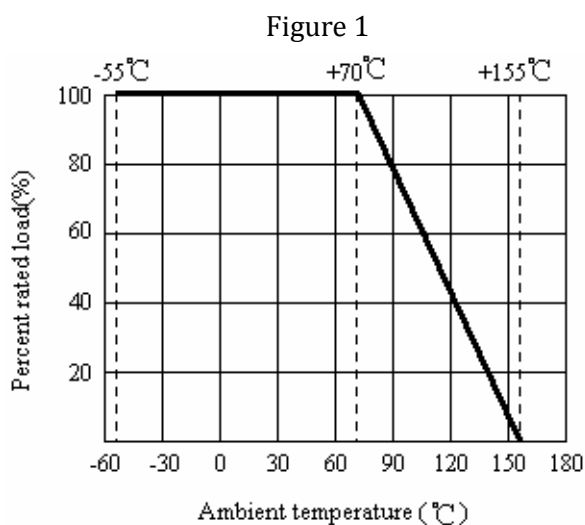

Approved	Checked	Prepared	File NO.	Edition	Date	Page
William Zhao	Apple Liu	WangZiyuan	JLC-01-010	1	2016/09/23	8 / 14



5.1 Voltage rating:

Resistors should have a direct-current (DC) continuous voltage rating and an alternating-current (AC) continuous voltage rating relates to Power Rating, formula shown as below:

$$RCWV = \sqrt{P * R}$$

RCWV: Rated dc or RMS ac continuous working voltage at commercial-line frequency and waveform (Volt.)

P: Power Rating (Watt.)

R: Nominal Resistance (Ohm)

Resistors will be burned out if it overload, such as higher than the maximum value of series' RCWV. And we named 2.5 times RCWV is OVERLOAD Voltage.

6.0 Performance specification:

Item	Limits	Test Method (JIS-C-5201& JIS-C-5202)
Temperature Coefficient	01005: 1Ω≤R≤10Ω: ±600PPM/°C 10Ω<R≤100Ω: ±400PPM/°C >100Ω: ±250PPM/°C	4.8 Natural resistance changes per temp. Degree centigrade $\frac{R_2 - R_1}{R_1(T_2 - T_1)} * 10^6 (PPM/°C)$ R ₁ : resistance value at room temp. (T ₁) R ₂ : resistance value at room temp. +100°C (T ₂) Test pattern: room temp. (T ₁), room temp. +100°C(T ₂)
	0201: 1Ω≤R≤10Ω: -100~+350PPM/°C >10Ω: ±200PPM/°C	
	0402: 0.1Ω≤R<1Ω: ±800PPM/°C 1Ω≤R≤10Ω: ±400PPM/°C >10Ω: ±100PPM/°C	
	0603: 0.1Ω≤R < 1Ω: ±800PPM/°C 1Ω≤R≤10Ω: ±400PPM/°C 10Ω<R≤100Ω: ±200PPM/°C >10Ω: ±100PPM/°C	
	0805~2512 : 0.1Ω≤R < 1Ω: ±800PPM/°C 1Ω≤R≤10Ω: ±400PPM/°C >10Ω: ±100PPM/°C	
Short-time overload	±0.5%,±1%	±(1%+0.1Ω) Max.
	±2%,±5%	±(2%+0.1Ω) Max.
	01005	±(2%+0.1Ω) Max
	<50mΩ	
* Dielectric withstanding voltage	No evidence of flashover mechanical damage, arcing or insulation breaks down.	4.7 Resistors shall be clamped in the trough of a 90°cmetallic v-block and shall be tested at ac potential respectively specified in the given list of each product type for 60-70 seconds.

Approved	Checked	Prepared	File NO.	Edition	Date	Page
William Zhao	Apple Liu	WangZiyuan	JLC-01-010	1	2016/09/23	9 / 14

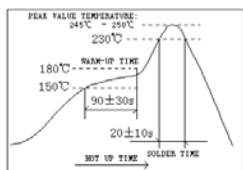

Item	Limits		Test Method (JIS-C-5201& JIS-C-5202)															
Solderability	95% coverage Min.		Wave solder: Test temperature of solder: 245°C±3°C dipping time in solder: 2-3 seconds.															
	Go up tin rate bigger than half of end pole		Reflow: 															
Temperature cycling	±0.5%,±1%	±(0.5%+0.05Ω)Max	4.19Resistance change after continuous five cycles for duty cycle specified below: <table border="1" data-bbox="802 817 1393 985"> <thead> <tr> <th>Step</th> <th>Temperature</th> <th>Time</th> </tr> </thead> <tbody> <tr> <td>1</td> <td>-55°C±3°C</td> <td>30 min</td> </tr> <tr> <td>2</td> <td>Room temp.</td> <td>10 --- 15 min</td> </tr> <tr> <td>3</td> <td>+155°C±2°C</td> <td>30 min</td> </tr> <tr> <td>4</td> <td>Room temp.</td> <td>10 --- 15 min</td> </tr> </tbody> </table>	Step	Temperature	Time	1	-55°C±3°C	30 min	2	Room temp.	10 --- 15 min	3	+155°C±2°C	30 min	4	Room temp.	10 --- 15 min
	Step	Temperature		Time														
	1	-55°C±3°C		30 min														
2	Room temp.	10 --- 15 min																
3	+155°C±2°C	30 min																
4	Room temp.	10 --- 15 min																
±2%,±5%	±(1.0%+0.05Ω) Max																	
01005	±(1%+0.05Ω) Max																	
Soldering heat	Resistance change rate must be in ±(1%+0.05Ω)		4.18 Dip the resistor into a solder bath having a temperature of 260°C±5°C and hold it for 10±1 seconds.															
Terminal bending	±(1%+0.05Ω) Max		4.33 Twist of test board: Y/X = 3/90 mm for 60Seconds															
* Insulation resistance	1,000MΩ or more		4.6 the measuring voltage shall be ,measured with a direct voltage of (100±15)V or a voltage equal to the dielectric withstanding voltage., and apply for 1min															
Humidity (steady state)	±0.5%,±1%	±(0.5%+0.1Ω) Max.	4.24Temporary resistance change after 240 hours exposure in a humidity test chamber controlled at 40±2°C and 90-95% relative humidity,															
	±2%,±5%	±(3.0%+0.1Ω) Max.																
	01005	±(3.0%+0.05Ω) Max.																
*Load life in humidity	±0.5%,±1%	±(1%+0.1Ω)max.	7.9 Resistance change after 1,000 hours (1.5 hours "ON",0.5 hour "OFF") at RCWV in a humidity chamber controlled at 40°C±2°C and 90 to 95% relative humidity.															
	±2%,±5%	±(3%+0.1Ω)Max.																
	01005	±(3.0%+0.05Ω) Max.																
	<50mΩ		Apply to rated current for 0Ω															
*Load life	±0.5%,±1%	±(1%+0.1Ω)Max.	4.25.1 Permanent resistance change after 1,000 hours operating at RCWV with duty cycle 1.5 hours "ON", 0.5 hour "OFF" at 70°C±2°C ambient.															
	±2%,±5%	±(3%+0.1Ω)Max																
	01005	±(3.0%+0.05Ω) Max.																
	<50mΩ		Apply to rated current for 0Ω															
The resistors of 0Ω only can do the characteristic noted of *																		
The resistors of 01005 & 0201 only can do the characteristic noted of ◎																		

Approved	Checked	Prepared	File NO.	Edition	Date	Page
William Zhao	Apple Liu	WangZiyuan	JLC-01-010	1	2016/09/23	10 / 14



7.0 Explanation of Part No. System:

The standard Part No. includes 14 codes:

7.1 1st ~4th code: Type name

Example: 01005, 0201, 0402, 0603, 0805, 1206, 1210, 2010, 1812, 2512

7.2 5th~6th code: Power rating.

W=Normal Size; "1"~"G" to denotes "1"~"16" as Hexadecimal:

Wattage	1/32	3/4W	1/2	1/3	1/4	1/8	1/10	1/16	1/20W	1
Normal Size	WH	07	W2	W3	W4	W8	WA	WG	WM	1W

If power rating is less or equal to 1 watt, 5th code will be the letters W which represent the size required, and 6th code will be a number or a letter code.

Example: WA=1/10W

7.3 7th code: Tolerance.

D=±0.5% F=±1% G=±2% J=±5%

7.4 8th to 11th code: Resistance Value.

7.4.1 For standard values of 5% tolerance:

8th code:, it must be "0".

9th & 10th code: significant figures of the resistance.

11th digit: power of ten.

7.4.2 For standard values of ≤2% tolerance:

8th~10th codes: significant figures of the resistance.

11th digit: power of ten.

7.4.3 The following codes are used to represent power of ten:

0=10⁰ 1=10¹ 2=10² 3=10³ 4=10⁴ 5=10⁵

6=10⁶ J=10⁻¹ K=10⁻² L=10⁻³ M=10⁻⁴

7.5 12th, 13th & 14th codes.

7.5.1 12th code: Packaging Type:

T=Tape/Reel

7.5.2 13th code: Packing Quantity

4=4000pcs 5=5000pcs C=10000pcs D=20000pcs E=15000pcs

7.5.3 14th code: Special features

E: Environmental Protection, Lead Free type.

S: Special features, such as: Embossed tape, different marking requirement, etc.

Approved	Checked	Prepared	File NO.	Edition	Date	Page
William Zhao	Apple Liu	WangZiyuan	JLC-01-010	1	2016/09/23	11 / 14



8.0 Order procedure: (Example:0603 1/10W ±5% 1K T/R-5000)

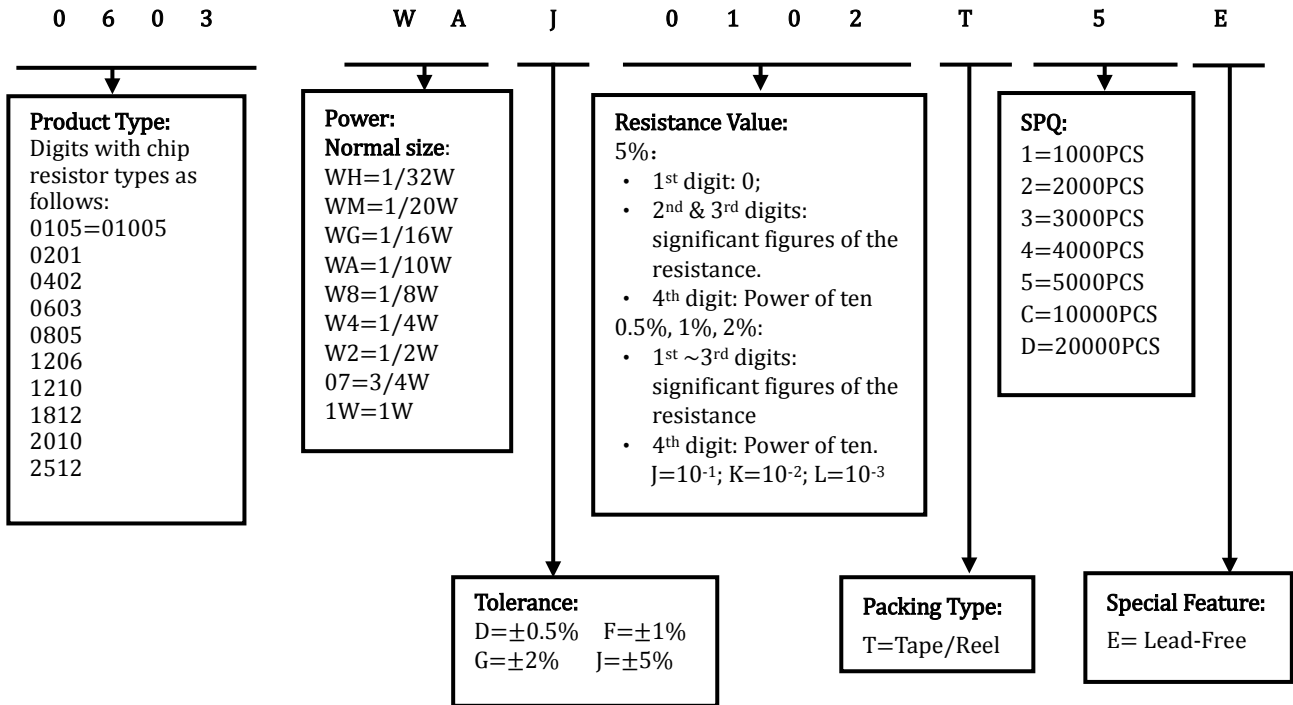

9.0 Packaging:

9.1 Tapping dimension:

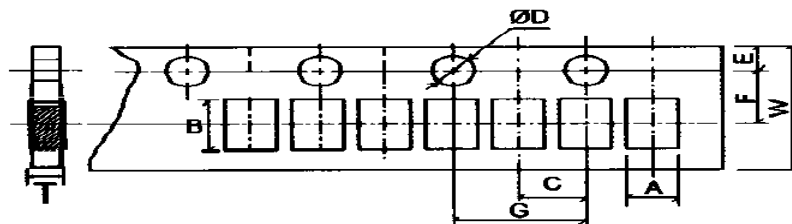

Unit: mm

Type	A	B	C±0.05	ØD ^{+0.1} _{-0.0}	E±0.1	F±0.05	G±0.1	W±0.2	T±0.1
01005	0.24±0.05	0.45±0.05	2.00	1.50	1.75	3.50	4.00	8.00	0.40
0201	0.40±0.05	0.70±0.05	2.00	1.50	1.75	3.50	4.00	8.00	0.42
0402	0.65±0.20	1.15±0.20	2.00	1.50	1.75	3.50	4.00	8.00	0.45

Approved	Checked	Prepared	File NO.	Edition	Date	Page
William Zhao	Apple Liu	WangZiyuan	JLC-01-010	1	2016/09/23	12 / 14



ISO14001



ISO/TS16949



244546



245468



REG.-Nr.A759



CQC04001010058

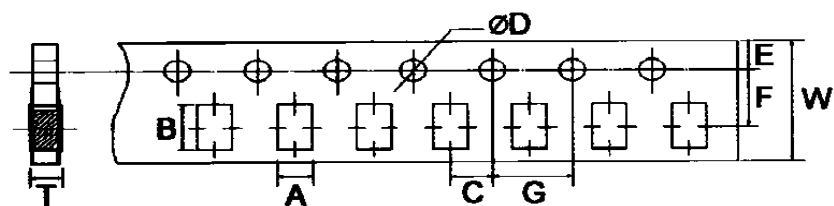

Unit: mm

Type	A±0.2	B±0.2	C±0.05	$\varnothing D_{-0.0}^{+0.1}$	E±0.1	F±0.05	G±0.1	W±0.2	T±0.1
0603	1.10	1.90	2.00	1.50	1.75	3.50	4.00	8.00	0.67
0805	1.65	2.40	2.00	1.50	1.75	3.50	4.00	8.00	0.81
1206	2.00	3.60	2.00	1.50	1.75	3.50	4.00	8.00	0.81
1210	2.80	3.50	2.00	1.50	1.75	3.50	4.00	8.00	0.75
2010	2.80	5.40	2.00	1.50	1.75	5.50	4.00	12.00	0.75

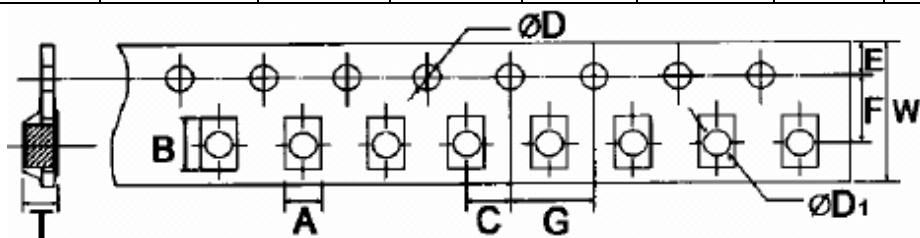

Unit: mm

Type	A±0.2	B±0.2	C±0.05	$\varnothing D_{-0.0}^{+0.1}$	$\varnothing D1_{-0.0}^{+0.25}$	E±0.1	F±0.05	G±0.1	W±0.2	T±0.1
1812	3.50	4.80	2.00	1.50	1.50	1.75	5.50	4.00	12.00	1.00
2512	3.50	6.70	2.00	1.50	1.50	1.75	5.50	4.00	12.00	1.00

9.2 Dimension:

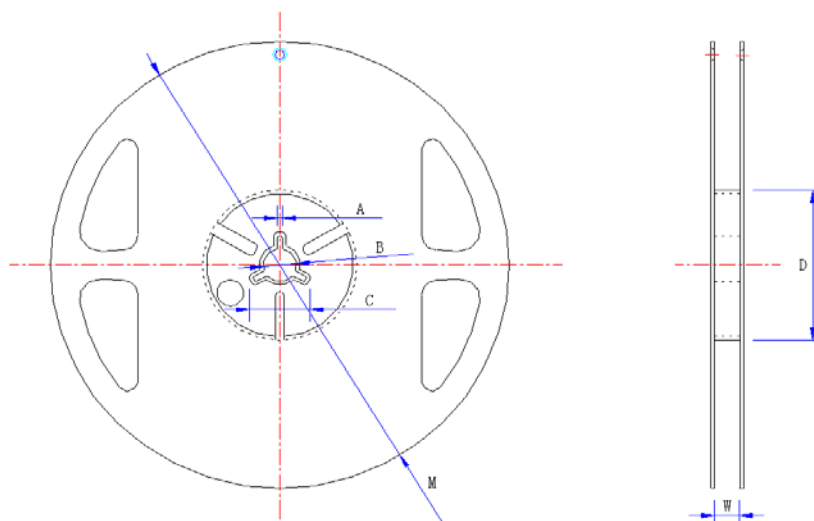

Approved	Checked	Prepared	File NO.	Edition	Date	Page
William Zhao	Apple Liu	WangZiyuan	JLC-01-010	1	2016/09/23	13 / 14



Unit: mm

Type	Taping	Qty/Reel	A±0.5	B±0.5	C±0.5	D±1	M±2	W±1
01005	Paper	20,000pcs	2.0	13.0	21.0	60.0	178.0	10.0
0201	Paper	10,000pcs	2.0	13.0	21.0	60.0	178.0	10.0
0402	Paper	10,000pcs	2.0	13.0	21.0	60.0	178.0	10.0
0603	Paper	5,000pcs	2.0	13.0	21.0	60.0	178.0	10.0
0805	Paper	5,000pcs	2.0	13.0	21.0	60.0	178.0	10.0
1206	Paper	5,000pcs	2.0	13.0	21.0	60.0	178.0	10.0
1210	Paper	5,000pcs	2.0	13.0	21.0	60.0	178.0	10.0
2010	Paper or Embossed	4,000pcs	2.0	13.0	21.0	60.0	178.0	13.8
1812	Embossed	4,000pcs	2.0	13.0	21.0	60.0	178.0	13.8
2512	Embossed	4,000pcs	2.0	13.0	21.0	60.0	178.0	13.8

10.0 Note:

10.1 UNIOHM’ S recommend the storage condition as temperature: 15°C~35°C, humidity: 25%~75%.

Even under storage condition above-mentioned, resistors’ solderability still degrades day by day.

10.2 Store / delivery cartons must be put by correct direction; otherwise product will crack or bent.

10.3 Product performance and soldered connections may deteriorate if the products are stored in the following places:

10.3.1 In high electrostatic

10.3.2 Direct sunshine, rain, snow or condensation

10.3.3 Exposed to sea winds or corrosive gases, including Cl₂, H₂S, NH₃, SO₂, and NO₂.

Approved	Checked	Prepared	File NO.	Edition	Date	Page
William Zhao	Apple Liu	WangZiyuan	JLC-01-010	1	2016/09/23	14 / 14

X-ON Electronics

Largest Supplier of Electrical and Electronic Components

Click to view similar products for [Current Sense Resistors - SMD category](#):

Click to view products by [Uniroyal manufacturer](#):

Other Similar products are found below :

[CRL0603-FW-R700ELF](#) [PFS35-200RF1](#) [NPS 2-T126 5.000 OHM 1%](#) [PFS35-0R01J1](#) [PFS35-0R05J1](#) [PFS35-5RF1](#) [CD2015FC-0.10-1%](#)
[PR2512FKF7W0R004L](#) [RC1005F124CS](#) [RL73K3AR56JTDF](#) [RL7520WT-R001-F](#) [RL7520WT-R009-G](#) [RL7520WT-R020-F](#)
[RLP73N1ER43JTD](#) [LRC-LR2512LF-01-R820J](#) [WR06X104JGLJ](#) [TL2BR01F](#) [65709-330](#) [SP1R12J](#) [RL7520WT-R039-G](#) [RL7520WT-R002-F](#)
[LRF2010-R003JW](#) [KRL1632E-C-R200-F-T5](#) [KRL1632E-C-R200-F-T1](#) [Y14880R02000B9R](#) [RLP73M1ER051FTDF](#) [RLP73M2AR051FTDF](#)
[RLP73M2AR075FTDF](#) [RLP73M1JR051FTDF](#) [RLP73N1JR47FTDF](#) [SR731ERTTP5R10F](#) [SR731ERTTP100J](#) [SR731ERTTP6R80F](#)
[SR731ERTTP4R70F](#) [SR731ERTTP2R20F](#) [SR731ERTTP3R90F](#) [SR731ERTTP1R00F](#) [SR731ERTTP10R0F](#) [SR731ERTTP2R00F](#)
[SR731ERTTP8R20F](#) [SR731ERTTP3R9J](#) [SR731ERTTP8R2J](#) [SR731ERTTP2R0J](#) [SR731ERTTP4R7J](#) [SR731ERTTP9R1J](#) [SR731ERTTP1R0J](#)
[SR731ERTTP2R2J](#) [SR731ERTTP5R1J](#) [SR731ERTTP6R8J](#) [SR731ERTTP9R10F](#)