



ISO14001



ISO/TS16949



244546



245468



REG.-Nr.A759



CQC04001010658

Specification for Approval

Customer : 深圳市陽和通電子有限公司

Product Name: Thick Film Chip Resistors

Part Name : CHIP SERIES $\pm 0.5\%$, $\pm 1\%$, $\pm 2\%$, $\pm 5\%$ & 0Ω

Building 8, Jiuwei Industrial Zone, Xixiang Town, Bao'An District ,Shenzhen, Guangdong, China
Guangdong Province, China

TEL: 0755-27484508

FAX: 0755-27484308

Approved	Checked	Prepared	File NO.	Edition	Date	Page
William Zhao	Ted Hsu	Chengxia Tang	YHT-01-034	1	2017/08/18	1/16



ISO14001



ISO/TS16949



244546



245468



REG.-Nr.A759



CQC04001010658

Contents

Introduction	Page
1.0 Scope	4
2.0 Ratings & Dimension	4~6
3.0 Structure.....	6
4.0 Marking.....	7~9
5.0 Derating Curve.....	9
6.0 Performance Specification	10~11
7.0 Explanation of Part No. System	12
8.0 Ordering Procedure	13
9.0 Standard Packing	13~15
10.0 Note Matter.....	16

Approved	Checked	Prepared	File NO.	Edition	Date	Page
William Zhao	Ted Hsu	Chengxia Tang	YHT-01-034	1	2017/08/18	2/16

厚聲國際貿易（昆山）有限公司深圳分公司
Uniroyal Electronics Global Co.,Ltd Shenzhen Branch



ISO14001



ISO/TS16949



244546



245468



REG.-Nr.A759



CQC04001010050

File Name: CHIP SERIES ±0.5%,±1%,±2%,±5% & 0Ω		Date	2017/08/18	Edition No.	1
Amendment Record				Signature	
Edition	Prescription of amendment	Amend Page	Amend Date	Amended by	Checked by

Approved	Checked	Prepared	File NO.	Edition	Date	Page
William Zhao	Ted Hsu	Chengxia Tang	YHT-01-034	1	2017/08/18	3/16



ISO14001



ISO/TS16949



244546



245468



REG.-Nr.A759



CQC04001010658

1.0 Scope:

This specification for approve relates to the Thick Film Chip Resistors manufactured by UNIOHM.

2.0 Ratings:

01005、0201、0402	0603、0805、1206、1210、1812、2010、2512
	

2.1 Dimension:

Type	Dimension(mm)				
	L	W	H	A	B
01005	0.40±0.02	0.20±0.02	0.13±0.02	0.10±0.05	0.10±0.03
0201	0.60±0.03	0.30±0.03	0.23±0.03	0.10±0.05	0.15±0.05
0402	1.00±0.10	0.50±0.05	0.35±0.05	0.20±0.10	0.25±0.10
0603	1.60±0.10	0.80±0.10	0.45±0.10	0.30±0.20	0.30±0.20
0805	2.00±0.15	1.25 ^{+0.15} -0.10	0.55±0.10	0.40±0.20	0.40±0.20
1206	3.10±0.15	1.55 ^{+0.15} -0.10	0.55±0.10	0.45±0.20	0.45±0.20
1210	3.10±0.10	2.60±0.20	0.55±0.10	0.50±0.25	0.50±0.20
1812	4.50±0.20	3.20±0.20	0.55±0.20	0.50±0.20	0.50±0.20
2010	5.00±0.10	2.50±0.20	0.55±0.10	0.60±0.25	0.50±0.20
2512	6.35±0.10	3.20±0.20	0.55±0.10	0.60±0.25	0.50±0.20

Approved	Checked	Prepared	File NO.	Edition	Date	Page
William Zhao	Ted Hsu	Chengxia Tang	YHT-01-034	1	2017/08/18	4/16



ISO14001



ISO/TS16949



244546



245468



REG.-Nr.A759



CQC04001010658

2.2 Resistance Range:

Type	70 °C Power	Resistance Range			
		0.5%	1.0%	2.0%	5.0%
01005	1/32W	--	10 Ω -10M Ω	10 Ω -10M Ω	1 Ω -10M Ω
0201	1/20W	--	1 Ω -10M Ω	1 Ω -10M Ω	1 Ω -10M Ω
0402	1/16W	1 Ω -10M Ω	1 Ω ~10M Ω	1 Ω ~10M Ω	1 Ω ~10M Ω
0603	1/10W	1 Ω -10M Ω	0.1 Ω ~10M Ω	0.1 Ω ~10M Ω	0.1 Ω ~10M Ω
0805	1/8W	1 Ω -10M Ω	0.1 Ω ≤R<10M Ω	0.1 Ω ≤R<10M Ω	0.1 Ω ≤R<10M Ω
	1/4W	/	0.01 Ω ≤R<0.1 Ω	0.01 Ω ≤R<0.1 Ω	0.01 Ω ≤R<0.1 Ω
1206	1/4W	1 Ω -10M Ω	0.1 Ω ≤R<10M Ω	0.1 Ω ≤R<10M Ω	0.1 Ω ≤R<10M Ω
	1/3W	/	0.01 Ω ≤R<0.1 Ω	0.01 Ω ≤R<0.1 Ω	0.01 Ω ≤R<0.1 Ω
1210	1/2W	1 Ω -10M Ω	0.01 Ω ~10M Ω	0.01 Ω ~10M Ω	0.01 Ω ~10M Ω
1812	3/4W	1 Ω -10M Ω	0.01 Ω -10M Ω	0.01 Ω -10M Ω	0.01 Ω -10M Ω
2010	3/4W	1 Ω -10M Ω	0.01 Ω ~10M Ω	0.01 Ω ~10M Ω	0.01 Ω ~10M Ω
2512	1W	1 Ω -10M Ω	0.01 Ω ~10M Ω	0.01 Ω ~10M Ω	0.01 Ω ~10M Ω

Approved	Checked	Prepared	File NO.	Edition	Date	Page
William Zhao	Ted Hsu	Chengxia Tang	YHT-01-034	1	2017/08/18	5/16



ISO14001



ISO/TS16949



244546



245468



REG.-Nr.A759



CQC04001010658

2.3 Ratings:

Type	Max. Working Voltage	Max. Overload Voltage	Dielectric withstanding Voltage	Resistance Value of Jumper	Rated Current of Jumper	Max. Overload Current of Jumper	Operating Temperature
01005	15V	30V	--	<50m Ω	0.5A	1A	-55℃~155℃
0201	25V	50V	--	<50m Ω	0.5A	1A	-55℃~155℃
0402	50V	100V	100V	<50m Ω	1A	2A	-55℃~155℃
0603	75V	150V	300V	<50m Ω	1A	2A	-55℃~155℃
0805	150V	300V	500V	<50m Ω	2A	5A	-55℃~155℃
1206	200V	400V	500V	<50m Ω	2A	10A	-55℃~155℃
1210	200V	500V	500V	<50m Ω	2A	10A	-55℃~155℃
1812	200V	500V	500V	<50m Ω	2A	10A	-55℃~155℃
2010	200V	500V	500V	<50m Ω	2A	10A	-55℃~155℃
2512	200V	500V	500V	<50m Ω	2A	10A	-55℃~155℃

3.0 Structure:



Approved	Checked	Prepared	File NO.	Edition	Date	Page
William Zhao	Ted Hsu	Chengxia Tang	YHT-01-034	1	2017/08/18	6/16



4.0 Marking:

(1) For 01005、0201 and 0402 size. Due to the very small size of the resistor's body, there is no marking on the body.

Example:



01005、0201、0402

(2) $\pm 2\%$ 、 $\pm 5\%$ Tolerance: The first two digits are significant figures of resistance and the third denotes number of zeros following

Example:



333 \rightarrow 33K Ω

(3) $\pm 2\%$ 、 $\pm 5\%$ Tolerance: Below 10 Ω show as following, read alphabet "R" as decimal point.

Example:



2R2 \rightarrow 2.2 Ω

(4) $\pm 0.5\%$ 、 $\pm 1\%$ Tolerance: 4 digits, first three digits are significant; forth digit is number of zeros. Letter r is decimal point.



2701 \rightarrow 2.7K Ω



10R0 \rightarrow 10 Ω

(5) standard E-24 and not belong to E-96 series values (in $\pm 0.5\%$ 、 $\pm 1\%$ tolerance) of 0603 size the marking is the same as 5% tolerance but marking as underline



333 \rightarrow 33K Ω



680 \rightarrow 68 Ω

(6) More than 0805 specifications (including) 4 digits, Product below 1 Ω , show as following, the first digit is "R" which as decimal point.



R300 \rightarrow 0.3 Ω

Approved	Checked	Prepared	File NO.	Edition	Date	Page
William Zhao	Ted Hsu	Chengxia Tang	YHT-01-034	1	2017/08/18	7/16

厚聲國際貿易（昆山）有限公司深圳分公司 Uniroyal Electronics Global Co.,Ltd Shenzhen Branch



ISO14001



ISO/TS16949



244546



245468



REG.-Nr.A759



GQC04001010656

(7) Standard E-96 series values ($\pm 0.5\%$ 、 $\pm 1\%$ tolerance) of 0603 size. Due the small size of the resistor's body, 3 digits marking will be used to indicate the accurate resistance value by using the following multiplier & resistance code.

Multiplier code:

Code	A	B	C	D	E	F	G	H	X	Y	Z
Multiplier	10^0	10^1	10^2	10^3	10^4	10^5	10^6	10^7	10^{-1}	10^{-2}	10^{-3}

Coding formula

First two digits-----Resistance code Third digit-----Multiplier code

EXAMPLE: $1.96K\Omega = 196 \times 10^1\Omega$ -----29B

$12.4\Omega = 124 \times 10^{-1}\Omega$ -----10X



STANDARD E-96 VALUES AND 0603 RESISTANCE CODE

Ω VALUE	CODE	Ω VALUE	CODE	Ω VALUE	CODE	Ω VALUE	CODE
100	01	178	25	316	49	562	73
102	02	182	26	324	50	576	74
105	03	187	27	332	51	590	75
107	04	191	28	340	52	604	76
110	05	196	29	348	53	619	77
113	06	200	30	357	54	634	78
115	07	205	31	365	55	649	79
118	08	210	32	374	56	665	80
121	09	215	33	383	57	681	81
124	10	221	34	392	58	698	82
127	11	226	35	402	59	715	83
130	12	232	36	412	60	732	84
133	13	237	37	422	61	750	85
137	14	243	38	432	62	768	86
140	15	249	39	442	63	787	87
143	16	255	40	453	64	806	88
147	17	261	41	464	65	825	89
150	18	267	42	475	66	845	90
154	19	274	43	487	67	866	91
158	20	280	44	499	68	887	92
162	21	287	45	511	69	909	93
165	22	294	46	523	70	931	94
169	23	301	47	536	71	953	95
174	24	309	48	549	72	976	96

Approved	Checked	Prepared	File NO.	Edition	Date	Page
William Zhao	Ted Hsu	Chengxia Tang	YHT-01-034	1	2017/08/18	8/16



(8) 0Ω Marking:

Normally for 01005、0201 and 0402 size, no marking on the body:



Normally, the marking of 0Ω 0603, 0Ω 0805, 0Ω 1206, 0Ω 1210, 0Ω 1812, 0Ω 2010, 0Ω 2512 resistors as following



5.0 Derating Curve:

Resistors shall have a power rating based on continuous load operation at an ambient temperature from -55°C to 70°C. For temperature in excess of 70°C, the load shall be derate as shown in figure 1

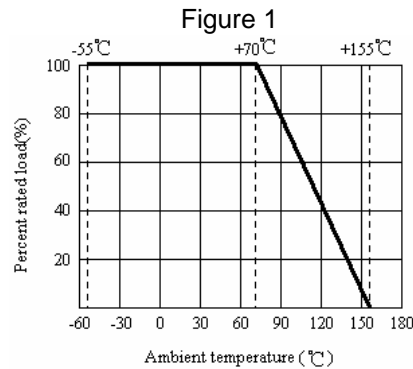

5.1 Voltage rating:

Resistors shall have a rated direct-current (DC) continuous working Voltage or an approximate sine-wave root-mean-square (RMS) alternating-current (AC) continuous working voltage at commercial-line frequency and waveform corresponding to the power rating, as determined from the following formula:

$$RCWV = \sqrt{P \times R}$$

Where: RCWV commercial-line frequency and waveform (Volt.)

P = power rating (WATT.) R = nominal resistance (OHM)

In no case shall the rated DC or RMS AC continuous working voltage be greater than the applicable maximum value.

The overload voltage is 2.5 times RCWV or Max. Overload voltage whichever is less.

Approved	Checked	Prepared	File NO.	Edition	Date	Page
William Zhao	Ted Hsu	Chengxia Tang	YHT-01-034	1	2017/08/18	9/16



ISO14001



ISO/TS16949



244546



245468



REG.-Nr.A759



GQC04001010656

6.0 Performance Specification:

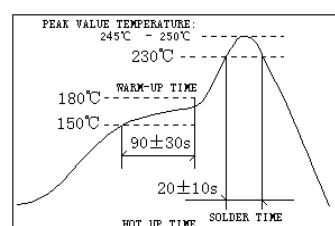
Characteristic	Limits	Test Method (JIS-C-5201& JIS-C-5202)						
◎Temperature Coefficient	01005: $1\Omega \leq R \leq 10\Omega$: $\pm 600\text{PPM}/^\circ\text{C}$ $10\Omega < R \leq 100\Omega$: $\pm 400\text{PPM}/^\circ\text{C}$ $> 100\Omega$: $\pm 250\text{PPM}/^\circ\text{C}$ 0201: $1\Omega \leq R \leq 10\Omega$: $-100 \sim + 350\text{PPM}/^\circ\text{C}$ $> 10\Omega$: $\pm 200\text{PPM}/^\circ\text{C}$ 0402: $1\Omega \leq R \leq 10\Omega$: $\pm 400\text{PPM}/^\circ\text{C}$ $> 10\Omega$: $\pm 100\text{PPM}/^\circ\text{C}$ 0603: $0.1\Omega \leq R < 1\Omega$: $\pm 800\text{PPM}/^\circ\text{C}$ $1\Omega \leq R \leq 10\Omega$: $\pm 400\text{PPM}/^\circ\text{C}$ $10\Omega < R \leq 100\Omega$: $\pm 200\text{PPM}/^\circ\text{C}$ $> 100\Omega$: $\pm 100\text{PPM}/^\circ\text{C}$ 0805,1206,1210,2010,1812,2512 $0.01\Omega \leq R \leq 0.015\Omega$: $\pm 1500\text{PPM}/^\circ\text{C}$ $0.015\Omega < R \leq 0.03\Omega$: $\pm 1000\text{PPM}/^\circ\text{C}$ $0.03\Omega < R < 1\Omega$: $\pm 800\text{PPM}/^\circ\text{C}$ $1\Omega \leq R \leq 10\Omega$: $\pm 400\text{PPM}/^\circ\text{C}$ $> 10\Omega$: $\pm 100\text{PPM}/^\circ\text{C}$	4.8 Natural resistance changes per temp. Degree centigrade $\frac{R_2 - R_1}{R_1(T_2 - T_1)} \times 10^6 \text{ (PPM}/^\circ\text{C)}$ R ₁ : resistance value at room temp. (T ₁) R ₂ : resistance value at room temp. +100°C (T ₂) Test pattern: room temp. (T ₁), room temp. +100°C (T ₂)						
◎ *Short-time overload	<table border="1"> <tr> <td>$\pm 0.5\%, \pm 1\%$</td> <td>$\pm(1\% + 0.1\Omega)$ Max.</td> </tr> <tr> <td>$\pm 2\%, \pm 5\%$</td> <td>$\pm(2\% + 0.1\Omega)$ Max.</td> </tr> <tr> <td>01005</td> <td>$\pm(2\% + 0.1\Omega)$ Max</td> </tr> </table>	$\pm 0.5\%, \pm 1\%$	$\pm(1\% + 0.1\Omega)$ Max.	$\pm 2\%, \pm 5\%$	$\pm(2\% + 0.1\Omega)$ Max.	01005	$\pm(2\% + 0.1\Omega)$ Max	4.13 Permanent resistance change after the application of a potential of 2.5 times RCWV or Max. Overload Voltage whichever less for 5 seconds..
$\pm 0.5\%, \pm 1\%$	$\pm(1\% + 0.1\Omega)$ Max.							
$\pm 2\%, \pm 5\%$	$\pm(2\% + 0.1\Omega)$ Max.							
01005	$\pm(2\% + 0.1\Omega)$ Max							
* Dielectric withstanding voltage	No evidence of flashover mechanical damage, arcing or insulation breaks down.	4.7 Resistors shall be clamped in the trough of a 90°C metallic v-block and shall be tested at ac potential respectively specified in the given list of each product type for 60-70 seconds.						
◎ *Solderability	95% coverage Min. Go up tin rate bigger than half of end pole	Wave solder: Test temperature of solder: $260^\circ\text{C} \pm 5^\circ\text{C}$ dipping time in solder: 2-3 seconds. Reflow: 						

Approved	Checked	Prepared	File NO.	Edition	Date	Page
William Zhao	Ted Hsu	Chengxia Tang	YHT-01-034	1	2017/08/18	10/16

厚聲國際貿易（昆山）有限公司深圳分公司
Uniroyal Electronics Global Co.,Ltd Shenzhen Branch



ISO14001



ISO/TS16949



244546



245468



REG.-Nr.A759



CQC04001010656

◎ Temperature cycling	±0.5%,±1%	±(0.5%+0.05 Ω)Max	4.19Resistance change after continuous five cycles for duty cycle specified below: <table border="1"> <thead> <tr> <th>Step</th> <th>Temperature</th> <th>Time</th> </tr> </thead> <tbody> <tr> <td>1</td> <td>-55°C±3°C</td> <td>30 mins</td> </tr> <tr> <td>2</td> <td>Room temp.</td> <td>10 --- 15 mins</td> </tr> <tr> <td>3</td> <td>+155°C±2°C</td> <td>30 mins</td> </tr> <tr> <td>4</td> <td>Room temp.</td> <td>10 --- 15 mins</td> </tr> </tbody> </table>	Step	Temperature	Time	1	-55°C±3°C	30 mins	2	Room temp.	10 --- 15 mins	3	+155°C±2°C	30 mins	4	Room temp.	10 --- 15 mins
	Step	Temperature		Time														
	1	-55°C±3°C		30 mins														
2	Room temp.	10 --- 15 mins																
3	+155°C±2°C	30 mins																
4	Room temp.	10 --- 15 mins																
±2%,±5%	±(1.0%+0.05 Ω) Max																	
01005	±(1%+0.05 Ω) Max																	
◎ Soldering heat	Resistance change rate must be in ±(1%+0.05 Ω)		4.18 Dip the resistor into a solder bath having a temperature of 260°C±5°C and hold it for 10±1 seconds.															
Terminal bending	±(1%+0.05 Ω) Max		4.33 Twist of test board: Y/x = 3/90 mm for 60Seconds															
* Insulation resistance	1,000 MΩ or more		4.6 the measuring voltage shall be ,measured with a direct voltage of (100±15)V or a voltage equal to the dielectric withstanding voltage., and apply for 1min															
◎ Humidity (steady state)	±0.5%,±1%	±(0.5%+0.1Ω) Max.	4.24Temporary resistance change after 240 hours exposure in a humidity test chamber controlled at 40±2 °C and 90-95% relative humidity,															
	±2%,±5%	±(3.0%+0.1Ω) Max.																
	01005	±(3.0%+0.05Ω) Max.																
◎ *Load life in humidity	±0.5%,±1%	±(1%+0.1Ω)max.	7.9 Resistance change after 1,000 hours (1.5 hours "ON",0.5 hour "OFF") at RCWV in a humidity chamber controlled at 40°C±2°C and 90 to 95% relative humidity.															
	±2%,±5%	±(3%+0.1Ω)Max.																
	01005	±(3.0%+0.05Ω) Max.																
	* <50mΩ		Apply to rated current for 0 Ω															
◎ *Load life	±0.5%,±1%	±(1%+0.1Ω)Max.	4.25.1 Permanent resistance change after 1,000 hours operating at RCWV with duty cycle 1.5 hours "ON", 0.5 hour "OFF" at 70°C±2°C ambient.															
	±2%,±5%	±(3%+0.1Ω)Max																
	01005	±(3.0%+0.05Ω) Max.																
	* <50mΩ		Apply to rated current for 0 Ω															
The resistors of 0 Ω only can do the characteristic noted of *																		
The resistors of 01005 & 0201 only can do the characteristic noted of ◎																		

Approved	Checked	Prepared	File NO.	Edition	Date	Page
William Zhao	Ted Hsu	Chengxia Tang	YHT-01-034	1	2017/08/18	11/16



7.0 Explanation of Part No. System:

The standard Part No. includes 14 digits with the following explanation:

7.1 1st ~4th digits

This is to indicate the Chip Resistor.

Example: 01005,0201,0402,0603,0805,1206,1210,2010,1812,2512

7.2 5th ~6th digits:

7.2.1 This is to indicate the wattage or power rating. To dieting the size and the numbers,

The following codes are used; and please refer to the following chart for detail:

W=Normal Size; 1" ~ "G" to denotes "1" ~ "16" as Hexadecimal:

1/16W~1W:

Wattage	1/32	3/4W	1/2	1/3	1/4	1/8	1/10	1/16	1/20W	1
Normal Size	WH	07	W2	W3	W4	W8	WA	WG	WM	1W

7.2.2 For power rating less or equal to 1 watt, the 5th digit will be the letters W to represent the size required & the 6th digit will be a number or a letter code.

Example: WA=1/10W; W4=1/4W

7.3 The 7th digit is to denote the Resistance Tolerance. The following letter code is to be used for indicating the standard Resistance Tolerance.

D=±0.5% F=±1% G=±2% J=±5% K= ±10%

7.4 The 8th to 11th digits is to denote the Resistance Value.

7.4.1 For the standard resistance values of 5%&10% series, the 8th digit is "0", the 9th & 10th digits are to denote the significant figures of the resistance and the 11th digit is the number of zeros following;

For the standard resistance values of ≤2% series in, the 8th digit to the 10th digits is to denote the significant figures of the resistance and the 11th digit is the zeros following.

7.4.2 The following number s and the letter codes are to be used to indicate the number of zeros in the 11th digit:

0=10⁰ 1=10¹ 2=10² 3=10³ 4=10⁴ 5=10⁵ 6=10⁶
 J=10⁻¹ K=10⁻² L=10⁻³ M=10⁻⁴ N=10⁻⁵ P=10⁻⁶

Approved	Checked	Prepared	File NO.	Edition	Date	Page
William Zhao	Ted Hsu	Chengxia Tang	YHT-01-034	1	2017/08/18	12/16



ISO14001



ISO/TS16949



244546



245468



REG.-Nr.A759



GQC04001010656

7.4.3 The 12th, 13th & 14th digits.

The 12th digit is to denote the Packaging Type with the following codes:

C=Bulk in (Chip Product)

T=Tape/Reel

7.4.4 The 13th digit is normally to indicate the Packing Quantity of Tape/Reel packaging types. The following letter code is to be used for some packing quantities:

4=4000pcs 5=5000pcs C=10000pcs D=20000pcs E=15000pcs

Chip Product: BD=B/B-20000pcs

TC=T/R-10000pcs

7.4.5 For some items, the 14th digit alone can use to denote special features of additional information with the following codes:

E=For “Environmental Protection, Lead Free type” of Chip.

8.0 Ordering Procedure: (Example: 0805 1/8W ±5% 10KΩ T/R-5000)

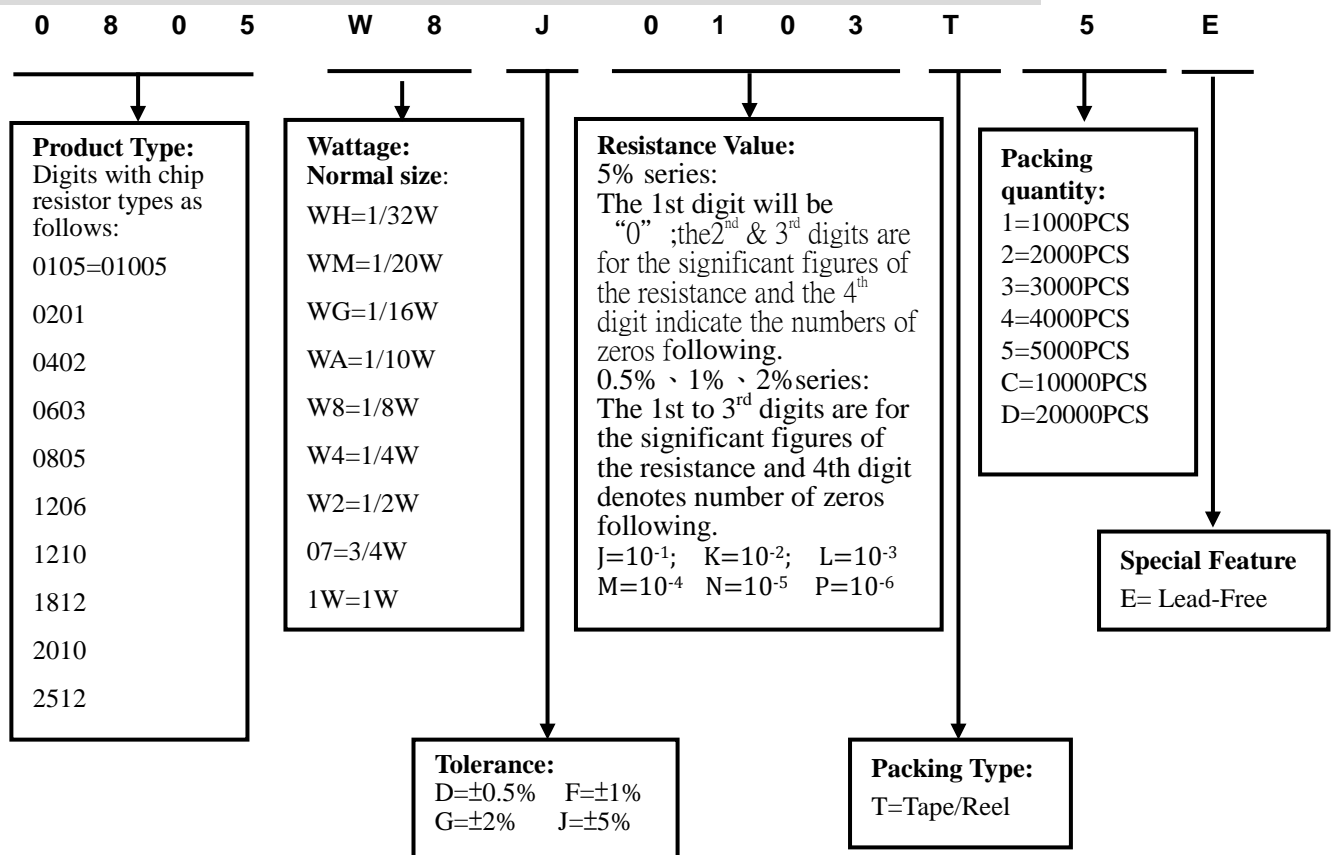

Approved	Checked	Prepared	File NO.	Edition	Date	Page
William Zhao	Ted Hsu	Chengxia Tang	YHT-01-034	1	2017/08/18	13/16



ISO14001 ISO/TS16949 244546 245468 REG.-Nr.A759 CQC04001010050

9.0 Packaging:

9.1 Tapping Dimension:

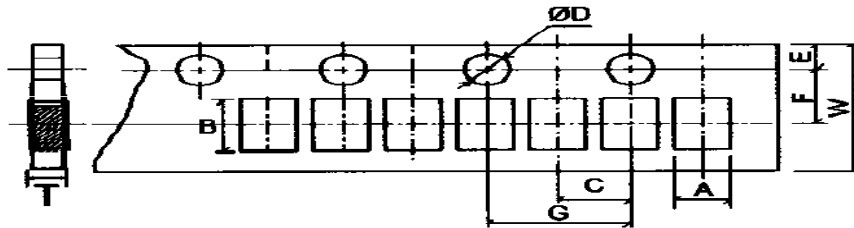

Unit: mm

Type	A	B	C±0.05	$\begin{matrix} +0.1 \\ \Phi D \\ -0 \end{matrix}$	E±0.1	F±0.05	G±0.1	W±0.2	T±0.1
01005	0.24±0.05	0.45±0.05	2.00	1.50	1.75	3.50	4.00	8.00	0.40±0.1
0201	0.40±0.05	0.70±0.05	2.00	1.50	1.75	3.50	4.00	8.00	0.42±0.1
0402	0.65±0.10	1.20±0.10	2.00	1.50	1.75	3.50	4.00	8.00	0.42±0.05

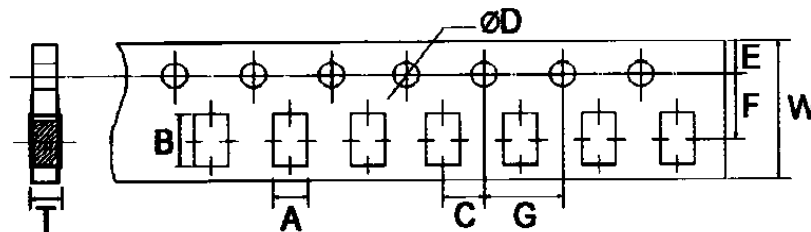

Unit: mm

Type	A ±0.2	B ±0.2	C±0.05	$\begin{matrix} +0.1 \\ \Phi D \\ -0 \end{matrix}$	E±0.1	F±0.05	G±0.1	W±0.2	T±0.1
0603	1.10	1.90	2.00	1.50	1.75	3.50	4.00	8.00	0.67
0805	1.65	2.40	2.00	1.50	1.75	3.50	4.00	8.00	0.81
1206	2.00	3.60	2.00	1.50	1.75	3.50	4.00	8.00	0.81
1210	2.80	3.50	2.00	1.50	1.75	3.50	4.00	8.00	0.75

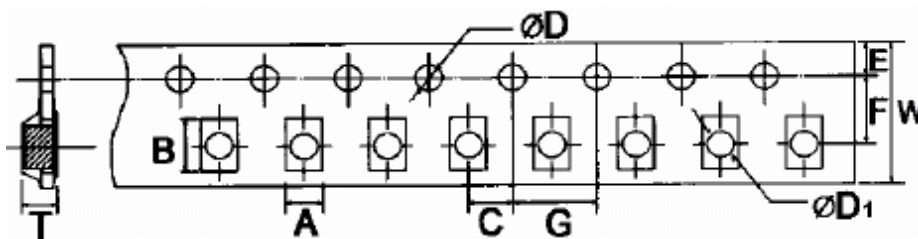

Approved	Checked	Prepared	File NO.	Edition	Date	Page
William Zhao	Ted Hsu	Chengxia Tang	YHT-01-034	1	2017/08/18	14/16



ISO14001



ISO/TS16949



244546



245468



REG.-Nr.A759



GQC04001010656

Unit: mm

Type	A±0.2	B±0.2	C±0.05	+ 0.1 φD - 0	+0.25 φD1 -0	E±0.1	F±0.05	G±0.1	W±0.2	T±0.1
2010	2.90	5.60	2.00	1.50	1.50	1.75	5.50	4.00	12.00	1.00
1812	3.50	4.80	2.00	1.50	1.50	1.75	5.50	4.00	12.00	1.00
2512	3.50	6.70	2.00	1.50	1.50	1.75	5.50	4.00	12.00	1.00

9.2 Dimension:

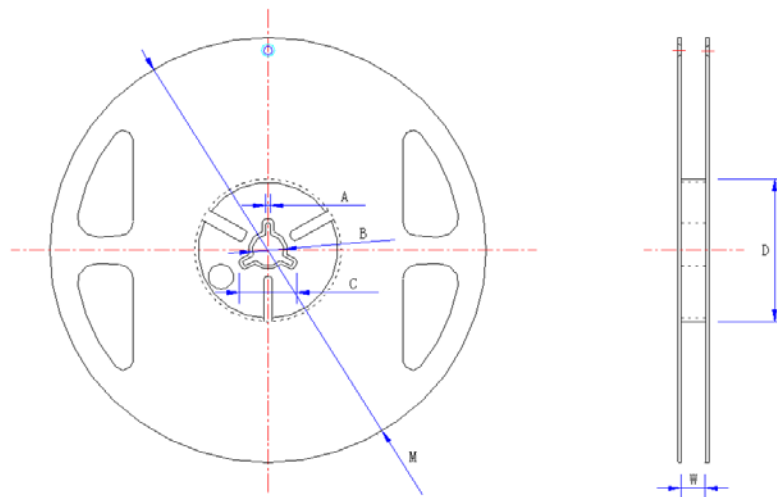

Unit: mm

Type	Taping	Qty/Reel	A±0.5	B±0.5	C±0.5	D±1	M±2	W±1
01005	Paper	20,000pcs	2.0	13.0	21.0	60.0	178.0	10.0
0201	Paper	10,000pcs	2.0	13.0	21.0	60.0	178.0	10.0
0402	Paper	10,000pcs	2.0	13.0	21.0	60.0	178.0	10.0
0603	Paper	5,000pcs	2.0	13.0	21.0	60.0	178.0	10.0
0805	Paper	5,000pcs	2.0	13.0	21.0	60.0	178.0	10.0
1206	Paper	5,000pcs	2.0	13.0	21.0	60.0	178.0	10.0
1210	Paper	5,000pcs	2.0	13.0	21.0	60.0	178.0	10.0
2010	Embossed	4,000pcs	2.0	13.0	21.0	60.0	178.0	13.8
1812	Embossed	4,000pcs	2.0	13.0	21.0	60.0	178.0	13.8
2512	Embossed	4,000pcs	2.0	13.0	21.0	60.0	178.0	13.8

Approved	Checked	Prepared	File NO.	Edition	Date	Page
William Zhao	Ted Hsu	Chengxia Tang	YHT-01-034	1	2017/08/18	15/16



ISO14001



ISO/TS16949



244546



245468



REG.-Nr.A759



CQC04001010658

10.0: Note Matter:

10.1 UNIOHM recommend the storage condition temperature: 15°C~35°C, humidity :25%~75%.

(Put condition for individual product).

Even under UNIOHM recommended storage condition, solderability of products over 1 year old.

(Put condition for each product) may be degraded.

10.2 Store / transport cartons in the correct direction, which is indicated on a carton as a symbol.

Otherwise bent leads may occur due to excessive stress applied when dropping of a carton.

10.3 Product performance and soldered connections may deteriorate if the products are stored in the following places:

a. Storage in high Electrostatic.

b. Storage in direct sunshine 、rain and snow or condensation.

c. Where the products are exposed to sea winds or corrosive gases, including Cl₂, H₂S₃ NH₃, SO₂, NO₂.

10.4 The products are used in circuit board thickness greater than 1.6mm. If customers use less than the thickness of the circuit board that you should confirm with the company, in order to recommend a more suitable product.

Approved	Checked	Prepared	File NO.	Edition	Date	Page
William Zhao	Ted Hsu	Chengxia Tang	YHT-01-034	1	2017/08/18	16/16

X-ON Electronics

Largest Supplier of Electrical and Electronic Components

Click to view similar products for [Thick Film Resistors](#) category:

Click to view products by [Uniroyal](#) manufacturer:

Other Similar products are found below :

[MCR03EZPFX3162](#) [MCR004YZPJ332](#) [201007J022KT4E](#) [201007F1653T4E](#) [201007F6652T4E](#) [0603WAF137KT5E](#) [RTT204702FTE](#)
[RTT203000FTE](#) [RTT2056R0FTE](#) [CR2010F470KE04Z](#) [RTT018451FTH](#) [RTT021802DTH](#) [0402WGF510LTCE](#) [0201WMJ0200TEE](#)
[TR0603B26K7P0550Z](#) [0201WMF5102TEE](#) [1210W2J047KT5E](#) [YLR12-2-4F-W](#) [HOT\(0.25x1.3\)-3.2-0R-I](#) [HOT\(0.4x1.5\)-5.2-0R-I](#)
[HoT\(0.45x1.5\)-8.2-0R-I](#) [0201WMF1103TEE](#) [0201WMF7152TEE](#) [1210W2J0124T5E](#) [201007J010LT4E](#) [201007J0360T4E](#) [201007J0430T4E](#)
[0805W8F931KT5E](#) [1206W4F5231T5E](#) [1210W2J0620T5E](#) [201007J0822T4E](#) [0201WMF1005TCE](#) [0201WMF1212TCE](#) [0201WMF1373TCE](#)
[0201WMF1400TCE](#) [0201WMF2000TEE](#) [0201WMF2001TCE](#) [0201WMF226JTCE](#) [0201WMF2672TCE](#) [0201WMF2803TCE](#)
[0201WMF357JTCE](#) [0201WMF3743TCE](#) [0201WMF430JTCE](#) [0201WMF4990TCE](#) [0201WMF5104TCE](#) [0201WMF510JTEE](#)
[0201WMF5110TCE](#) [0201WMF6652TEE](#) [0201WMF6812TCE](#) [0201WMF8200TCE](#)