



ISO14001



ISO/TS16949



244546



245468



REG.-Nr.A759



CQC04001610658



Specification for Approval

Customer : 深圳市立創電子商務有限公司

Product Name : **Chip Resistor Array**

Part Name : **Resistor Array Series $\pm 1\%$, $\pm 5\%$ & 0Ω**

Part No. : ******WG*****T*E, 4DP3WA*****T*E**
2F01WM***T*E, 4F01WM*****T*E**

Building 8, Jiuwei Industrial Zone, Xixiang Town, Bao'An District ,Shenzhen, Guangdong, China
Guangdong Province, China

TEL: 0755-27484508

FAX: 0755-27484308

Approved	Checked	Prepared	File NO.	Edition	Date	Page
William Zhao	Ted Hsu	Chengxia Tang	JLC-01-015	1	2017/06/12	1/14



ISO14001



ISO/TS16949



244546



245468



REG.-Nr.A759



CQC034001610658

Contents

Introduction	Page
1.0 Scope	4
2.0 Type Designation.....	4
3.0 Ratings & Dimension	4~6
4.0 Structure.....	6
5.0 Marking	7~8
6.0 Power rating.....	9
7.0 Performance Specification	9~10
8.0 Explanation of Part No. System	11
9.0 Ordering Procedure	12
10.0 Standard Packing	12~13
11.0 Precaution for storage/Transportation.....	14

Approved	Checked	Prepared	File NO.	Edition	Date	Page
William Zhao	Ted Hsu	Chengxia Tang	JLC-01-015	1	2017/06/12	2/14

厚聲國際貿易（昆山）有限公司深圳分公司
Uniroyal Electronics Global Co.,Ltd Shenzhen Branch



ISO14001



ISO/TS16949



244546



245468



REG.-Nr.A759



CQC034001610058

File Name: Resistor Array Series $\pm 1\%$ 、 $\pm 5\%$ & 0Ω		Date	2017/06/12	Edition No.	1
Amendment Record				Signature	
Edition	Prescription of amendment	Amend Page	Amend Date	Amended by	Checked by

Approved	Checked	Prepared	File NO.	Edition	Date	Page
William Zhao	Ted Hsu	Chengxia Tang	JLC-01-015	1	2017/06/12	3/14



1.0 Scope:

This sheet is the statement of the Chip Resistor Array- Concave Terminal specification that UNIOHM'S productions can meet.

2.0 Type Designation:

The type designation shall be in the following from:

Example:

Type	Power rating	Resistance tolerance	Nominal resistance
4C02	1/16W	J	100Ω

3.0 Ratings & Dimension:

3.1 Equivalent Circuit Diagram:

2D02/2D03 /2C02/2F01	4D02/4D03 /4C02/4C03/4F01	16P8
 <p>R1=R2</p>	 <p>R1=R2=R3=R4</p>	 <p>R1=R2=R3=R4=R5=R6=R7=R8</p>

3.2 Dimensions in mm:

Convex Terminal type		
2D02/2D03	4D02/4D03	16P8
		

Approved	Checked	Prepared	File NO.	Edition	Date	Page
William Zhao	Ted Hsu	Chengxia Tang	JLC-01-015	1	2017/06/12	4/14



ISO14001



ISO/TS16949



244546



245468



REG.-Nr.A759



CQC34001610658

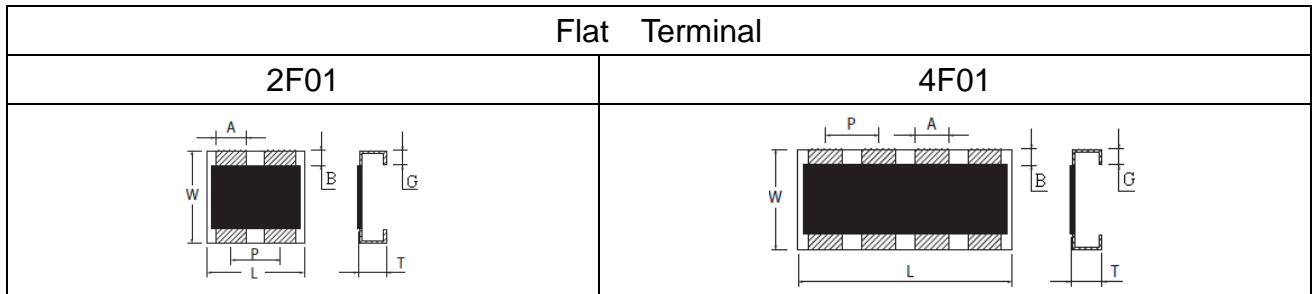
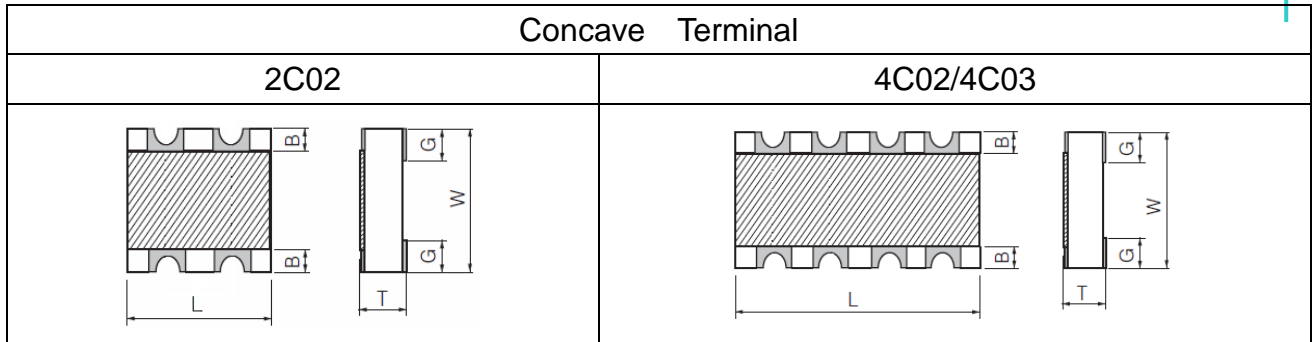

Type	Dimensions (mm)							
	L	W	T	A1	A2	B	P	G
2D02	1.00±0.10	1.00±0.10	0.35±0.10	0.33±0.10	/	0.15±0.05	0.65±0.05	0.25±0.10
4D02	2.00±0.10	1.00±0.10	0.45±0.10	0.40±0.05	0.30±0.05	0.20±0.15	0.50±0.05	0.30±0.15
2D03	1.60±0.15	1.60±0.15	0.50±0.10	0.60±0.15	/	0.30±0.10	0.80±0.05	0.25±0.10
4D03	3.20±0.20	1.60±0.20	0.50±0.10	0.65±0.15	0.50±0.15	0.30±0.15	0.80±0.10	0.30±0.15
16P8	4.00±0.20	1.60±0.15	0.45±0.10	0.45±0.05	0.30±0.05	0.30±0.15	0.50±0.05	0.40±0.15
2C02	1.00±0.10	1.00±0.10	0.35±0.10	/	/	0.15±0.10	/	0.30±0.10
4C02	2.00±0.10	1.00±0.10	0.45±0.10	/	/	0.15±0.10	/	0.30±0.10
4C03	3.20±0.20	1.60±0.20	0.60±0.10	/	/	0.30±0.20	/	0.40±0.10
2F01	0.80±0.10	0.60±0.10	0.35±0.10	0.30±0.10	/	0.15±0.10	0.50±0.05	0.15±0.10
4F01	1.40±0.10	0.60±0.10	0.35±0.10	0.20±0.10	/	0.15±0.10	0.40±0.05	0.15±0.10

Approved	Checked	Prepared	File NO.	Edition	Date	Page
William Zhao	Ted Hsu	Chengxia Tang	JLC-01-015	1	2017/06/12	5/14



3.3 Ratings:

Type	Rated power 70°C	Max Working Voltage	Max Overload Voltage	Dielectric Withstanding Voltage	Resistance Range $\pm 5\% \pm 1\%$	Temperature Coefficient PPM/°C	Operating Temperature	Resistance Value of Jumper	Rated Current of Jumper
2D02	1/16W	50V	100V	100V	10 Ω ~1M Ω	± 200	-55°C~+155°C	<50m Ω	1A
4D02	1/16W	50V	100V	100V	10 Ω ~1M Ω	± 200			
2D03	1/16W	50V	100V	100V	10 Ω ~1M Ω	± 200			
4D03	1/16W	50V	100V	300V	1 Ω ~1M Ω	$\geq 10 \Omega: \pm 200$ $< 10 \Omega: \pm 400$			
4DP3	1/10W	50V	100V	300V	1 Ω ~1M Ω	$\geq 10 \Omega: \pm 200$ $< 10 \Omega: \pm 400$			
16P8	1/16W	50V	100V	300V	1 Ω ~1M Ω	$\geq 10 \Omega: \pm 200$ $< 10 \Omega: \pm 400$			
2C02	1/16W	50V	100V	100V	10 Ω ~1M Ω	± 200			
4C02	1/16W	50V	100V	100V	10 Ω ~1M Ω	± 200			
4C03	1/16W	50V	100V	300V	1 Ω ~1M Ω	$\geq 10 \Omega: \pm 200$ $< 10 \Omega: \pm 400$			
2F01	1/20W	12.5V	25V	/	10 Ω ~1M Ω	± 200	-55°C~+125°C	<50m Ω	1A
4F01	1/20W	12.5V	25V	/	10 Ω ~1M Ω	± 200			

4.0 Structure:



- 1: High purity alumina substrate
- 2: Protective covering
- 3: Resistive covering
- 4: Termination (inner) Ag/Pd
- 5: Termination (between) Ni plating
- 6: Termination (outer) Sn plating

Approved	Checked	Prepared	File NO.	Edition	Date	Page
William Zhao	Ted Hsu	Chengxia Tang	JLC-01-015	1	2017/06/12	6/14



ISO14001



ISO/TS16949



244546



245468



REG.-Nr.A759



CQC34001610658

5.0 Marking:

5.1 Normal for 2C02 & 4C02 size, no marking on the body, 0Ω resistors is no marking too.

Normal of 4C03 size, the marking as following:

EXAMPLE:

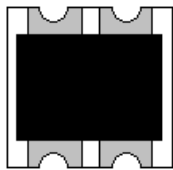

2C02



4C02



4C03

5.2 ±5% Tolerance of 4C03 size: the first two digits are significant figures of resistance and the third denotes number of zeros following.

EXAMPLE:



33000 → 33KΩ

5.3 ±1% Tolerance of 4C03, size: first three digits are significant figures of resistance and the fourth denotes number of zeros following.

EXAMPLE:



2701 → 2.7KΩ

5.4 Normal for 2D02 sizes, no marking on the body. 0Ω resistors is no marking too

EXAMPLE:



Approved	Checked	Prepared	File NO.	Edition	Date	Page
William Zhao	Ted Hsu	Chengxia Tang	JLC-01-015	1	2017/06/12	7/14



5.5 $\pm 5\%$ Tolerance of 4D02, 2D03, 4D03, 4DP3 and 16P8 size: the first two digits are significant figures of resistance and the third denotes number of zeros following

EXAMPLE:
2D03

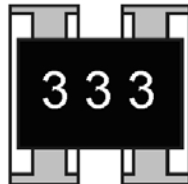

33000 \rightarrow 33K Ω

4D02, 4D03, 4DP3

16P8



33000 \rightarrow 33K Ω

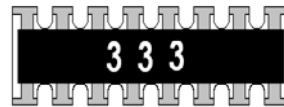

33000 \rightarrow 33K Ω

5.6 $\pm 1\%$ Tolerance of 4D02, 2D03, 4D03, 4DP3 and 16P8 size: first three digits are significant figures of resistance and the fourth denotes number of zeros following

EXAMPLE:
2D03

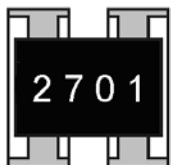

2701 \rightarrow 2.7K Ω

4D02, 4D03

16P8

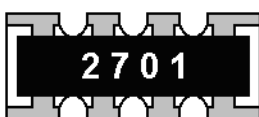

2701 \rightarrow 2.7K Ω

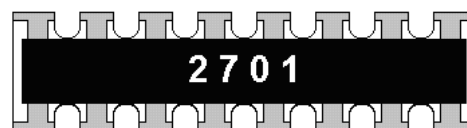

2701 \rightarrow 2.7K Ω

5.7 0 Ω Normal of 4D02, 4D03, 16P8 size, the marking as following:

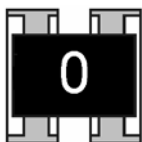

2D03

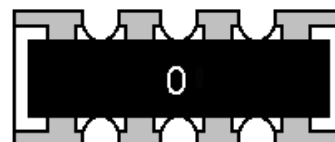

4D02, 4D03, 4DP3

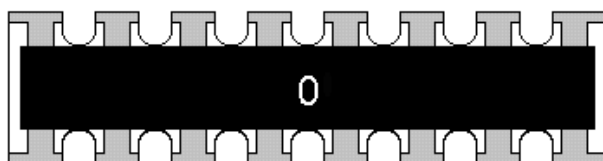

16P8

Approved	Checked	Prepared	File NO.	Edition	Date	Page
William Zhao	Ted Hsu	Chengxia Tang	JLC-01-015	1	2017/06/12	8/14



5.8 Normal for 2F01, 4F01 sizes, no marking on the body. 0Ω resistors is no marking too



6.0 Power Rating:

Resistors shall have a power rating based on continuous load operation at an ambient temperature from -55°C to 70°C. For temperature in excess of 70°C, the load shall be derate as shown in figure 1



6.1 Voltage rating:

Resistors shall have a rated direct-current (DC) continuous working Voltage or an approximate sine-wave root-mean-square (RMS) alternating-current (AC) continuous working voltage at commercial-line frequency and waveform corresponding to the power rating, as determined from the following formula:

$$RCWV = \sqrt{P \times R}$$

Where: RCWV commercial-line frequency and waveform (Volt.)

P = power rating (WATT.)

R = nominal resistance (OHM)

The overload voltage is 2.5 times RCWV or Max. Overload voltage whichever is less.

In no case shall the rated DC or RMS AC continuous working voltage be greater than the applicable maximum value.

Approved	Checked	Prepared	File NO.	Edition	Date	Page
William Zhao	Ted Hsu	Chengxia Tang	JLC-01-015	1	2017/06/12	9/14



7.0 Performance Specification:

Characteristic	Limits	Test Method (JIS-C-5201&5202)
Temperature Coefficient	Reference 3.3	4.8 natural resistance changes per temp. Degree centigrade $\frac{R_2-R_1}{R_1(T_2-T_1)} \times 10^6 \text{ (PPM/}^\circ\text{C)}$ R ₁ : resistance value at room temp. (T ₁) R ₂ : resistance value at room temp. +100°C (T ₂) Test pattern: room temp. (T ₁), room temp. +100°C (T ₂)
*Short-time overload	±(2%+0.1 Ω) MAX 2F01: 1%: ±1%+0.05 Ω 5%: ±2%+0.05 Ω * ΔR<50mΩ	4.13 Permanent resistance change after the application of 2.5 times RCWV for 5 seconds. Apply max overload current for 0 Ω
* Insulation resistance	≥1,000 MΩ	4.6 the measuring voltage shall be ,measured with a direct voltage of (100±15)v or a voltage equal to the dielectric withstanding voltage., and apply for 1min
Terminal bending	±(1%+0.05 Ω) Max	4.33 Twist of test board: Y/x = 3/90 mm for 60Seconds
* Dielectric withstanding voltage	No evidence of flashover mechanical damage, arcing or insulation breaks down.	4.7 Resistors shall be clamped in the trough of a 90° metallic v-block and shall be tested at ac potential respectively specified in the given list of each product type for 60-70 seconds.
Soldering heat	Resistance change rate is: ±(1%+0.05 Ω) Max	4.18 Dip the resistor into a solder bath having a temperature of 260°C±5°C and hold it for 10±1 seconds.
*Solderability	95% coverage Min. Go up tin rate bigger than half of end pole	Wave solder: Test temperature of solder: 245°C±3°C dipping time in solder: 2-3 seconds. Reflow: 

Approved	Checked	Prepared	File NO.	Edition	Date	Page
William Zhao	Ted Hsu	Chengxia Tang	JLC-01-015	1	2017/06/12	10/14



Temperature cycling	$\Delta R/R \leq \pm(1.0\% + 0.05\Omega)$ 2F01: 1%: $\pm 0.5\% + 0.05\Omega$ 5%: $\pm 1\% + 0.05\Omega$	4.19 Resistance change after continuous five cycles for duty cycle specified below:													
		<table border="1"> <thead> <tr> <th>STEP</th> <th>TEMPERATURE</th> <th>TIME</th> </tr> </thead> <tbody> <tr> <td>1</td> <td>-55°C±3°C</td> <td>30 MINS</td> </tr> <tr> <td>2</td> <td>ROOM TEMP.</td> <td>10 --- 15 MINS</td> </tr> <tr> <td>3</td> <td>+155°C±2°C</td> <td>30 MINS</td> </tr> <tr> <td>4</td> <td>ROOM TEMP.</td> <td>10 --- 15 MINS</td> </tr> </tbody> </table> *Step1-4 Continuous 5 cycles	STEP	TEMPERATURE	TIME	1	-55°C±3°C	30 MINS	2	ROOM TEMP.	10 --- 15 MINS	3	+155°C±2°C	30 MINS	4
STEP	TEMPERATURE	TIME													
1	-55°C±3°C	30 MINS													
2	ROOM TEMP.	10 --- 15 MINS													
3	+155°C±2°C	30 MINS													
4	ROOM TEMP.	10 --- 15 MINS													
*Load life in humidity	$\pm(3.0\% \pm 0.1\Omega)$ Max. 2F01: 1%: $\pm 2\% + 0.1\Omega$ 5%: $\pm 3\% \pm 0.1\Omega$	7.9 Resistance change after 1,000 hours (1.5 hours "ON", 0.5 hour "OFF") at RCWV in a humidity chamber controlled at 40°C±2°C and 90 to 95% relative humidity.													
		* $\Delta R < 50m\Omega$ Apply to rated current for 0Ω													
*Load life	$\pm(3.0\% \pm 0.1\Omega)$ Max. 2F01: 1%: $\pm 2\% + 0.1\Omega$ 5%: $\pm 3\% \pm 0.1\Omega$	4.25.1 Permanent resistance change after 1,000 hours operating at RCWV with duty cycle 1.5 hours "ON", 0.5 hour "OFF", at 70°C±2°C ambient.													
		* $\Delta R < 50m\Omega$ Apply to rated current for 0Ω													
The resistors of 0Ω only can do the characteristic noted of *															

8.0 Explanation of Part No. System:

The standard Part No. includes 14 digits with the following explanation:

8.1 This is to indicate the Chip Array Resistor size.

Example: 2D02, 4D02, 2D03, 4D03, 4DP3, 16P8, 2C02, 4C02, 4C03, 2F01, 4F01

8.2 5th~6th digits:

8.2.1 This is to indicate the wattage or power rating. To dieting the size and the numbers,

The following codes are used; and please refer to the following chart for detail:

W=Normal Size; "1" ~ "G" to denotes "1" ~ "16" as Hexadecimal:

1/16W~1W:

Wattage	1/2	1/8	1/10	1/16
Normal Size	W2	W8	WA	WG

8.2.2 For power rating less than 1 watt, the 5th digit will be the letters W to represent the size required & the 6th digit will be a number or a letter code.

Example: WG=1/16W

8.3 The 7th digit is to denote the Resistance Tolerance. The following letter code is to be used for indicating the standard Resistance Tolerance.

F=±1% G=±2% J=±5% K= ±10%

Approved	Checked	Prepared	File NO.	Edition	Date	Page
William Zhao	Ted Hsu	Chengxia Tang	JLC-01-015	1	2017/06/12	11/14



ISO14001



ISO/TS16949



244546



245468



REG.-Nr.A759



CQC04001610658

10.0 Packaging:

10.1 Tapping Dimension:



Unit: mm

TYPE	A ±0.2	B ±0.2	C±0.05	ΦD $\begin{matrix} +0.1 \\ -0 \end{matrix}$	E±0.1	F±0.05	G±0.1	W±0.2	T±0.1
2D02,2C02	1.20	1.20	2.00	1.50	1.75	3.50	4.00	8.00	0.45
4D02,4C02	1.20	2.20	2.00	1.50	1.75	3.50	4.00	8.00	0.70
2F01	0.79	1.00	2.00	1.50	1.75	3.50	4.00	8.00	0.50
4F01	0.90	1.70	2.00	1.50	1.75	3.50	4.00	8.00	0.50



Unit: mm

TYPE	A ±0.2	B ±0.2	C±0.05	ΦD $\begin{matrix} +0.1 \\ -0 \end{matrix}$	E±0.1	F±0.05	G±0.1	W±0.2	T±0.1
4D03,4C03	2.00	3.60	2.00	1.50	1.75	3.50	4.00	8.00	0.83
2D03	1.90	1.90	2.00	1.50	1.75	3.50	4.00	8.00	0.83
16P8	1.80	4.30	2.00	1.50	1.75	5.50	4.00	12.00	0.75

Approved	Checked	Prepared	File NO.	Edition	Date	Page
William Zhao	Ted Hsu	Chengxia Tang	JLC-01-015	1	2017/06/12	13/14



10.2 Dimension:



Unit: mm

TYPE	Quantity per Reel	A ± 0.5	B ± 0.5	C ± 0.5	D ± 1.0	M ± 2.0	W ± 1.0
2D02	10,000PCS	2.0	13.0	21.0	60.0	178.0	10.0
4D02	10,000PCS	2.0	13.0	21.0	60.0	178.0	10.0
2D03	5,000PCS	2.0	13.0	21.0	60.0	178.0	10.0
4D03	5,000PCS	2.0	13.0	21.0	60.0	178.0	10.0
4DP3	5,000PCS	2.0	13.0	21.0	60.0	178.0	10.0
16P8	4,000PCS	2.0	13.0	21.0	60.0	178.0	13.8
2C02	10,000PCS	2.0	13.0	21.0	60.0	178.0	10.0
4C02	10,000PCS	2.0	13.0	21.0	60.0	178.0	10.0
4C03	5,000PCS	2.0	13.0	21.0	60.0	178.0	10.0
2F01	10,000PCS	2.0	13.0	21.0	60.0	178.0	10.0
4F01	10,000PCS	2.0	13.0	21.0	60.0	178.0	10.0

11.0 Precaution for storage/Transportation:

- 11.1 UNIOHM recommend the storage condition temperature: 15°C~35°C, humidity :25%~75%.
(Put condition for individual product)
Even under UNIOHM recommended storage condition, solderability of products over 1 year old. (Put condition for each product) may be degraded.
- 11.2 Store / transport cartons in the correct direction, which is indicated on a carton as a symbol.
Otherwise bent leads may occur due to excessive stress applied when dropping of a carton.
- 11.3 Product performance and soldered connections may deteriorate if the products are stored in the following places:
- Storage in high Electrostatic
 - Storage in direct sunshine 、rain and snow or condensation
 - Where the products are exposed to sea winds or corrosive gases, including Cl₂, H₂S₃ NH₃, SO₂, NO₂.

Approved	Checked	Prepared	File NO.	Edition	Date	Page
William Zhao	Ted Hsu	Chengxia Tang	JLC-01-015	1	2017/06/12	14/14

X-ON Electronics

Largest Supplier of Electrical and Electronic Components

Click to view similar products for [Resistor Networks & Arrays](#) category:

Click to view products by [Uniroyal](#) manufacturer:

Other Similar products are found below :

[CS6600552K000B8768](#) [CSC06A0122K0GEJ](#) [CSC08A01470KGEK](#) [M8340105K1002FGD03](#) [M8340106MA010FHD03](#)
[M8340107K1471FGD03](#) [M8340108K1001FCD03](#) [M8340108K2402GGD03](#) [M8340108K3240FGD03](#) [M8340108K3242FGD03](#)
[M8340108K3322FCD03](#) [M8340108K4991FGD03](#) [M8340108K6202GGD03](#) [M8340109K2002FCD03](#) [M8340109M4701GCD03](#) [EXB-](#)
[24N121JX](#) [EXB-24N330JX](#) [EXB-24N470JX](#) [EXB-A10E102J](#) [EXB-A10E104J](#) [744C083101JTR](#) [EXB-U14360JX](#) [EXB-U18240JX](#) [EXB-](#)
[U18390JX](#) [MDP1603100KGE04](#) [PRA100I2-1KBWNW](#) [GUS-SS4-BLF-01-1002-G](#) [ACAS06S0830339P100](#) [ACAS06S0830343P100](#)
[ACAS06S0830344P100](#) [RM2012A-102/104-PBVW10](#) [RM2012A-102503-PBVW10](#) [RM2012A-502104-PBVW10](#) [RM3216B-102302-](#)
[PBVW10](#) [L091S102LF](#) [ACAS06S0830341P100](#) [ACAS06S0830342P100](#) [ACAS06S0830345P100](#) [EXB-14V300JX](#) [EXB-U14220JX](#) [EXB-](#)
[U14470JX](#) [EXB-U18330JX](#) [EXB-V4N100JV](#) [EXB-V8V220GV](#) [PRA100I2-10KBWN](#) [PRA100I4-10KBWN](#) [CSC09A014K70JEK](#)
[M8340102M4701JAD04](#) [M8340105K1002GGD03](#) [M8340105M1001JCD03](#)