



**UNI-ROYAL**  
厚聲集團

# DATA SHEET

**Product Name** Anti-Surge Thick Film Chip Resistors

---

**Part Name** AS Series

## **Uniroyal Electronics Global Co., Ltd.**

88#, Longteng Road, Economic & Technical Development Zone, Kunshan, Jiangsu, China

Tel +86 512 5763 1411 / 22 /33

Email [marketing@uni-royal.cn](mailto:marketing@uni-royal.cn)

Manufacture Plant Uniroyal Electronics Industry Co., Ltd.

Aeon Technology Corporation

Royal Electronic Factory (Thailand) Co., Ltd.

Royal Technology (Thailand) Co., Ltd.

## 1. Scope

- 1.1 This datasheet is the characteristics of Anti-Surge Thick Film Chip Resistors manufactured by UNI-ROYAL.
- 1.2 Superior Anti-surge Voltage performance
- 1.3 Suitable for both wave& re-flow soldering
- 1.4 Application AV adapters, LCD back-light camera strobe etc.

## 2. Part No. System

Part No. includes 14 codes shown as below:

2.1 1<sup>st</sup>~4<sup>th</sup> codes: Part name. E.g.: AS02,AS05,AS06,AS07,AS10,AS12.

2.2 5<sup>th</sup>~6<sup>th</sup> codes: Power rating.

E.g.: W=Normal Size                      "1~G" = "1~16"

Wattage	1/32	3/4	1/2	1/3	1/4	1/8	1/10	1/16	1/20	1
Normal Size	WH	07	W2	W3	W4	W8	WA	WG	WM	1W

If power rating is equal or lower than 1 watt, 5<sup>th</sup> code would be "W" and 6<sup>th</sup> code would be a number or letter.

E.g.: WA=1/10W                      W4=1/4W

2.3 7<sup>th</sup> code: Tolerance. E.g.: D=±0.5%      F=±1%                      G=±2%                      J=±5%                      K= ±10%

2.4 8<sup>th</sup>~11<sup>th</sup> codes: Resistance Value.

2.4.1 If value belongs to standard value of E-24 series, the 8<sup>th</sup> code is zero, 9<sup>th</sup>~10<sup>th</sup> codes are the significant figures of resistance value, and the 11<sup>th</sup> code is the power of ten.

2.4.2 If value belongs to standard value of E-96 series, the 8<sup>th</sup>~10<sup>th</sup> codes are the significant figures of resistance value, and the 11<sup>th</sup> code is the power of ten.

2.4.3 11<sup>th</sup> codes listed as following:

0=10<sup>0</sup>    1=10<sup>1</sup>    2=10<sup>2</sup>    3=10<sup>3</sup>    4=10<sup>4</sup>    5=10<sup>5</sup>    6=10<sup>6</sup>    J=10<sup>-1</sup>    K=10<sup>-2</sup>    L=10<sup>-3</sup>    M=10<sup>-4</sup>

2.5 12<sup>th</sup>~14<sup>th</sup> codes.

2.5.1 12<sup>th</sup> code: Packaging Type. E.g.: C=Bulk                      T=Tape/Reel

2.5.2 13<sup>th</sup> code: Standard Packing Quantity.

4=4,000pcs    5=5,000pcs                      C=10,000pcs                      D=20,000pcs                      E=15,000pcs

Chip Product: BD=B/B-20000pcs                      TC=T/R-10000pcs

2.5.3 14<sup>th</sup> code: Special features.

E = Environmental Protection, Lead Free, or Standard type.

## 3. Ordering Procedure

(Example: AS06 0.6W ±5% 10KΩ T/R-5000)

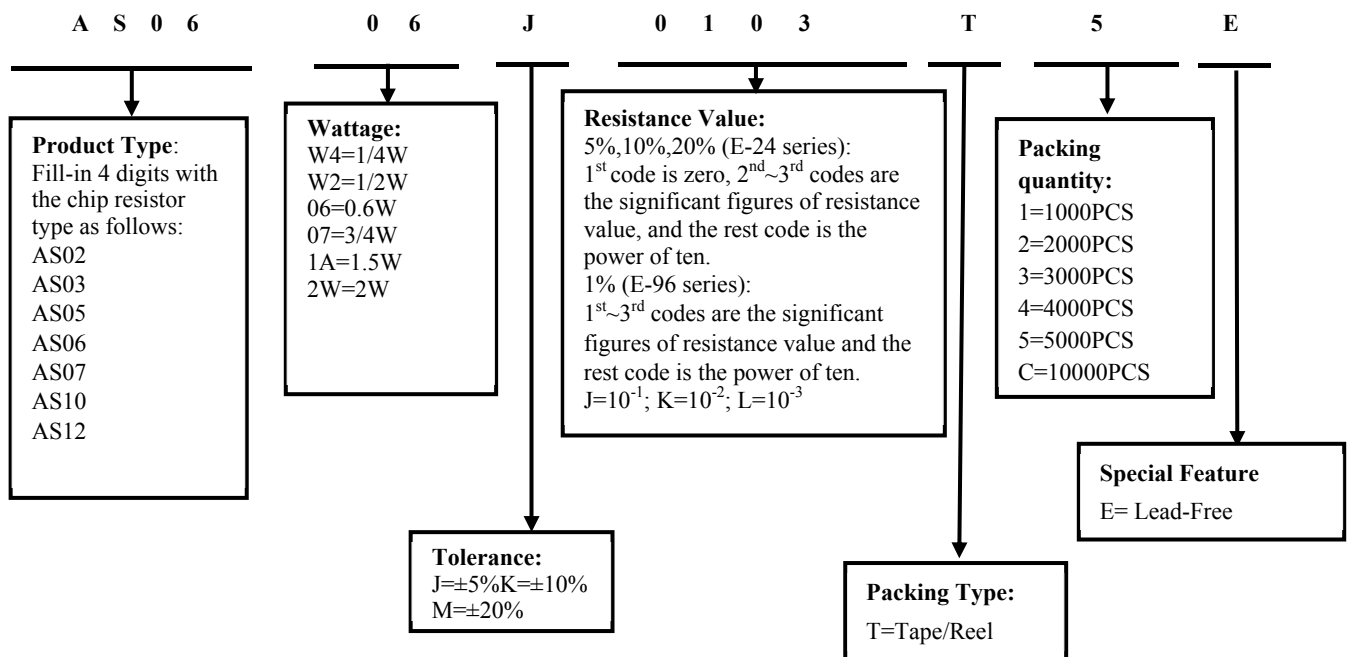

**4. Marking**

4.1 For AS02 size. Due to the very small size of the resistor's body, there is no marking on the body.



4.2 ±5%±10% ±20% tolerance products (E-24 series):  
 3 codes.

1<sup>st</sup>~2<sup>nd</sup> codes are the significant figures of resistance value, and the rest code is the power of ten.



333 → 33KΩ

4.3 ±5%±10% ±20%Tolerance:

below 10Ω Show as following, read alphabet "R" as decimal point.



2R2 → 2.2Ω

**5. Dimension**

Type	Dimension(mm)				
	L	W	H	A	B
AS02(0402)	1.00±0.10	0.50±0.05	0.35±0.05	0.20±0.10	0.25±0.10
AS03(0603)	1.60±0.10	0.80±0.10	0.45±0.10	0.30±0.20	0.30±0.20
AS05(0805)	2.00±0.15	1.25 +0.15/-0.10	0.55±0.10	0.40±0.20	0.40±0.20
AS06(1206)	3.10±0.15	1.55 +0.15/-0.10	0.55±0.10	0.45±0.20	0.45±0.20
AS07(1210)	3.10±0.10	2.60±0.20	0.55±0.10	0.50±0.25	0.50±0.20
AS10(2010)	5.00±0.10	2.50±0.20	0.55±0.10	0.60±0.25	0.50±0.20
AS12(2512)	6.35±0.10	3.20±0.20	0.55±0.10	0.60±0.25	0.50±0.20

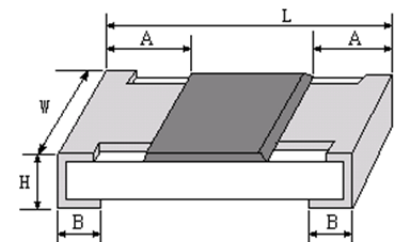

**6. Resistance Range**

Type	Power Rating at 70°C	Resistance Range		
		5%	10%	20%
AS02	1/8W	1Ω~10MΩ	1Ω~10MΩ	1Ω~10MΩ
AS03	1/4W	1Ω~10MΩ	1Ω~10MΩ	1Ω~10MΩ
AS05	1/2W	1Ω~10MΩ	1Ω~10MΩ	1Ω~10MΩ
AS06	0.6W	1Ω~10MΩ	1Ω~10MΩ	1Ω~10MΩ
AS07	3/4W	1Ω~10MΩ	1Ω~10MΩ	1Ω~10MΩ
AS10	1.5W	1Ω~10MΩ	1Ω~10MΩ	1Ω~10MΩ
AS12	2W	1Ω~10MΩ	1Ω~10MΩ	1Ω~10MΩ

**7. Ratings**

Type	Max. Working Voltage	Max. Overload Voltage	Dielectric withstanding Voltage	Operating Temperature
AS02	50V	100V	--	-55°C~155°C
AS03	75V	150V	300V	-55°C~155°C
AS05	150V	300V	500V	-55°C~155°C
AS06	200V	400V	500V	-55°C~155°C
AS07	200V	500V	500V	-55°C~155°C
AS10	400V	800V	500V	-55°C~155°C
AS12	500V	1000V	500V	-55°C~155°C

## 8. Soldering pad size recommended

Type	Dimension(mm)			
	A	B	C	D
AS03	0.8±0.05	0.65±0.05	0.8±0.05	2.4±0.05
AS05	1.0±0.1	1.0±0.1	1.4±0.1	3.0±0.1
AS06	2.0±0.1	1.1±0.1	1.8±0.1	4.2±0.1
AS07	2.0±0.1	1.1±0.1	3.0±0.1	4.2±0.1
AS10	3.6±0.1	1.4±0.1	3.0±0.1	6.4±0.1
AS12	4.9±0.1	1.35±0.1	3.7±0.1	7.6±0.1

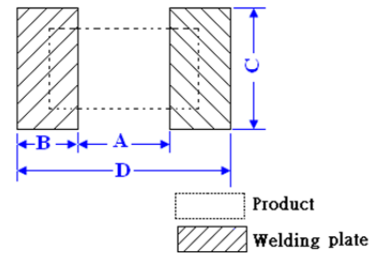

## 9. Derating Curve

Power rating will change based on continuous load at ambient temperature from -55 to 155°C.

It is constant between -55 to 70°C, and derate to zero when temperature rise from 70 to 155°C.

Voltage rating:

Resistors shall have a rated direct-current (DC) continuous working voltage or an approximate sine-wave root-mean-square (RMS) alternating-current (AC) continuous working voltage at commercial-line frequency and waveform corresponding to the power rating, as determined from the following formula:

$$RCWV = \sqrt{P \times R}$$

Remark: RCWV: Rating Continuous Working Voltage (Volt.) P: power rating (Watt) R: nominal resistance (Ω)

In no case, the rated DC or RMS AC continuous working voltage must be greater than the applicable maximum value. The overload voltage is 2.5 times RCWV or Max. Overload voltage whichever is lower.

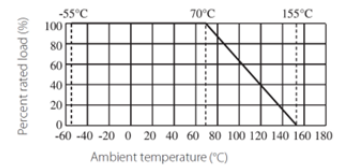

## 10. One-pulse Limiting Electric Power

Curve of Pulse Duration :

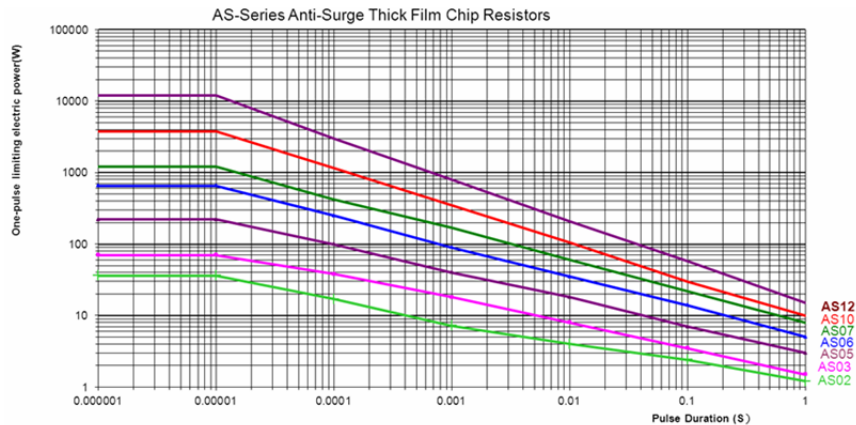

Pulse Voltage Limit :



## 11. Structure

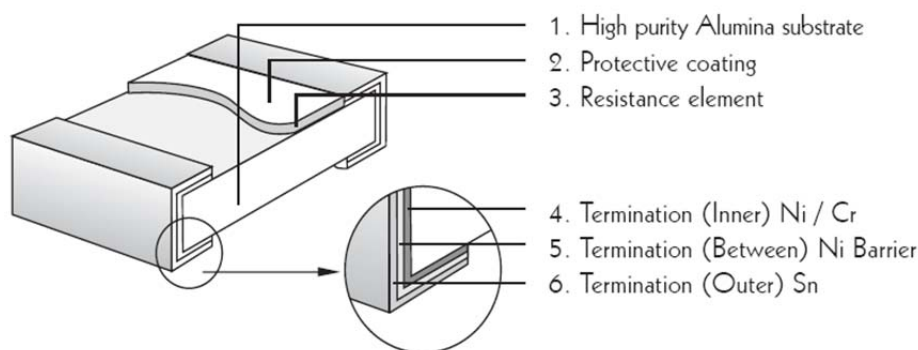

## 12. Performance Specification

Characteristic	Limits	Test Methods (GB/T5729&JIS-C-5201&IEC60115-1)
Temperature Coefficient	$1\Omega \leq R \leq 10\Omega: \pm 400\text{PPM}/^\circ\text{C}$ $10\Omega < R \leq 10\text{M}: \pm 100\text{PPM}/^\circ\text{C}$	4.8 Natural resistance changes per temp. Degree centigrade $\frac{R_2 - R_1}{R_1(t_2 - t_1)} \times 10^6 \text{ (PPM}/^\circ\text{C)}$ R <sub>1</sub> : Resistance Value at room temperature (t <sub>1</sub> ) ; R <sub>2</sub> : Resistance at test temperature (Upper limit temperature or Lower limit temperature) t <sub>1</sub> : +25°C or specified room temperature t <sub>2</sub> : Upper limit temperature or Lower limit temperature test temperature
Short-time overload	±(1.0%+0.1Ω)	4.13 Permanent resistance change after the application of 2.5 times RCWV for 5 seconds.
Terminal bending	±(1.0%+0.05Ω)	4.33 Twist of test board: Y/X = 3/90 mm for 60Seconds
Solderability	Coverage must be over 95%.	4.17 The area covered with a new, smooth, clean, shiny and continuous surface free from concentrated pinholes. Temperature of solder: 245±3°C; Dwell time in solder: 2~3 seconds.
Dielectric withstanding voltage	No evidence of flashover mechanical damage, arcing or insulation breakdown.	4.7 Clamped in the trough of a 90°C metallic V-block and shall be tested at ac potential respectively specified in the type for 60-70 seconds
Soldering heat	±(1.0%+0.05Ω)	4.18 Dipping the resistor into a solder bath having a temperature of 260°C±5°C and hold it for 10±1 seconds
Rapid change of temperature	±(1.0%+0.05Ω)	4.19 30 min at lower limit temperature and 30 min at upper limit temperature , 100 cycles.
Load life in humidity	±(3.0%+0.1Ω)	7.9 Resistance change after 1,000 hours (1.5 hours “ON”, 0.5 hour “OFF”) at RCWV in a humidity chamber controlled at 40°C±2°C and 90 to 95% relative humidity.
Load life	±(3.0%+0.1Ω)	4.25.1 Permanent resistance change after 1,000 hours operating at RCWV with duty cycle 1.5 hours “ON”, 0.5 hour “OFF” at 70°C±2°C ambient.
Humidity ( steady state )	±(3.0%+0.1Ω)	4.24 Temporary resistance change after 240 hours exposure in a humidity test chamber controlled at 40±2°C and 90-95% relative humidity,
Low Temperature Storage	±(3.0%+0.1Ω)	4.23.4 Lower limit temperature , for 2H.
High Temperature	±(3.0%+0.1Ω)	4.23.2 Upper limit temperature , for 1000H.

Exposure		
Leaching	No visible damage	J-STD-002 Test D Samples completely immersed for 30 sec in solder bath at 260°C

**13. Soldering Condition**

**(This is for recommendation, please customer perform adjustment according to actual application)**

13.1 Recommend Reflow Soldering Profile : (solder : Sn96.5 / Ag3 / Cu0.5)

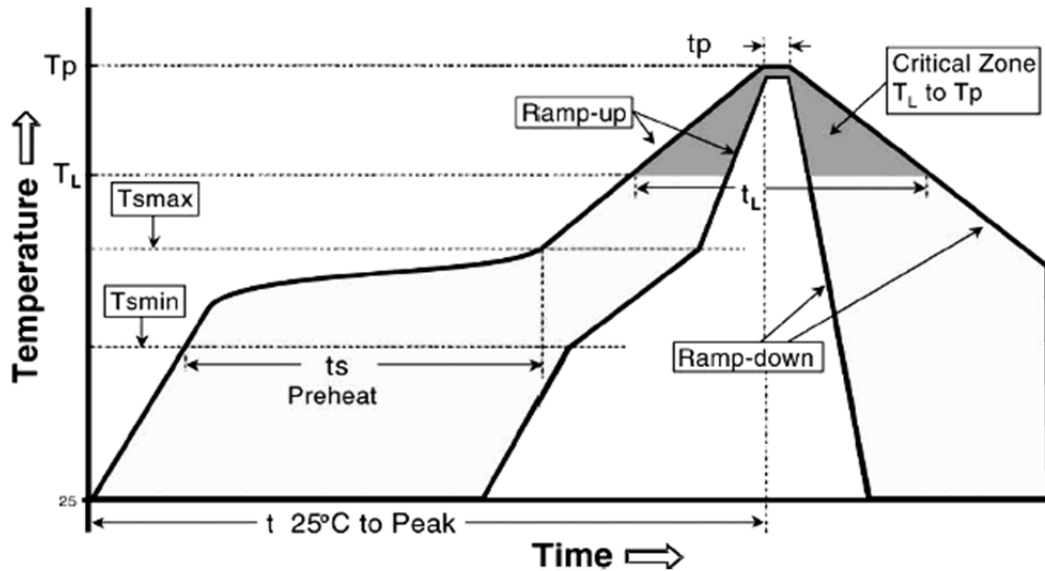

Profile Feature	Lead (Pb)-Free solder
Preheat:	
Temperature Min ( $T_{s_{min}}$ )	150°C
Temperature Max ( $T_{s_{max}}$ )	200°C
Time ( $T_{s_{min}}$ to $T_{s_{max}}$ ) ( $t_s$ )	60 -120 seconds
Average ramp-up rate: ( $T_{s_{max}}$ to $T_p$ )	3°C / second max.
Time maintained above :	
Temperature ( $T_l$ )	217°C
Time ( $t_l$ )	60-150 seconds
Peak Temperature ( $T_p$ )	260°C
Time within $+0$ $-5$ °C of actual peak Temperature ( $t_p$ ) <sup>2</sup>	10 seconds
Ramp-down Rate	6°C/second max.
Time 25°C to Peak Temperature	8minutes max.

Allowed Re-flow times : 2 times

Remark : To avoid discoloration phenomena of chip on terminal electrodes, please use N2 Re-flow furnace .

13.2 Recommend Wave Soldering Profile : (Apply to 0603 and above size)





**13. Packing**

13.1 Dimension of Paper Taping :(Unit: mm)

Type	A ±0.10	B ±0.10	C ±0.05	ΦD <sup>+0.1</sup> <sub>-0</sub>	E ±0.1	F ±0.05	G ±0.1	W ±0.2	T ±0.05
AS02	0.65	1.20	2.00	1.50	1.75	3.50	4.00	8.00	0.42

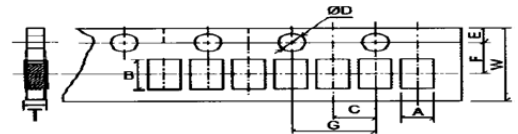

TYPE	A ±0.2	B ±0.2	C ±0.05	ΦD <sup>+0.1</sup> <sub>-0</sub>	E ±0.1	F ±0.05	G ±0.1	W ±0.2	T ±0.10
AS03	1.10	1.90	2.00	1.50	1.75	3.50	4.00	8.00	0.67
AS05	1.65	2.40	2.00	1.50	1.75	3.50	4.00	8.00	0.81
AS06	2.00	3.60	2.00	1.50	1.75	3.50	4.00	8.00	0.81
AS07	2.80	3.50	2.00	1.50	1.75	3.50	4.00	8.00	0.75



13.2 Dimension of plastic taping: (Unit: mm)

Type	A ±0.2	B ±0.2	C ±0.05	ΦD <sup>+0.1</sup> <sub>-0</sub>	ΦD1 <sup>+0.25</sup> <sub>-0</sub>	E ±0.1	F ±0.05	G ±0.1	W ±0.2	T ±0.1
AS10	2.90	5.60	2.00	1.50	1.50	1.75	5.50	4.00	12.00	1.00
AS12	3.50	6.70	2.00	1.50	1.50	1.75	5.50	4.00	12.00	1.00

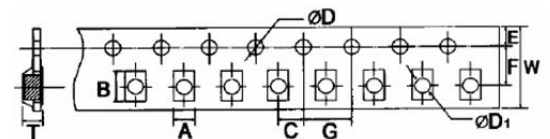

13.3 Dimension of Reel : (Unit: mm)

Type	Taping	Size	A±0.5	B±0.5	C±0.5	D±1	M±2	W±1
AS02	Paper	10,000pcs	2.0	13.0	21.0	60.0	178.0	10.0
AS03		5000pcs	2.0	13.0	21.0	60.0	178.0	10.0
AS05			2.0	13.0	21.0	60.0	178.0	10.0
AS06			2.0	13.0	21.0	60.0	178.0	10.0
AS07			2.0	13.0	21.0	60.0	178.0	10.0
AS10	Embossed	4000pcs	2.0	13.0	21.0	60.0	178.0	13.8
AS12			2.0	13.0	21.0	60.0	178.0	13.8

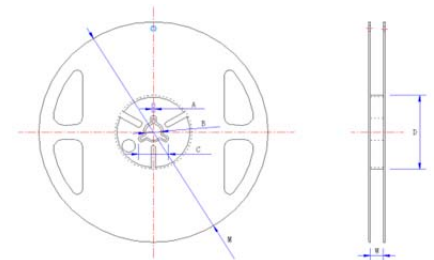

**14. Note**

14.1. UNI-ROYAL recommend products store in warehouse with temperature between 15 to 35°C under humidity between 25 to 75%RH.

Even under storage conditions recommended above, solder ability of products will be degraded stored over 1 year old.

14.2. Cartons must be placed in correct direction which indicated on carton, otherwise the reel or wire will be deformed.

14.3. Storage conditions as below are inappropriate:

- a. Stored in high electrostatic environment
- b. Stored in direct sunshine, rain, snow or condensation.
- c. Exposed to sea wind or corrosive gases, such as Cl<sub>2</sub>, H<sub>2</sub>S, NH<sub>3</sub>, SO<sub>2</sub>, NO<sub>2</sub>, etc.

## 15. Record

Version	Description	Page	Date	Amended by	Checked by
1	First version	1~7	Mar.20, 2018	Haiyan Chen	Nana Chen
2	Modify characteristic	5~6	Feb.13, 2019	Haiyan Chen	Yuhua Xu
3	Modify the High Temperature Exposure conditions	7	July.29, 2019	Haiyan Chen	Yuhua Xu
4	Modify the High Temperature Exposure conditions	7	July.29, 2019	Haiyan Chen	Yuhua Xu
5	Modify the reflow curve and add the wave soldering curve	6~7	Apr.29, 2020	Haiyan Chen	Yuhua Xu

© Uniroyal Electronics Global Co., Ltd. All rights reserved. Specification herein will be changed at any time without prior notice.



## X-ON Electronics

Largest Supplier of Electrical and Electronic Components

*Click to view similar products for [Thick Film Resistors - SMD category](#):*

*Click to view products by [Uniroyal manufacturer](#):*

Other Similar products are found below :

[CRCW04028R20JNEE](#) [CRCW06036K80FKEE](#) [CRG1206F1K58](#) [CRL0603-FW-R700ELF](#) [M55342K06B6E19RWL](#) [RC1005F1072CS](#)  
[RC1005F471CS](#) [RC1005F4751CS](#) [RCP0603W100RGED](#) [RCWP72251K47FKWB](#) [RLR05C7501GPB14](#) [RLR07C5111FSBSL](#) [ERJ-](#)  
[1GMF1R00C](#) [ERJ-1GMF1R20C](#) [ERJ-1GMF2R55C](#) [ERJ-1GMF8R66C](#) [25121WF1003T4E](#) [25.501.3653.0](#) [290-1.0M-RC](#) [292-1.0M-RC](#) [292-](#)  
[2.2K-RC](#) [292-4.7K-RC](#) [25121WF4700T4E](#) [292-470K-RC](#) [302-1.0M-RC](#) [CPG1206F10KC](#) [CRCW02011R00FXED](#) [CRCW060315K0FKEE](#)  
[CRCW060320K5FKEE](#) [CRG0201F10K](#) [RCG0402150RFKED](#) [RCG04023K92FKED](#) [RCP2512B100RGWB](#) [RCWP110010R0FKS3](#)  
[RCWP11002K00FKS3](#) [RCWP12061K00FKS2](#) [3520510RJT](#) [352075KJT](#) [M55342K11B9E53RUL](#) [RMC16-102JT](#) [RMC1JPTE](#) [TR0603MR-](#)  
[075K1L](#) [5-2176094-4](#) [35202K7JT](#) [WF06Q1000FTL](#) [ERJ-S03J1R0V](#) [ERJ-S14J4R7U](#) [CHP2512L4R30GNT](#) [CPCC10270R0JE32](#)  
[RCWP11001K00FKS3](#)