



ISO14001



ISO/TS16949



244546



245468



REG.-Nr.A759



CQC04001010656

Specification for Approval

Customer : 深圳市立創電子商務有限公司

Product Name : LEAD-FREE CARBON FILM FIXED RESISTORS

Part Name : CFR SERIES $\pm 2\%$ 、 $\pm 5\%$ 、 $\pm 10\%$

Part No. : CFR0**G*****0; CFR0**J*****0;
CFR0**K*****0

65 Dengta Road, Yushan Town, Kun Shan City, Jiang Su Province, China

TEL: 86 512 57631411 / 22 / 33

FAX: 86 512 57631431

E-mail: globalsales@uniohm.com localsales@uniohm.com

Approved	Checked	Prepared	File NO.	Edition	Date	Page
William Zhao	Apple Liu	Wu Yiyun	JL-01-004	1	2015.09.16	1/13



ISO14001



ISO/TS16949



244546



245468



REG.-Nr.A759



CQC04001010656

Contents

Introduction..	Page
1.0 Scope..	4
2.0 Ratings & Dimension.....	4
3.0 Construction.....	5
4.0 Resistor marked.....	5
5.0 Derating Curve.....	6
6.0 Voltage rating.....	6
7.0 Performance Specification.....	6
8.0 Explanation of Part No. System.....	8
9.0 Ordering Procedure.....	9
10.0 Standard Packing.....	10
11.0 Precaution for storage/Transportation.....	13

Approved	Checked	Prepared	File NO.	Edition	Date	Page
William Zhao	Apple Liu	Wu Yiyun	JL-01-004	1	2015.09.16	2/13



ISO14001



ISO/TS16949



244546



245468



REG.-Nr.A759



CQC04001010656

File Name: CFR SERIES ±2%、5%、±10%		Date	2015.09.16	Edition No.	1
Amendment Record				Signature	
Edition	Prescription of amendment	Amend Page	Amend Date	Amended by	Checked by

Approved	Checked	Prepared	File NO.	Edition	Date	Page
William Zhao	Apple Liu	Wu Yiyun	JL-01-004	1	2015.09.16	3/13



ISO14001



ISO/TS16949



244546



245468



REG.-Nr.A759



CQC04001010658

1.0 Scope:

This specification for approve relates to Lead-Free Carbon Film Fixed Resistors manufactured by UNIOHM.

2.0 Ratings & Dimension:

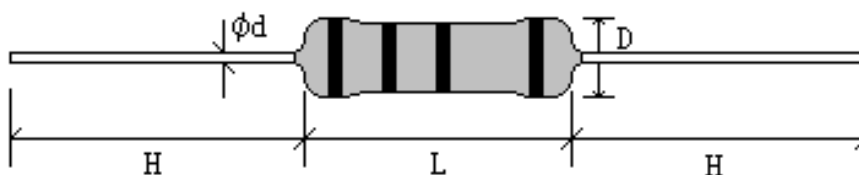

2.1 Normal size

Type	Dimension(mm)				Max Working Voltage	Max Overload Voltage	Dielectric Withstanding Voltage	Tolerance	Resistance Range
	D	L	d ±0.05	H ±3					
CR 1/8W	1.9±0.3	3.3±0.3	0.45	28	200V	400V	400V	±2%、±5%、±10%	1Ω~10MΩ
CR 1/4W	2.2±0.3	6.5±1.0	0.54	28	250V	500V	500V	±2%、±5%、±10%	1Ω~10MΩ
CR 1/2W	3.0±0.6	9.5±1.0	0.54	28	350V	700V	700V	±2%、±5%、±10%	1Ω~10MΩ
CR 1W	5.0±0.6	15.5±1.0	0.70	28	500V	1000V	1000V	±2%、±5%、±10%	1Ω~10MΩ
CR 2W	6.0±0.6	17.5±1.0	0.75	28	500V	1000V	1000V	±2%、±5%、±10%	1Ω~10MΩ

2.2 Small Size & Extra Small Size

Type	Dimension(mm)				Max Working Voltage	Max Overload Voltage	Dielectric Withstanding Voltage	Tolerance	Resistance Range
	D	L	d ±0.05	H ±3					
CR 1/4WS	1.9±0.3	3.3±0.3	0.45	28	200V	400V	400V	±2%、±5%、±10%	1Ω~10MΩ
CR 1/2WSS	2.2±0.5	6.5±1.0	0.54	28	250V	500V	250V	±2%、±5%、±10%	1Ω~10MΩ
CR 1/2WS	3.0±0.5	9.0±1.0	0.54	28	350V	700V	700V	±2%、±5%、±10%	1Ω~10MΩ
CR 1WS	4.0±0.6	11.5±1.0	0.65	28	500V	1000V	1000V	±2%、±5%、±10%	1Ω~10MΩ
CR 2WS	5.0±0.6	15.5±1.0	0.70	28	500V	1000V	1000V	±2%、±5%、±10%	1Ω~10MΩ
CR 3WS	6.0±0.6	17.5±1.0	0.75	28	500V	1000V	1000V	±2%、±5%、±10%	1Ω~10MΩ

Approved	Checked	Prepared	File NO.	Edition	Date	Page
William Zhao	Apple Liu	Wu Yiyun	JL-01-004	1	2015.09.16	4/13



3.0 Construction:



No.	Name	Material
1	Basic Body	Rod Type Ceramics
2	Resistor	Carbon Film
3	End Cap	Cold steel plated with copper/tin
4	Lead Wire	Tin solder coated copper wire
5	Joint	By welding
6	Coating	(1). Celluloid paint
		(2). Insulated Resin
		Color: Beige(1/8W,1/4WS,1/2WS,1/4W,1/2W,1W,2W) Light Brown(1WS,2WS,3WS) Gray Green(1/2WSS)
7	Color Code	Epoxy resin

4.0 Resistor Marked:

Resistors shall be marked with color coding
Colors shall be in accordance with JIS C 0802

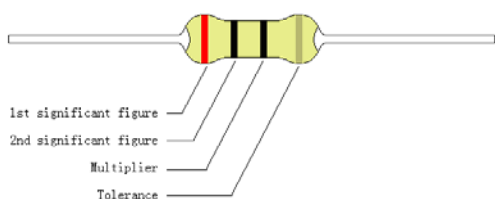

Example:

CARBON FILM FIXED RESISTORS	
WATT: 1/2WS	VAL: 100Ω
Q'TY: 2,000	TOL: 5%
LOT: 1021548	PPM:

4.1 Label:

Label shall be marked with following items:

- (1) Type and style
- (2) Nominal resistance
- (3) Resistance tolerance

Approved	Checked	Prepared	File NO.	Edition	Date	Page
William Zhao	Apple Liu	Wu Yiyun	JL-01-004	1	2015.09.16	5/13



ISO14001

ISO/TS16949

244546

245468

REG.-Nr.A759

CQC04001010656

- (4) Quantity
- (5) Lot number
- (6) PPM

5.0 Derating Curve:

Resistors shall have a power rating based on continuous load operation at an ambient temperature from -55°C to 70°C. For temperature in excess of 70°C, the load shall be derate as shown in figure 1

Figure1



6.0 Voltage rating:

Resistors should have a direct-current (DC) continuous voltage rating and an alternating-current (AC) continuous voltage rating relates to Power Rating, formula shown as below:

$$RCWV = \sqrt{P \cdot R}$$

RCWV: Rated dc or RMS ac continuous working voltage at commercial-line frequency and waveform (Volt.)

P: Power Rating (Watt.)

R: Nominal Resistance (Ohm)

Resistors will be burned out if it overload, such as higher than the maximum value of series' RCWV. And we named 2.5 times RCWV is OVERLOAD Voltage.

7.0 Performance Specification:

Characteristic	Limits		Test Method (JIS-C-5201& JIS-C-5202)
	Range	T.C.R. (PPM/°C)	
Temperature Coefficient	≤10Ω	± 300	4.8 natural resistance changes per temp. Degree centigrade $\frac{R_2 - R_1}{R_1(T_2 - T_1)} \times 10^6 (PPM/°C)$ R1: Resistance value at room temp. (T ₁) R2: Resistance value at room temp.+100°C (T ₂) Test pattern: room temp. (T ₁), room temp. +100°C(T ₂)
	10Ω<R<100KΩ	± 450	
	100KΩ≤R≤1MΩ	0 ~ - 700	
	1MΩ<R≤10MΩ	0 ~ - 1500	
Short-time overload	Resistance change rate is: ±(1%+0.05Ω)Max. With no evidence of mechanical damage.		4.13 Permanent resistance change after the application of a potential of 2.5 times RCWV for 5 seconds.

Approved	Checked	Prepared	File NO.	Edition	Date	Page
William Zhao	Apple Liu	Wu Yiyun	JL-01-004	1	2015.09.16	6/13



ISO14001



ISO/TS16949



244546



245468



REG.-Nr.A759



CQC04001010656

Insulation resistance	Insulation resistance is: 10,000 MΩ Min.	4.6 The measuring voltage shall be either (100±15) V DC for resistors with an isolation voltage <500V or (500±50)V DC. for resistors with an isolation voltage ≥500V															
Dielectric withstanding voltage	No evidence of flashover mechanical damage, arcing or insulation breaks down.	4.7 Resistors shall be clamped in the trough of a 90°C metallic v-block and shall be tested at AC potential respectively specified in the given list of each product type for 60-70 seconds.															
Terminal strength	No evidence of mechanical damage	4.16 direct load: Resistance to a 2.5 Kg direct load for 10 seconds in the direction of the longitudinal axis of the terminal leads. Twist test: Terminal leads shall be bent through 90° at a point of about 6mm from the body of the resistor and shall be rotated through 360° about the original axis of the bent terminal in alternating direction for a total of 3 rotations.															
Resistance to soldering heat	Resistance change rate is: ±(1%+0.05Ω) Max. With no evidence of mechanical damage.	4.18 permanent resistance change when leads immersed to a point 2.0-2.5mm from the body in 260°C±5°C solder for 10±1 seconds.															
Solderability	95% coverage Min.	4.17 The area covered with a new, smooth, clean, shiny and continuous surface free from concentrated pinholes. Test temp. Of solder: 245°C ± 3°C Dwell time in solder 2~3 seconds.															
Temperature Cycling	Resistance change rate is: ±(1%+0.05Ω) max.. With no evidence of mechanical damage.	4.19 resistance change after continuous five cycles for duty cycle specified below: <table border="1" data-bbox="837 1344 1388 1512"> <thead> <tr> <th>Step</th> <th>Temperature</th> <th>Time</th> </tr> </thead> <tbody> <tr> <td>1</td> <td>-55°C ± 3°C</td> <td>30 mins</td> </tr> <tr> <td>2</td> <td>Room temp.</td> <td>10 - 15 mins</td> </tr> <tr> <td>3</td> <td>+155°C ± 2°C</td> <td>30 mins</td> </tr> <tr> <td>4</td> <td>Room temp.</td> <td>10 - 15 mins</td> </tr> </tbody> </table>	Step	Temperature	Time	1	-55°C ± 3°C	30 mins	2	Room temp.	10 - 15 mins	3	+155°C ± 2°C	30 mins	4	Room temp.	10 - 15 mins
Step	Temperature	Time															
1	-55°C ± 3°C	30 mins															
2	Room temp.	10 - 15 mins															
3	+155°C ± 2°C	30 mins															
4	Room temp.	10 - 15 mins															
Load life in humidity	Normal type: ΔR/R ±3% for <100KΩ ±5% for ≥ 100KΩ Flame retardant type: ΔR/R ±5% for <100KΩ; ±10% for ≥100KΩ;	7.9 Resistance change after 1,000 hours (1.5 hours "ON", 0.5 hour "OFF") at RCWV in a humidity test chamber controlled at 40°C±2°C and 90 to 95% relative humidity.															
Load life	Normal type: ΔR/R ±2% for <56KΩ ±3% for ≥56KΩ Flame retardant type: ΔR/R ±5% for <100KΩ; ±10% for ≥100KΩ;	4.25.1 Permanent resistance change after 1,000 hours operating at RCWV with duty cycle of 1.5 hours "ON", 0.5 hour "OFF" at 70°C ± 2°C ambient.															

Approved	Checked	Prepared	File NO.	Edition	Date	Page
William Zhao	Apple Liu	Wu Yiyun	JL-01-004	1	2015.09.16	7/13



ISO14001



ISO/TS16949



244546



245468



REG.-Nr.A759



CQC04001010656

8.0 Explanation of Part No. System:

The standard Part No. includes 14 digits with the following explanation:

8.1 11st ~4th : Product series name

Example: CFR0= Carbon Film Fixed Resistors

8.2 5th~6th:

8.2.1 Power rating.

W=Normal Size; S=Small Size; U=Extra Small Size;

“1”~“G”to denotes“1”~“16”as Hexadecimal:

1/16W~1/2W (<1W)

Wattage	1/2	1/3	1/4	1/5	1/6	1/8	1/10	1/16
Normal Size	W2	W3	W4	W5	W6	W8	WA	WG
Small Size	S2	S3	S4	S5	S6	S8	SA	SG
Extra Small Size	U2	U3	U4	U5	U6	U8	UA	UG

1W~16W (≥1W)

Wattage	1	2	3	5	7	8	9	10	15
Normal Size	1W	2W	3W	5W	7W	8W	9W	AW	FW
Small Size	1S	2S	3S	5S	7S	8S	9S	AS	FS
Extra Small Size	1U	2U	3U	5U	7U	8U	9U	AU	FU

8.2.2 For power rating less than 1 watt, the 5th digit will be the letters W, S or U to represent the size required & the 6th digit will be a number or a letter code.

Example: W4=1/4W; S2=1/2W-S.

8.2.3 For power of 1 watt to 16 watt, the 5th digit will be a number or a letter code and the 6th digit will be the letters of W, S or U.

Example: AW=10W; 3S=3W-S

8.3 7th: Resistance Tolerance.

G=±2% J=±5% K=±10%

8.4 8th~11th: Resistance Value

8.4.1 For the standard resistance values of E-24 series, the 8th digit is “0”,the 9th & 10th digits are to denote the significant figures of the resistance and the 11th digit is the number of zeros following;

8.4.2 The following number s and the letter codes are to be used to indicate the number of zeros in the 11th digit:

0=10⁰ 1=10¹ 2=10² 3=10³ 4=10⁴ 5=10⁵
6=10⁶ J=10⁻¹ K=10⁻² L=10⁻³ M=10⁻⁴

8.5 12th~14th digits.

8.5.1 12th: Packaging Type

A=Tape/Box (Ammo pack) B=Bulk/Box

Approved	Checked	Prepared	File NO.	Edition	Date	Page
William Zhao	Apple Liu	Wu Yiyun	JL-01-004	1	2015.09.16	8/13



ISO14001

ISO/TS16949

244546

245468

REG.-Nr.A759

CQC04001010656

T=Tape/Reel

P=Tape/Box of PT-26 products

8.5.2 13th: Packing Quantity

Packing quantities code:

A=500pcs B=2500pcs 1=1000pcs 2=2000pcs

8.5.3 For the FORMED type products, the 13th & 14th digits are used to denote the forming types of the product with the following letter codes:

MF=M-type with flattened lead wire

F0= F-type

MK= M-type with kinked lead wire

F1= F1-type

ML= M-type with normal lead wire

F2= F2-type

MC= M type with kinked lead and narrow pitch wire

F3= F3-type

8.5.4 14th: Special features of additional information with the following codes:

P=Panaset type

1=Avisert type 1

2=Avisert type 2

3=Avisert type 3

A=Cutting type CO 1/4W-A type

B= Cutting type CO 1/4W-B type

9.0 Ordering Procedure (Example: CFR 1/2W ±5% 100Ω T/B-1000)

C F R 0 W 2 J 0 1 0 1 A 1 0



Approved	Checked	Prepared	File NO.	Edition	Date	Page
William Zhao	Apple Liu	Wu Yiyun	JL-01-004	1	2015.09.16	9/13



ISO14001



ISO/TS16949



244546



245468



REG.-Nr.A759



CQC04001010656

10.0 Standard Packing:

10.1 Tapes in Box Packing

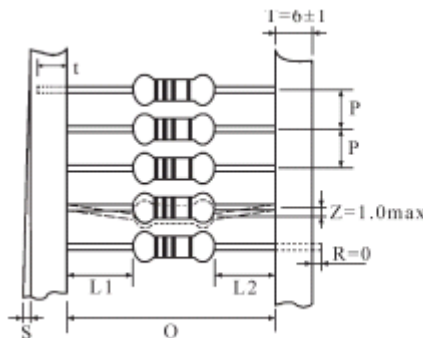
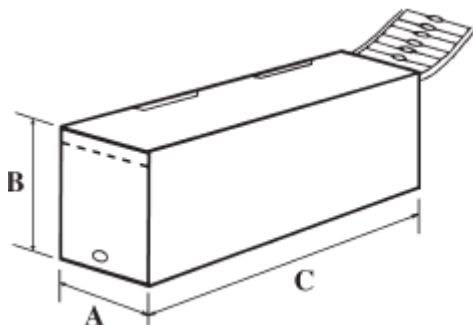

*L1-L2=1.0 Max.
 ZW: 0
 **S=0.5 Max.
 PT-26: 0.8 Max.

Dimension of T/B (mm)

TYPE	O	P	W (A)±5	H (B)±5	L (C)±5	Quantity Per Box
CR 1/8W	52±1	5±0.3	75	70	255	5,000pcs
CR 1/4WS	52±1	5±0.3	75	70	255	5,000pcs
CR 1/4W	52±1	5±0.3	75	98	255	5,000pcs
CR 1/2WSS	52±1	5±0.3	75	116	255	5,000pcs
CR 1/2WS	52±1	5±0.3	75	70	255	2,000pcs
CR 1/2W	52±1	5±0.3	75	45	255	1,000pcs
CR 1WS	58±1	5±0.3	80	82	255	1,000pcs
CR 1W	65±5	10±0.5	90	88	255	1,000pcs
CR 2WS	65±5	10±0.5	90	88	255	1,000pcs
CR 2W	65±5	10±0.5	90	88	255	500pcs
CR 3WS	65±5	10±0.5	90	88	255	500pcs

Approved	Checked	Prepared	File NO.	Edition	Date	Page
William Zhao	Apple Liu	Wu Yiyun	JL-01-004	1	2015.09.16	10/13



10.2 Tapes in Reel Packing



Dimension of Reel (mm)

Type	A	W±5	H±5	L±5	Quantity Per Reel
CR 1/8W	73±2	85	295	293	5,000pcs
CR 1/4WS	73±2	85	295	293	5,000pcs
CR 1/4W	73±2	85	295	293	5,000pcs
CR 1/2WSS	73±2	85	295	293	5,000pcs
CR 1/2WS	73±2	85	295	293	4,000pcs
CR 1/2W	73±2	85	295	293	4,000pcs
CR 1WS	73±2	85	295	293	2,500pcs
CR 1W	80±5	95	295	293	1,000pcs
CR 2WS	80±5	95	295	293	1,000pcs
CR 2W	80±5	95	295	293	1,000pcs
CR 3WS	80±5	95	295	293	1,000pcs

Approved	Checked	Prepared	File NO.	Edition	Date	Page
William Zhao	Apple Liu	Wu Yiyun	JL-01-004	1	2015.09.16	11/13



ISO14001



ISO/TS16949



244546



245468



REG.-Nr.A759



CQC04001010656

10.3 Bulk in Box Packing



Dimension of Box (mm)

Type	A±5	B±5	C±5	Quantity Per Reel
CR 1/8W	140	80	240	1,000/20,000pcs
CR 1/4WS	140	80	240	1,000/20,000pcs
CR 1/4W	140	80	240	500/10,000pcs
CR 1/2WSS	140	80	240	250/10,000pcs
CR 1/2WS	140	80	240	500/8,000pcs
CR 1/2W	140	80	240	250/5,000pcs
CR 1WS	140	80	240	100/2,500pcs
CR 1W	140	80	240	100/1,500pcs
CR 2WS	140	80	240	100/1,500pcs
CR 2W	140	80	240	100/1,000pcs
CR 3WS	140	80	240	100/1,000pcs

Approved	Checked	Prepared	File NO.	Edition	Date	Page
William Zhao	Apple Liu	Wu Yiyun	JL-01-004	1	2015.09.16	12/13



ISO14001



ISO/TS16949



244546



245468



REG.-Nr.A759



CQC04001010656

11.0 Precaution for storage/Transportation:

11.1 UNIOHM recommends the storage condition as below:

11.1.1 Temperature: 15°C~35°C.

11.1.2 Humidity: 25%~75%RH.

11.1.3 Those condition recommended are for individual product.

11.1.4 Even under recommended condition, products' solderability will degrade if store more than 1 year.

11.2 Please hold the cartons in correct direction signed on cartons' side during storage and delivery, or else, it will lead the products abnormal to use.

11.3 Resistors' performance and solderability will fail if stored in the following condition:

11.3.1 High electrostatic environment.

11.3.2 Direct sunlight, rain, snow, and so on.

11.3.3 Hold in sea wind or corrosive gases long time, including Cl₂, H₂S, NH₃, SO₂, NO₂, etc.

Approved	Checked	Prepared	File NO.	Edition	Date	Page
William Zhao	Apple Liu	Wu Yiyun	JL-01-004	1	2015.09.16	13/13

X-ON Electronics

Largest Supplier of Electrical and Electronic Components

Click to view similar products for [Carbon Composition Resistors](#) category:

Click to view products by [Uniroyal](#) manufacturer:

Other Similar products are found below :

[OG5625](#) [OB1025](#) [OC2255](#) [OH6205](#) [RC0S2CA270RKE](#) [RC1/4272KB](#) [OF110JE-TR](#) [3-1625875-1](#) [RC1/22R2JTD](#) [RC12JB3R30](#)
[CF18JT910R](#) [RC20GF240J](#) [RC20GF561J](#) [RC1/4435JB](#) [RC1/4135JB](#) [RC12JB15K0](#) [RC12JB82R0](#) [RC14JB12R0](#) [RC14JB180R](#)
[RC14JB330R](#) [RC1/4201JTD](#) [RC20GF470JTRLF](#) [RC1/2155KTD](#) [RC1/4274KTD](#) [RC1/47R5JB](#) [RC1/4565JB](#) [RC1/4160JB](#) [RC1/2475KTB](#)
[RC1/2431JTD](#) [RC1/2166KTD](#) [RC1/2102JTD](#) [RC1/2434JB](#) [RC1/22R4JB](#) [RC07GF510JTR](#) [RCC025 2R7 J B](#) [CBT50J6K8](#) [OA182KE](#)
[OA682KE](#) [OD130JE](#) [OD222J](#) [OF106KE](#) [CBT25J680K](#) [CBT25J68K](#) [CBT25J6R8](#) [CBT50J1M5](#) [CBT50J1R0](#) [CBT50J27R](#) [CBT50J330K](#)
[CBT50J47R](#) [CBT50J6M8](#)