

UNI-ROYAL
厚聲集團

DATA SHEET

Product Name High-Power Thick Film Chip Resistors

Part Name HP Series

Uniroyal Electronics Global Co., Ltd.

88 Longteng Road, Economic & Technical Development Zone, Kunshan, Jiangsu, China

Tel +86 512 5763 1411 / 22 /33

Email marketing@uni-royal.cn

Manufacture Plant Uniroyal Electronics Industry (kunshan) co., ltd.
Uniroyal Electronics Industry Co., Ltd.
Uniroyal Electronics Global Co.,Ltd Shenzhen Branch
Aeon Technology Corporation
Uniroyal Electronics Global Co.,Ltd Xiamen Branch
Kunshan Foss Electronic material Co., Ltd.
Royal Electronic Factory (thailand) co., ltd

Brands *RoyalOhm* *UniOhm*



1. Scope

- 1.1 This specification for approve relates to the High Power Thick Film Chip Resistors manufactured by UNI-ROYAL.
 1.2 High power standard size
 1.3 Suitable for both wave & re-flow soldering
 1.4 Application: AV adapters, LCD back-light, camera strobe ect.

2. Explanation of Part No. System

Part No. includes 14 codes shown as below:

2.1 1st~4th codes: Part name. E.g.: HP02、HP03、HP05、HP06、HP07、HP10、HP11、HP12

2.2 5th~6th codes: Power rating.

E.g.: W=Normal Size		"1~G" = "1~16"									
Wattage	1/32	3/4	1/2	1/3	1/4	1/8	1/10	1/16	1/20	1	
Normal Size	WH	07	W2	W3	W4	W8	WA	WG	WM	1W	

If power rating is lower or equal than 1 watt, 5th code would be "W" and 6th code would be a number or letter.

E.g.: WA=1/10W W4=1/4W

2.3 7th code: Tolerance. E.g.: D=±0.5% F=±1% G=±2% J=±5% K= ±10%

2.4 8th~11th codes: Resistance Value.

2.4.1 If value belongs to standard value of ≥5% series, 8th code would be zero, 9th~10th codes are significant figures of the resistance and 11th code is the power of ten.

2.4.2 If value belongs to standard value of ≤2% series, 8th~10th codes are significant figures of the resistance, and 11th code is the power of ten.

2.4.3 11th codes listed as following:

0=10⁰ 1=10¹ 2=10² 3=10³ 4=10⁴ 5=10⁵ 6=10⁶ J=10⁻¹ K=10⁻² L=10⁻³ M=10⁻⁴

2.5 12th~14th codes.

2.5.1 12th code: Packaging Type. E.g.: C=Bulk T=Tape/Reel

2.5.2 13th code: Standard Packing Quantity.

4=4000pcs 5=5000pcs C=10000pcs D=20000pcs E=15000pcs

Chip Product: BD=B/B-20000pcs TC=T/R-10000pcs

2.5.3 14th code: Special features.

E = Environmental Protection, Lead Free, or Standard type.

3. Ordering Procedure

(Example: HP12 2W ±5% 10KΩ T/R-4000)

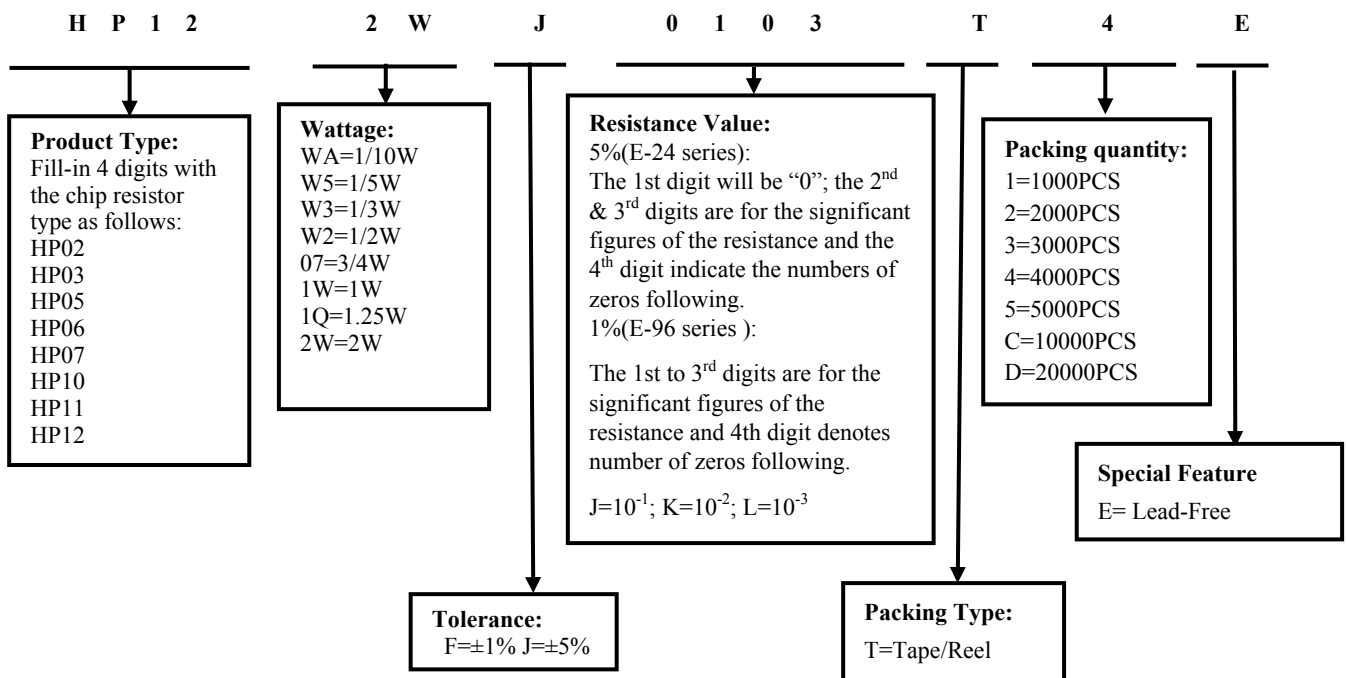

4. Marking

(1) For HP02 size. Due to the very HP02 small size of the resistor's body, there is no marking on the body.



Normally, the marking of 0Ω HP03, 0Ω HP05, 0Ω HP06, 0Ω HP07, 0Ω HP10, 0Ω HP11, 0Ω HP12, 0Ω SP12, resistors as following



0 → 0Ω

(2) ±2%, ±5% Tolerance: The first two digits are significant figures of resistance and the third denotes number of zeros following



333 → 33KΩ

(3) ±0.5% · ±1% Tolerance: 4 digits, first three digits are significant; fourth digit is number of zeros. Letter r is decimal point.



2701 → 2.7KΩ

(4) More than HP05 specifications (including) 4 digits, Product below 1Ω, show as following, the first digit is "R" which is decimal point.



R300 → 0.3Ω

5. Dimension

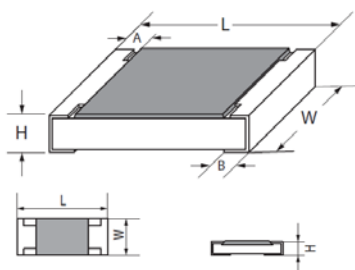

Type	Dimension(mm)				
	L	W	H	A	B
HP02(0402)	1.00±0.10	0.50±0.05	0.35±0.05	0.20±0.10	0.25±0.10
HP03(0603)	1.60±0.10	0.80±0.10	0.45±0.10	0.30±0.20	0.30±0.20
HP05(0805)	2.00±0.15	1.25+0.15/-0.10	0.55±0.10	0.40±0.20	0.40±0.20
HP06(1206)	3.10±0.15	1.55+0.15/-0.10	0.55±0.10	0.45±0.20	0.45±0.20
HP07(1210)	3.10±0.10	2.60±0.20	0.55±0.10	0.50±0.25	0.50±0.20
HP10(2010)	5.00±0.10	2.50±0.20	0.55±0.10	0.60±0.25	0.50±0.20
HP11(1812)	4.50±0.20	3.20±0.20	0.55±0.20	0.50±0.20	0.50±0.20
HP12(2512)	6.35±0.10	3.20±0.20	0.55±0.10	0.60±0.25	0.50±0.20

6. Resistance Range

Type	Size	70°C Power	Resistance Range of 1% & 5%	Max. Working Voltage	Max. Overload Voltage	Dielectric withstanding Voltage	Operating Temperature
HP02	0402	1/10W	1Ω~10M 0Ω	50V	100V Rmax=10mΩ, Imax=3A	100V	-55°C~155°C
HP03	0603	1/5W	0.1Ω~10M 0Ω	75V	150V Rmax=8mΩ, Imax=5A	300V	-55°C~155°C
HP05	0805	1/3W	0.01Ω~10M 0Ω	150V	300V Rmax=5mΩ, Imax=6A	500V	-55°C~155°C
HP06	1206	1/2W	0.01Ω~10M 0Ω	200V	400V Rmax=5mΩ, Imax=10A	500V	-55°C~155°C
HP07	1210	3/4W	0.1Ω~10M 0Ω	200V	500V Rmax=4mΩ, Imax=12A	500V	-55°C~155°C
HP10	2010	1W	0.01Ω~10M 0Ω	200V	500V Rmax=5mΩ, Imax=12A	500V	-55°C~155°C
HP11	1812	1.25W	0.1Ω~10M 0Ω	200V	500V Rmax=5mΩ, Imax=12A	500V	-55°C~155°C
HP12	2512	2W	0.01Ω~10M 0Ω	250V	500V Rmax=5mΩ, Imax=16A	500V	-55°C~155°C

7. Recommend the size of welding plate

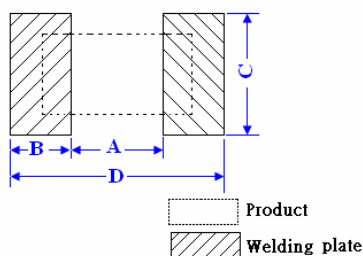

Type	Dimension(mm)			
	A	B	C	D
HP02	0.5±0.05	0.5±0.05	0.6±0.05	1.5±0.05
HP03	0.8±0.05	0.8±0.05	0.9±0.05	2.4±0.05
HP05	1.0±0.1	1±0.1	1.4±0.1	3±0.1
HP06	2.0±0.1	1.1±0.1	1.8±0.1	4.2±0.1
HP07	2.0±0.1	1.1±0.1	2.9±0.1	4.2±0.1
HP10	3.6±0.1	1.4±0.1	3±0.1	6.4±0.1
HP11	3.0±0.1	1.4±0.1	3.7±0.1	5.8±0.1
HP12	4.9±0.1	1.35±0.1	3.7±0.1	7.6±0.1

8. Derating Curve

Resistors shall have a power rating based on continuous load operation at an ambient temperature from -55°C to 70°C. For temperature in excess of 70°C, the load shall be derated as shown in figure 1

Figure 1

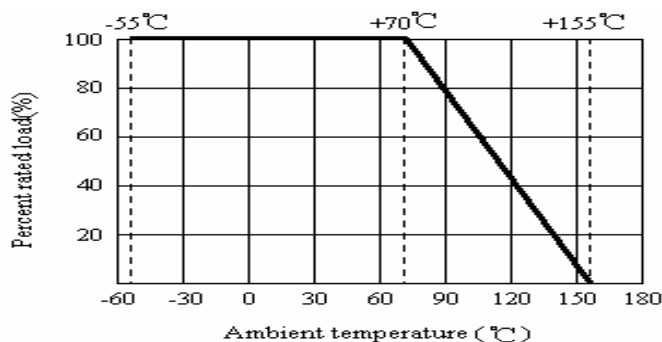

8.1 Voltage rating:

Resistors shall have a rated direct-current (DC) continuous working

Voltage or an approximate sine-wave root-mean-square (RMS) alternating-current (AC) continuous working voltage at commercial-line frequency and waveform corresponding to the power rating, as determined from the following formula:

$$RCWV = \sqrt{P \times R}$$

Where: RCWV commercial-line frequency and waveform (Volt.)

P = power rating (WATT.) R = nominal resistance (OHM)

In no case shall the rated DC or RMS AC continuous working voltage be greater than the applicable maximum value.

The overload voltage is 2.5 times RCWV or Max. Overload voltage whichever is less

8. Structure

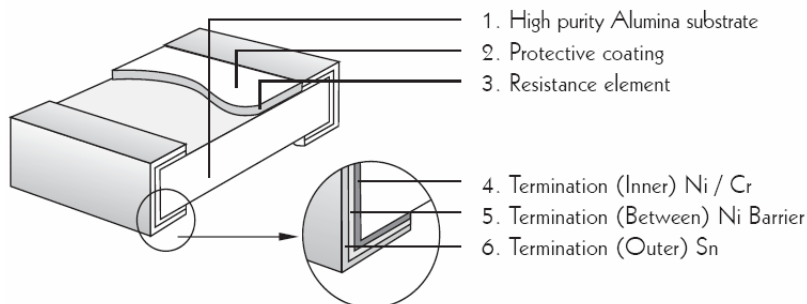

9. Performance Specification

Characteristic	Limits	Test Methods (GB/T5729&JIS-C-5201&IEC60115-1)
Temperature Coefficient	HP02: $1\Omega \leq R \leq 10\Omega$: ± 400 PPM/ $^{\circ}\text{C}$ $10\Omega < R \leq 100\Omega$: ± 200 PPM/ $^{\circ}\text{C}$ $100\Omega < R \leq 10\text{M}$: ± 100 PPM/ $^{\circ}\text{C}$	4.8 Natural resistance changes per temp. Degree centigrade $\frac{R_2 - R_1}{R_1(t_2 - t_1)} \times 10^6 \text{ (PPM}/^{\circ}\text{C)}$ R ₁ : Resistance Value at room temperature (t ₁) ; R ₂ : Resistance at test temperature (Upper limit temperature or Lower limit temperature) t ₁ : +25 $^{\circ}\text{C}$ or specified room temperature t ₂ : Upper limit temperature or Lower limit temperature test temperature
	HP03: $0.1\Omega \leq R < 0.2\Omega$: ± 200 PPM/ $^{\circ}\text{C}$ $0.2\Omega \leq R \leq 10\text{M}$: ± 100 PPM/ $^{\circ}\text{C}$	
	HP05: $10\text{m}\Omega \leq R \leq 15\text{m}\Omega$: ± 800 ppm/ $^{\circ}\text{C}$ $15\text{m}\Omega < R \leq 25\text{m}\Omega$: ± 600 ppm/ $^{\circ}\text{C}$ $25\text{m}\Omega < R \leq 50\text{m}\Omega$: ± 400 ppm/ $^{\circ}\text{C}$ $50\text{m}\Omega < R < 0.1\Omega$: ± 200 ppm/ $^{\circ}\text{C}$ $0.1\Omega \leq R \leq 10\text{M}$: ± 100 ppm/ $^{\circ}\text{C}$	
	HP06: $10\text{m}\Omega \leq R < 15\text{m}\Omega$: ± 700 ppm/ $^{\circ}\text{C}$ $15\text{m}\Omega \leq R < 30\text{m}\Omega$: ± 400 ppm/ $^{\circ}\text{C}$ $30\text{m}\Omega \leq R < 50\text{m}\Omega$: ± 300 ppm/ $^{\circ}\text{C}$ $50\text{m}\Omega \leq R < 0.1\Omega$: ± 150 ppm/ $^{\circ}\text{C}$ $0.1\Omega \leq R \leq 10\text{M}$: ± 100 ppm/ $^{\circ}\text{C}$	
	HP10: $10\text{m}\Omega \leq R < 15\text{m}\Omega$: 0~+800 ppm/ $^{\circ}\text{C}$ $15\text{m}\Omega \leq R < 50\text{m}\Omega$: 0~+600 ppm/ $^{\circ}\text{C}$ $50\text{m}\Omega \leq R < 10\text{M}$: ± 100 ppm/ $^{\circ}\text{C}$	
	HP12: $10\text{m}\Omega \leq R < 20\text{m}\Omega$: 0~+800ppm/ $^{\circ}\text{C}$ $20\text{m}\Omega \leq R \leq 50\text{m}\Omega$: 0~+400ppm/ $^{\circ}\text{C}$ $50\text{m}\Omega < R \leq 10\text{M}$: ± 75 ppm/ $^{\circ}\text{C}$	
	HP07、HP11: ± 100 PPM/ $^{\circ}\text{C}$	

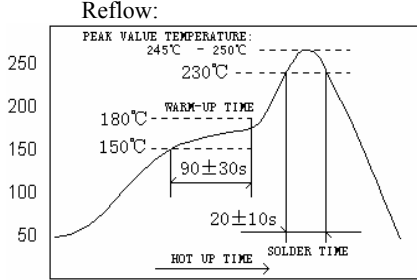
Short-time overload	$\pm 5\%$	$\pm(2.0\%+0.1\Omega)$	4.13 Permanent resistance change after the application of 2.5 times RCWV for 5 seconds.
	$\pm 1\%$	$\pm(1.0\%+0.1\Omega)$	
Dielectric withstanding voltage	No evidence of flashover mechanical damage, arcing or insulation breaks done.		4.7 Clamped in the trough of a 90°C metallic v-block and shall be tested at ac potential respectively specified in the type for 60-70 seconds
Terminal bending	$\pm(1.0\%+0.05\Omega)$ Max		4.33 Twist of test board: Y/X = 3/90 mm for 60seconds
Soldering heat	Resistance change rate must be in $\pm(1.0\%+0.05\Omega)$ Max		4.18 Dipping the resistor into a solder bath having a temperature of 260°C \pm 5°C and hold it for 10 \pm 1 seconds
Solderability	Coverage must be over 95%.		Wave solder: Test temperature of solder: 245°C \pm 3°C dipping time in solder: 2-3 seconds.
			Reflow: 
Rapid change of temperature	$\pm 5\%$	$\pm(1.0\%+0.1\Omega)$	4.19 30 min at lower limit temperature and 30 min at upper limit temperature , 100 cycles..
	$\pm 1\%$	$\pm(0.5\%+0.1\Omega)$	
Humidity (steady state)	$\pm 5\%$	$\pm(3.0\%+0.1\Omega)$	4.24 Temporary resistance change after 240 hours exposure in a humidity test chamber controlled at 40 \pm 2°C and 90-95% relative humidity,
	$\pm 1\%$	$\pm(0.5\%+0.1\Omega)$	
Load life in humidity	$\pm 5\%$	$\pm(3.0\%+0.1\Omega)$	7.9 Resistance change after 1,000 hours (1.5 hours "ON", 0.5 hour "OFF") at RCWV in a humidity chamber controlled at 40°C \pm 2°C and 90 to 95% relative humidity.
	$\pm 1\%$	$\pm(1.0\%+0.1\Omega)$	
Load life	$\pm 5\%$	$\pm(3.0\%+0.1\Omega)$	4.25.1 Permanent resistance change after 1,000 hours operating at RCWV with duty cycle 1.5 hours "ON", 0.5 hour "OFF" at 70°C \pm 2°C ambient.
	$\pm 1\%$	$\pm(1.0\%+0.1\Omega)$	
Low Temperature Storage	$\pm 5\%$	$\pm(3.0\%+0.1\Omega)$	4.23.4 Lower limit temperature , for 2H.
	$\pm 1\%$	$\pm(1.0\%+0.1\Omega)$	
High Temperature Exposure	$\pm 5\%$	$\pm(3.0\%+0.1\Omega)$	4.23.2 Upper limit temperature , for 16H.
	$\pm 1\%$	$\pm(1.0\%+0.1\Omega)$	
Leaching	No visible damage		J-STD-002 Test D Samples completely immersed for 30 sec in solder bath at 260°C.

10. Packing of Surface Mount Resistors

10.1 Dimension of Paper Taping :(Unit: mm)

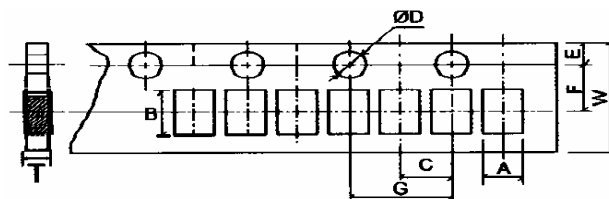

Type	A ± 0.1	B ± 0.1	C ± 0.05	$\begin{matrix} +0.1 \\ \Phi D \\ -0 \end{matrix}$	E ± 0.1	F ± 0.05	G ± 0.1	W ± 0.2	T ± 0.05
HP02	0.65	1.20	2.00	1.50	1.75	3.5	4.00	8.0	0.42

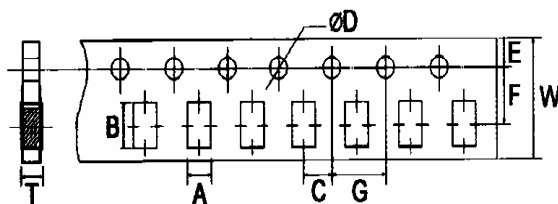

TYPE	A ±0.2	B ±0.2	C ±0.05	+0.1 φD -0	E ±0.1	F ±0.05	G ±0.1	W ±0.2	T ±0.10
HP03	1.10	1.90	2.00	1.50	1.75	3.5	4.00	8.00	0.67
HP05	1.65	2.40	2.00	1.50	1.75	3.5	4.00	8.00	0.81
HP06	2.00	3.60	2.00	1.50	1.75	3.5	4.00	8.00	0.81
HP07	2.80	3.50	2.00	1.50	1.75	3.5	4.00	8.00	0.75

10.2 Dimension of Embossed Taping: (Unit: mm)

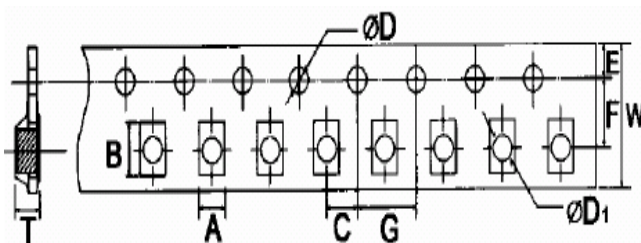

Type	A ±0.2	B ±0.2	C ±0.05	+0.1 φD -0	+0.25 φD1 -0	E ±0.1	F ±0.05	G ±0.1	W ±0.2	T ±0.1
HP10	2.9	5.6	2.0	1.5	1.5	1.75	5.5	4.0	12.0	1.0
HP11	3.5	4.8	2.0	1.5	1.5	1.75	5.5	4.0	12.0	1.0
HP12	3.5	6.7	2.0	1.5	1.5	1.75	5.5	4.0	12.0	1.0

10.2 Dimension of Reel : (Unit: mm)

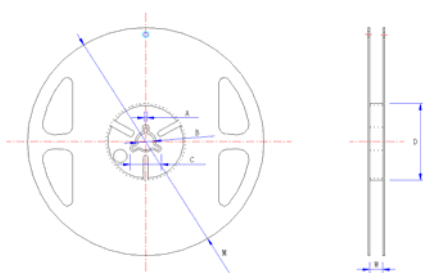

Type	Taping	Size	A±0.5	B±0.5	C±0.5	φD±1	φL±2	W±1
HP02	Paper	10,000pcs reel	2.0	13.0	21.0	60.0	178.0	10.0
HP03	Paper	5,000pcs reel	2.0	13.0	21.0	60.0	178.0	10.0
HP05	Paper	5,000pcs reel	2.0	13.0	21.0	60.0	178.0	10.0
HP06	Paper	5,000pcs reel	2.0	13.0	21.0	60.0	178.0	10.0
HP07	Paper	5,000pcs reel	2.0	13.0	21.0	60.0	178.0	10.0
HP10	Embossed	4,000pcs reel	2.0	13.0	21.0	60.0	178.0	13.8
HP11	Embossed	4,000pcs reel	2.0	13.0	21.0	60.0	178.0	13.8
HP12	Embossed	4,000pcs reel	2.0	13.0	21.0	60.0	178.0	13.8

11. Note

- 11.1. UNI-ROYAL recommend the storage condition temperature: 15°C~35°C, humidity :25%~75%.
(Put condition for individual product).Even under UNI-ROYAL recommended storage condition, solderability of products over 1 year old.
(Put condition for each product) may be degraded.
- 11.2. Store / transport cartons in the correct direction, which is indicated on a carton as a symbol.
Otherwise bent leads may occur due to excessive stress applied when dropping of a carton.
- 11.3. Product performance and soldered connections may deteriorate if the products are stored in the following places:
- Storage in high Electrostatic.
 - Storage in direct sunshine 、rain and snow or condensation.
 - Where the products are exposed to sea winds or corrosive gases, including Cl₂, H₂S₃, NH₃, SO₂, NO₂.

12. Record

Version	Description of amendment	Page	Date	Amended by	Checked by
1	First issue of this specification	1~8	Mar.20, 2018	Chen Haiyan	Chen Nana
2	Modify the Performance Specification	5~6	Feb.12, 2019	Chen Haiyan	Xu Yuhua

Uniroyal Electronics Global Co., Ltd. , all rights reserved. Spec. herein would be changed at any time without prior notice.

X-ON Electronics

Largest Supplier of Electrical and Electronic Components

Click to view similar products for [Thick Film Resistors](#) category:

Click to view products by [Uniroyal](#) manufacturer:

Other Similar products are found below :

[MCR03EZPFX3162](#) [MCR004YZPJ332](#) [201007J022KT4E](#) [201007F1653T4E](#) [201007F6652T4E](#) [0603WAF137KT5E](#) [RTT204702FTE](#)
[RTT203000FTE](#) [RTT2056R0FTE](#) [CR2010F470KE04Z](#) [RTT018451FTH](#) [RTT021802DTH](#) [0402WGF510LTCE](#) [0201WMJ0200TEE](#)
[TR0603B26K7P0550Z](#) [0201WMF5102TEE](#) [1210W2J047KT5E](#) [YLR12-2-4F-W](#) [HOT\(0.25x1.3\)-3.2-0R-I](#) [HOT\(0.4x1.5\)-5.2-0R-I](#)
[HoT\(0.45x1.5\)-8.2-0R-I](#) [0201WMF1103TEE](#) [0201WMF7152TEE](#) [1210W2J0124T5E](#) [201007J010LT4E](#) [201007J0360T4E](#) [201007J0430T4E](#)
[0805W8F931KT5E](#) [1206W4F5231T5E](#) [1210W2J0620T5E](#) [201007J0822T4E](#) [0201WMF1005TCE](#) [0201WMF1212TCE](#) [0201WMF1373TCE](#)
[0201WMF1400TCE](#) [0201WMF2000TEE](#) [0201WMF2001TCE](#) [0201WMF226JTCE](#) [0201WMF2672TCE](#) [0201WMF2803TCE](#)
[0201WMF357JTCE](#) [0201WMF3743TCE](#) [0201WMF430JTCE](#) [0201WMF4990TCE](#) [0201WMF5104TCE](#) [0201WMF510JTEE](#)
[0201WMF5110TCE](#) [0201WMF6652TEE](#) [0201WMF6812TCE](#) [0201WMF8200TCE](#)