



**UNI-ROYAL**  
厚聲集團

# DATA SHEET

**Product Name** Metal Strip Chip Resistors

---

**Part Name** LR Series

## **Uniroyal Electronics Global Co., Ltd.**

88#, Longteng Road, Economic & Technical Development Zone, Kunshan, Jiangsu, China

Tel +86 512 5763 1411 / 22 /33

Email [marketing@uni-royal.cn](mailto:marketing@uni-royal.cn)

Manufacture Plant Uniroyal Electronics Industry Co., Ltd.

Aeon Technology Corporation

Royal Electronic Factory (Thailand) Co., Ltd.

Royal Technology (Thailand) Co., Ltd.

## 1. Scope

- 1.1 This specification for approve relates to the Metal Strip Chip Resistors manufactured by UNI-ROYAL.
- 1.2 Low Resistance / Low TCR
- 1.3 Excellent long term stability
- 1.4 RoHs compliant and halogen free.
- 1.5 Lead free.
- 1.6 High precision current sensing and voltage division.

## 2. Part No. System

Part No. includes 14 codes shown as below:

2.1 1st~4th codes: Part name. E.g.: LR05, LR06, LR12, LR25, LR28, LR27

2.2 5th~6th codes: Power rating.

E.g.: W=Normal Size		“1~G” = “1~16”								
Wattage	1/32	3/4	1/2	1/3	1/4	1/8	1/10	1/16	1/20	1
Normal Size	WH	07	W2	W3	W4	W8	WA	WG	WM	1W

If power rating is lower or equal than 1 watt, 5<sup>th</sup> code would be “W” and 6<sup>th</sup> code would be a number or letter.

E.g.: 1W=1W      4W=4W

2.3 7<sup>th</sup> code: Tolerance. E.g.: D=±0.5%      F=±1%      G=±2%      J=±5%      K=±10%

2.4 8<sup>th</sup>~11<sup>th</sup> codes: Resistance Value.

2.4.1 If value belongs to standard value of ≥5% series, 8<sup>th</sup> code would be zero, 9<sup>th</sup>~10<sup>th</sup> codes are significant figures of the resistance and 11<sup>th</sup> code is the power of ten.

2.4.2 If value belongs to standard value of ≤2% series, 8<sup>th</sup>~10<sup>th</sup> codes are significant figures of the resistance, and 11<sup>th</sup> code is the power of ten.

2.4.3 11<sup>th</sup> codes listed as following:

0=10<sup>0</sup>    1=10<sup>1</sup>    2=10<sup>2</sup>    3=10<sup>3</sup>    4=10<sup>4</sup>    5=10<sup>5</sup>    6=10<sup>6</sup>    J=10<sup>-1</sup>    K=10<sup>-2</sup>    L=10<sup>-3</sup>    M=10<sup>-4</sup>  
 N=10<sup>-5</sup>    P=10<sup>-6</sup>

2.5 12<sup>th</sup>~14<sup>th</sup> codes.

2.5.1 12<sup>th</sup> code: Packaging Type. E.g.: C=Bulk      T=Tape/Reel

2.5.2 13<sup>th</sup> code: Standard Packing Quantity.

4=4000pcs    5=5000pcs    C=10000pcs    D=20000pcs    E=15000pcs  
 Chip Product:    BD=B/B-20000pcs      TC=T/R-10000pcs

2.5.3 14<sup>th</sup> code: Special features.

E = Environmental Protection, Lead Free, or Standard type.

## 3. Ordering Procedure

(Example: LR06 1W ±1% 1mΩ T/R-5000)

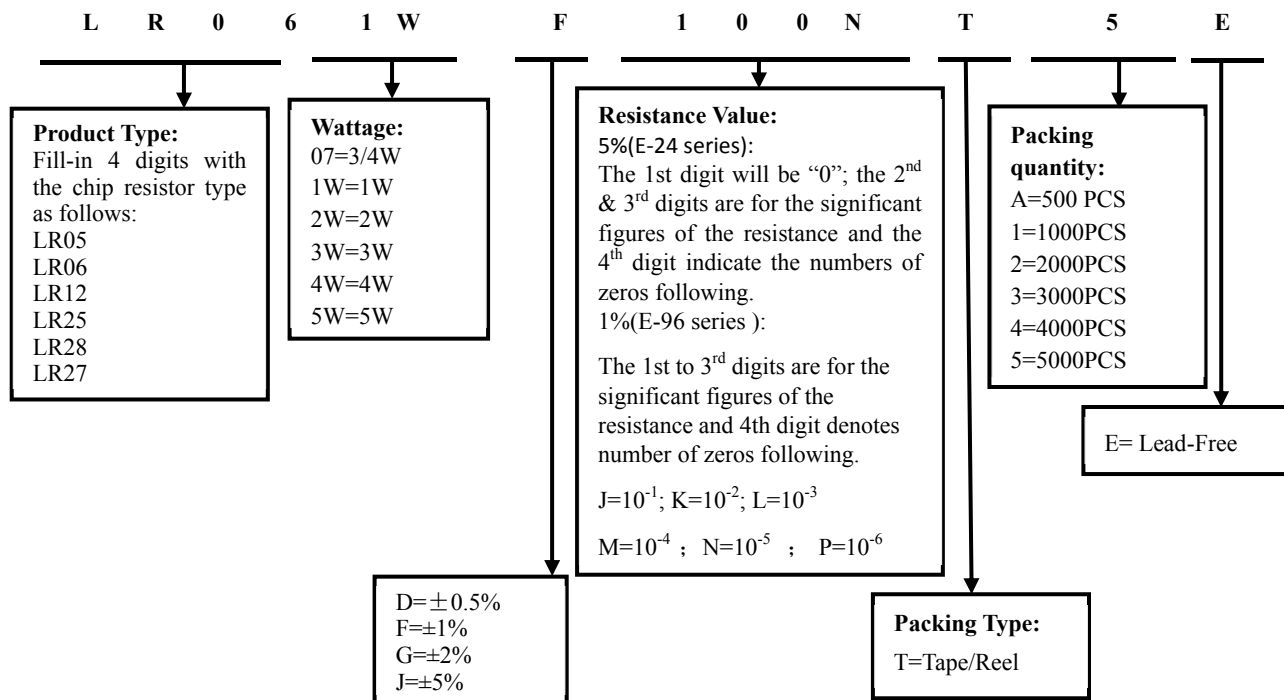

#### 4. Marking

4.1 LR05 products no marking.

4.2 All the other products marking are 4 digits.

(1) "R" designates the decimal location in ohms

e.g. 1mΩ the product marking is R001.

25mΩ the product marking is R025.

100mΩ the product marking is R100.

(2) 0Ω product marking is 0R

4.3 The criteria to distinguishing the mark on the surface of products are that characters can be identified.

#### 5. Standard Electrical Specifications

Type	Rating Power at 70°C	T.C.R. (ppm/°C)	Max. Rating Current (A)	Max. Overload Current (A)	Resistance Range (mΩ)			Operating Temperature Range (°C)
					0.5% (D)	1.0% (F) 2.0% (G) 5.0% (J)		
LR05	1W	≅±100	31.62	63.24	---	1	-55~+170°C	
		≅±75	25.81	44.72	---	1.5~2		
		≅±50	15.81	31.62	---	2.5~15		
LR06	1W	≅±50	31.62	63.24	7~50	1~50		
	1.5W	≅±50	38.72	77.49	7~10	1~10		
LR12	2W	≅±75	63.24	141.42	---	0.5~0.75		
	2W	≅±50	44.72	100.00	16~450	1~450		
	3W	≅±75	77.45	154.91	---	0.5~0.75		
	3W	≅±50	54.77	109.54	7~100	1~100		
LR25	4W	≅±75	126.49	252.98	---	0.25~0.3		
		≅±50	89.44	178.88		0.5~3		
LR28	4W	≅±50	31.62	63.24	7~450	4~450		
LR27	3W	≅±75	77.45	173.20	---	0.5		
	3W	≅±50	54.77	122.47	7~60	1~60		
	5W	≅±75	100.00	173.20	---	0.5		
	5W	≅±50	70.71	122.47	7~500	1~500		

#### Jumper Specifications

Type	Rating Power at 70°C	Max. Rating Current	Resistance (mΩ)	Operating Temperature Range (°C)
LR05	1W	70.7A	≅0.2	-55~+170°C
LR06	1W	70.7A		
LR12	2W	100A		

**6. Dimension**

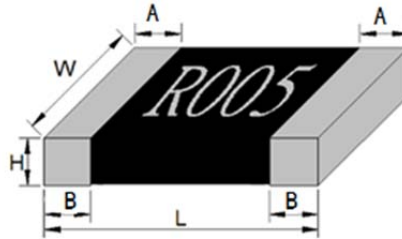

Unit:mm

Type	Power Rating	Resistance Range	L	W	H	A	B
LR05	1W	1mΩ	2.100±0.200	1.500±0.200	0.500±0.200	/	0.400±0.200
		1.5mΩ			0.350±0.200		
		2mΩ					
		2.5~3mΩ					
		4~8mΩ					
		9~15mΩ					
LR06	1W	1mΩ	3.200±0.254	1.650±0.254	0.770±0.254	0.508±0.254	0.508±0.254
		2mΩ			0.650±0.254		
		3~20mΩ			0.550±0.254		
		21~50mΩ			0.470±0.254		
	1.5W	1mΩ			0.770±0.254		
		2mΩ			0.650±0.254		
		3~10mΩ			0.550±0.254		
LR12	2W	0.5mΩ	6.35±0.254	3.18±0.254	0.770±0.254	1.150±0.254	2.200±0.254
		1 mΩ			0.700±0.200	1.800±0.200	1.800±0.200
		2~15mΩ				0.900±0.200	0.900±0.200
		16~75mΩ			0.600±0.254	1.05±0.254	1.100±0.254
		76~100mΩ			0.550±0.254	0.75±0.254	
		101~135mΩ			0.470±0.254		
		136~200mΩ			0.400±0.254		
		201~450mΩ				0.850±0.254	
	3W	0.5mΩ			0.770±0.254	1.150±0.254	2.200±0.254
		1mΩ			0.670±0.254	1.150±0.254	1.400±0.254
		1.5mΩ					1.150±0.254
		2mΩ					
		2.5~6mΩ			0.550±0.254	0.75±0.254	1.100±0.254
		7~75mΩ			0.600±0.254		
76~100mΩ	0.550±0.254						
LR25	4W	0.25mΩ	6.800±0.254	6.350±0.254	0.770±0.254	1.15±0.254	2.300±0.254
		0.3mΩ					1.800±0.254
		0.5mΩ					2.300±0.254
		1mΩ			0.650±0.254		1.800±0.254
		1.5mΩ					1.500±0.254
		2~3mΩ			0.550±0.254		
LR28	4W	4~450mΩ	6.600±0.254	6.700±0.254	0.580±0.254	0.40±0.254	1.050±0.254
LR27	3W	0.5mΩ	11.300±0.500	6.600±0.500	0.770±0.254	0.90±0.254	3.000±0.254
		1mΩ					2.000±0.254
		1.5~5mΩ			0.650±0.254		
		6~60mΩ			0.550±0.254		
	5W	0.5mΩ			0.800±0.254	0.65±0.254	3.000±0.254
		1mΩ			0.680±0.254		2.000±0.254
		1.5~5mΩ					
		6~500mΩ			0.580±0.254		

**JumperDimension**

Unit:mm							
Type	Power Rating	Resistance Range	L	W	H	A	B
LR05	1W	< 0.2mΩ	2.10±0.20	1.500±0.20	0.35±0.20	/	0.40±0.20
LR06	1W	< 0.2mΩ	3.200±0.250	1.650±0.250	0.650±0.254	0.508±0.254	0.508±0.254
LR12	2W	< 0.2mΩ	6.350±0.250	3.180±0.250	0.650±0.254	1.15±0.254	1.100±0.254

**7. Structure**

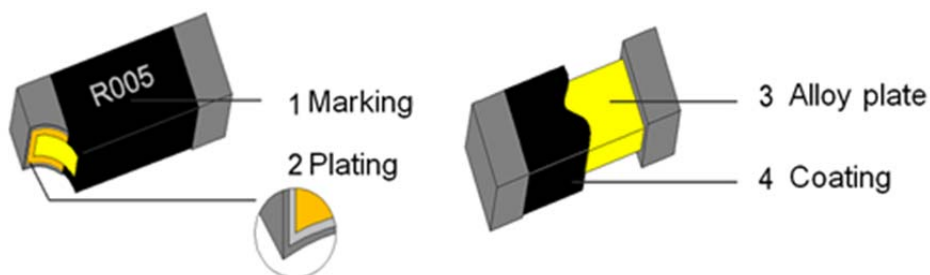

**8. Recommend land pattern**

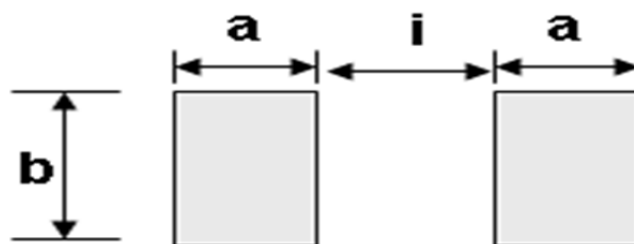

Unit: mm				
Type	Resistance Range	a	b	i
LR05-1W	1~15mΩ	1.00	1.80	1.00
LR06 -1W,1.5W	Jumper : ≅0.2mΩ	1.46	2.15	1.68
	1mΩ~100mΩ	1.46	2.15	1.68
LR12 -2W	Jumper : ≅0.2mΩ	2.30	3.68	3.15
	0.5mΩ	3.40	3.68	0.95
	1mΩ~15mΩ	1.90	3.68	3.50
	16mΩ~200mΩ	2.30	3.68	3.15
LR12 3W	201mΩ~500mΩ	2.05	3.68	3.65
	0.5mΩ~1mΩ	3.40	3.68	0.95
	1.5mΩ	2.35	3.68	1.35
	2mΩ	2.10	3.68	2.55
LR25 - 4W	2.5mΩ~100mΩ	2.30	3.68	3.15
	0.25mΩ ; 0.5mΩ	3.25	6.85	1.70
LR28 - 4W	0.3mΩ ; 1mΩ~3mΩ	2.75	6.85	2.70
	4mΩ~450mΩ	2.05	7.20	3.90
LR27-,3W,5W	0.5mΩ~1.5mΩ	4.50	8.74	4.50
	2.0mΩ~100mΩ	3.50	8.74	6.50
	101mΩ~500mΩ	3.50	8.74	6.50

## 9. Derating Curve

Resistors shall have a power rating based on continuous load operation at an ambient temperature of 70 °C. For temperature in excess of 70 °C, The load shall be derate as shown in figure 1.

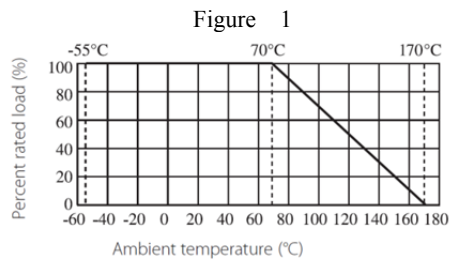

The following equation may be used to determine the DC (Direct Current) or AC (Alternating Current) (RMS, root mean square value) of normal rated power. However, if the result value exceeds the highest current of regulated standards, the highest normal rated power is to be used

$$I = \sqrt{P \div R}$$

I = Rating current (A)

P= Rating Power (W)

R= Resistance(Ω)

## 10. Performance Specification

Test Item	Test Method	Procedure	Requirements
Temperature Coefficient	JIS C 5201-1 4.8	Natural resistance changes per temp. Degree centigrade $\frac{R_2 - R_1}{R_1(t_2 - t_1)} \times 10^6 \text{ (PPM/°C)}$ R1: resistance value at room temp. (t <sub>1</sub> ) R2: resistance value at room temp. +100°C (t <sub>2</sub> ) Test pattern: room temp. (T <sub>1</sub> ), room temp. +100°C(t <sub>2</sub> )	List by specification
Short-time overload	JIS-C-5201 4.13	Permanent resistance change after the application of a potential of 5 times power rate for 5 seconds	$\Delta R \leq \pm 0.5\%$
Operational Life	JIS-C-5201 4.25.1	Permanent Resistance change after 1000 hours operating at rated working current or Max .Working Current whichever less with duty cycle of 1.5hours “ON” , 0.5 hour “OFF” at 70±2°C ambient.	$\Delta R \leq \pm 1.0\%$
High Temp. Exposure	MIL-STD-202 108A	Exposed to a temperature of 170±2°C for 1000H.	$\Delta R \leq \pm 1.0\%$
Biased Humidity	MIL-STD-202 Method 103	1000 hours 85°C/85%RH. Note: Specified conditions:10% of operating power. Measurement at 24±4 hours after test conclusion.	$\Delta R \leq \pm 0.5\%$
Rapid change of temperature	JIS-C-5201 4.19	30 min at -55 °C and 30 min at 170°C; 100 cycles	$\Delta R \leq \pm 0.5\%$
Terminal bending	JIS-C-5201 4.33	2mm , 60Sec	$\Delta R \leq \pm 0.50\%$
Resistance to Solder Heat	JIS-C-5201 4.18	Dip the resistor into a temperature of 260±5°C and hold it for a 10±1 seconds.	$\Delta R \leq \pm 0.5\%$
Solderability	JIS-C-5201 4.17	The area covered with a new, smooth, clean, shiny and continuous surface free from concentrated pinholes. Temperature of solder: 245±3°C; Dwell time in solder: 2~3 seconds.	>95% Coverage
Dielectric Withstanding Voltage	JIS-C-5201 4.7	Applied 500 VAC for 1 minute , and Limit surge current 50 mA (max.)	No short or burned on the appearance
Terminal Strength	JIS-C-5201 4.16	5N , 10 seconds	No broken

For Jumper

Test Item	Test Method	Procedure	Requirements
Short Time Overload	JIS C 5201-1 4.13	Permanent resistance change after the application of a potential of 4 times power rate for 5 seconds	$\cong 0.2m\Omega$
Temperature Cycling	JIS-C-5201 4.19	30 min at -55 °C and 30 min at 170°C; 100 cycles	$\cong 0.2m\Omega$
High Temperature Exposure	MIL-STD-202 108A	Exposed to a temperature of 170±2°C for 1000H.	$\cong 0.2m\Omega$
Bias Humidity	MIL-STD-202 Method 103	1000 hours 85°C/85%RH. Note: Specified conditions:10% of operating power . Measurement at 24±4 hours after test conclusion.	$\cong 0.2m\Omega$
Operational Life	JIS C 5201-1 4.25	Permanent Resistance change after 1000 hours operating at rated working current or Max .Working Current whichever less with duty cycle of 1.5hours “ON” · 0.5 hour “OFF” at 70±2°C ambient.	$\cong 0.2m\Omega$
Solderability	JIS-C-5201 4.17	The area covered with a new, smooth, clean, shiny and continuous surface free from concentrated pinholes. Temperature of solder : 245±3°C; Dwell time in solder: 2~3 seconds.	>95% coverage

11. Soldering Profile

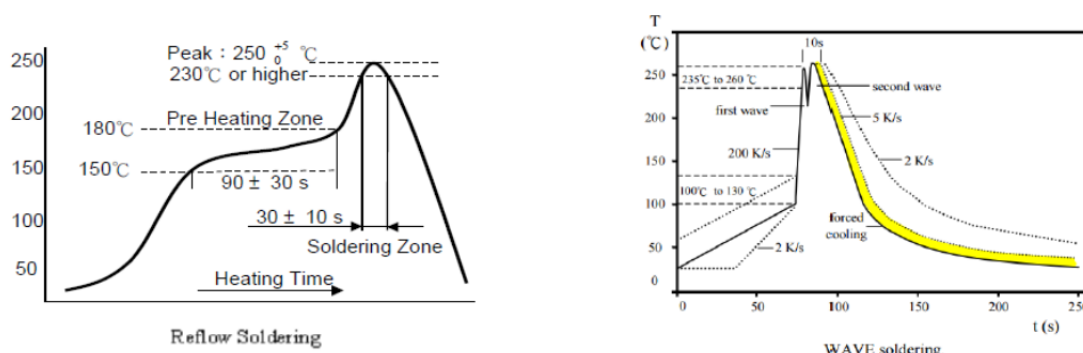

12. Packing of Surface Mount Resistors

12.1 Embossed Dimensions:(Unit: mm)

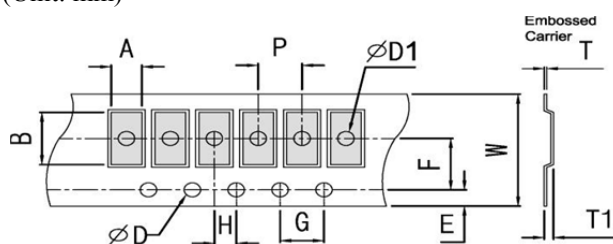

Type	Resistance Range	W	P	E	F	$\phi D$	$\phi D1$	G	H	A	B	T1	T	
LR05	1~15m $\Omega$	8.0±0.30	4.0±0.10	1.75±0.10	3.5±0.10	1.50 $^{+0.1}$ <sub>0</sub>	1.0±0.10	4.0±0.10	2.0±0.10	2.03±0.10	3.55±0.10	0.80±0.20	0.20±0.05	
LR06	1m $\Omega$	8.0±0.30	4.0±0.10	1.75±0.10	3.5±0.10		1.0±0.10	4.0±0.10	2.0±0.10	2.03±0.10	3.55±0.10	1.10±0.10	0.85±0.10	0.20±0.05
	2~100m $\Omega$						1.10±0.10							
LR12	0.5m $\Omega$	12.0±0.30	4.0±0.10	1.75±0.10	5.5±0.10		1.55±0.10	4.0±0.10	2.0±0.10	3.50±0.10	6.80±0.10	1.10±0.10	0.90±0.10	0.20±0.05
	1~500m $\Omega$						1.10±0.10							
LR25	0.25~3m $\Omega$	12.0±0.30	8.0±0.10	1.75±0.10	5.5±0.10		1.55±0.10	4.0±0.10	2.0±0.10	6.81±0.10	7.16±0.10	1.05±0.10	0.25±0.05	
LR28	4~450m $\Omega$	12.0±0.30	8.0±0.10	1.75±0.10	5.5±0.10		1.55±0.10	4.0±0.10	2.0±0.10	7.10±0.10	7.05±0.10	0.95±0.10	0.20±0.05	
LR27	0.5~500m $\Omega$	24.0±0.30	12.0±0.10	1.75±0.10	11.5±0.10	1.50±0.10	4.0±0.10	2.0±0.10	7.38±0.10	12.0±0.10	1.05±0.10	0.30±0.10		

## 12.2 Dimension of Reel : (Unit: mm)

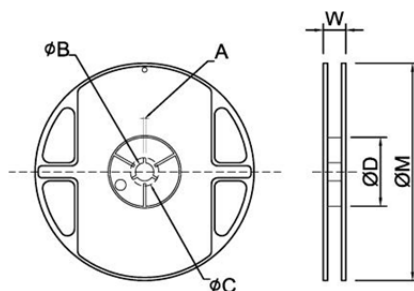

Type	Taping	Qty/Reel	A	ΦB	ΦC	ΦD	W	ΦM
LR05	Embossed	5,000pcs	2.0±0.5	13.0±0.5	21.0±0.5	60.0±1.0	10.0±1.0	178±2.0
LR06	Embossed	5,000pcs	2.0±0.5	13.0±0.5	21.0±0.5	60.0±1.0	10.0±1.0	178±2.0
LR12	Embossed	4,000pcs	2.0±0.5	13.0±0.5	21.0±0.5	60.0±1.0	13.8±1.0	178±2.0
LR25	Embossed	2,000pcs 1,000pcs	2.5±0.5	13.5±0.5	17.7±0.5	60.0±1.0	16.2±1.0	178±2.0
LR28	Embossed	2,000pcs 1,000pcs	2.5±0.5	13.5±0.5	17.7±0.5	60.0±1.0	16.2±1.0	178±2.0
LR27	Embossed	1,000pcs 500pcs	2.0±0.5	13.2±0.5	17.7±0.5	60.0±1.0	24.4±2.0	178±2.0

### 13. Note

13.1 UNI-ROYAL recommend the storage condition temperature:  $25 \pm 5^{\circ}\text{C}$ , humidity :  $60 \pm 20\%$ .

(Put condition for individual product).

Even under UNI-ROYAL recommended storage condition, solderability of products over 1 year old. (Put condition for each product) may be degraded.

13.2 Store / transport cartons in the correct direction, which is indicated on a carton as a symbol.

Otherwise bent leads may occur due to excessive stress applied when dropping of a carton.

13.3 Product performance and soldered connections may deteriorate if the products are stored in the following places:

- a. Storage in high Electrostatic.
- b. Storage in direct sunshine、rain and snow or condensation.
- c. Where the products are exposed to sea winds or corrosive gases, including  $\text{Cl}_2$ ,  $\text{H}_2\text{S}$ ,  $\text{NH}_3$ ,  $\text{SO}_2$ ,  $\text{NO}_2$ .

### 14. Record

Version	Description	Page	Date	Amended by	Checked by
1	First version	1~8	Apr.02, 2020	Haiyan Chen	Yuhua Xu



## X-ON Electronics

Largest Supplier of Electrical and Electronic Components

*Click to view similar products for [Current Sense Resistors - SMD category](#):*

*Click to view products by [Uniroyal manufacturer](#):*

Other Similar products are found below :

[CRL0603-FW-R700ELF](#) [PFS35-200RF1](#) [CD2015FC-0.10-1%](#) [PR2512FKF7W0R004L](#) [RC1005F124CS](#) [CSNL2512FT5L00](#)

[RL73K3AR56JTDF](#) [RL7520WT-R001-F](#) [RL7520WT-R020-F](#) [LRC-LR2512LF-01-R820J](#) [65709-330](#) [SP1R12J](#) [RL7520WT-R039-G](#)

[RL7520WT-R002-F](#) [RL7520WT-R005-F](#) [KRL1632E-C-R200-F-T5](#) [KRL1632E-C-R200-F-T1](#) [Y14880R02000B9R](#) [RLP73M2AR075FTDF](#)

[SR731ERTTP5R10F](#) [SR731ERTTP100J](#) [SR731ERTTP6R80F](#) [SR731ERTTP3R9J](#) [SR731ERTTP8R2J](#) [SR731ERTTP2R0J](#)

[SR731ERTTP4R7J](#) [SR731ERTTP9R1J](#) [SR731ERTTP1R0J](#) [SR731ERTTP2R2J](#) [SR731ERTTP5R1J](#) [SR731ERTTP6R8J](#) [SR731ERTTP9R10F](#)

[FCSL64R007JER](#) [73L4R10G](#) [73L4R75G](#) [73L4R33G](#) [73M1R051F](#) [73WL4R020J](#) [73L2R68J](#) [73L2R22J](#) [73L2R33J](#) [CC1512FC-0.015-5%](#)

[ULRG2-2512-R0075-F-LF-SLT](#) [KDV08DR220ET](#) [KDV12DR240ET](#) [SLN3TTED80L6F](#) [JW104X15X4](#) [JW105X19X5](#) [HVR06FTEV2403](#)

[JW104X5X4](#)