

厚 聲 電 子 工 業 有 限 公 司

UNIROYAL ELECTRONICS INDUSTRY CO., LTD.



ISO14001



ISO/TS16949



244546



245468



REG.-Nr.A759



CQC04001010656



Specification for Approval

Customer : 深圳市立创电子商务有限公司

Product Name : LEAD-FREE METAL FILM FIXED RESISTORS

Part Name : MFR SERIES $\pm 0.1\%$ ± 0.25 $\pm 0.5\%$ $\pm 1\%$ 、 $\pm 2\%$ 、 $\pm 5\%$

Part No. : MFRO*****0

88 Longteng Road, Economic & Technical Development Zone, Kunshan City, Jiangsu, CHINA 215334

TEL: 86 512 57631411 / 22 / 33

FAX: 86 512 57631431

E-mail: globalsales@uniohm.com localsales@uniohm.com

Approved	Checked	Prepared	File NO.	Edition	Date	Page
William Zhao	Apple Liu	Wu Yiyun	JLC-01-008	1	2016/5/9	1/13



ISO14001



ISO/TS16949



244546



245468



REG.-Nr.A759



CQC04001010658

Content

Index.....	Page
1.0 Scope.....	4
2.0 Ratings and dimension.....	4
3.0 Structure.....	5
4.0 Mark.....	5
5.0 Derating curve.....	6
6.0 Voltage rating.....	6
7.0 Specification.....	7
8.0 Explanation of Part No. System.....	8
9.0 Order procedure.....	9
10.0 Standard packing.....	10
11.0 Note.....	13

Approved	Checked	Prepared	File NO.	Edition	Date	Page
William Zhao	Apple Liu	Wu Yiyun	JLC-01-008	1	2016/5/9	2/13

厚 聲 電 子 工 業 有 限 公 司

UNIROYAL ELECTRONICS INDUSTRY CO., LTD.



ISO14001



ISO/TS16949



244546



245468



REG.-Nr.A759



CQC04001010656

File Name: MFR SERIES		Date	2016/5/9	Edition No.	1
Amendment Record				Signature	
Edition	Description	Page	Date	Amended by	Checked by

Approved	Checked	Prepared	File NO.	Edition	Date	Page
William Zhao	Apple Liu	Wu Yiyun	JLC-01-008	1	2016/5/9	3/13



ISO14001

ISO/TS16949

244546

245468

REG.-Nr.A759

CQC04001610656

1.0 Scope

This file is the specification for Lead-Free Metal Film Fixed Resistors manufactured by UNIOHM.

2.0 Ratings and dimensions

For 1/8W, 1/4WS, 0.4WSS



Other

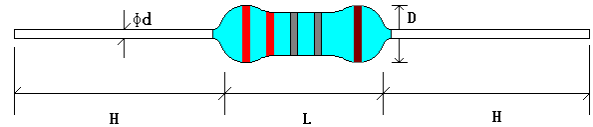

2.1 Normal size

Type	Dimension(mm)				Max Working Voltage	Max Overload Voltage	Dielectric Withstanding Voltage	Tolerance	Resistance Range
	D	L	d±0.05	H±3					
MF 1/8W	1.9±0.3	3.3±0.3	0.45	28	200V	400V	400V	±1%、±2%	10Ω~1MΩ
								±5%	1Ω~1MΩ
MF 1/4W	2.2±0.3	6.5±1.0	0.54	28	250V	500V	500V	±1%、±2%	10Ω~1MΩ
								±5%	1Ω~1MΩ
MF 1/2W	3.0±0.6	9.5±1.0	0.54	28	350V	700V	700V	±1%、±2%	10Ω~1MΩ
								±5%	1Ω~1MΩ
MF 1W	4.5±0.6	11.5±1.0	0.65	28	500V	1000V	1000V	±1%、±2%	51.1Ω~1MΩ
								±5%	1Ω~1MΩ
MF 2W	5.0±0.6	15.5±1.0	0.70	28	500V	1000V	1000V	±1%、±2%	51.1Ω~1MΩ
								±5%	1Ω~1MΩ
MF 3W	6.0±0.6	17.5±1.0	0.75	28	500V	1000V	1000V	±1%、±2%	51.1Ω~1MΩ
								±5%	1Ω~1MΩ

2.2 Small Size & ultra Small Size

Type	Dimension(mm)				Max Working Voltage	Max Overload Voltage	Dielectric Withstanding Voltage	Tolerance	Resistance Range
	D	L	d±0.05	H±3					
MF 1/4WS	1.9±0.5	3.3±0.3	0.45	28	200V	400V	200V	±1%、±2%	10Ω~1MΩ
								±5%	1Ω~1MΩ
MF 0.4WSS	1.9±0.5	3.3±0.3	0.45	28	200V	400V	200V	±1%、±2%	10Ω~1MΩ
								±5%	1Ω~1MΩ
MF 1/2WSS	2.2±0.5	6.5±0.5	0.54	28	250V	500V	250V	±1%	10Ω~1MΩ
								±2%、±5%	1Ω~1MΩ
MF 1/2WS	2.7±0.5	9.0±1.0	0.54	28	350V	700V	700V	±1%、±2%	10Ω~1MΩ
								±5%	1Ω~1MΩ
MF 0.6WS	2.2±0.5	6.5±1.0	0.54	28	250V	500V	250V	±1%	10Ω~1MΩ
								±2%、±5%	1Ω~1MΩ
MF 1WS	3.5±0.6	9.5±1.0	0.60	28	350V	700V	350V	±1%、±2%、±5%	10Ω~1MΩ
MF 2WS	4.0±0.6	11.5±1.0	0.65	28	500V	1000V	350V	±1%、±2%、±5%	10Ω~1MΩ
MF 3WS	5.0±0.6	15.5±1.0	0.70	28	500V	1000V	350V	±1%、±2%、±5%	10Ω~1MΩ

Approved	Checked	Prepared	File NO.	Edition	Date	Page
William Zhao	Apple Liu	Wu Yiyun	JLC-01-008	1	2016/5/9	4/13



ISO14001



ISO/TS16949



244546



245468



REG.-Nr.A759



CQC04001610656

3.0 Structure



No.	Name	Material
1	Basic body	Rod type ceramics
2	Resistance layer	Metal Film
3	End cap	Cold steel plated with copper/tin
4	Lead wire	Tin solder coated copper wire
5	Joint	By Welding
6	Coating	1. Inner paint: Celluloid resin 2. Outer paint: 2.1 Inflammable resin for normal size and 1/2W small size: Blue 2.2 Non-inflammable resin for other small size: Light Green 2.3 Non-inflammable resin for ultra-small size-0.4WSS: Deep Green
7	Color bands	Epoxy resin

4.0 Mark

Resistors shall be marked with color bands which in accordance with JIS C 0802

For 1/8W, 1/4WS, 0.4WSS ($\pm 1\%$)

Another

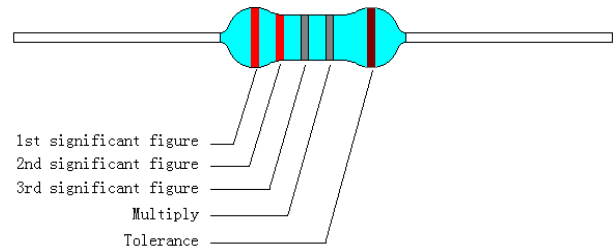
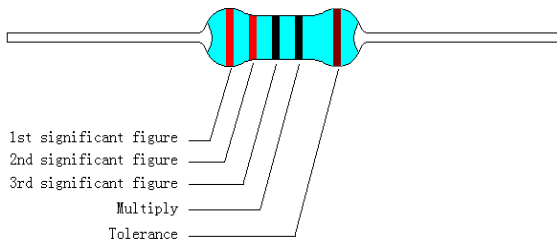

For 1/8W, 1/6W, 1/4WS, 0.4WSS ($\pm 2\%$, $\pm 5\%$)

Another

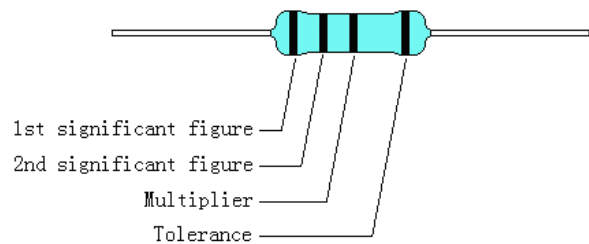
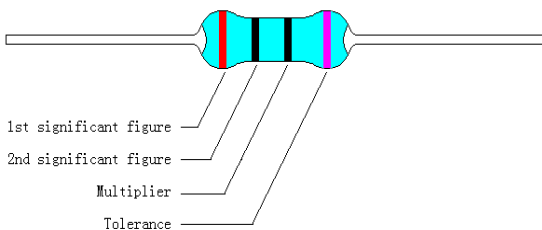

Approved	Checked	Prepared	File NO.	Edition	Date	Page
William Zhao	Apple Liu	Wu Yiyun	JLC-01-008	1	2016/5/9	5/13



4.1 Label: Label includes following items:

- 4.1.1 Type and style
- 4.1.2 Nominal resistance
- 4.1.3 Resistance tolerance
- 4.1.4 Quantity
- 4.1.5 Lot. No.
- 4.1.6 TCR: PPM

Example:

METAL FILM FIXED RESISTORS	
WATT: 2W	VAL: 200KΩ
Q'TY: 1,000	TOL: 1%
LOT: 3021548	PPM: 50

5.0 Derating curve:

Resistors shall have a power rating based on continuous load operation at an ambient temperature from -55°C to 70°C. If temperature is above 70°C, the load shall be derate as shown in figure 1

Figure1

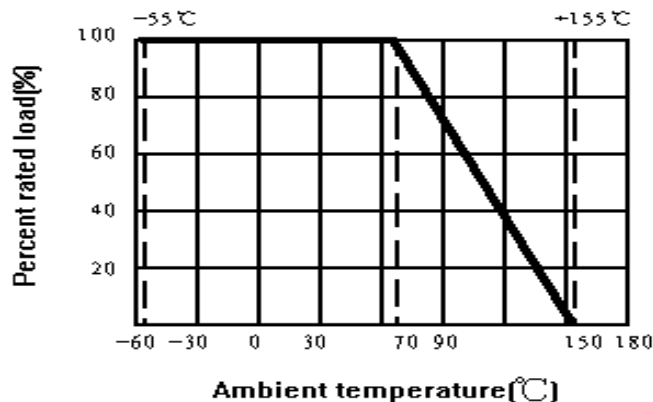

6.0 Voltage rating:

Resistors should have a power rating based on direct-current (DC) continuous voltage rating and an alternating-current (AC) continuous voltage rating which calculating formula shown as below:

$$RCWV = \sqrt{P * R}$$

RCWV: Rated DC or RMS AC continuous working voltage (Volt.)

P: Power Rating (Watt.)

R: Nominal Resistance (Ohm)

Resistors will be burned out if it overload, such as higher than the maximum value of series' RCWV. And we named 2.5 times RCWV is OVERLOAD Voltage.

Approved	Checked	Prepared	File NO.	Edition	Date	Page
William Zhao	Apple Liu	Wu Yiyun	JLC-01-008	1	2016/5/9	6/13



ISO14001

ISO/TS16949

244546

245468

REG.-Nr.A759

CQC94001610656

7.0 Specification

Item	Limits		Test Method (JIS-C-5201&5202)															
Temperature Coefficient	± 0.1%	± 15 PPM/°CMax..	4.8 Natural resistance changes per temp. Degree centigrade $\frac{R_2 - R_1}{R_1(T_2 - T_1)} * 10^6 \text{ (PPM/°C)}$ R1: resistance value at room temp. (T1) R2: resistance value at room temp. +100°C (Tt2) Test pattern: room temp. (T1), room temp. +100°C(T2)															
	± 0.25%	± 25 PPM/°CMax..																
	± 0.5%	± 50PPM/°CMax..																
	±1%	±50PPM/°CMax..																
	±2%	±100PPM/°CMax.																
	±5%	±200PPM/°CMax..																
Short-time overload	Resistance change rate is: ±(0.5%+0.05Ω)Max. With no evidence of mechanical damage.		4.13 Permanent resistance change after the application of a potential of 2.5 times RCWV for 5 seconds.															
Dielectric withstanding voltage	No evidence of flashover mechanical damage, arcing or insulation break down.		4.7 Resistors shall be clamped in the trough of a 90°metallic v-block and shall be tested at ac potential respectively specified in the above list for 60-70 seconds.															
Pulse overload	Resistance change rate is: ± (1%+0.05Ω) Max. With no evidence of mechanical damage.		4.28 Resistance change after 10,000 cycles (1 second "ON ", 25 seconds "OFF ") at 4 times RCWV.															
Resistance to soldering heat	Resistance change rate is: ± (1%+0.05Ω) Max. With no evidence of mechanical damage		4.18 Permanent resistance change when leads immersed to a point 2.0-2.5mm from the body in 260°C±5°C solder for 10±1 seconds.															
Resistance to solvent	No deterioration of protective coatings & markings		4.29 Specimens shall be immersed in a bath of trichloroethylene completely for 3 min. With ultrasonic															
Terminal strength	No evidence of mechanical damage		4.16 Direct load: Resistance to a 2.5 kg direct load for 10 seconds in the direction of the longitudinal axis of the terminal leads. Twist test: Terminal leads shall be bent through 90°at a point of about 6mm from the body of the resistor and shall be rotated through 360° about the original axis of the bent terminal in alternating direction for a total of 3 rotations.															
Solderability	95% coverage Min.		4.17 The area covered with a new, smooth, clean, shiny and continuous surface free from concentrated pinholes. Test temp. Of solder:245°C±3°C Dwell time in solder: 2~3seconds.															
Temperature cycling	Resistance change rate is: ±(1%+0.05Ω) Max.. With no evidence of mechanical damage.		4.19 Resistance change after continuous five cycles for duty cycle specified: <table border="1" style="margin-left: 20px;"> <thead> <tr> <th>Step</th> <th>Temperature</th> <th>Time</th> </tr> </thead> <tbody> <tr> <td>1</td> <td>-55°C ± 3°C</td> <td>30min</td> </tr> <tr> <td>2</td> <td>Room temp.</td> <td>10 - 15min</td> </tr> <tr> <td>3</td> <td>+155°C ± 2°C</td> <td>30min</td> </tr> <tr> <td>4</td> <td>Room temp.</td> <td>10 - 15min</td> </tr> </tbody> </table>	Step	Temperature	Time	1	-55°C ± 3°C	30min	2	Room temp.	10 - 15min	3	+155°C ± 2°C	30min	4	Room temp.	10 - 15min
Step	Temperature	Time																
1	-55°C ± 3°C	30min																
2	Room temp.	10 - 15min																
3	+155°C ± 2°C	30min																
4	Room temp.	10 - 15min																
Load life in humidity	Normal type: ±1.5%; flame retardant type: ±5%		7.9 resistance change after 1,000 hours (1.5 hours "ON",0.5 hour "OFF") at RCWV in a humidity test chamber controlled at 40°C±2°C and 90 to 95% relative humidity.															
Load life	Normal type: ±1.5%; flame retardant type: ±5%		4.25.1 permanent resistance change after 1,000 hours operating at RCWV with duty cycle of 1.5 hours "ON", 0.5 hour "OFF" at 70°C±2°C ambient.															

Approved	Checked	Prepared	File NO.	Edition	Date	Page
William Zhao	Apple Liu	Wu Yiyun	JLC-01-008	1	2016/5/9	7/13



ISO14001



ISO/TS16949



244546



245468



REG.-Nr.A759



CQC04001010656

8.0 Explanation of Part No. System:

The standard Part No. includes 14 codes which explained as below:

8.1 1st ~ 4th codes: Item type

8.1.1 The 1st to 3rd codes: Product type;

8.1.2 The 4th code: Special feature.

Example: MFRF= Metal Film Fixed Resistors Non-flame type;

8.2 5th~6th codes: Power rating.

8.2.1 W=Normal Size; S=Small Size; U=Ultra Small Size;

1/16W~1/2W (<1W)

Wattage	1/2	1/3	1/4	1/5	1/6	1/8	0.6	0.4
Normal Size	W2	W3	W4	W5	W6	W8	/	/
Small Size	S2	S3	S4	S5	S6	S8	06	/
Ultra-Small Size	U2	U3	U4	U5	U6	U8	/	04

1W~16W (≥1W)

Wattage	1	2	3	5	7	8	9	10	15
Normal Size	1W	2W	3W	5W	7W	8W	9W	AW	FW
Small Size	1S	2S	3S	5S	7S	8S	9S	AS	FS
Ultra-Small Size	1U	2U	3U	5U	7U	8U	9U	AU	FU

8.2.2 If power rating is less than 1 watt, 5th code would be the letters W, S or U and 6th code would be a number or a letter code.

Example: WA=1/10W; U2=1/2W-SS.

8.2.3 If power rating is between 1~16 watt, 5th code would be a number or a letter code and 6th code will be the letters of W, S or U.

Example: AW=10W; 3S=3W-S

8.3 7th code: Resistance Tolerance.

B=±0.1% C=±0.25% D=±0.5% F=±1% G=±2% J=±5%

8.4 8th ~ 11th codes: Resistance Value

8.4.1 If resistance value belongs to E-24 series:

8.4.1.1 8th code must be "0"

8.4.1.2 9th & 10th codes: Significant figures of the resistance;

8.4.1.3 11th code: Power of ten.

8.4.2 If resistance value belongs to E-96 series:

8.4.2.1 8th ~10th codes: Significant figures of the resistance

8.4.2.2 11th code: Power of ten.

Approved	Checked	Prepared	File NO.	Edition	Date	Page
William Zhao	Apple Liu	Wu Yiyun	JLC-01-008	1	2016/5/9	8/13



8.4.2.3 We use this code in 11th code:

0=10⁰ 1=10¹ 2=10² 3=10³ 4=10⁴ 5=10⁵
 J=10⁻¹ K=10⁻² L=10⁻³ M=10⁻⁴

8.5 12th~14th codes.

8.5.1 12th code: Packaging Type

A=Tape/Box (Ammo pack) B=Bulk/Box T=Tape/Reel P=Tape/Box of PT-26

8.5.2 13th code: Packing Quantity of Tape/Box & Tape/Reel packaging types.

A=500pcs B=2500pcs 1=1000pcs 2=2000pcs

8.5.3 If product is FORMED, 13th~14th codes are forming types

MF=M-type with flattened lead wire F0= F-type
 MK= M-type with kinked lead wire F1= F1-type
 ML= M-type with normal lead wire F2= F2-type
 MC= M type with kinked lead and narrow pitch wire F3= F3-type

8.5.4 14th code: Special features of additional information

P=Panasert type 1=Avisert type 1 2=Avisert type 2
 3=Avisert type 3 A=Cutting type CO 1/4W-A type B= Cutting type CO 1/4W-B typ

9.0 Order procedure (Example: MFR 2W ±1% 200KΩ T/B-1000)



Approved	Checked	Prepared	File NO.	Edition	Date	Page
William Zhao	Apple Liu	Wu Yiyun	JLC-01-008	1	2016/5/9	9/13



ISO14001



ISO/TS16949



244546



245468



REG.-Nr.A759



CQC04001010656

10.0 Standard Packing:

10.1 Tapes in Box Packing

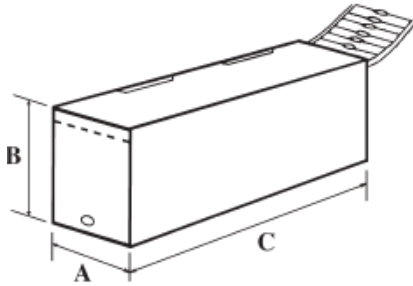

*L1-L2=1.0 Max.
 ZW: 0
 **S=0.5 Max.
 PT-26: 0.8 Max.

Dimension of T/B (mm)

Part No.	O	P	A±5	B±5	C±5	Qty/Box
MF 1/8W	52±1	5±0.3	75	70	255	5,000pcs
MF 1/4WS	52±1	5±0.3	75	70	255	5,000pcs
MF 1/4W	52±1	5±0.3	75	98	255	5,000pcs
MF 0.4WSS	52±1	5±0.3	75	70	255	5,000pcs
MF 1/2WSS	52±1	5±0.3	75	116	255	5,000pcs
MF 1/2WS	52±1	5±0.3	75	70	255	2,000pcs
MF 1/2W	52±1	5±0.3	75	45	255	1,000pcs
MF 0.6WS	52±1	5±0.3	75	116	255	5,000pcs
MF 1WS	58±1	5±0.3	80	70	255	1,000pcs
MF 1W	58±1	5±0.3	80	82	255	1,000pcs
MF 2WS	58±1	5±0.3	80	82	255	1,000pcs
MF 2W	65±5	10±0.5	90	88	255	1000pcs
MF 3WS	65±5	10±0.5	90	119	255	1000pcs
MF 3W	65±5	10±0.5	90	88	255	500pcs

Approved	Checked	Prepared	File NO.	Edition	Date	Page
William Zhao	Apple Liu	Wu Yiyun	JLC-01-008	1	2016/5/9	10/13



ISO14001

ISO/TS16949

244546

245468

REG.-Nr.A759

CQC04001610666

10.2 Tapes in Reel Packing

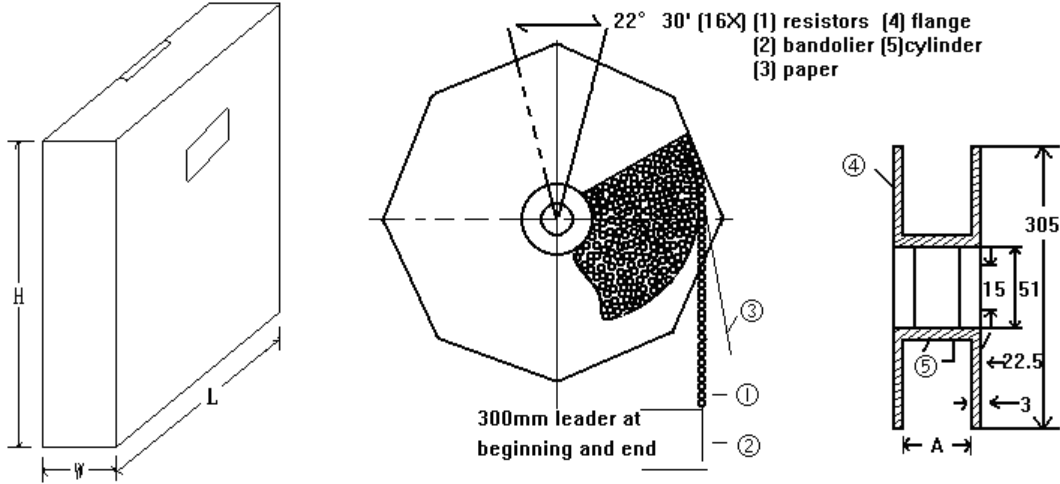

Dimension of Reel (mm)

Part No.	A	W±5	H±5	L±5	Qty/Box
MF 1/8W	73±2	85	295	293	5,000pcs
MF 1/4WS	73±2	85	295	293	5,000pcs
MF 1/4W	73±2	85	295	293	5,000pcs
MF 0.4WSS	73±2	85	295	293	5,000pcs
MF 1/2WSS	73±2	85	295	293	5,000pcs
MF 1/2WS	73±2	85	295	293	4,000pcs
MF 1/2W	73±2	85	295	293	4,000pcs
MF 0.6WS	73±2	85	295	293	5,000pcs
MF 1WS	73±2	85	295	293	2,500pcs
MF 1W	73±2	85	295	293	2,500pcs
MF 2WS	73±2	85	295	293	2,500pcs
MF 2W	80±5	95	295	293	1,000pcs
MF 3WS	80±5	95	295	293	1,000pcs
MF 3W	80±5	95	295	293	1,000pcs

Approved	Checked	Prepared	File NO.	Edition	Date	Page
William Zhao	Apple Liu	Wu Yiyun	JLC-01-008	1	2016/5/9	11/13



ISO14001



ISO/TS16949



244546



245468



REG.-Nr.A759



CQC04001610656

10.3 Bulk in Box Packing



Dimension of Box (mm)

Part No.	A±5	B±5	C±5	Qty/Box
MF 1/8W	140	80	240	1,000/20,000pcs
MF 1/4WS	140	80	240	1,000/20,000pcs
MF 1/4W	140	80	240	500/20,000pcs
MF 0.4WSS	140	80	240	1,000/20,000pcs
MF 1/2WSS	140	80	240	500/10,000pcs
MF 1/2WS	140	80	240	500/8,000pcs
MF 1/2W	140	80	240	250/2,000pcs
MF 0.6WS	140	80	240	500/10,000pcs
MF 1WS	140	80	240	200/4,000pcs
MF 1W	140	80	240	100/2,500pcs
MF 2WS	140	80	240	100/2,500pcs
MF 2W	140	80	240	100/1,500pcs
MF 3WS	140	80	240	100/1,500pcs
MF 3W	140	80	240	100/1,500pcs

Approved	Checked	Prepared	File NO.	Edition	Date	Page
William Zhao	Apple Liu	Wu Yiyun	JLC-01-008	1	2016/5/9	12/13



ISO14001



ISO/TS16949



244546



245468



REG.-Nr.A759



CQC04001010656

11.0 Note

11.1 UNIOHM strongly recommend the storage condition:

Temperature: 15°C~35°C; Humidity :25%~75%.

Even under storage condition UNIOHM recommended, solderability of products over 1 year would be still degraded.

11.2 Store / transport cartons in the correct direction, otherwise bent leads would be occurred due to excessive stress applied when dropping of a carton.

11.3 Product performance and soldered connections may deteriorate if the products are stored in the following places.

11.3.1 In high electrostatic;

11.3.2 In direct sunshine, rain, snow or condensation;

11.3.3 Exposed to sea winds or corrosive gases which contains Cl₂, H₂S, NH₃, SO₂, and NO₂

Approved	Checked	Prepared	File NO.	Edition	Date	Page
William Zhao	Apple Liu	Wu Yiyun	JLC-01-008	1	2016/5/9	13/13

X-ON Electronics

Largest Supplier of Electrical and Electronic Components

Click to view similar products for [Metal Film Resistors - Through Hole](#) category:

Click to view products by [Uniroyal](#) manufacturer:

Other Similar products are found below :

[MF2S-6K8JI](#) [MFP2-20KJI](#) [GP55S-1002-FTW](#) [GP55S-1004-FTW](#) [GP55S-4753-FTW](#) [QW210](#) [RCFH-0.5-5TA](#) [RCFH-100-5TA](#) [RCFH-10-5TA](#) [RCFH-110-5TA](#) [RCFH-11K-5TA](#) [RCFH-11M-5TA](#) [RCFH-12K-5TA](#) [RCFH-130K-5TA](#) [RCFH-13-5TA](#) [RCFH-13K-5TA](#) [RCFH-13M-5TA](#) [RCFH-150K-5TA](#) [RCFH-15-5TA](#) [RCFH-160-5TA](#) [RCFH-160K-5TA](#) [RCFH-16-5TA](#) [RCFH-180K-5TA](#) [RCFH-18K-5TA](#) [RCFH-1M-5TA](#) [RCFH-200-5TA](#) [RCFH-200K-5TA](#) [RCFH-20K-5TA](#) [RCFH-220-5TA](#) [RCFH-220K-5TA](#) [RCFH-22K-5TA](#) [RCFH-2.2M-5TA](#) [RCFH-240K-5TA](#) [RCFH-24K-5TA](#) [RCFH-2-5TA](#) [RCFH-27-5TA](#) [RCFH-27K-5TA](#) [RCFH-2M-5TA](#) [RCFH-330-5TA](#) [RCFH-33-5TA](#) [RCFH-3.3M-5TA](#) [RCFH-360-5TA](#) [RCFH-360K-5TA](#) [RCFH-3.6M-5TA](#) [RCFH-39-5TA](#) [RCFH-39K-5TA](#) [RCFH-3.9M-5TA](#) [RCFH-430-5TA](#) [RCFH-47K-5TA](#) [RCFH-510K-5TA](#)