

Specification for Approval

Customer : 深圳市立創電子商務有限公司

Product Name: Metal Strip Current Sensing Chip Resistors

Part Name : MS SERIES

Part No. : MS****J****T*E、MS****F****T*E

Building 8, Jiuwei Industrial Zone, Xixiang Town, Bao'An District ,Shenzhen, Guangdong, China

TEL: 0755-61861797

FAX: 0755-27484308

Approved	Checked	Prepared	File NO.	Edition	Date	Page
William Zhao	Ted Hsu	Chengxia Tang	JLC-01-016	1	2017/07/03	1 / 10

Content

Index

1.0	Scope	4
2.0	Ratings & dimension	4
3.0	Power Rating.....	5
4.0	Voltage rating.....	5
5.0	Structure	5
6.0	Marking	5
7.0	Performance specification	6
8.0	Part No. System.....	7
9.0	Ordering Procedure.....	7
10.0	Packaging	8
11.0	Note	10

Approved	Checked	Prepared	File NO.	Edition	Date	Page
William Zhao	Ted Hsu	Chengxia Tang	JLC-01-016	1	2017/07/03	2 / 10

厚聲國際貿易(昆山)有限公司深圳分公司
Uniroyal Electronics Global Co.,Ltd Shenzhen Branch



File Name: MS SERIES			Date	2017/07/03	Edition No.	1
Amendment Record				Signature		
Edition	Description	Page	Date	Amended by	Checked by	
Approved	Checked	Prepared	File NO.	Edition	Date	Page
William Zhao	Ted Hsu	Chengxia Tang	JLC-01-016	1	2017/07/03	3 / 10

厚聲國際貿易(昆山)有限公司深圳分公司

Uniroyal Electronics Global Co.,Ltd Shenzhen Branch



1.0 Scope:

This file is specification of **Metal Strip Current Sensing Chip Resistors** manufactured by UNIOHM.

2.0 Ratings & dimension:

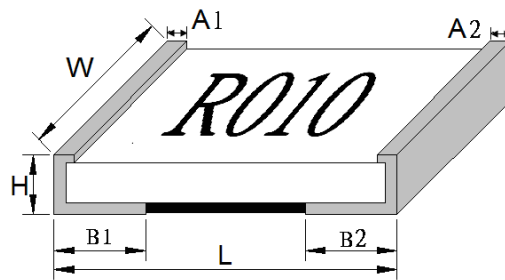

Dimension (mm)

Type	Power 70°C	Dimension(mm)					Resistance Range
		L	W	H	A1/A2	B1/B2	1.0%&5%
MS05	1/2W	2.00±0.30	1.20±0.30	0.60±0.20	≤1.0	0.50±0.25	5~30mΩ
MS06	1W	3.10±0.20	1.60±0.30	0.70±0.20	≤1.0	0.50~1.00±0.25	3~51mΩ
MS07	1.5W	3.10±0.20	2.50±0.25	0.70±0.20	≤1.0	0.65±0.25	3~150mΩ
MS11	2W	4.40±0.20	3.20±0.25	0.70±0.20	≤1.0	0.80~1.50±0.30	2~100mΩ
MS10	1.5W	5.00±0.20	2.50±0.25	0.70±0.20	≤1.0	0.70~1.40±0.30	2~150mΩ
MS12	3W	6.35±0.20	3.20±0.25	1.00±0.20	≤1.0	1.80~2.50±0.30	1~2mΩ
	3W	6.35±0.20	3.20±0.25	0.70±0.20	≤1.0	1.20~1.90±0.30	3~100mΩ
	2W	6.35±0.20	3.20±0.25	0.70±0.20	≤1.0	1.20~1.90±0.30	101~250mΩ
MS28	4W	6.70±0.20	7.20±0.25	0.70±0.20	≤1.0	0.80±0.30	5~100mΩ
MS17	3W	7.10±0.20	4.20±0.20	0.70±0.20	≤1.0	1.10~1.50±0.30	3~150mΩ
MS20	5W	11.00±0.30	5.00±0.25	0.65±0.20	≤1.0	2.50±0.30	10~20mΩ
	3W	11.00±0.30	5.00±0.25	0.65±0.20	≤1.0	2.50±0.30	2~9mΩ 21~50mΩ
MS27	5W	11.60±0.30	6.70±0.25	0.60±0.20	≤1.0	2.50±0.30	10~30mΩ
	3W	11.60±0.30	6.70±0.25	0.60±0.20	≤1.0	2.50±0.30	2~9mΩ 31~100mΩ

Approved	Checked	Prepared	File NO.	Edition	Date	Page
William Zhao	Ted Hsu	Chengxia Tang	JLC-01-016	1	2017/07/03	4 / 10



3.0 Power Rating:

Resistor shall have a power rating based on continuous load operation at ambient temperature from -55°C to 155°C.

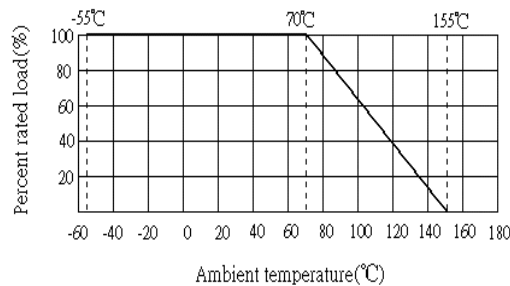

4.0 Voltage rating:

Resistor shall have one voltage specifications at direct-current (DC) continuous voltage or approximate single-wave root-mean-square (RMS) alternating-current (AC) continuous working voltage. We can calculate the Voltage from the following formula:

$$RCWV = \sqrt{P \times R}$$

Remark:

RCWV: Rate Continuous Working Voltage. (Volt)

P: Power Rating (Watt.)

R: Nominal Resistance (Ohm)

5.0 Structure:

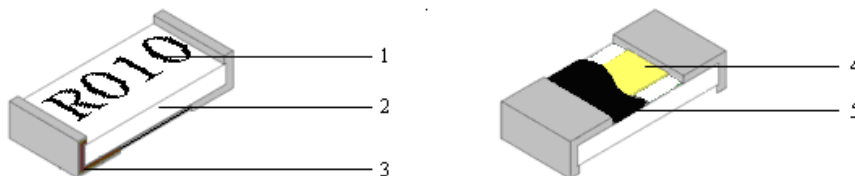

1	Marking	4	Resistance layer
2	Alumina Substrate	5	Protective layer
3	Terminal (Cu/Ni/ Sn)		

6.0 Marking:

First code should be "R" which meaning as decimal point.

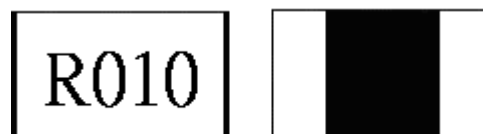

R010 → 10mΩ

Approved	Checked	Prepared	File NO.	Edition	Date	Page
William Zhao	Ted Hsu	Chengxia Tang	JLC-01-016	1	2017/07/03	5 / 10

厚聲國際貿易(昆山)有限公司深圳分公司

Uniroyal Electronics Global Co.,Ltd Shenzhen Branch



7.0 Performance specification:

Item	Limits	Test Method (JIS-C-5201&5202)
Temperature Coefficient	MS05	5~30mΩ : ±150ppm/°C
	MS06	3~25mΩ : ±100ppm/°C 26~51 mΩ : ±50ppm/°C
	MS07	±30ppm/°C
	MS11	±30ppm/°C
	MS10	2~10mΩ : ±50ppm/°C 11~150mΩ : ±30ppm/°C
	MS12	2W 101-250mΩ: ±30ppm/°C 3W 3-100mΩ: ±30ppm/°C 3W 1~2 mΩ: ±50ppm/°C
	MS28	±50ppm/°C
	MS17	±30ppm/°C
	MS20	±30ppm/°C
	MS27	±30ppm/°C
		Resistance value will change when temperature changes per centigrade. $\frac{R_2 - R_1}{R_1 (T_1 - T_2)} \times 10^6 (PPM/°C)$ R ₁ : Resistance value at room temp. (t ₁) R ₂ : Resistance value at room temp.+100°C (t ₂) Test condition: 1 st condition: room temp. (t ₁), 2 nd condition: room temp. +100°C(t ₂)
Item	Limits	Test Method (JIS-C-5201&5202)
Short-time overload	Resistance change rate must be in 1%: ±(1%+0.001Ω) 5%:±(2%+0.001Ω) and no mechanical damage.	Permanent resistance change after the application of a potential of 5 times rated power for 5 seconds.
Low Temperature Storage	±(1.0%+0.001Ω)ΔR	- 55 °C for 1000hrs
High Temperature Exposure	±(1.0%+0.001Ω)ΔR	155°C for 1000hrs
Solderability	More than 95% coverage rate	The surface of solder must be new, smooth, clean, shiny and continuous, and without concentrated pinholes. The solder's temperature must be within 245±3°C.Hold in hot solder 2~3seconds.
Resistance rate of change after soldering heat	±(0.5%+0.005Ω)ΔR	Dipped into solder at 260°Cfor 10 seconds.
Load life	1%:± (1%+0.001Ω)ΔR 5%:± (3%+0.001Ω)ΔR Without mechanical damage	Permanent resistance change after 1,000 hours operating at rated power at 70±2°C, 1.5hrs ON ,0.5hrs OFF.
Temperature cycling	± (0.5%+0.005Ω)ΔR	-55°Cto+155°C, 5cycles,30min at each extreme test cycle
Load life in humidity	1%:± (1.0%+0.001Ω)ΔR 5%:± (3.0%+0.001Ω)ΔR	40±2°C,1000hrs at rated power,90~95%RH , 1.5hrs ON,0.5hrs OFF.

Approved	Checked	Prepared	File NO.	Edition	Date	Page
William Zhao	Ted Hsu	Chengxia Tang	JLC-01-016	1	2017/07/03	6 / 10



8.0 Part No. System:

Part No. System has 14 codes.

8.1 1st ~4th codes: Product name. E.g.:MS05, MS06, MS07,MS10, MS11,MS12, MS17, MS20, MS27

8.2 5th ~6th codes: Power rating.

E.g.: W=Normal Size; "1"~"G"to denotes"1"~"16"as Hexadecimal:1W~16W ($\geq 1W$)

Wattage	1	2	3	5	7	8	9	10	15
code	1W	2W	3W	5W	7W	8W	9W	AW	FW
Wattage	1/2	1/3	1/4	1/5	1/7	1/8	1/9	1/10	1/15
code	W2	W3	W4	W5	W7	W8	W9	WA	WF

8.3 7th code: Resistors' tolerance. E.g.: F= $\pm 1\%$ J= $\pm 5\%$

8.4 8th ~ 11th codes: Resistance value.

8.4.1 If the value belongs to E-96 series, 8th~10th digits means the significant figures of the resistance and the 11th digit are the power of ten.

8.4.2 We use the power of ten in 11th digit.

0= 10^0 1= 10^1 2= 10^2 3= 10^3 4= 10^4 5= 10^5 6= 10^6 J= 10^{-1} K= 10^{-2} L= 10^{-3} M= 10^{-4}

8.5 12th code: Packaging Type. E.g.: T: Tape/Reel

13th code: Standard Packing Quantity.

E.g.: 1=1,000PCS 2=2,000PCS 3=3,000PCS 4=4,000 PCS 5=5,000PCS

8.6 14th code: Special features information. E.g.: E=For "Environmental Protection, Lead Free type"

9.0 Ordering Procedure:(Example: MS12 2W $\pm 1\%$ 0.15 Ω T/R-4000)

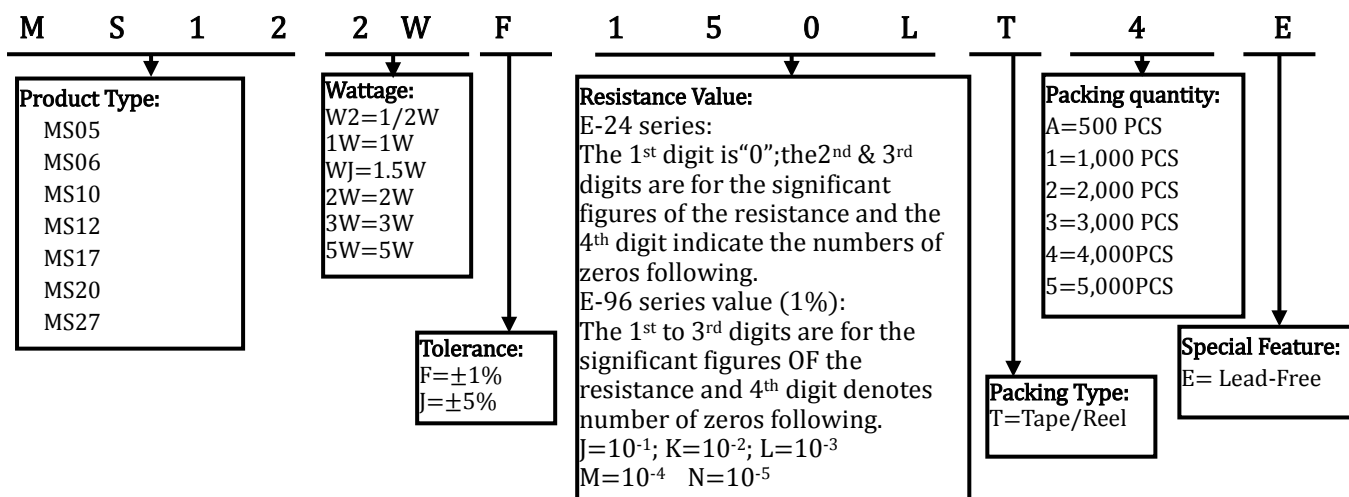

Approved	Checked	Prepared	File NO.	Edition	Date	Page
William Zhao	Ted Hsu	Chengxia Tang	JLC-01-016	1	2017/07/03	7 / 10

10.0 Packaging:

10.1 Tapping dimension:

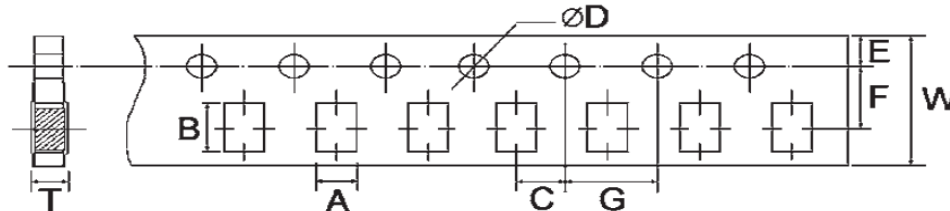

Unit: mm

TYPE	A ± 0.2	B ± 0.2	C ± 0.05	φD+0.1	E ± 0.1	F ± 0.05	W ± 0.2	T ± 0.10	G ± 0.1
MS05	2.00	3.6	2.00	1.50	1.75	3.50	8.00	0.81	4.00
MS06	2.00	3.60	2.00	1.50	1.75	3.50	8.00	0.81	4.00
MS07	2.80	3.50	2.00	1.50	1.75	3.50	8.00	0.75	4.00

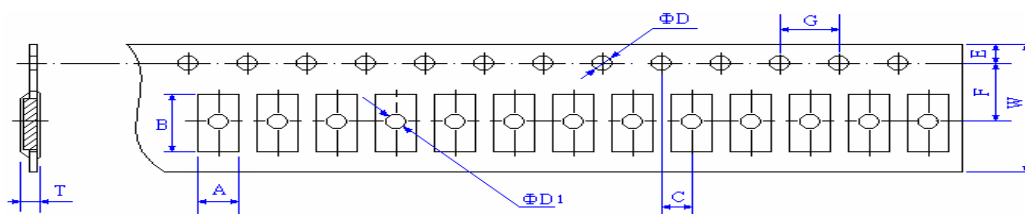

Unit: mm

TYPE	A ± 0.2	B ± 0.2	C ± 0.05	φD+0.1	φD1+0.25	E ± 0.1	F ± 0.05	W ± 0.2	T ± 0.10	G ± 0.1
MS10	2.80	5.40	2.00	1.50	1.50	1.75	5.50	12.00	0.75	4.00
MS11	3.50	4.80	2.00	1.50	1.50	1.75	5.50	12.00	1.00	4.00
MS12	3.50	6.70	2.00	1.50	1.50	1.75	5.50	12.00	1.00	4.00

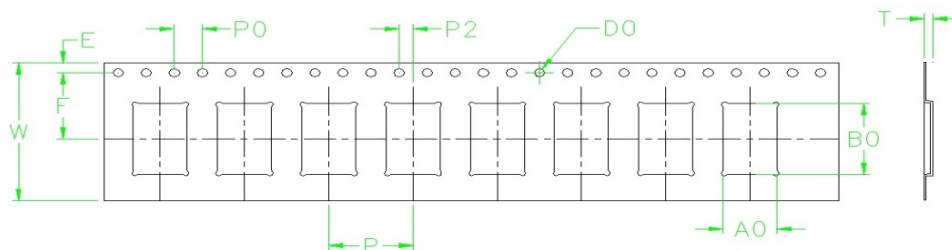

Unit: mm

TYPE	W ± 0.3	A0 ± 0.1	B0 ± 0.1	P ± 0.1	F ± 0.1	E ± 0.1	D0 + 0.1	P0 ± 0.1	P2 ± 0.1	T ± 0.05
MS17	16.0	4.50	7.40	8.00	7.50	1.75	1.5	4.0	2.0	0.30

Approved	Checked	Prepared	File NO.	Edition	Date	Page
William Zhao	Ted Hsu	Chengxia Tang	JLC-01-016	1	2017/07/03	8 / 10

厚聲國際貿易(昆山)有限公司深圳分公司

Uniroyal Electronics Global Co.,Ltd Shenzhen Branch



TYPE	W±0.3	A0±0.1	B0±0.1	P±0.1	F±0.1	E±0.1	D0±0.1	P0±0.1	P2±0.1	T±0.05
MS20	24.0	5.40	11.5	8.0	11.5	1.75	1.5	4.0	2.0	0.3

TYPE	W±0.5	A0±0.2	B0±0.2	P±0.2	F±0.3	E±0.2	D0±0.2	P0±0.2	P2±0.3	T±0.2
MS27	24.0	7.2	11.9	12.0	11.5	1.75	1.5	4.0	2.0	1.3

10.2 Reel dimension:

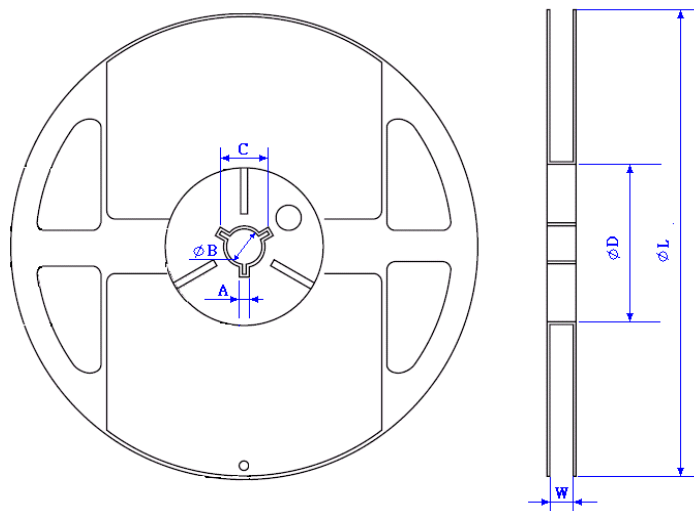

UNIT: mm

TYPE	TAPING	Qty/Reel	A±0.5	B±0.5	C±0.5	ΦD±1	ΦL±2	W±1
MS05	Emboss Plastic Tape	5,000pcs	2.0	13.0	21.0	60.0	178.0	10.0
MS06	Emboss Plastic Tape	5,000pcs	2.0	13.0	21.0	60.0	178.0	10.0
MS07	Emboss Plastic Tape	5,000pcs	2.0	13.0	21.0	60.0	178.0	10.0
MS10	Emboss Plastic Tape	4,000pcs	2.0	13.0	21.0	60.0	178.0	13.8
MS11	Emboss Plastic Tape	4,000pcs	2.0	13.0	21.0	60.0	178.0	13.8
MS12	Emboss Plastic Tape	4,000pcs	2.0	13.0	21.0	60.0	178.0	13.8

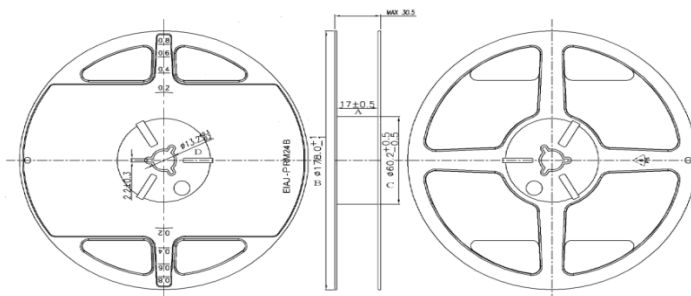

Approved	Checked	Prepared	File NO.	Edition	Date	Page
William Zhao	Ted Hsu	Chengxia Tang	JLC-01-016	1	2017/07/03	9 / 10

厚聲國際貿易(昆山)有限公司深圳分公司

Uniroyal Electronics Global Co.,Ltd Shenzhen Branch



UNIT: mm

TYPE	TAPING	Qty/Reel	A±0.5	B±1.0	C±0.5	D ^{+0.3} _{-0.2}
MS17	Embossed	1,000pcs	17.0	178.0	60.2	13.2

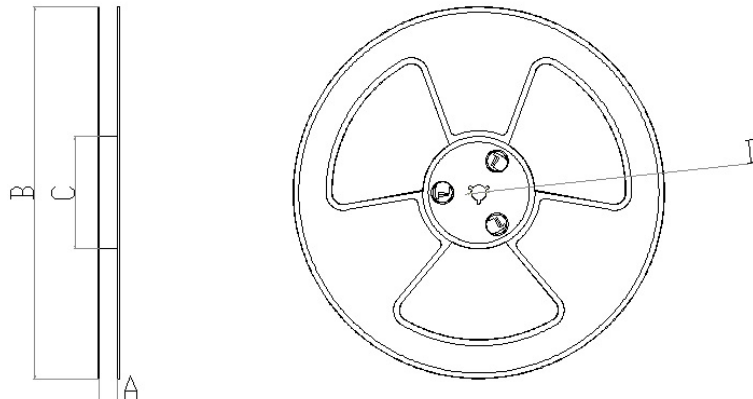

UNIT: mm

TYPE	TAPING	Qty/Reel	A±1.0	B±2.0	C±1.0	D±0.2
MS20	Embossed	1,000pcs	25.4	330.0	100.0	13.0

TYPE	TAPING	Qty/Reel	A±0.5	B±1.5	C±1.5	D±0.5
MS27	Embossed	1,000pcs	24.5	330.0	100.0	13.0

11.0 Note:

11.1 UNIOHM recommends the storage condition as below:

11.1.1 Temperature: 15°C~35°C.

11.1.2 Humidity: 25%~75%.

Even under recommended condition, products' solderability will degrade day by day.

11.2 Please hold the cartons in correct direction signed on cartons' side during storage and delivery.

11.3 Resistor performance and solderability will fail if stored in the following condition:

11.3.1 High electrostatic environment.

11.3.2 Direct sunlight, rain, snow and so on.

11.3.3 In sea wind or corrosive gases long time, including Cl₂, H₂S, NH₃, SO₂, and NO₂.

Approved	Checked	Prepared	File NO.	Edition	Date	Page
William Zhao	Ted Hsu	Chengxia Tang	JLC-01-016	1	2017/07/03	10 / 10

X-ON Electronics

Largest Supplier of Electrical and Electronic Components

Click to view similar products for [Current Sense Resistors - SMD category](#):

Click to view products by [Uniroyal manufacturer](#):

Other Similar products are found below :

[CRL0603-FW-R700ELF](#) [PFS35-200RF1](#) [NPS 2-T126 5.000 OHM 1%](#) [PFS35-0R01J1](#) [PFS35-0R05J1](#) [PFS35-5RF1](#) [CD2015FC-0.10-1%](#)
[PR2512FKF7W0R004L](#) [RC1005F124CS](#) [RL73K3AR56JTDF](#) [RL7520WT-R001-F](#) [RL7520WT-R009-G](#) [RL7520WT-R020-F](#)
[RLP73N1ER43JTD](#) [LRC-LR2512LF-01-R820J](#) [WR06X104JGLJ](#) [TL2BR01F](#) [65709-330](#) [SP1R12J](#) [RL7520WT-R039-G](#) [RL7520WT-R002-F](#)
[LRF2010-R003JW](#) [KRL1632E-C-R200-F-T5](#) [KRL1632E-C-R200-F-T1](#) [Y14880R02000B9R](#) [RLP73M1ER051FTDF](#) [RLP73M2AR051FTDF](#)
[RLP73M2AR075FTDF](#) [RLP73M1JR051FTDF](#) [RLP73N1JR47FTDF](#) [SR731ERTTP5R10F](#) [SR731ERTTP100J](#) [SR731ERTTP6R80F](#)
[SR731ERTTP4R70F](#) [SR731ERTTP2R20F](#) [SR731ERTTP3R90F](#) [SR731ERTTP1R00F](#) [SR731ERTTP10R0F](#) [SR731ERTTP2R00F](#)
[SR731ERTTP8R20F](#) [SR731ERTTP3R9J](#) [SR731ERTTP8R2J](#) [SR731ERTTP2R0J](#) [SR731ERTTP4R7J](#) [SR731ERTTP9R1J](#) [SR731ERTTP1R0J](#)
[SR731ERTTP2R2J](#) [SR731ERTTP5R1J](#) [SR731ERTTP6R8J](#) [SR731ERTTP9R10F](#)