



UNI·ROYAL
厚聲集團

2019~2020

厚聲電阻



Our Mission:

Create value for customers, business associates and partners by providing reliable products and quality services.

我们的使命：

通过提供可信赖的产品和服务，为顾客、企业成员和合作伙伴创造价值。

Our Vision:

Become an excellent global supplier of passive components.

Be a respectable corporation to customers, business associates and partners.

我们的愿景：

以产品和服务成为电子制造业卓越的全球供货商。
做客户、企业成员、合作伙伴尊敬的企业。



厚声集团·昆山总部 (Kunshan HQ)

UNI-ROYAL Group, founded in Hsinchu, Taiwan in 1978, has become a global leader in CHIP and DIP resistors industry. With more than 40 years of manufacturing experience, UNI-ROYAL has a profound industry insight and innovation leadership for the global electronics industry. UNI-ROYAL has a complete R&D team, manufacturing plants, global sales team and marketing service network located in Taiwan, Kunshan, Shenzhen, Xiamen, and Southeast Asia (Thailand). The group's four well-known brands: **ROYALOHM**, **UNIOHM**, **FOSS**, **AEON**, has become the world's favorite passive components suppliers and preferred partners.

UNI-ROYAL has successively been awarded many international standard system certifications such as QS9000, ISO14001, TL9000 and IATF16949. Products are widely used in microelectronics, mobile terminals, industrial equipment, automotive electronics, the Internet and other emerging civil and military high-tech industries. With the continuous development of the global economy, the iterative update of modern technology, especially the ever-changing application and innovation in the field of electronics, UNI-ROYAL has always provided cutting-edge technology, excellent products and leading solutions to supply a full range of products and services to well-known companies in the global industry.

厚声集团，始创于1978年台湾新竹，迄今已经成为全球晶片电阻和插件电阻的行业领导者。凭借逾四十年的制造经验，厚声对全球电子行业拥有深刻的行业洞察与创新领导能力。集团在台湾、昆山、深圳、厦门与东南亚（泰国）拥有完善的电阻研发团队、制造工厂及遍布全球的销售团队和营销服务网络。集团旗下四大著名品牌：**ROYALOHM**、**UNIOHM**、**FOSS**、**AEON**，已成为全球各行业备受青睐的被动元器件重要供货商和首选合作伙伴。

厚声先后获得 QS9000、ISO14001、TL9000、IATF16949 等多项国际标准体系认证。产品广泛应用于微电子、移动终端、工业设备、汽车电子、物联网等新兴民用与军工众多高科技领域。随着全球经济的不断发展、现代化技术的迭代更新，特别是电子领域日新月异的应用革新，厚声始终以前沿的技术、出色的产品和领先的解决方案，向全球行业知名企业提供全方位的产品和服务。



Milestone

- 1978 Hsinchu, Taiwan Uniroyal Taiwan
- 1988 Bangkok, Thailand Royal Electronic Factory (Thailand) Co., Ltd.
- 1992 Kunshan, China Uniroyal Electronics Industry Co., Ltd
- 2003 Kunshan, China FOSS Electronics Material
- 2009 Xiamen, China Aeon Technology (Xiamen) Corporation
- 2014 Kunshan, China Uniroyal Electronics Industry Co., Ltd - New Area
- 2016 Kunshan, China Uniroyal Electronics Global Co., Ltd.: KS HQ, Shenzhen Branch, Xiamen Branch

厚声集团沿革

- 1978 台湾新竹 台湾厚声
- 1988 泰国曼谷 泰国厚声
- 1992 中国昆山 昆山厚声
- 2003 中国昆山 昆山福仕电材
- 2009 中国厦门 厦门翔声科技
- 2014 中国昆山 昆山厚声 - 新厂区
- 2016 中国昆山 厚声国际贸易：昆山总公司、深圳分公司、厦门分公司

泰国一厂 (Thailand 1988)

厦门翔声厂 (Xiamen 2009)



昆山福仕厂 (Kunshan 2003)

泰国二厂 (Thailand 2015)



Resistor

Resistor is a basic component in electronic circuits to control current flow and voltage. They are widely used in electronic circuits and electronic products. Uniroyal Group's products include thin film, thick film chip resistors, DIP type resistors such as DIP array resistors, carbon film, metal film, metal oxide film, metal glaze, wire-wound resistors, cement type resistors, power-type resistors and customized products of various special requirements..

电阻器

电阻器是电子线路中控制电流及电压的最基本元件，被广泛应用于电子电路及电子产品中，厚声集团的产品包括薄膜、厚膜晶片电阻，插件电阻如 DIP 排列电阻、碳膜、金属膜、金属氧化膜、玻璃釉、绕线电阻、水泥电阻、功率型电阻以及各种特殊要求的客制化产品。

Electronics Material

Foss Electronics Material Industry Co., Ltd. is one of the world's leading supplier of high quality electronic materials. Its products include all kinds of raw materials, including ceramic rods, capped white ceramic rods, capped sorted filmed-rods, filmed ceramic rods, etc, and various types of ceramic cases and different sizes of iron caps, tin-plated iron caps, etc.

电子材料

福仕电子材料工业有限公司是全球主要的优质电子材料供货商之一。其产品包括各种原材料棒体，包括瓷棒、压帽白棒、组分棒、电阻着膜棒等；各类陶瓷外壳及不同尺寸铁帽、镀锡铁帽等。



Ceramic Substrate

Aeon Technology (Xiamen) provides high-quality precision ceramic substrates that can meet high-end industry applications. Its products are widely used in commercial lighting, indoor lighting, outdoor lighting and decorative lighting applications.

散热基板

翔声科技提供的优质高精度陶瓷散热基板，能满足高端应用，可广泛应用于商业照明、室内照明、户外照明和装饰照明等。



High-Precision Thin Film Chip Resistors-TC

Precision thin film sputtering technology is used in this product. The resistance layer is made of high purity alloy target material. The film structure is compact and rules applied in the inter-ion alignment. It has good temperature stability, low noise coefficient and high reliability. The product can be widely used in medical equipments, precision measuring instruments, communication and precision industrial control equipments.

高精度薄膜晶片电阻器

产品采用精密薄膜溅射技术，电阻层采用高纯度合金靶材溅射而成，膜层结构致密，离子间排列有规则，具有良好的温度稳定性及噪音系数、可靠性高，产品可广泛应用于医疗器材、精密测量仪器、通讯及精密工业控制设备中。

Anti-Sulfurized Thick Film Chip Resistors – NS

NS series resistor is produced by high precision thick film printing technology, use special materials and production processes. The product has excellent corrosion resistance and anti-sulfur performance capability. It is widely used in automotive electronics, instruments and meters, mining machinery, farm equipment and instruments or equipment exposed to sulfur atmosphere.

抗硫化厚膜晶片电阻器

电阻采用高精厚膜印刷技术制造，特殊的材料和生产工艺生产而成。产品具有优异的耐腐蚀性能和抗硫化能力。广泛应用于汽车电子、仪表、矿山机械、农场设备及含硫环境的仪器中。



Uni-Royal can produce multiple resistors and packaged wafer resistors and lead-type single-row in-line resistors. They can also be designed to meet the customer's requirements for RC or RL network Resistors. They can also be designed with customer-made temperature detection. Functional overcurrent soft protection component.

厚声电阻可生产多颗电阻封装于一体的晶片排阻和引线型单列直插式排阻，也可配合客户需求设计制做 RC 或 RL 网络排阻，还可以配合客户设计制做带温度检测功能的过流软保护元件。

High-Voltage Thick Film Chip Resistors-HV

HV series resistor uses precision thick film printing technology, with unique product design and manufacturing process, so that the product has excellent resistance to high voltage performance, high-voltage resistance is more than twice that of conventional thick film products. It saves cost and help reduce space on the circuit boards; thus effectively reducing the final size of the equipment.

高压厚膜晶片电阻器

电阻采用精密厚膜印刷技术，通过特有的产品设计及制做工艺，使产品具有极好的耐高电压性能，耐高电压特性是常规厚膜产品的 2 倍多，可减小电路板的安装空间及节约产品成本，同时可有效降低设备的最终尺寸。



Metal Foil Current Sensing Chip Resistors - MS

MS series resistor uses photolithography technology allowing circuit patterns to be transferred on to the ceramic substrate. It has excellent temperature stability. The temperature coefficient is 30 PPM/°C or even lower. The product is widely used in current detection circuits and power management applications.

金属带电流检测片式电阻器

产品采用黄光影像转移技术，在陶瓷基板上形成电路，具有极好的温度稳定性，温度系数 30PPM/°C，甚至更低，产品广泛应用于电流检测电路及电源管理电路中。

Series 产品系列	Item or Type 规格	Page
Thick Film Surface Mount Chip Resistors 厚膜表面贴装晶片电阻		
Thick Film Chip Resistors 厚膜晶片电阻器	01005, 0201, 0402, 0603, 0805, 1206, 1210, 1812, 2010, 2512	10
High Value Thick Film Resistors 高阻厚膜晶片电阻器	0603, 0805, 1206, 1210	13
High-Power Thick Film Chip Resistors-HP 高功率厚膜晶片电阻器	HP02, HP03, HP05, HP06, HP07, HP10, HP11, HP12	14
Ultra High Power Thick Film Chip Resistors - SP 超高功率厚膜晶片电阻器	SP10, SP12, SP17, SP020, SP027	16
High-Voltage Thick Film Chip Resistors - HV 高压厚膜晶片电阻器	HV03, HV05, HV06, HV07, HV10, HV12	18
Anti-Surge Thick Film Chip Resistors - AS 抗浪涌厚膜晶片电阻器	AS02, AS03, AS05, AS06, AS07, AS10, AS12	20
High-Precision Anti-Surge Thick Film Chip Resistors - PS 高精度抗浪涌厚膜晶片电阻器	PS02, PS03, PS05, PS06, PS07, PS10, PS12	22
Low T.C.R Thick Film Chip Resistors - LT 低温度系数厚膜晶片电阻器	LT02, LT03, LT05, LT06	24
Flex LED Strip use Thick Film Chip Resistor - LE 软灯条专用芯片电阻器	LE05, LE06	26
Wide Terminal Thick Film Chip Resistor - WR 宽电极厚膜晶片电阻器	WR08, WR12, WR18, WR20, WR25	28
Trimable Thick Film Chip Resistors - TR 可调厚膜晶片电阻器	TR03, TR05, TR06	30
Anti-Electro Static Discharge Thick Film Chip Resistors - ES 抗静电厚膜晶片电阻器	ES01, ES02, ES03, ES05, ES06, ES07	32
Non-magnetic Thick Film Chip Resistors - NM 无磁厚膜晶片电阻器	NM02, NM03, NM05, NM06, NM12	34
Thick Film Surface Mount Lead Free Chip Resistors 厚膜表面贴装无铅晶片电阻		
Complete Pb-Free Thick Film Chip Resistor - PF 完全无铅厚膜晶片电阻器	PF0A, PF01, PF02, PF03, PF05, PF06, PF07, PF11, PF10, PF12	36
Thin Film Type Surface Mount Chip Resistors 薄膜类表面贴装晶片电阻		
High-Precision Thin Film Chip Resistors - TC 高精度薄膜晶片电阻器	TC02, TC03, TC05, TC06, TC07, TC10, TC12	38
Current Sensing Chip Resistors 电流检测晶片电阻器		
Metal foil Chip resistor - MS 合金箔式电阻器	MS05, MS06, MS07, MS10, MS12	40
Metal Strip Chip Resistors 合金体电阻	LR06, LR10, LR12	42
Chip Resistors Shunt - RS 贴片分流电阻器	RS12, RS21, RS31	44
AEC-Q200 Relevant Provision Resistor AEC-Q200 相关条款电阻器		
Automotive Thick Film Chip Resistors - CQ 汽车级晶片电阻器	CQ02, CQ03, CQ05, CQ06, CQ07, CQ10, CQ12	46
Automotive High Power Thick Film Chip Resistors-HQ 汽车级高功率晶片电阻器	HQ02, HQ03, HQ05, HQ06, HQ07, HQ10, HQ12	48
Automotive Low Resistance Thick Film Chip resistor-CS 汽车级低阻厚膜晶片电阻器	CS02, CS03, CS05, CS06, CS07, CS10, CS11, CS12	50
Anti-Sulfurized Automotive Thick Film Chip Resistors - NQ 抗硫化汽车级晶片电阻器	NQ01, NQ02, NQ03, NQ05, NQ06, NQ07, NQ10, NQ12	52
High Quality Anti-Sulfurized Automotive Thick Film Chip Resistors - NS 高品质抗硫化汽车级晶片电阻器	NS01, NS02, NS03, NS05, NS06, NS07, NS10, NS12	54
Anti-Sulfurized Thick Film Chip Resistor Array-Convex Terminal 抗硫化厚膜晶片排列电阻器	2S02, 4S02, 4S03	56
Array-Convex Terminal & Network Resistors 排列 & 网络电阻		
Chip Resistor Array 晶片排列电阻器	2F01, 4F01, 2C02, 4C02, 4C03, 2D02, 2D03, 4D02, 4D03, 4DP3, 16P8	58
Thick Film Chip Resistors Network 厚膜晶片网络电阻器	8R06, 8S06, 10P8, 10S8, 10T8, 10E9	60
Packing of Surface Mount Resistors 表面贴装式电阻器包装	Packing of Surface Mount Resistors	61
Through Hole Category-Film Resistors 插件类 - 膜层电阻		
Carbon Film Fixed Resistors 碳膜电阻器	CFR, CPR	63
Precision Metal Film Fixed Resistors 精密金属膜电阻器	MF	65
Power Metal Fixed Resistors 功率型金属膜固定电阻器	PMR	67
Metal Oxide Film Fixed Resistors 金属氧化膜固定电阻器	MOR	69
Terminal Type Metal Oxide Film Resistors 端片型金属氧化膜电阻器	TMOR, TMOV, TMOL	71
Metal Glaze Film Fixed Resistors 金属玻璃釉膜固定电阻器	MGR	72
Fusible Resistors 保险丝电阻器	FRN	74
Through Hole Category-Wire-wound Resistors 插件类 - 绕线电阻		
Wire-Wound Fixed Resistors 绕线型固定电阻器	KNP, KNH, KNS	75
Wire-Wound Non-Inductive Fixed Resistors 绕线型无感电阻器	KNPN	78
Wire-Wound Anti-Surge Fixed Resistors 绕线耐脉冲电阻器	KNPA	80
Wire-Wound Fusible Resistors 绕线保险丝型电阻器	KNPU	82
Wire-Wound Power Resistors 高功率绕线型电阻器	WPR	84
Thermal Fusing Wire-wound Fixed Resistors 绕线型温度保险丝电阻器	TFR	86
Through Hole Category-Special type & Forming process Resistors 插件类 - 特殊型别 & 成型加工电阻		
Jumper Wires & Zero-Ohm Resistors 跳线及零欧姆电阻器	ZW, ZOC, ZOT	87
Copper Plated Steel Lead Wire Type & Cutting Type 铜包钢导线型及切割半成品型	CP, CO	88
Vertical Taping 立式编带	Panasert, Avisert (AVI-1, AVI-2, AVI-3)	89
M & F Forming Type 加工型电阻器 M 型 & F 型	F, F1, F2, F3, M, MB, MC, MK, T	92
Heat-Shrinkable Tube Wrapped Forming Type 热缩套管式加工型	TZ1, TZ2, TZ3, TM, TF	93

Series 产品系列	Item or Type 规格	Page
Current Sense Resistors 电流检测电阻	CSRA, CSRB, CSRC, CSRD, CSRE, CSSA, CSSB, CSSC	94
Standard Packing of Coated Type Resistors 涂装型电阻器包装标准	Tape/Box, Tape/Reel, Bulk/Box	96
Thick Film Printing Through Hole Category-Network Resistors 厚膜印刷插件类 - 网络电阻		
Resistor Network - SIP Series 网络电阻器 - SIP 系列	RNL, RPL, RNM, RPH	105
Special Network -SIP Series 特殊网络电阻器 - SIP 系列	SN0001, SN0002, SN0003, SN0004, RCH, RCN, CNM, CNH	109
High Voltage Flat Resistors 高压扁平式电阻器	HFR	110
Metal Glazed Film Fixed Resistors - 玻璃釉膜固定电阻器	RC06, RC06 -1	111
Through Hole Category-Traditional Cement Resistors 插件类 - 水泥电阻		
Axial Leaded Type Cement Fixed Resistors-PRW Series 轴向导线型水泥固定电阻器 -PRW 系列	PRW, PRWC, PRWC-1, PRWA	112
Radial Type Cement Fixed Resistors-PRM&PRS Series 立式水泥固定电阻器 -PRM&PRS 系列	PRM, PRMA, PRMB, PRM, PRMT、	114
Power Flat Alloy Resistors-PFA Series 功率型合金箔扁平电阻器 -PFA 系列	PFAS, PFAP, PFAT	116
Radial Terminal Type Cement Fixed Resistors-PRT&PRU Series 立式端片型水泥固定电阻器 -PRT&PRU 系列	PRU0, PRUA, PRUB, PRT0, PRTA, PRTB	118
Cement Power Type Resistors 水泥功率型电阻		
Radial Terminal Type Cement Fixed Resistors 立式端片型水泥固定电阻器	PRVA, PRVB, PRZA, PRZA-1, PRZA-2, PRZC, PRZC-1, PRZD	120
Terminal Type-With metal mounting bracket 立式端片型带金属安装支架	PRS, PRTC, PRTD, PRTM	121
Lead Type Cement Fixed Resistors 导线型水泥固定电阻器	PHF-1, PHF-2, PHF-3, PRWI	122
Power Dissipation Mount Fixed Resistors 铝外壳电阻器	PDM, PDM-1, PDMS	123
High Power Wire-wound Aluminum Case Resistors 高功率绕线铝壳电阻器	HBWR, HEWR	124
Power Alloy Wire-wound Resistors 功率合金绕线电阻器	QH, QL, QR, QRZG	126
Custom Resistors-Automotive 定制型电阻 - 汽车类		
Custom Resistors-Automotive-1 定制型电阻器 - 汽车 -1	BCR, ASSY	128
Custom Resistors-Automotive-2 定制型电阻器 - 汽车 -2	HFWR	129
Custom Resistors-Power Supply, Industrial Control 定制型电阻 - 电源、工控类		
Custom -Power Supply, Industrial Control-1 定制型电阻器 - 电源、工控 -1	PHF, FTR, TFR	120
Custom -Power Supply, Industrial Control-2 定制型电阻器 - 电源、工控 -2	QHO, KNHW, KNHB	131
Custom -Power Supply, Industrial Control-3 定制型电阻器 - 电源、工控 -3	HPWR, HAWF	132
Custom -Power Supply, Industrial Control-4 定制型电阻器 - 电源、工控 -4	HAWR	133
Standard Packing of Cement Resistors 水泥电阻器包装规范		134
Test Methods and Explanation 测试方法和注释		
Test Methods 检测方法		137
Standard Nominal Resistance Values 标准阻值		138
Explanation of Part No. System 料号系统注释		141
Standard Color Code System 标准色码系统		143
电阻材料 Resistor material		
Ceramic Rod 瓷棒	OPD, OSD	146
Capped Ceramic Rod 组帽瓷棒	OSC	148
Carbon Film Capped Ceramic Rod 碳膜组帽棒	CRC, CRD	150
Metal Film Capped Ceramic Rod 金属膜组帽棒	MFC, MFD	152
Metal Oxide Film Capped Ceramic Rod 金属氧化膜组帽棒	MOC, MOD	154
Metal Glaze Capped Ceramic Rod 玻璃釉膜组帽棒	MGC, MGD	156
Chemical Nickel - Plating Film Capped Ceramic Rod 化学沉积膜组帽棒	CNC, CND	158
Zero ohm Copper Plated Rod 瓷棒镀铜膜	ZOC	160
Zero ohm-Tinned Iron Rod 0Ω 镀锡铁棒	TOEO	160
Tin-Plated Steel Cap 铁帽	TOC	162
Ceramic Case 瓷壳	CKO, CGO	163
LED Ceramic Substrate LED 陶瓷基板		
Thin-Film Ceramic Substrate - DPC 薄膜陶瓷基板	114.3×114.3mm×0.38/0.5/1.0mm	167

注：目录 / 网站参数表仅供一般参考。具体以我司提供的产品规格书为准，可根据要求提供所需产品。

Note: Catalog/website specifications are for general reference only. Detailed Product Specification shall take precedence & is available upon request.

Feature (特性)

- Small size & light weight 短小轻薄
- Reduction of assembly costs and matching with placement machine. 可降低装置成本及配合机器组装
- Suitable for both wave & re-flow soldering. 适合波峰焊与回流焊
- Applications: Navigator (GPS), Mobile Phone, Telecom, PDA, Setbox, Meter. 应用于GPS, 移动电话, PDA, 机顶盒, 仪表



Figures (形状)



Derating Curve & Specification

降功率曲线及性能

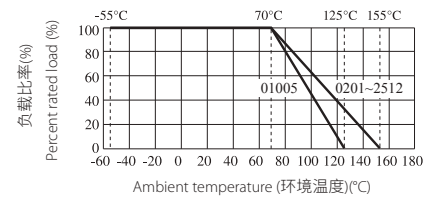

Type 类型	01005	0201	0402	0603	0805	1206	1210	1812	2010	2512
Size 尺寸	0402	0603	1005	1608	2012	3216	3225	4532	5025	6432
Max. Working Voltage 最大工作电压	15V	25V	50V	75V	150V	200V	200V	200V	200V	200V
Max. Overload Voltage 最大过负荷电压	30V	50V	100V	150V	300V	400V	500V	500V	500V	500V
Dielectric withstanding Voltage 绝缘耐压	-	-	100V	300V	500V	500V	500V	500V	500V	500V
Operating Temperature 工作温度范围	-55~+125°C	-55~+155°C	-55~+155°C	-55~+155°C	-55~+155°C	-55~+155°C	-55~+155°C	-55~+155°C	-55~+155°C	-55~+155°C

Type 类型	01005	0201	0402	0603	0805	1206	1210	1812	2010	2512	
Dimension 尺寸	L(mm)	0.40±0.02	0.60±0.03	1.00±0.10	1.60±0.10	2.00±0.15	3.10±0.15	3.10±0.10	4.50±0.20	5.00±0.10	6.35±0.10
	W(mm)	0.20±0.02	0.30±0.03	0.50±0.05	0.80±0.10	1.25 ^{+0.15} _{-0.10}	1.55 ^{+0.15} _{-0.10}	2.60±0.20	3.20±0.20	2.50±0.20	3.20±0.20
	H(mm)	0.13±0.02	0.23±0.03	0.35±0.05	0.45±0.10	0.55±0.10	0.55±0.10	0.55±0.10	0.55±0.20	0.55±0.10	0.55±0.10
	A(mm)	0.10±0.03	0.10±0.05	0.20±0.10	0.30±0.20	0.40±0.20	0.45±0.20	0.50±0.25	0.50±0.20	0.60±0.25	0.60±0.25
	B(mm)	0.10±0.03	0.15±0.05	0.25±0.10	0.30±0.20	0.40±0.20	0.45±0.20	0.50±0.20	0.50±0.20	0.50±0.20	0.50±0.20
Resistance Value of Jumper 零欧姆电阻阻值	<50mΩ										
Rated Current of Jumper 零欧姆电阻额定电流	0.5A	0.5A	1A	1A	2A	2A	2A	2A	2A	2A	
Max. Overload Current of Jumper 零欧姆电阻最大过负荷电流	1A	1A	2A	2A	5A	10A	10A	10A	10A	10A	

Type 类型	01005	0201	0402	0603	0805	1206	1210	1812	2010	2512	
Power Rating at 70°C 功率	1/32W	1/20W	1/16W	1/10W	1/8W	1/4W	1/4W	1/3W	1/2W	3/4W	1W
Resistance Range of 0.5%(E-96) 0.5% 的阻值范围 (E-96)	-	-	1Ω~10MΩ	1Ω~10MΩ	1Ω~10MΩ	-	1Ω~10MΩ	-	1Ω~10MΩ	1Ω~10MΩ	1Ω~10MΩ
Resistance Range of 1%,2%(E-96) 1%,2% 的阻值范围 (E-96)	10Ω ~ 10MΩ	1Ω~ 10MΩ	0.01Ω~ 10MΩ	0.1Ω≤R <10MΩ	0.01Ω ≤R <0.1 Ω	0.1Ω≤R <10MΩ	0.01Ω≤R <0.1Ω		0.01Ω~10MΩ		
Resistance Range of 5%(E-24) 5% 的阻值范围 (E-24)		1Ω~10MΩ	0.01Ω~ 10MΩ	0.1Ω≤R <10MΩ	0.01Ω ≤R <0.1 Ω	0.1Ω≤R <10MΩ	0.01Ω≤R <0.1Ω		0.01Ω~10MΩ		

Marking on the Resistors Body (电阻本体字码标示)

- For 01005, 0201, 0402 size, no marking on the body due to the small size of the resistor.
01005, 0201, 0402因电阻本体太小, 故本体无标示字码
- ±5% tolerance product: the marking is 3 digits, the first 2 digits are the significant of the resistance and the 3rd digit denotes number of zeros following.
±5%公差产品字码是三位数, 前二位是阻值的有效数, 第三位表示有几个0
- 0805, 1206, 1210, 2010, 2512 ≤±1%: the marking is 4 digits, the first 3 digits are the significant of the resistance and the 4th digit denotes number of zeros following.
0805, 1206, 1210, 2010, 2512 ≤±1%公差产品字码有四位数字, 前三位是阻值的有效数, 第四位表示有几个0
- Standard E-96 series values of 0603 ≤±1%: due to the small size of the resistor's body, 3 digits marking will be used to indicate the accurate resistance value by using the following Multiplier & Resistance Code.
0603 ≤±1%公差 E-96系列标准阻值, 因电阻本体太小, 采用三位阻值代码(数字)及下列指数代码(字母)配合来指明标准的阻值。



153 = 15000Ω = 15KΩ



Below 10Ω: 6R8 = 6.8Ω
10Ω 以下标示: 6R8 = 6.8Ω



2372 = 23700Ω = 23.7KΩ



Below 10Ω: 3R24 = 3.24Ω
10Ω 以下标示: 3R24 = 3.24Ω

Multiplier Code (for 0603 ≤±1% marking) [指数码 (0603≤±1% 标示)]

Code 代码	A	B	C	D	E	F	G	H	X	Y	Z
Power 幂	10 ⁰	10 ¹	10 ²	10 ³	10 ⁴	10 ⁵	10 ⁶	10 ⁷	10 ⁻¹	10 ⁻²	10 ⁻³

Standard E-96 series Resistance Value code (for 0603 ≤±1% marking) [E-96系列标准阻值代码 (对0603≤±1%的字码)]

Value 阻值	Code 代码	Value 阻值	Code 代码	Value 阻值	Code 代码	Value 阻值	Code 代码	Value 阻值	Code 代码	Value 阻值	Code 代码
100	01	147	17	215	33	316	49	464	65	681	81
102	02	150	18	221	34	324	50	475	66	698	82
105	03	154	19	226	35	332	51	487	67	715	83
107	04	158	20	232	36	340	52	499	68	732	84
110	05	162	21	237	37	348	53	511	69	750	85
113	06	165	22	243	38	357	54	523	70	768	86
115	07	169	23	249	39	365	55	536	71	787	87
118	08	174	24	255	40	374	56	549	72	806	88
121	09	178	25	261	41	383	57	562	73	825	89
124	10	182	26	267	42	392	58	576	74	845	90
127	11	187	27	274	43	402	59	590	75	866	91
130	12	191	28	280	44	412	60	604	76	887	92
133	13	196	29	287	45	422	61	619	77	909	93
137	14	200	30	294	46	432	62	634	78	931	94
140	15	205	31	301	47	442	63	649	79	953	95
143	16	210	32	309	48	453	64	665	80	976	96

So the resistance value are marked as the following examples (阻值标示如下):



1.96KΩ = 196 × 10¹ Ω = 29B



12.4Ω = 124 × 10⁻¹ = 10X

- Standard E-24 and not belong to E-96 series values (≤±1%) of 0603 size: the marking is the same as 5% tolerance but marking as underline.
0603≤±1%公差, 在标准 E-24 系列中, 但不属 E-96 系列的阻值, 标示和5%的公差相同, 但是在字码下多加一条线



122 = 1200 = 1.2 KΩ



680 = 68Ω

Performance Specifications (性能)

Temperature coefficient	温度系数	01005: $1\Omega \leq R < 10\Omega$: $-200 \sim +600 \text{ppm}/^\circ\text{C}$	0603: $0.01\Omega \leq R \leq 0.03\Omega$: $\pm 1500 \text{PPM}/^\circ\text{C}$
		$10\Omega \leq R < 100\Omega$: $\pm 300 \text{ppm}/^\circ\text{C}$	$0.03\Omega < R \leq 0.05\Omega$: $\pm 1000 \text{PPM}/^\circ\text{C}$
Short-time overload	短时间过负荷	$100\Omega \leq R \leq 10\text{M}\Omega$: $\pm 200 \text{ppm}/^\circ\text{C}$	$0.05\Omega < R < 1\Omega$: $\pm 800 \text{PPM}/^\circ\text{C}$
		0201: $1\Omega \leq R \leq 10\Omega$: $-100 \sim +350 \text{ppm}/^\circ\text{C}$	$1\Omega \leq R \leq 10\Omega$: $\pm 200 \text{PPM}/^\circ\text{C}$
Insulation resistance	绝缘电阻	$> 10\Omega$: $\pm 200 \text{ppm}/^\circ\text{C}$	$> 10\Omega$: $\pm 100 \text{PPM}/^\circ\text{C}$
		0402: $1\Omega \leq R \leq 10\Omega$: $\pm 200 \text{ppm}/^\circ\text{C}$	0805, 1206, 1210, 1812, 2010, 2512:
Dielectric withstanding voltage	绝缘耐压	$> 10\Omega$: $\pm 100 \text{ppm}/^\circ\text{C}$	$0.01\Omega \leq R \leq 0.015\Omega$: $\pm 1500 \text{ppm}/^\circ\text{C}$
		No evidence of flashover, mechanical damage, arcing or insulation breakdown 无击穿, 飞弧及可见机械性损伤	$0.015\Omega < R \leq 0.03\Omega$: $\pm 1000 \text{ppm}/^\circ\text{C}$
Terminal bending	端子弯曲	$\pm 1.0\% + 0.05\Omega$	$0.03\Omega < R < 1\Omega$: $\pm 800 \text{ppm}/^\circ\text{C}$
Soldering heat	耐焊接热	$\pm 1.0\% + 0.05\Omega$	$1\Omega \leq R \leq 10\Omega$: $\pm 200 \text{ppm}/^\circ\text{C}$
Solderability	可焊性	Coverage must be over 95%.	$> 10\Omega$: $\pm 100 \text{ppm}/^\circ\text{C}$
Rapid change of temperature	温度快速变化	$\pm 5\%, \pm 2\%: \pm(2.0\% + 0.05\Omega)$	
		$\pm 1\%, \pm 0.5\%: \pm(0.5\% + 0.05\Omega)$	
Humidity (Steady State)	恒定湿热	01005 $\pm 5\% \pm 1\%: \pm(2.0\% + 0.05\Omega)$	
		$\pm 5\%, \pm 2\%: \pm(3.0\% + 0.05\Omega)$	
Load life in humidity	湿度寿命	$\pm 1\%, \pm 0.5\%: \pm(1\% + 0.05\Omega)$	
		01005: $\pm(3.0\% + 0.05\Omega)$	
Load life	负载寿命	$\pm 5\%, \pm 2\%: \pm(3.0\% + 0.05\Omega)$	
		$\pm 1\%, \pm 0.5\%: \pm(1\% + 0.05\Omega)$	
		01005: $\pm(3.0\% + 0.05\Omega)$	

The values which are not of standard E-24 series (2% & 5%) and not of E-96 series (1%) could be offered on a case to case basis.
阻值如不在 E-24 系列 (2% & 5%) 及 E-96 系列 (1%) 可特别提供

Ordering Procedure (Example: 1206 1/4W 5% 1.2 Ω T/R-5000)

订购方式 (例如: 1206 1/4W 5% 1.2 Ω T/R-5000)



Remark: Please refer to page 141 for ordering guide. 注: 下单请详见 P141 页说明。

Feature (特性)

- High Resistance 高阻值
- Suitable for reflow & wave soldering
适合波峰焊与回流焊
- Application AV adapters, LCD back-light camera strobe etc. 适用于AV适配器, LCD背光电路, 照相机快门等.

Figures (型状)

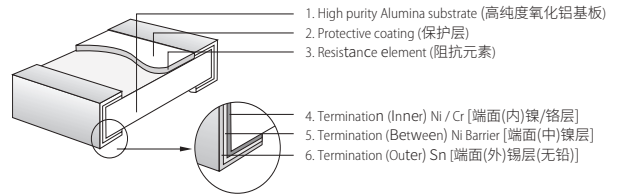
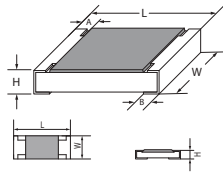

Derating Curve & Specification (降功率曲线及性能)



Type 类型	Max Working Voltage 最大工作电压	Max Overload Voltage 最大过负荷电压	Dielectric Withstanding Voltage 绝缘耐压	Operating Temperature Range 工作温度范围
0603	75V	150V	300V	-55~+155°C
0805	150V	300V	500V	
1206	200V	400V	500V	
1210	200V	500V	500V	

Type 类型	Size 尺寸	Power (功率) (70°C)	L (mm)	W (mm)	H (mm)	A (mm)	B (mm)	Resistance Range (阻值范围) 5% (E24)
0603	1608	1/10W	1.60±0.10	0.80±0.10	0.45±0.10	0.30±0.20	0.30±0.20	10M~100M
0805	2012	1/8W	2.00±0.15	1.25 ^{+0.15} _{-0.10}	0.55±0.10	0.40±0.20	0.40±0.20	
1206	3216	1/4W	3.10±0.15	1.55 ^{+0.15} _{-0.10}	0.55±0.10	0.45±0.20	0.45±0.20	
1210	3225	1/2W	3.10±0.10	2.60±0.20	0.55±0.10	0.50±0.25	0.50±0.20	

Performance Specification (性能)

Temperature coefficient	温度系数	±200ppm/°C
Short time overload	短时间过负荷	±(2.0%+0.05Ω)
Terminal bending	端子弯曲	±(1.0%+0.05Ω)
Solderability	可焊性	Coverage must be over 95%.
Dielectric withstanding voltage	绝缘耐压	No evidence of flashover, mechanical damage, arcing or insulation breakdown (无击穿, 飞弧及可见机械性损伤)
Soldering heat	耐焊接热	±(1.0%+0.05Ω)
Rapid change of temperature	温度快速变化	±(1.0%+0.05Ω)
Load Life in humidity	湿度寿命	±(3.0%+0.05Ω)
Load life	负载寿命	±(3.0%+0.05Ω)
Humidity (steady state)	恒定湿热	±(3.0%+0.05Ω)
Insulation resistance	绝缘电阻	≥1,000 MΩ

Feature (特性)

- High power in standard size
标准尺寸, 高功率
- Suitable for both wave & re-flow soldering
适合波峰焊与回流焊
- Application: AV adapters, LCD back-light, camera strobe etc. 适用于AV适配器, LCD背光电路, 照相机快门等

Figures (型状)



Derating Curve & Specification (降功率曲线及性能)



Type 类型	L(mm)	W(mm)	H(mm)	A(mm)	B(mm)
HP02 (0402)	1.00±0.10	0.50±0.05	0.35±0.05	0.20±0.10	0.25±0.10
HP03 (0603)	1.60±0.10	0.80±0.10	0.45±0.10	0.30±0.20	0.30±0.20
HP05 (0805)	2.00±0.15	1.25 ^{+0.15} _{-0.10}	0.55±0.10	0.40±0.20	0.40±0.20
HP06 (1206)	3.10±0.15	1.55 ^{+0.15} _{-0.10}	0.55±0.10	0.45±0.20	0.45±0.20
HP07 (1210)	3.10±0.10	2.60±0.20	0.55±0.10	0.50±0.25	0.50±0.20
HP10 (2010)	5.00±0.10	2.50±0.20	0.55±0.10	0.60±0.25	0.50±0.20
HP11 (1812)	4.50±0.20	3.20±0.20	0.55±0.20	0.50±0.20	0.50±0.20
HP12 (2512)	6.35±0.10	3.20±0.20	0.55±0.10	0.60±0.25	0.50±0.20

*Special offered 特别提供 : HP12 B:1.80±0.25mm

Type 类型	Size 尺寸	Power Rating at 70°C 功率	Resistance Range of 1% & 5% 1% & 5% 的阻值范围	Max. Working Voltage 最大工作电压	Max. Overload Voltage 最大过负荷电压	Dielectric Withstanding Voltage 绝缘耐压	Operating Temperature 工作温度范围
HP02	0402 (1005)	1/10W	1Ω~10M 0Ω	50V	100V Rmax=10mΩ, Imax=3A	100V	-55°C~155°C
HP03	0603 (1608)	1/5W	0.1Ω~10M 0Ω	75V	150V Rmax=8mΩ, Imax=5A	300V	
HP05	0805 (2012)	1/3W	10mΩ~10M 0Ω	150V	300V Rmax=5mΩ, Imax=6A	500V	
HP06	1206 (3216)	1/2W	10mΩ~10M 0Ω	200V	400V Rmax=5mΩ, Imax=10A	500V	
HP07	1210 (3225)	3/4W	0.1Ω~10M 0Ω	200V	500V Rmax=4mΩ, Imax=12A	500V	
HP10	2010 (5025)	1W	10mΩ~10M 0Ω	200V	500V Rmax=5mΩ, Imax=12A	500V	
HP11	1812 (4532)	1.25W	0.1Ω~10M 0Ω	200V	500V Rmax=5mΩ, Imax=12A	500V	
HP12	2512 (6432)	2W	10mΩ~10M 0Ω	250V	500V Rmax=5mΩ, Imax=16A	500V	

Performance Specifications (性能)

Temperature coefficient	温度系数
HP02: $1\Omega \leq R \leq 10\Omega$: ± 400 ppm/°C $10\Omega < R \leq 100\Omega$: ± 200 ppm/°C $100\Omega < R \leq 10M$: ± 100 ppm/°C	
HP03: $0.1\Omega \leq R < 0.2\Omega$: ± 200 ppm/°C $0.2\Omega \leq R \leq 10M$: ± 100 ppm/°C	
HP05: $10m\Omega \leq R \leq 15m\Omega$: ± 800 ppm/°C $15m\Omega < R \leq 25m\Omega$: ± 600 ppm/°C $25m\Omega < R \leq 50m\Omega$: ± 400 ppm/°C $50m\Omega < R < 0.1\Omega$: ± 200 ppm/°C $0.1\Omega \leq R \leq 10M$: ± 100 ppm/°C	
HP06: $10m\Omega \leq R < 15m\Omega$: ± 700 ppm/°C $15m\Omega \leq R < 30m\Omega$: ± 400 ppm/°C $30m\Omega \leq R < 50m\Omega$: ± 300 ppm/°C $50m\Omega \leq R < 0.1\Omega$: ± 150 ppm/°C $0.1\Omega \leq R \leq 10M$: ± 100 ppm/°C	
HP07, HP11: ± 100 ppm/°C	
HP10: $10m\Omega \leq R < 15m\Omega$: $0 \sim +800$ ppm/°C $15m\Omega \leq R < 50m\Omega$: $0 \sim +600$ ppm/°C $50m\Omega \leq R < 10M$: ± 100 ppm/°C	
HP12: $10m\Omega \leq R < 20m\Omega$: $0 \sim +800$ ppm/°C $20m\Omega \leq R \leq 50m\Omega$: $0 \sim +400$ ppm/°C $50m\Omega < R \leq 10M$: ± 75 ppm/°C	

Short-time overload	短时间过负荷	$\pm 5\%$: $\pm(2.0\% + 0.1\Omega)$ $\pm 1\%$: $\pm(1.0\% + 0.1\Omega)$
Dielectric withstanding voltage	绝缘耐压	No Evidence of flashover, mechanical damage, arcing or insulation breakdown 无击穿, 飞弧及可见机械性损伤
Terminal bending	端子弯曲	$\pm(1.0\% + 0.05\Omega)$
Soldering heat	耐焊接热	$\pm(1.0\% + 0.05\Omega)$
Solderability	可焊性	Coverage must be over 95%.
Rapid change of temperature	温度快速变化	$\pm 5\%$: $\pm(1.0\% + 0.05\Omega)$ $\pm 1\%$: $\pm(0.5\% + 0.05\Omega)$
Humidity (Steady state)	恒定湿热	$\pm 5\%$: $\pm(3.0\% + 0.1\Omega)$ $\pm 1\%$: $\pm(0.5\% + 0.1\Omega)$
Load life in humidity	湿度寿命	$\pm 5\%$: $\pm(3.0\% + 0.1\Omega)$ $\pm 1\%$: $\pm(1.0\% + 0.1\Omega)$
Load life	负载寿命	$\pm 5\%$: $\pm(3.0\% + 0.1\Omega)$ $\pm 1\%$: $\pm(1.0\% + 0.1\Omega)$

Ordering Procedure (Example: High Power HP06 1/2W 5% 120KΩ T/R-5000)

订购方式 (例如: 高功率 HP06 1/2W 5% 120KΩ T/R-5000)

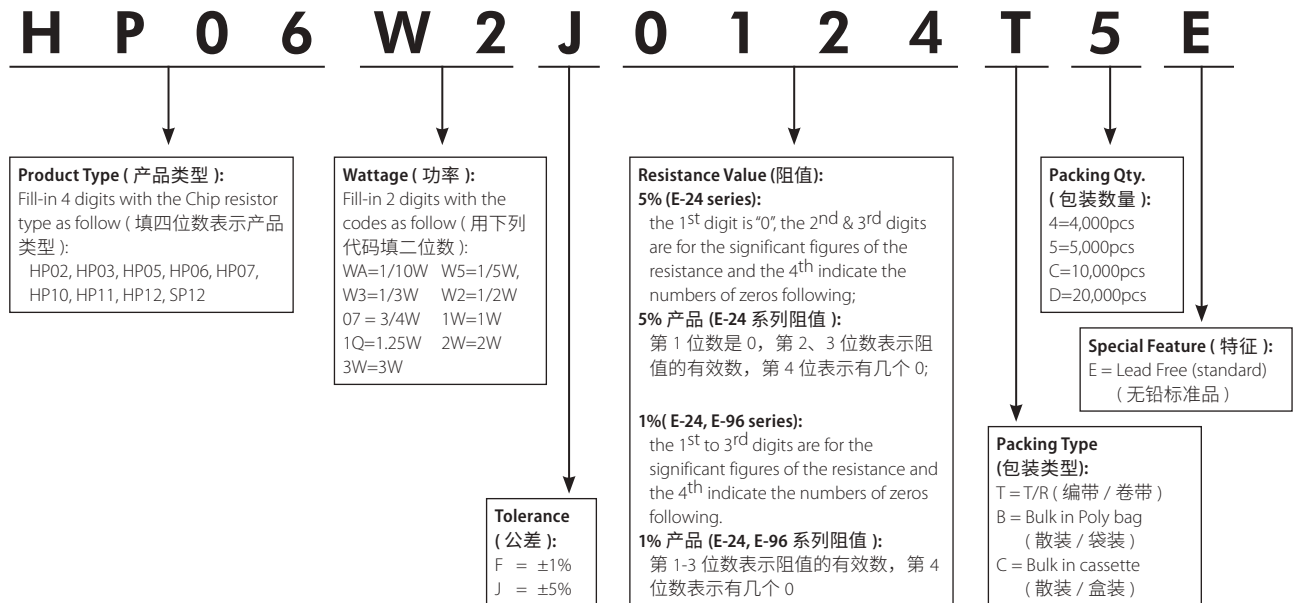

Remark: Please refer to page 141 for ordering guide. 注: 下单请详见 P141 页说明。

Feature (特性)

- High power rating up to 6 watts
高功率可达6W
- Suitable for both wave & re-flow soldering
适合波峰焊与回流焊
- Application LED lamps, Intelligent home appliances, Medical equipment, Kinds of industrial control devices & Industrial supplies
适用于LED 灯具、智能家电产品、医疗设备、各种工业控制装置及工业电源等

Figures (型状)

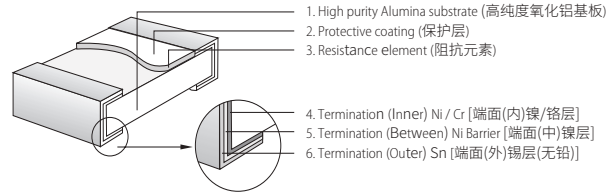

Derating Curve & Specification (降功率曲线及性能)



Type 类型	L(mm)	W(mm)	H(mm)	A(mm)	B(mm)
SP10 (2010)	5.00 ± 0.10	2.50 ± 0.15	1.10 ± 0.10	0.60 ± 0.25	0.50 ± 0.20
SP12 (2512)	6.35 ± 0.10	3.20 ± 0.15	1.10 ± 0.10	0.60 ± 0.25	1.80 ± 0.20
SP17 (2817)	7.10 ± 0.20	4.20 ± 0.20	1.10 ± 0.10	0.60 ± 0.20	1.80 ± 0.20
SP20 (4320)	11.00 ± 0.30	5.00 ± 0.25	1.10 ± 0.10	0.80 ± 0.20	2.40 ± 0.20
SP27 (4527)	11.60 ± 0.30	6.85 ± 0.25	1.10 ± 0.10	1.00 ± 0.20	2.50 ± 0.20

Type 类型	Size 尺寸	Power Rating at 70°C 功率	Resistance Range of 1% & 5% 1% & 5% 的阻值范围	Max. Working Voltage 最大工作电压	Max. Overload Voltage 最大过负荷电压	Dielectric Withstanding Voltage 绝缘耐压	Operating Temperature 工作温度范围
SP10	2010 (5025)	2W	1Ω ~ 10MΩ	200V	500V	500V	-55°C~155°C
SP12	2512 (6432)	3W		250V	500V	500V	
SP17	2817 (7142)	4W		250V	500V	500V	
SP20	4320 (1150)	5W		300V	600V	600V	
SP27	4527 (1267)	6W		300V	600V	600V	

Performance Specifications (性能)

Test Item 试验项目	Test Methods 试验方法	Evaluation Criteria 判定标准
Temperature coefficient 温度系数	Measure between -55°C ~+155°C 测定范围：-55°C ~+155°C	1Ω~10Ω ≤± 200PPM/°C 10.1Ω~10MΩ ≤± 100PPM/°C
Short-time overload 短时间过负荷	2.5x Rated voltage or Max. Overload Voltage whichever is lower for 5 seconds, then check the resistance. 2.5 倍额定电压或最大过负荷电压 (取其低者), 持续 5 秒钟, 然后测阻值。	± 5% (2.0% + 0.1Ω) ± 1% (1.0% + 0.1Ω)
Terminal Bending 端子弯曲	Bending Distance 3mm, Duration: 60s±5s, then check the resistance. 弯曲距离：3mm, 保持时间：60s±5s, 然后测试阻值。	± (1.0% + 0.05Ω)
Solderability 可焊性	Temperature of solder: 245±3°C; Dwell time in solder: 2~3seconds. 锡炉温度：245±3°C；浸入时间：2~3 秒。	Coverage must be over 95%. 覆盖率 ≥95%
Soldering heat 耐焊接热	Permanent resistor change when leads immersed to a point 2.0~2.5mm from the body in 260±5°C solder 10±1 seconds. 锡炉温度 260±5°C, 浸入深度：离本体导线根部约 2.0~2.5mm 处, 浸入时间：2~3 秒。	± (1.0%+0.05Ω)
Dielectric withstanding voltage 绝缘耐压	Resistor shall be clamped in the trough of 90° metallic V-block and shall be tested at AC potential respectively specified in the given list of each product type for 60~70s. 电阻固定在 90° 的 V 型槽中, 根据不同产品规定交流电压, 持续 60~70 秒。	No evidence of flashover, mechanical damage, arcing or insulation breakdown 无击穿, 飞弧及可见机械性损伤
Rapid change of temperature 温度快速变化	30 min at -55 °C and 30 min at 155 °C; 100 cycles -55 °C 温度放置 30min, 155 °C 温度放置 30min, 100 个循环； IEC 60115-1 4.19	± 5% (1.0% + 0.1Ω). ± 1% (0.5% + 0.1Ω).
Load life 负载寿命	70°C, at RCWV or Max.Working Voltage whichever less, 1,000 hours (1.5 hours "ON", 0.5 hours "OFF"), Measurement at 24±4 hours after test conclusion. 70°C, 额定工作电压或最大工作电压 (取其低者), 持续时间：1,000h (1.5h "通", 0.5h "断"), 试验结束 24h 后进行测试。 MIL-STD-202 Method 108	± 5% (3.0% + 0.1Ω). ± 1% (1.0% + 0.1Ω).
Humidity (Steady State) 恒定湿热	Temporary resistance change after 240 hours exposure in a humidity test chamber controlled at 40±2°C and 90~95% RH. 在 40±2°C 和 90~95% RH 相对湿度条件下, 存放 240h 后阻值变化率	± 5% (3.0% + 0.1Ω). ± 1% (0.5% + 0.1Ω)
Load life in humidity 湿度寿命	Resistance change after 1000 hours (1.5hours"ON", 0.5hours"OFF") at RCWV or Max.Working Voltage whichever less in a humidity test chamber controlled at 40±2°C and 90~95% RH. 持续时间：1000h (1.5h "通", 0.5h "断")；试验温度：40±2°C；相对湿度：90~95% RH；试验电压：额定工作电压或最大工作电压 (取其低者)。	± 5% (3.0% + 0.1Ω). ± 1% (1.0% + 0.1Ω)

Ordering Procedure (Example: SP12 3W (2512) ±1% 10Ω T/R-2,000)

订购方式 (例如: SP12 3W (2512) ±1% 10Ω T/R-2,000)



Remark: Please refer to page 141 for ordering guide. 注：下单请详见 P141 页说明。

Feature (特性)

- Superiority in Max. Working Voltage performance than general thick film Chip Resistors. 在最大工作电压上优于普通厚膜晶片电阻
- Suitable for both wave & re-flow soldering 适合波峰焊及回流焊
- Application: AV adapter, LCD Backlight, Flash Light of camera 适用于AV适配器、LCD背光电路、照相机的闪光灯等

Figures (型状)



Derating Curve & Specification (降功率曲线及性能)



Type 类型	Max. Working Voltage 最大工作电压	Max. Overload Voltage 最大过负荷电压	Dielectric Withstanding Voltage 绝缘耐压	Operating Temperature 工作温度范围
HV03	200V	400V	300V	-55°C~155°C
HV05	400V	800V	500V	
HV06	500V	1000V	500V	
HV07	800V	1500V	500V	
HV10	2000V	3000V	500V	
HV12	3000V	4000V	500V	

Type 类型	Size 尺寸	Power Rating 功率 at 70°C	L(mm)	W(mm)	H(mm)	A(mm)	B(mm)	Resistance Range 阻值范围 1% & 5%
HV03	0603 (1608)	1/10W	1.60±0.10	0.80±0.10	0.45±0.10	0.30±0.20	0.30± 0.20	36KΩ~10MΩ
HV05	0805 (2012)	1/8W	2.00±0.15	1.25 ^{+0.15} _{-0.10}	0.55±0.10	0.40±0.20	0.40± 0.20	100KΩ~10MΩ
HV06	1206 (3216)	1/4W	3.10±0.15	1.55 ^{+0.15} _{-0.10}	0.55±0.10	0.45±0.20	0.45±0.20	100KΩ~10MΩ
HV07	1210 (3225)	1/2W	3.10±0.10	2.60±0.20	0.55±0.10	0.50±0.25	0.50±0.20	50KΩ~10MΩ
HV10	2010 (5025)	3/4W	5.00±0.10	2.50±0.20	0.55±0.10	0.60±0.25	0.50±0.20	50KΩ~10MΩ
HV12	2512 (6432)	1W	6.35±0.10	3.20±0.20	0.55±0.10	0.60±0.25	0.50±0.20	39KΩ~10MΩ

The NV series of Anti-sulfuration products are available in particular. NV系列抗硫化产品可特别提供。

Performance Specification (性能)

Temperature coefficient	温度系数	±100PPM/°C
Short-time overload	短时间过负荷	±(2.0%+0.1Ω)
Terminal bending	端子弯曲	±(1.0%+0.05Ω)
Solderability	可焊性	Coverage must be over 95%.
Rapid change of temperature	温度快速变化	5% : ±(1.0%+0.05Ω) 1% : ±(0.5%+0.05Ω)
Humidity (Steady State)	恒定湿热	±(3.0%+0.1Ω)
Load life in humidity	湿度寿命	±(3.0%+0.1Ω)
Load life	负载寿命	±(3.0%+0.1Ω)
Insulation resistance	绝缘电阻	≥1,000MΩ
Dielectric withstanding voltage	绝缘耐压	No evidence of flashover, mechanical damage, arcing or insulation breakdown 无击穿, 飞弧及可见机械性损伤
Soldering heat	耐焊接热	±(1.0% + 0.05Ω)

Ordering Procedure (Example: High Voltage HV06 1/4W 5% 120KΩ T/R-5000)

订购方式 (例如: 高压 HV06 1/4W 5% 120KΩ T/R-5000)



Feature (特性)

- Superior Anti-Surge Voltage performance. 优越的抗浪涌电压特性
- Suitable for both wave & re-flow soldering 适合波峰焊与回流焊
- Application AV adapters, LCD back-light camera strobe etc. 适用于AV适配器、LCD背光电路、照相机的闸门等

Figures (型状)



Derating Curve (降功率曲线)

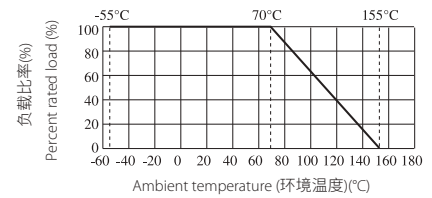

Curve of Pulse Duration (脉冲曲线)



Pulse Voltage Limit (电压曲线)



Specification (规格)

Type 类型	Size 尺寸	Max. Working Voltage 最大工作电压	Max. Overload Voltage 最大过负荷电压	Dielectric Withstanding Voltage 绝缘耐压	Operating Temperature 工作温度范围
AS02	0402 (1005)	50V	100V	100V	-55~+155°C
AS03	0603 (1608)	75V	150V	300V	
AS05	0805 (2012)	150V	300V	500V	
AS06	1206 (3216)	200V	400V	500V	
AS07	1210 (3225)	200V	500V	500V	
AS10	2010 (5025)	400V	800V	500V	
AS12	2512 (6432)	500V	1000V	500V	

Type 类型	Power (功率) (70°C)	L (mm)	W (mm)	H (mm)	A (mm)	B (mm)	Resistance Range 阻值范围	Tolerance 公差
AS02	1/8W	1.00±0.10	0.50±0.05	0.35±0.05	0.20±0.10	0.25±0.10	1Ω~10M	±5% ±10% ±20%
AS03	1/4W	1.60±0.10	0.80±0.10	0.45±0.10	0.30±0.20	0.30±0.20		
AS05	1/2W	2.00±0.15	1.25 ^{+0.15} _{-0.10}	0.55±0.10	0.40±0.20	0.40±0.20		
AS06	0.6W	3.10±0.15	1.55 ^{+0.15} _{-0.10}	0.55±0.10	0.45±0.20	0.45±0.20		
AS07	3/4W	3.10±0.10	2.60±0.20	0.55±0.10	0.50±0.25	0.50±0.20		
AS10	1.5W	5.00±0.10	2.50±0.20	0.55±0.10	0.60±0.25	0.50±0.20		
AS12	2W	6.35±0.10	3.20±0.20	0.55±0.10	0.60±0.25	0.50±0.20		

*Special offered 特别提供: AS12 B:1.80±0.25mm

Performance Specifications (性能)

Temperature coefficient	温度系数	1Ω≤R≤10Ω: ±400ppm/°C 10Ω<R≤10M: ±100ppm/°C
Short-time overload	短时间过负荷	±(1.0%+0.1Ω)
Terminal bending	端子弯曲	±(1.0%+0.05Ω)
Solderability	可焊性	Coverage must be over 95%.
Dielectric withstanding voltage	绝缘耐压	No evidence of flashover, mechanical damage, arcing or insulation breakdown 无击穿, 飞弧及可见机械性损伤
Soldering heat	耐焊接热	±(1.0%+0.05Ω)
Rapid change of temperature	温度快速变化	±(1.0%+0.05Ω)
Load Life in humidity	湿度寿命	±(3.0%+0.1Ω)
Load life	负载寿命	±(3.0%+0.1Ω)
Humidity (Steady State)	恒定湿热	±(3.0%+0.1Ω)
Single pulse	单脉冲	±(1.0%+0.1Ω)

Ordering Procedure (Example: Anti-surge AS03 1/4W 5% 10KΩ T/R-5000)

订购方式 (例如: 抗浪涌 AS03 1/4W 5% 10KΩ T/R-5000)

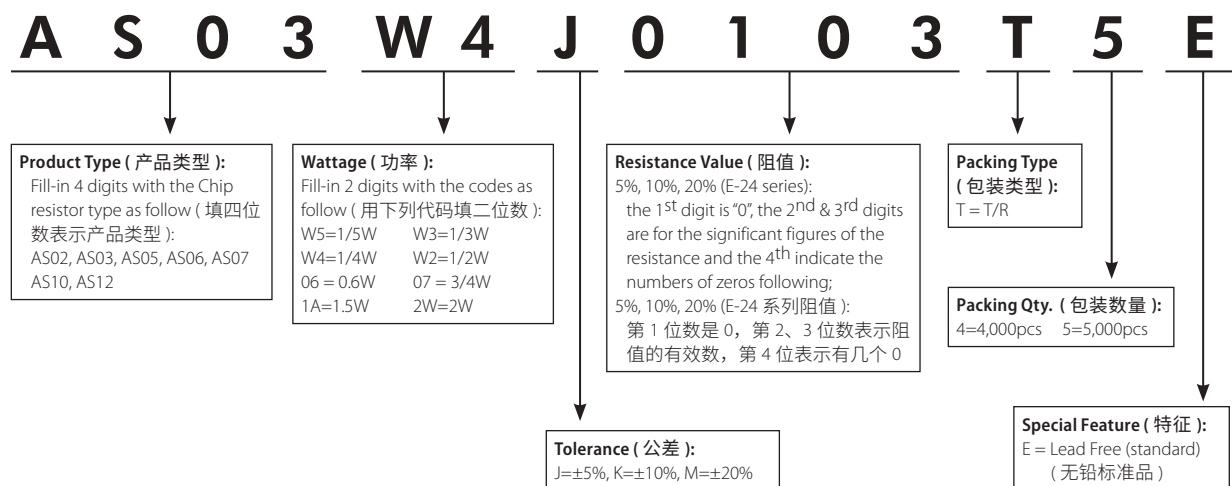

Feature (特性)

- High-Precision, high-power, anti-pulse 高精度、高功率、抗脉冲
- Suitable for reflow & wave soldering 适合波峰焊与回流焊
- Application monitors, power supplies, camcorder, laptop computer 适用于显示器、电源、手提电脑



Figures (型状)



Derating Curve (降功率曲线)



Curve of Pulse Duration (脉冲曲线)



Pulse Voltage Limit (电压曲线)



Specification (性能)

Type 类型	Size 尺寸	Max working voltage 最大工作电压	Max Overload Voltage 最大过负荷电压	Dielectric Withstanding Voltage 绝缘耐压	Operating Temperature 工作温度范围
PS02	0402 (1005)	50V	100V	100V	-55~+155°C
PS03	0603 (1608)	50V	100V	300V	
PS05	0805 (2012)	150V	300V	500V	
PS06	1206 (3216)	200V	400V	500V	
PS07	1210 (3225)	200V	500V	500V	
PS10	2010 (5025)	400V	800V	500V	
PS12	2512 (6432)	500V	1000V	500V	

Type 类型	Power 功率 (70°C)	L (mm)	W (mm)	H (mm)	A (mm)	B (mm)	Resistance Range 阻值范围 1%(E96), 5%(E24)
PS02	1/8W	1.00±0.10	0.50±0.05	0.35±0.05	0.20±0.10	0.25±0.10	1Ω~10M
PS03	1/4W	1.60±0.10	0.80±0.10	0.45±0.10	0.30±0.20	0.30±0.20	
PS05	1/3W	2.00±0.15	1.25 ^{+0.15} _{-0.10}	0.55±0.10	0.40±0.20	0.40±0.20	0.1Ω~10M
PS06	1/2W	3.10±0.15	1.55 ^{+0.15} _{-0.10}	0.55±0.10	0.45±0.20	0.45±0.20	
PS07	3/4W	3.10±0.10	2.60±0.20	0.55±0.10	0.55±0.25	0.50±0.20	1Ω~10M
PS10	1.25W	5.00±0.10	2.50±0.20	0.55±0.10	0.60±0.25	0.50±0.20	
PS12	2W	6.35±0.10	3.20±0.20	0.55±0.10	0.60±0.25	0.50±0.20	0.1Ω~10M

*Special offered 特别提供 : PS12 B:1.80±0.25mm

Performance Specification (性能)

Temperature coefficient	温度系数	PS02: 1Ω~10Ω: ±400PPM/°C 11Ω~100Ω: ±200PPM/°C >100Ω: ±100PPM/°C PS03, PS05, PS06, PS07, PS10, PS12: ±100ppm/°C
Short-time overload	短时间过负荷	±1%±(1.0%+0.1Ω) ±5%±(2.0%+0.1Ω)
Terminal bending	端子弯曲	±(1.0%+0.05Ω)
Solderability	可焊性	Coverage must be over 95%.
Soldering heat	耐焊接热	±(1.0% + 0.05Ω)
Load life in humidity	湿度寿命	±1%±(1.0%+0.1Ω) ±5%±(3.0%+0.1Ω)
Dielectric withstanding voltage	绝缘耐压	No evidence of flashover, mechanical damage, arcing or insulation breakdown 无击穿, 飞弧及可见机械性损伤
Rapid change of temperature	温度快速变化	±1%±(0.5%+0.1Ω) ±5%±(3.0%+0.1Ω)
Load life	负载寿命	±1%±(1.0%+0.1Ω) ±5%±(3.0%+0.1Ω)
Single pulse	单脉冲	±(1.0%+0.1Ω)

Ordering Procedure (Example: PS05 1/3W 5% 120KΩ T/R-5000)

订购方式 (例如: PS05 1/3W 5% 120KΩ T/R-5000)



Remark: Please refer to page 141 for ordering guide. 注: 下单请详见 P141 页说明。

Feature (特性)

- Low T.C.R $\pm 50\text{PPM}/^\circ\text{C}$ 低T.C.R $\pm 50\text{PPM}/^\circ\text{C}$
- Suitable for reflow & wave soldering 适合波峰焊与回流焊
- Application Precision medical equipment, Auto industrial control system, Communication equipment, IPAD, Portable computer, LED lamps, Intelligent home appliances
适用于精密医疗器械、自动工业控制系统、通讯设备、IPAD、手提电脑、LED灯具、智能家电产品等

Derating Curve (降功率曲线)

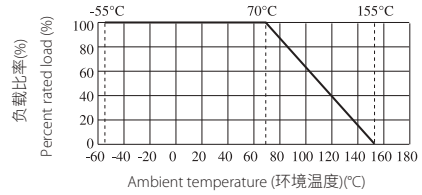

Figures (型状)

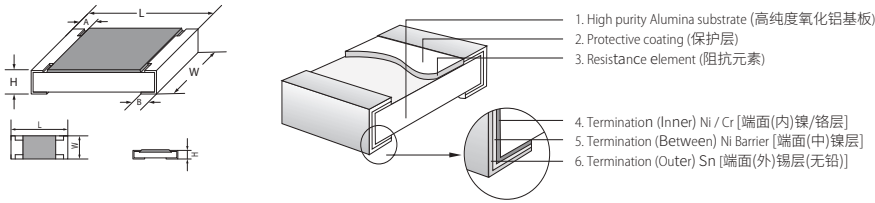

Specification (性能)

Type 类型	Size 尺寸	Max working voltage 最大工作电压	Max Overload Voltage 最大过负荷电压	Dielectric Withstanding Voltage 绝缘耐压	Operating Temperature 工作温度范围
LT02	0402 (1005)	50V	100V	100V	-55~+155°C
LT03	0603 (1608)	75V	150V	300V	
LT05	0805 (2012)	150V	300V	500V	
LT06	1206 (3216)	200V	400V	500V	

Type 类型	Power 功率 (70°C)	L (mm)	W (mm)	H (mm)	A (mm)	B (mm)	Resistance Range 阻值范围 0.25%, 0.5%, 1%
LT02	1/16W	1.00±0.10	0.50±0.05	0.35±0.05	0.20±0.10	0.25±0.10	100Ω~1MΩ
LT03	1/10W	1.60±0.10	0.80±0.10	0.45±0.10	0.30±0.20	0.30±0.20	1Ω~1MΩ
LT05	1/8W	2.00±0.15	1.25 ^{+0.15} _{-0.10}	0.55±0.10	0.40±0.20	0.40±0.20	
LT06	1/4W	3.10±0.15	1.55 ^{+0.15} _{-0.10}	0.55±0.10	0.45±0.20	0.45±0.20	

Performance Specifications (性能)

Temperature coefficient	温度系数	LT02: $\pm 50\text{ppm}/^\circ\text{C}$ LT03: $1\Omega \leq R \leq 10\Omega$: $\pm 100\text{ppm}/^\circ\text{C}$ $10\Omega < R \leq 1\text{M}\Omega$: $\pm 50\text{ppm}/^\circ\text{C}$ LT05: $1\Omega \leq R \leq 10\Omega$: $\pm 100\text{ppm}/^\circ\text{C}$ $10\Omega < R \leq 1\text{M}\Omega$: $\pm 50\text{ppm}/^\circ\text{C}$ LT06: $1\Omega \leq R \leq 10\Omega$: $\pm 100\text{ppm}/^\circ\text{C}$ $10\Omega < R \leq 1\text{M}\Omega$: $\pm 50\text{ppm}/^\circ\text{C}$
Short-time overload	短时间过负荷	$\pm(1.0\%+0.05\Omega)$
Terminal Bending	端子弯曲	$\pm(1.0\%+0.05\Omega)$
Solderability	可焊性	Coverage must be over 95%.
Soldering heat	耐焊接热	$\pm(1.0\%+0.05\Omega)$
Humidity (Steady State)	恒定温热	$\pm(0.5\%+0.05\Omega)$
Load life	负载寿命	$\pm(1.0\%+0.05\Omega)$

Ordering Procedure (Example: LT02 1/16W 1% 100KΩ T/R-10000)

订购方式 (例如: LT02 1/16W 1% 100KΩ T/R-10000)



Feature (特性)

- Tolerance 精度为: $\pm 0.5\% \sim \pm 5\%$
- Flex LED strip use thick film chip resistor 软灯条专用电阻
- Resistance range 阻值范围为: $10\Omega \sim 820\Omega$
- Operating temperature range 工作温度范围为: $-55^{\circ}\text{C} \sim +155^{\circ}\text{C}$
- Stable electrical capability ,high reliability 电性能稳定,可靠性高
- Suit for reflow 适合于回流焊焊接
- Low assembly cost, suit for automatic SMT equipment 装配成本低,并与自动装贴设备匹配
- Superior mechanical strength and high frequency characteristics 机械强度高、高频特性优越
- According with ROHS standard and Halogen-free 符合ROHS,无卤

Dimension (尺寸) mm



Derating Curve (降功率曲线)



Type 类型	Size 尺寸	Max Working Voltage 最大工作电压	Max Overload Voltage 最大过负荷电压	Temperature Coefficient 温度系数	Dielectric Withstanding Voltage 绝缘耐压	Operating Temperature Range 工作温度范围
LE05	0805	200V	400V	$\pm 200\text{PPM}/^{\circ}\text{C}$	500V	$-55 \sim +155^{\circ}\text{C}$
LE06	1206					

Type 类型	Size 尺寸	Power (功率) (70°C)	L (mm)	W (mm)	H (mm)	A (mm)	B (mm)	Resistance Range (阻值范围)
LE05	0805	1/8W	2.00 ± 0.15	$1.25^{+0.15}_{-0.10}$	0.55 ± 0.10	≤ 1.0	0.40 ± 0.20	$10\Omega \sim 820\Omega$
LE06	1206	1/4W	3.10 ± 0.15	$1.55^{+0.15}_{-0.10}$	0.55 ± 0.10	≤ 1.0	0.50 ± 0.20	

Performance Specifications (性能)

Temperature coefficient	温度系数	±200ppm/°C
Short time overload	短时间过负荷	±1%: ±(1%+0.1Ω) ±5%: ±(2%+0.1Ω)
Insulation resistance	绝缘电阻	≥ 1,000 MΩ
Dielectric withstanding voltage	绝缘耐压	No evidence of flashover, mechanical damage, arcing or insulation breakdown 无击穿, 飞弧及可见机械性损伤
Terminal bending	端子弯曲	±(1.0% + 0.05Ω)
Soldering heat	耐焊接热	±(1.0% + 0.005Ω)
Solderability	可焊性	Coverage must be over 95%.
Rapid change of temperature	温度快速变化	±1%: ±(1%+0.1Ω) ±5%: ±(3%+0.1Ω)
Humidity (Steady State)	恒定湿热	±1%: ±(0.5%+0.1Ω) ±5%: ±(3%+0.1Ω)
Load life in humidity	湿度寿命	±1%: ±(1%+0.05Ω) ±5%: ±(3%+0.05Ω)
Load life	负载寿命	±1%: ±(1%+0.1Ω) ±5%: ±(3%+0.1Ω)

Ordering Procedure (Example: LE06 1/4W 5% 1.2 Ω T/R-5000)

订购方式 (例如: LE06 1/4W 5% 1.2 Ω T/R-5000)



Feature (特性)

- High power & Wide terminal 高功率, 宽电极
- Suitable for both wave & re-flow soldering 适合波峰焊及回流焊
- Application: AV adapters, LCD back-light, camera strobe etc.
适用于AV适配器, LCD背光电路, 照相机快门等

Figures (型状)



1. Protective layer (保护层)
2. Resistive element (阻抗元素)
3. Termination (Inner) Ni / Cr [端面(内)镍/铬层]
4. Termination (Between) Ni [端面(中)镍层]
5. Termination (Outer) Sn [端面(外)锡层(无铅)]
6. High purity Alumina substrate (高纯度氧化铝基板)

Derating Curve & Specification (降功率曲线及性能)



Type 类型	L (mm)	W(mm)	H(mm)	A(mm)	B(mm)
WR08(0508)	1.20±0.10	2.0±0.10	0.55±0.10	0.20±0.10	0.30±0.20
WR12(0612)	1.60±0.15	3.20±0.15	0.55±0.10	0.30±0.20	0.45±0.20
WR20(1020)	2.50±0.15	5.00±0.15	0.55±0.10	0.40±0.20	0.60±0.20
WR18(1218)	3.10±0.10	4.60±0.15	0.55±0.10	0.45±0.20	0.40±0.20
WR25(1225)	3.10±0.15	6.25±0.15	0.55±0.10	0.45±0.20	0.65±0.20

Type 类型	Size 尺寸	Power 功率 70°C	Resistance Range 阻值范围		Max. Working Voltage 最大工作电压 / 电流	Max. Overload Voltage 最大过负荷电压 / 电流	Dielectric Withstanding Voltage 绝缘耐压	Operating Temperature 工作温度范围	T.C.R 温度系数 PPM/°C
			1%	5%					
WR08	0508 (1220)	1/3W	10Ω~1M		150V	300V			10R: ±400 10Ω<R≤100Ω±200 >100Ω:±100
		2/3W	10mΩ~10Ω		/	/			10mΩ≤R<30mΩ:0~+400 30mΩ≤R≤10Ω:0~+150
		/	<50mΩ		4A	8A		/	
WR12	0612 (1632)	1/2W	10Ω<R≤1M		200V	400V			10Ω<R≤100Ω±200 >100Ω:±100
		1W	10mΩ≤R≤10Ω		/	/			10mΩ≤R<100mΩ:0~+200 100mΩ≤R≤10Ω:0~+150
		/	<50mΩ		5A	10A		/	
WR20	1020 (2550)	1W	10Ω~1M	1Ω~1M	200V	400V	500V	-55°C ~155°C	1Ω<R≤10Ω±400 10Ω<R≤100Ω±200 >100Ω:±100
			10mΩ~1Ω		/	/			10mΩ≤R<30mΩ:0~+200 30mΩ≤R≤1Ω:0~+100
		/	<50mΩ		6A	12A		/	
WR18	1218 (3245)	1W	10mΩ~1M		200V	400V			10mΩ≤R<30mΩ:0~+200 30mΩ≤R≤1Ω:0~+100 1Ω<R≤10Ω±400 10Ω<R≤100Ω±200 >100Ω:±100
		/	<50mΩ		6A	10A		/	
			1Ω<R≤1M		200V	400V			1Ω<R≤10Ω±400 10Ω<R≤100Ω±200 >100Ω:±100
WR25	1225 (3264)	2W	1Ω<R≤1M		200V	400V			1Ω<R≤10Ω±400 10Ω<R≤100Ω±200 >100Ω:±100
		3W	10mΩ≤R≤1Ω		/	/			10mΩ≤R<30mΩ:0~+200 30mΩ≤R≤1Ω:0~+100
		/	<50mΩ		6A	15A		/	

Performance Specification (性能)

Short-time overload	短时间过负荷	±5%: $\pm(2.0\% \pm 0.005\Omega)$ ±1%: $\pm(1.0\% \pm 0.005\Omega)$
Dielectric withstanding voltage	绝缘耐压	No evidence of flashover mechanical damage, arcing or insulation break down. 无击穿, 飞弧及可见机械性损伤
Terminal bending	端子弯曲	$\pm (1.0\% \pm 0.005\Omega)$
Soldering heat	耐焊接热	$\pm (1.0\% \pm 0.005\Omega)$
Solderability	可焊性	Coverage must be over 95%.
Rapid change of temperature	温度快速变化	±5%: $\pm(1.0\% \pm 0.005\Omega)$ ±1%: $\pm(0.5\% \pm 0.005\Omega)$
Load life in humidity	湿度寿命	±5%: $\pm(3.0\% \pm 0.005\Omega)$ ±1%: $\pm(1.0\% \pm 0.005\Omega)$
Load life	负载寿命	±5%: $\pm(3.0\% \pm 0.005\Omega)$ ±1%: $\pm(1.0\% \pm 0.005\Omega)$

Ordering Procedure (Example: Wide Terminal WR18 1W 5% 120KΩ T/R-4000)

订购方式 (例如: 宽电极WR18 1W 5% 120KΩ T/R-4000)



Feature (特性)

- Apply to stable circuit instead of regulating circuit to adjust the application of resistance (laser adjusting resistance machine in client end)
适用于稳定电路中, 代替调节电路来调节阻值的应用(客户端激光调阻机)
- Superior heat & humidity withstanding performance 良好的耐高温耐湿性

Figures (型状)



Derating Curve & Specification (降功率曲线及性能)



Type 类型	Max. Working Voltage 最大工作电压	Max. Overload Voltage 最大过负荷电压	Operating Temperature 工作温度范围
TR03	75V	150V	-55°C~155°C
TR05	150V	300V	-55°C~155°C
TR06	200V	400V	-55°C~155°C

Type 类型	Size 尺寸	Power Rating 功率 70°C	L(mm)	W(mm)	H(mm)	A(mm)	B(mm)	Tolerance 公差	Resistance Range 阻值范围 (E-12)
TR03	0603 (1608)	1/10W	1.60±0.10	0.80±0.10	0.45±0.10	0.30±0.20	0.30±0.20	R: 0~30% Q: 0~20% T: 0~10% S: -10~0% N: -20~0% P: -30~0% J: ±5% K: ±10% M: ±20%	1Ω~1M
TR05	0805 (2012)	1/8W	2.00±0.15	1.25 ^{+0.15} _{-0.10}	0.55±0.10	0.40±0.20	0.40±0.20		
TR06	1206 (3216)	1/4W	3.10±0.15	1.55 ^{+0.15} _{-0.10}	0.55±0.10	0.45±0.20	0.45±0.20		

Performance Specification (性能)

Temperature coefficient 温度系数	TR03: 1Ω≤R≤10Ω: ±400ppm/°C >10Ω: ±200ppm/°C TR05, TR06: ±200PPM/°C
Short-time overload 短时间过负荷	±(2.0%+0.1Ω)
Terminal bending 端子弯曲	±(1.0%+0.05Ω)
Solderability 可焊性	Coverage must be over 95%.
Soldering heat 耐焊接热	±(1.0%+0.05Ω)
Rapid change of temperature 温度快速变化	±(1.0%+0.05Ω)
Load life in humidity 湿度寿命	±(3.0%+0.1Ω)
Load life 负载寿命	±(3.0%+0.1Ω)

Ordering Procedure (Example: Trimmable TR06 1/4W ±20% 120KΩ T/R-5000)

订购方式 (例如: 可调 TR06 1/4W ±20% 120KΩ T/R-5000)

The values which are not of standard E-12 series could be offered on a case to case basis.
阻值如不在 E-12 系列的可特别提供。

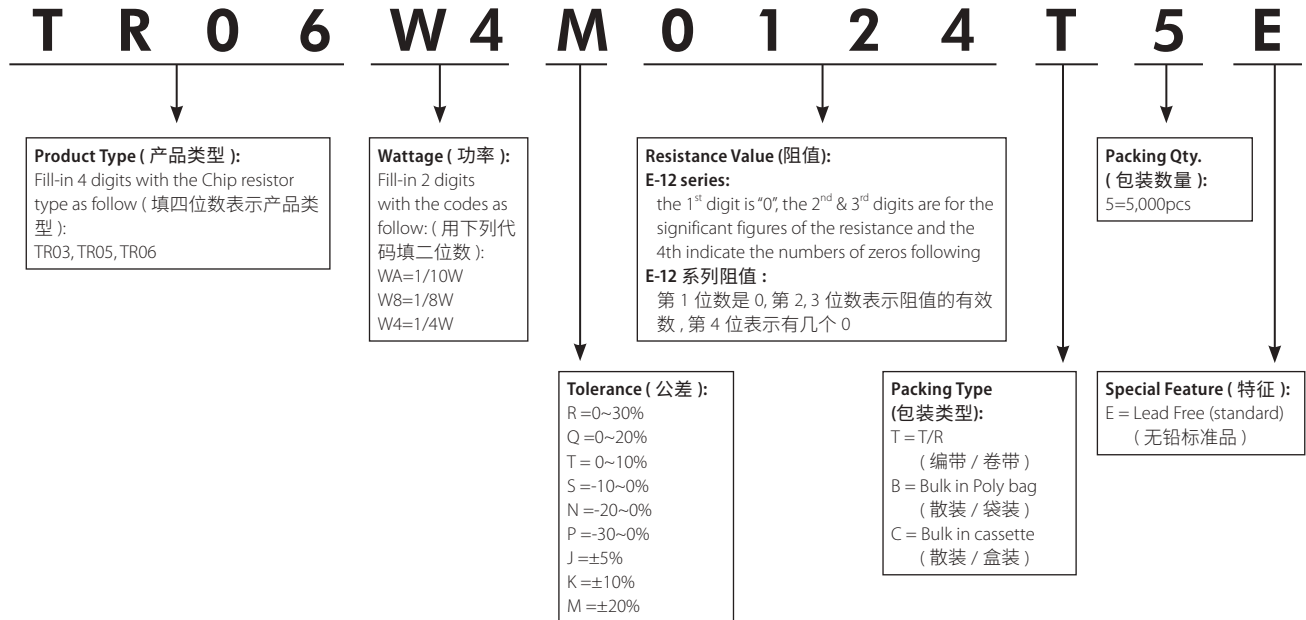

Feature (特性)

- Anti-Electro Static Discharge 抗静电
- High voltage 耐高压
- Suitable for reflow & wave soldering 适合波峰焊与回流焊
- Application Medical Devices, Industrial Controls, AV adapter, Flash lamp of camera, Automotive Industry, Outdoor Equipments
适用于医疗器械、工业控制、电源适配器、照相机的闪光灯、汽车工业及户外设备等

Derating Curve (降功率曲线)



Figures (型状)



Specification (性能)

Type 类型	Size 尺寸	Max working voltage 最大工作电压	Max Overload Voltage 最大过负荷电压	Dielectric Withstanding Voltage 绝缘耐压	Operating Temperature 工作温度范围
ES01	0201 (0603)	25V	50V	/	-55~+155°C
ES02	0402 (1005)	50V	100V	100V	
ES03	0603 (1608)	150V	200V	300V	
ES05	0805 (2012)	200V	400V	500V	
ES06	1206 (3216)	500V	1000V	500V	
ES07	1210 (3225)	800V	1500V	500V	

Type 类型	Power 功率 (70°C)	L (mm)	W (mm)	H (mm)	A (mm)	B (mm)	Resistance Range 阻值范围 1% & 5%
ES01	1/20W	0.60±0.03	0.30±0.03	0.23±0.03	0.10±0.05	0.15±0.05	1Ω~10MΩ
ES02	1/16W	1.00±0.10	0.50±0.05	0.35±0.05	0.20±0.10	0.25±0.10	
ES03	1/4W	1.60±0.10	0.80±0.10	0.45±0.10	0.30±0.20	0.30±0.20	
ES05	2/5W	2.00±0.15	1.25 ^{+0.15} _{-0.10}	0.55±0.10	0.40±0.20	0.40±0.20	
ES06	2/3W	3.10±0.15	1.55 ^{+0.15} _{-0.10}	0.55±0.10	0.45±0.20	0.45±0.20	
ES07	1/2W	3.10±0.10	2.60±0.20	0.55±0.10	0.50±0.25	0.50±0.20	

Performance Specifications (性能)

Temperature coefficient	温度系数	ES01: 1Ω≤R≤10Ω: ±400ppm/°C 10Ω<R≤10MΩ: ±200ppm/°C ES02~ES07: 1Ω≤R≤10Ω: ±200ppm/°C 10Ω<R≤10MΩ: ±100ppm/°C	Humidity (Steady State)	恒定温热	±1%±(0.5%+0.1Ω) ±5%±(3.0%+0.1Ω)
Short-time overload	短时间过负荷	±1%±(1.0%+0.1Ω) ±5%±(2.0%+0.1Ω)	Dielectric withstanding voltage	绝缘耐压	No evidence of flashover, mechanical damage, arcing or insulation breakdown 无击穿, 电弧及可见机械性损伤
Terminal Bending	端子弯曲	±(1.0%+0.05Ω)	Rapid change of temperature	温度快速变化	±1%±(0.5%+0.05Ω) ±5%±(1.0%+0.05Ω)
Solderability	可焊性	Coverage must be over 95%.	Load life	负载寿命	±1%±(1.0%+0.1Ω) ±5%±(3.0%+0.1Ω)
Soldering heat	耐焊接热	±(1.0%+0.05Ω)	ESD	抗静电	±(1.0%+0.05Ω)

ESD Limiting Voltage Curve (抗静电曲线)



NOTE 备注: HBM:100PF 1K5 1Cycle; MM:200PF 0Q 1Cycle

Ordering Procedure (Example: ES06 2/3W 5% 1.2Ω T/R-5000)

订购方式 (例如: ES06 2/3W 5% 1.2Ω T/R-5000)



Feature (特性)

- Non-magnetic 无磁性
- Suitable for reflow & wave soldering 适合波峰焊与回流焊
- Application Mobile Phone, PDA, Setbox, Meter 适用于移动电话、PDA、机顶盒、仪表

Figures (型状)



Derating Curve (降功率曲线)



Specification (性能)

Type 类型	Size 尺寸	Max working voltage 最大工作电压	Max Overload Voltage 最大过负荷电压	Operating Temperature 工作温度范围
NM02	0402 (1005)	50V	100V	-55~+155°C
NM03	0603 (1608)	75V	150V	
NM05	0805 (2012)	150V	300V	
NM06	1206 (3216)	200V	400V	
NM12	2512 (6432)	200V	500V	

Type 类型	Power 功率 (70°C)	L (mm)	W (mm)	H (mm)	A (mm)	B (mm)	Resistance Range 阻值范围 1%(E96), 5%(E24)
NM02	1/16W	1.00±0.10	0.50±0.05	0.35±0.05	0.20±0.10	0.25±0.10	1Ω~10M
NM03	1/10W	1.60±0.10	0.80±0.10	0.45±0.10	0.30±0.20	0.30±0.20	
NM05	1/8W	2.00±0.15	1.25 ^{+0.15} _{-0.10}	0.55±0.10	0.40±0.20	0.40±0.20	
NM06	1/4W	3.10±0.15	1.55 ^{+0.15} _{-0.10}	0.55±0.10	0.45±0.20	0.45±0.20	
NM12	1W	6.35±0.10	3.20±0.20	0.55±0.10	0.60±0.25	0.50±0.20	

Performance Specification (性能)

Temperature coefficient 温度系数	1Ω≤R≤10 Ω: ±400ppm/°C 10Ω<R≤100 Ω: ±200ppm/°C R>100Ω: ±100ppm /°C
Short-time overload 短时间过负荷	±1%:±(1.0%+0.1Ω) ±5%:±(2.0%+0.1Ω)
Terminal bending 端子弯曲	±(1.0%+0.05Ω)
Solderability 可焊性	Coverage must be over 95%.
Soldering heat 耐焊接热	±(1.0%+0.05Ω)
Humidity (Steady State) 恒定湿热	±1%:±(0.5%+0.1Ω) ±5%:±(3.0%+0.1Ω)
Dielectric withstanding voltage 绝缘耐压	No evidence of flashover, mechanical damage, arcing or insulation breakdown 无击穿, 飞弧及可见机械性损伤
Rapid change of temperature 温度快速变化	±1%:±(0.5%+0.05Ω) ±5%:±(1.0%+0.05Ω)
Load life 负载寿命	±1%:±(1.0%+0.1Ω) ±5%:±(3.0%+0.1Ω)

Ordering Procedure (Example: NM02 1/16W 5% 1.2 Ω T/R-10000)

订购方式 (例如: NM02 1/16W 5% 1.2 Ω T/R-10000)



Feature (特性)

- Total Lead Free in whole resistor body 电阻本体完全不含铅
- Small size and light weight 体积小、重量轻
- Reduction of assembly costs and matching with placement machine 可降低装置成本及配合机器组装
- Suitable for both wave & re-flow soldering 适合波峰焊与回流焊

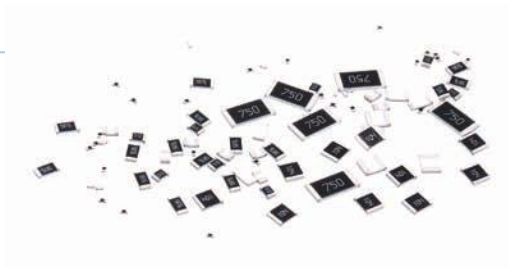

Figures (型状)

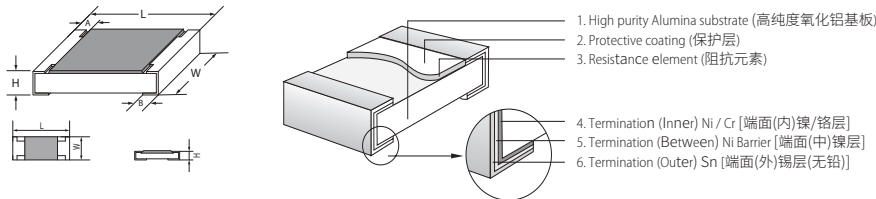

Derating Curve (降功率曲线)

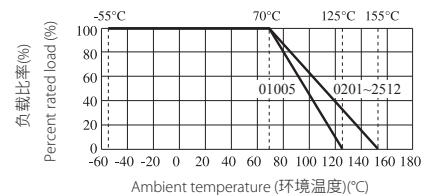

Type 类型	PF0A	PF01	PF02	PF03	PF05	PF06	PF07	PF11	PF10	PF12
Size 尺寸	01005 (0402)	0201 (0603)	0402 (1005)	0603 (1608)	0805 (2012)	1206 (3216)	1210 (3225)	1812 (4532)	2010 (5025)	2512 (6432)
Max. Working Voltage 最大工作电压	15V	25V	50V	75V	150V	200V	200V	200V	200V	200V
Max. Overload Voltage 最大过负荷电压	30V	50V	100V	150V	300V	400V	500V	500V	500V	500V
Dielectric Withstanding Voltage 绝缘耐压	-	-	100V	300V	500V	500V	500V	500V	500V	500V
Operating Temperature 工作温度范围	-55°C~+125°C					-55°C~+155°C				

Type 类型	PF0A	PF01	PF02	PF03	PF05	PF06	PF07	PF11	PF10	PF12	
Power Rating at 70°C 功率	1/32W	1/20W	1/16W	1/10W	1/8W	1/4W	1/2W	3/4W	3/4W	1W	
Dimension 尺寸	L(mm)	0.40±0.02	0.60±0.03	1.00±0.10	1.60±0.10	2.00±0.15	3.10±0.15	3.10±0.10	4.50±0.20	5.00±0.10	6.35±0.10
	W(mm)	0.20±0.02	0.30±0.03	0.50±0.05	0.80±0.10	1.25 ^{+0.15} _{-0.10}	1.55 ^{+0.15} _{-0.10}	2.60±0.20	3.20±0.20	2.50±0.20	3.20±0.20
	H(mm)	0.13±0.02	0.23±0.03	0.35±0.05	0.45±0.10	0.55±0.10	0.55±0.10	0.55±0.10	0.55±0.20	0.55±0.10	0.55±0.10
	A(mm)	0.10±0.05	0.10±0.05	0.20±0.10	0.30±0.20	0.40±0.20	0.45±0.20	0.50±0.25	0.50±0.20	0.60±0.25	0.60±0.25
	B(mm)	0.10±0.03	0.15±0.05	0.25±0.10	0.30±0.20	0.40±0.20	0.45±0.20	0.50±0.20	0.50±0.20	0.50±0.20	0.50±0.20
Resistance Value of Jumper 零欧姆电阻阻值	<50mΩ										
Rated Current of Jumper 零欧姆电阻额定电流	0.5A	0.5A	1A	1A	2A	2A	2A	2A	2A	2A	
Max. Overload Current of Jumper 零欧姆电阻最大过负荷电流	1A	1A	2A	2A	5A	10A	10A	10A	10A	10A	
Resistance Range of 1% (E-96) 1%的阻值范围 (E-96)	10Ω~10MΩ					1Ω~10MΩ					
Resistance Range of 5% (E-24) 5%的阻值范围 (E-24)	1Ω~10MΩ										

Performance Specifications (性能)

Temperature coefficient	温度系数	PF0A: 1Ω≤R≤10Ω: -200~600ppm/°C
		10Ω<R≤100Ω: ±300ppm/°C >100Ω: ±200ppm/°C
Short-time overload	短时间过负荷	PF01: 1Ω≤R≤10Ω: -100~350ppm/°C >10Ω: ±200ppm/°C
		PF02, PF03, PF05, PF06, PF07, PF10, PF11, PF12: 1Ω≤R≤10Ω: ±400ppm/°C 10Ω<R≤100Ω: ±200ppm/°C >100Ω: ±100ppm/°C
Insulation resistance	绝缘电阻	±5%, ±2%: ±(2.0% + 0.1Ω) ±1%, ±0.5%: ±(1.0% + 0.1Ω) PF0A: ±(2.0% + 0.1Ω)
Dielectric withstanding voltage	绝缘耐压	≥ 1,000 MΩ
		No evidence of flashover, mechanical damage, arcing or insulation breakdown 无击穿, 飞弧及可见机械性损伤
Terminal bending	端子弯曲	±(1.0% + 0.05Ω)
Soldering heat	耐焊接热	±(1.0% + 0.05Ω)
Solderability	可焊性	Coverage must be over 95%.
Rapid change of temperature	温度快速变化	±5%, ±2%: ±(1.0% + 0.05Ω) ±1%, ±0.5%: ±(0.5% + 0.05Ω) PF0A: ±(1.0% + 0.05Ω)
		±5%, ±2%: ±(3.0% + 0.1Ω) ±1%, ±0.5%: ±(0.5% + 0.1Ω) PF0A: ±(3.0% + 0.1Ω)
Humidity (Steady State)	恒定湿热	±5%, ±2%: ±(3.0% + 0.1Ω) ±1%, ±0.5%: ±(1% + 0.1Ω) PF0A: ±(3.0% + 0.1Ω)
		±5%, ±2%: ±(3.0% + 0.1Ω) ±1%, ±0.5%: ±(1% + 0.1Ω) PF0A: ±(3.0% + 0.1Ω)
Load life in humidity	湿度寿命	±5%, ±2%: ±(3.0% + 0.1Ω) ±1%, ±0.5%: ±(1% + 0.1Ω) PF0A: ±(3.0% + 0.1Ω)
		±5%, ±2%: ±(3.0% + 0.1Ω) ±1%, ±0.5%: ±(1% + 0.1Ω) PF0A: ±(3.0% + 0.1Ω)
Load life	负载寿命	±5%, ±2%: ±(3.0% + 0.1Ω) ±1%, ±0.5%: ±(1% + 0.1Ω) PF0A: ±(3.0% + 0.1Ω)
		±5%, ±2%: ±(3.0% + 0.1Ω) ±1%, ±0.5%: ±(1% + 0.1Ω) PF0A: ±(3.0% + 0.1Ω)

Ordering Procedure (Example: PF02 1/16W 5% 2.2Ω T/R-10000)

订购方式 (例如: PF02 1/16W 5% 2.2Ω T/R-10000)



Remark: Please refer to page 141 for ordering guide. 注: 下单请详见 P141 页说明。

Feature (特性)

- Thin film NiCr Resistance element
薄膜镍铬阻抗组件
- Very tight tolerance $\pm 0.05\% \sim \pm 1\%$
高精密的公差 $\pm 0.05\% \sim \pm 1\%$
- Extremely low TCR $\pm 5\text{ppm} \sim \pm 50\text{ppm}$
极低的温度系数 $\pm 5\text{ppm} \sim \pm 50\text{ppm}$
- Completed Lead-free 完全无铅产品

Application (应用)

- Automotive 汽车电子
- Automatic equipment 自动化设备
- Communication & telecom 通信终端及设备
- Industrial 工业电子
- Medical Equipment 医疗器材



Figures (型状)



Derating Curve (降功率曲线)



Type 类型	Size 尺寸	L (mm)	W (mm)	H (mm)	A (mm)	B (mm)
TC02	0402 (1005)	1.00±0.10	0.50±0.05	0.35±0.05	0.2±0.1	0.25±0.10
TC03	0603 (1608)	1.60±0.10	0.80±0.10	0.45±0.10	0.3±0.2	0.30±0.20
TC05	0805 (2012)	2.00±0.15	1.25 ^{+0.15} _{-0.10}	0.55±0.10	0.3±0.2	0.40±0.20
TC06	1206 (3216)	3.10±0.15	1.55 ^{+0.15} _{-0.10}	0.55±0.10	0.4±0.2	0.45±0.20
TC07	1210 (3225)	3.10±0.10	2.60±0.20	0.55±0.10	0.4±0.2	0.45±0.20
TC10	2010 (5025)	5.00±0.10	2.50±0.20	0.55±0.10	0.5±0.25	0.50±0.20
TC12	2512 (6432)	6.35±0.10	3.20±0.20	0.55±0.10	0.5±0.25	0.50±0.20

Performance Specifications (性能)

Test Item 试验项目	Test Methods 试验方法	Evaluation Criteria 判定标准
Short-time overload 短时间过负荷	2.5x Rated voltage or Max. Overload Voltage whichever is lower for 5 seconds, then check the resistance. 2.5 倍额定电压或最大过负荷电压 (取其低者), 持续 5 秒钟, 然后测阻值	$\Delta R \leq \pm 0.5\%$
Insulation resistance 绝缘电阻	1. Chip Resistor : the measuring voltage shall be, measured with a direct voltage of (100±15)V or a voltage equal to the dielectric withstanding voltage, and apply for 1 min. 2. TH Resistor: the measuring voltage shall be equal to the dielectric withstanding voltage for resistor with an isolation voltage < 500V or (500±50)V DC, for resistors with an isolation voltage ≥ 500V. 1. 贴片电阻: 绝缘耐压 < 100V, 测试电压取绝缘耐压的电压; 绝缘耐压 ≥ 100V, 测试电压为 100±15VDC, 1 分钟后量测阻值。 2. 插件电阻: 绝缘耐压 < 500V, 测试电压取绝缘耐压的电压; 绝缘耐压 ≥ 500V. 测试电压为 500±50VDC, 1 分钟后量测阻值。	≥ 1,000MΩ
Load life in humidity 湿度寿命	Resistance change after 1000 hours (1.5hours"ON", 0.5hours"OFF") at RCWV or Max.Working Voltage whichever less in a humidity test chamber controlled at 40±2°C and 90~95% RH. 持续时间: 1000h (1.5h"通", 0.5h"断"); 试验温度: 40±2°C; 相对湿度: 90~95% RH; 试验电压: 额定工作电压或最大工作电压 (取其低者)。	$\Delta R \leq \pm 0.5\%$
Load life 负载寿命	Permanent Resistance change after 1000 hours operating at RCWV or Max.Working Voltage whichever less with duty cycle of 1.5 hours "ON", 0.5 hour "OFF" at 70±2°C ambient. 持续时间: 1000h (1.5h"通", 0.5h"断"); 试验温度: 70±2°C; 试验电压: 额定工作电压或最大工作电压 (取其低者)。	$\Delta R \leq \pm 0.2\%$ > 7KΩ $\Delta R \leq \pm 0.5\%$
Humidity (Steady State) 恒定湿热	Temporary resistance change after 240 hours exposure in a humidity test chamber controlled at 40±2°C and 90~95% RH. 在 40±2°C 和 90~95% RH 相对湿度条件下, 存放 240h 后阻值变化率。	$\Delta R \leq \pm 0.3\%$
Terminal bending 端子弯曲	(Applicable for CHIP Resistors 适用晶片电阻) Twist of Test Board: Y/X=3/90mm 60 seconds. 测试板弯曲: Y/X=3/90mm 60 秒。	$\Delta R \leq \pm 0.2\%$
Solderability 可焊性	The area covered with a new, smooth, clean, shiny and continuous surface free from concentrated pinholes. Temperature of solder: 245±3°C; Dwell time in solder: 2~3 seconds. 表面光滑、清洁、均匀、有光泽, 锡炉温度: 245±3°C; 浸入时间: 2~3 秒。	Coverage must be over 95%.
Soldering heat 耐焊接热	(Applicable for TH Resistors 适用插件电阻) Permanent resistor change when leads immersed to a point 2.0~2.5mm from the body in 260±5°C solder 10±1 seconds. 锡炉温度 260±5°C, 浸入深度: 离本体导线根部约 2.0~2.5mm, 处浸入时间 10±1 秒。	$\Delta R \leq \pm 0.2\%$

Electrical Data (电气参数)

Type 类型	Power Rating 功率 at 70°C	Operating Temperature 工作温度范围	Max.Working Voltage 最大工作电压	Max.Overload Voltage 最大过负荷电压	Dielectric With-standing Voltage 绝缘耐压	Resistance Range 阻值范围			TCR 温度系数
						±0.01%	±0.1%	±0.5%	
TC02	1/16W	-55°C~+155°C	25V	50V	100V	/	100Ω~2KΩ	100Ω~2KΩ	±5PPM/°C
						/	50Ω~12KΩ	50Ω~12KΩ	±10PPM/°C
						/	10Ω~332KΩ	10Ω~332KΩ	±25PPM/°C
						/	10Ω~332KΩ	10Ω~332KΩ	±50PPM/°C
TC03	1/10W	-55°C~+155°C	75V	150V	300V	/	100Ω~4KΩ	100Ω~4KΩ	±5PPM/°C
						/	10Ω~50KΩ	10Ω~50KΩ	±10PPM/°C
						4.7Ω~332K	4.7Ω~1MΩ	1Ω~1MΩ	±25PPM/°C
						4.7Ω~332K	4.7Ω~1MΩ	1Ω~1MΩ	±50PPM/°C
TC05	1/8W	-55°C~+155°C	150V	300V	500V	/	100Ω~15KΩ	100Ω~15KΩ	±5PPM/°C
						/	10Ω~100KΩ	10Ω~100KΩ	±10PPM/°C
						4.7Ω~511K	4.7Ω~2MΩ	1Ω~2MΩ	±25PPM/°C
						4.7Ω~511K	4.7Ω~2MΩ	1Ω~2MΩ	±50PPM/°C
TC06	1/4W	-55°C~+155°C	200V	400V	500V	/	100Ω~15KΩ	100Ω~15KΩ	±5PPM/°C
						/	10Ω~200KΩ	10Ω~200KΩ	±10PPM/°C
						4.7Ω~1M	4.7Ω~3MΩ	1Ω~3MΩ	±25PPM/°C
						4.7Ω~1M	4.7Ω~3MΩ	1Ω~3MΩ	±50PPM/°C
TC07	1/3W	-55°C~+155°C	200V	400V	500V	/	100Ω~15KΩ	100Ω~15KΩ	±5PPM/°C
						/	10Ω~200KΩ	10Ω~200KΩ	±10PPM/°C
						4.7Ω~1M	4.7Ω~3MΩ	1Ω~3MΩ	±25PPM/°C
						4.7Ω~1M	4.7Ω~3MΩ	1Ω~3MΩ	±50PPM/°C
TC10	1/3W	-55°C~+155°C	200V	400V	500V	/	100Ω~25KΩ	100Ω~25KΩ	±5PPM/°C
	1/2W					/	50Ω~200KΩ	50Ω~200KΩ	±10PPM/°C
						4.7Ω~1M	4.7Ω~3MΩ	1Ω~3MΩ	±25PPM/°C
						4.7Ω~1M	4.7Ω~3MΩ	1Ω~3MΩ	±50PPM/°C
TC12	3/4W	-55°C~+155°C	200V	400V	500V	/	100Ω~25KΩ	100Ω~25KΩ	±5PPM/°C
						/	50Ω~200KΩ	50Ω~200KΩ	±10PPM/°C
						10Ω~1M	4.7Ω~3MΩ	1Ω~3MΩ	±25PPM/°C
						10Ω~1M	4.7Ω~3MΩ	1Ω~3MΩ	±50PPM/°C

Ordering Procedure (Example:Thin Film TC06 1/3W 0.1% 25PPM 1KΩ T/R-5000)

订购方式(例如: 薄膜TC06 1/3W 0.1% 25PPM 1KΩ T/R-5000)



Remark: Please refer to page 141 for ordering guide. 注: 下单请详见 P141 页说明。

Feature (特性)

- Able to withstand high power 耐高功率
- Ultra Low sensing resistance 超低感应电阻
- Excellent frequency response 优秀的频率响应
- Excellent temperature coefficient characteristics 优秀的温度系数特性

Application (应用)

- Mobile electronic equipment-Cellular phone, NB Tablet PC, GPS,DSC, HDD
移动电话、平板计算机、GPS、DSC、硬盘驱动器
- DC-DC converter, Adapter, Battery pack and charger
直流转换器、适配器、电池和充电器
- Switching power supply 开关电源
- Voltage Regulation module 电压调整模块
- Power management applications 电源管理应用

Figures (型状)



Specification (性能)

Type 类型	Power Rating 功率 70°C	Dimension(尺寸)(mm)					Resistance Range 阻值范围 ±1% & ±5%	T.C.R. 温度系数 ppm/°C
		L	W	H	A	B		
MS05	1/2W	2.00±0.30	1.20±0.30	0.6±0.20	≤1.0	0.65±0.15	5mΩ ~ 9mΩ	±150
						0.57±0.15	12mΩ ~ 13mΩ	
	0.42±0.15	10mΩ, 15mΩ ~ 30mΩ						
MS06	1W	3.10±0.20	1.60±0.30	0.70±0.20	≤1.0	0.42±0.15	10mΩ	±50
						0.86±0.25	7mΩ	±100
						0.76±0.25	5mΩ ~ 6mΩ, 8mΩ 27mΩ ~ 35mΩ	±100
MS10	1.5W	5.00±0.20	2.50±0.25	0.70±0.20	≤1.0	0.46±0.25	10mΩ ~ 25mΩ 37mΩ ~ 51mΩ	±50
						1.45±0.30	6mΩ	±50
						1.25±0.30	4mΩ, 7mΩ	±50
MS12	3W	6.35±0.20	3.20±0.25	0.70±0.20	≤1.0	1.00±0.30	5mΩ, 8mΩ, 10mΩ 11mΩ~25mΩ, 150mΩ	±50
						0.65±0.30	30mΩ~100mΩ	±30
						1.00±0.20	1mΩ	±50
MS12	2W	6.35±0.20	3.20±0.25	0.70±0.20	≤1.0	1.75±0.30	2mΩ	±50
						2.15±0.30	3mΩ	±50
						1.75±0.30	4mΩ, 7mΩ, 8mΩ	±50
MS12	2W	6.35±0.20	3.20±0.25	0.70±0.20	≤1.0	1.35±0.30	5mΩ	±30
						1.15±0.30	6mΩ, 9mΩ~15mΩ	±30
						0.90±0.30	16mΩ~100mΩ	±30
MS12	2W	6.35±0.20	3.20±0.25	0.70±0.20	≤1.0	0.90±0.30	101mΩ~200mΩ	±30

* Other sizes and resistor values can be customized on request. 其他规格和阻值可特别提供

Derating Curve (降功率曲线)



Performance Specifications (性能)

Short-time overload	短时间过负荷	1% & 2%: $\pm(1\%+0.001 \Omega)$ 5%: $\pm(2\%+0.001 \Omega)$
Solderability	可焊性	Coverage must be over 95%.
Low Temperature Storage	低温放置	$\pm(1\%+0.001 \Omega)$
High Temperature Exposure	高温放置	$\pm(1\%+0.001 \Omega)$
Soldering heat	耐焊接热	$\pm(0.5\%+0.005\Omega)$
Load life in humidity	湿度寿命	1% & 2%: $\pm(1\%+0.001 \Omega)$ 5%: $\pm(3\%+0.001 \Omega)$
Load life	负载寿命	1% & 2%: $\pm(1\%+0.001 \Omega)$ 5%: $\pm(3\%+0.001 \Omega)$

Ordering Procedure (Example: MS12 3W 1% 10m Ω T/R-4000)

订购方式 (例如: MS12 3W 1% 10m Ω T/R-4000)



Feature (特性)

- High power rating up to 3 watts 高功率可达 3W
- Low T.C.R until ± 50 PPM 较低的温度系数 ± 50 PPM
- Low resistance values, from 0.5m Ω to 15m Ω 阻值低 0.5m Ω ~15m Ω
- low inductance 低电感
- Tolerance: $\pm 1\%$, $\pm 2\%$, $\pm 5\%$ 精度: $\pm 1\%$, $\pm 2\%$, $\pm 5\%$
- RoHS compliant 符合欧盟 ROHS 标准



Derating Curve (降功率曲线)



Figures (型状)



Type 类型	Power Rating at 70°C 额定功率	T.C.R PPM/°C	Resistance Range(m Ω) 阻值范围	Dimension(mm) 尺寸				Color 颜色	Soldering 焊接
				L	W	T	D		
Standard 标准									
LR06 (1206)	1W	± 100	1~50	3.20 \pm 0.25	1.60 \pm 0.25	0.60 \pm 0.25	0.980 \pm 0.25	Black 黑色	IR reflow 回流焊
LR12 (2512)	1W	± 100	2,5,3	6.35 \pm 0.25	3.18 \pm 0.25	Depends on value 由阻值决定	Depends on value 由阻值决定	Black 黑色	Wave or IR reflow 波峰焊或回流焊
			4,5,10						
			6,6,5,7						
			0.5,0.75,1,1.5,2						
LR12 (2512)	2.0W	± 100	11,12,13,14,15	6.35 \pm 0.25	3.18 \pm 0.25	Depends on value 由阻值决定	Depends on value 由阻值决定	Black 黑色	Wave or IR reflow 波峰焊或回流焊
			0.5						
			0.75~10						
			2,3,5						
			4,5,10						
			6,6,5,7						
LR12 (2512)	2.5W	± 50	0.5,0.75,1,1.5,2	6.35 \pm 0.25	3.18 \pm 0.25	Depends on value 由阻值决定	Depends on value 由阻值决定	Black 黑色	Wave or IR reflow 波峰焊或回流焊
			6.5,7,8,9,10						
			4,4.5,5,6						
			0.5,0.75						
LR12 (2512)	3W	± 50	1,1.5,2,3	6.35 \pm 0.25	3.18 \pm 0.25	Depends on value 由阻值决定	Depends on value 由阻值决定	Black 黑色	Wave or IR reflow 波峰焊或回流焊
			0.5						

Note: LR12 2W special TCR available case by case on basis. Standard Operating Temp -55°C~+170°C
注意: LR12 2W 特殊 TCR 可以特别提供。标准的工作温度 -55°C ~ +170°C

Performance Specifications (性能)

Short-time overload	短时间过负荷	Black coating 黑色涂层: $\pm(0.5\%+0.0005\Omega)$
Resistance to Soldering heat	耐焊接热	Black coating 黑色涂层: $\pm(0.5\%+0.0005\Omega)$
Solderability	可焊性	Coverage must be over 95%.
Thermal Shock	热冲击	Black coating 黑色涂层: $\pm(0.5\%+0.0005\Omega)$
Load life	负载寿命	$\pm(1\%+0.0005\Omega)$

Ordering Procedure (Example:LR12 2W 1% 5mΩ T/R-4000)

订购方式 (例如: LR12 2W 1% 5mΩ T/R-4000)



Feature (特性)

- Electron beam welding structure, stable performance
电子束焊结构, 性能稳定
- RoHS compliant
符合欧盟 ROHS 标准
- Very low resistance
极低电阻值



Application (应用)

- Used in automobiles, fan, lighting
应用于汽车、风机、照明
- Current module, electric welding machine, electric tool industry applications
电流模块, 电焊机, 电动工具领域应用
- There are two side and four end structures
有二端及四端引线结构

Derating Curve (降功率曲线)



Dimension (尺寸) mm

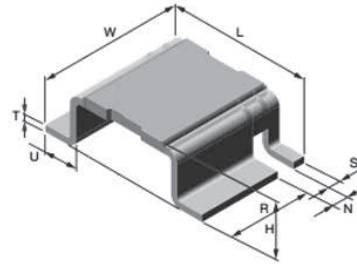

Type 类型	Size 规格	Power Rating 功率 70°C	Dimension(尺寸)(mm)				Resistance Range 阻值范围 ±1%	T.C.R. 温度系数
			L	W	H	A		
RS12	2512	3W	6.30±0.20	3.10±0.30	0.50±0.10	1.20±0.20		
RS21	3921	5W	10.00±0.20	5.10±0.40	0.50±0.10	2.20±0.20	0.2 ~ 1mΩ	±50 ppm/°C
RS31	5931	7W	15.00±0.30	7.60±0.40	0.50±0.10	4.20±0.30		

Type 类型	Size 规格	Power Rating 功率 70°C	Dimension(尺寸)(mm)								Resistance Range 阻值范围 ±1%	T.C.R. 温度系数
			L	W	H	R	S	T	U	N		
RS26	4026	3W	10.1±0.20	6.6+0.5/-0.2	3.0±0.20	5.2±0.20	0.7±0.10	0.4±0.10	2.0±0.10	1.0±0.15	0.5mΩ	±100ppm/°C

*其他规格和阻值可特别提供
* Special size offered.

Performance Specifications (性能)

Short-time Overload	短时间过负荷	1% & 2%: $\pm(1\%+0.0005\ \Omega)$ 5%: $\pm(2\%+0.0005\ \Omega)$
Solderability	可焊性	Coverage must be over 95%.
Rapid change of temperature	温度快速变化	$\pm(1.0\%+0.0005\ \Omega)$
Low Temperature Storage	低温放置	$\pm(1\%+0.0005\ \Omega)$
High Temperature Exposure	高温放置	$\pm(1\%+0.0005\ \Omega)$
Soldering heat	耐焊接热	$\pm(1.0\%+0.0005\ \Omega)$
Load life in humidity	湿度寿命	1% & 2%: $\pm(1\%+0.0005\ \Omega)$ 5%: $\pm(3\%+0.0005\ \Omega)$
Load life	负载寿命	1% & 2%: $\pm(1\%+0.0005\ \Omega)$ 5%: $\pm(3\%+0.0005\ \Omega)$

Ordering Procedure (Example: RS12 3W 1% 0.5m Ω T/R-1000)

订购方式 (例如: RS12 3W 1% 0.5m Ω T/R-1000)



Feature (特性)

- Tolerance 精度为: $\pm 0.5\% \sim \pm 5\%$
- Application automobile industry, comply with the relevant provisions of AEC-Q200. 用于汽车, 符合AEC-Q200相关条款。
- Anti-sulfurized performance 具有抗硫化性能: H_2S 3~5ppm, $50^\circ C \pm 2^\circ C$, 91%~93%RH, 1000H
- Resistance range 阻值范围: $1\Omega \sim 10M\Omega, 0\Omega$
- Operating temperature range 工作温度范围: $-55^\circ C \sim +155^\circ C$
- Stable electrical capability, high reliability 电性能稳定, 可靠性高
- Suit for reflow & wave soldering 适合于回流焊或波峰焊接
- RoHS complaint 符合欧盟ROHS 标准



Application (应用)

- Intelligent home appliances 智能家电产品
- High-end computer 电脑终端
- Medical equipment 医疗设备
- Industrial equipment 工业设备
- Outdoor electronic application 电子门禁

Derating Curve 降功率曲线

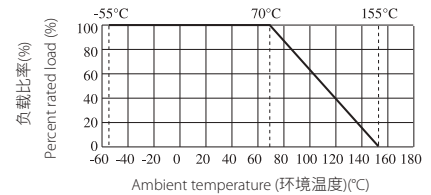

Figures (型状)



Dimension (尺寸) mm

TType	L	W	H	A	B
CQ01 (0201)	0.60±0.03	0.30±0.03	0.23±0.03	0.12±0.05	0.15±0.05
CQ02 (0402)	1.00±0.10	0.50±0.05	0.35±0.05	0.20±0.10	0.25±0.10
CQ03 (0603)	1.60±0.10	0.80±0.10	0.45±0.10	0.30±0.20	0.30±0.20
CQ05 (0805)	2.00±0.15	1.25 ^{+0.15} _{-0.10}	0.55±0.10	0.40±0.20	0.40±0.20
CQ06 (1206)	3.10±0.15	1.55 ^{+0.15} _{-0.10}	0.55±0.10	0.45±0.20	0.45±0.20
CQ07 (1210)	3.10±0.10	2.60±0.20	0.55±0.10	0.50±0.25	0.50±0.20
CQ10 (2010)	5.00±0.10	2.50±0.20	0.55±0.10	0.60±0.25	0.50±0.20
CQ12 (2512)	6.35±0.10	3.20±0.20	0.55±0.10	0.60±0.25	0.50±0.20

Specification (性能)

Type 类型	Power 功率 (70°C)	Tolerance 精度	Resistance Range 阻值范围	Max Working Voltage 最大工作电压	Max Overload Voltage 最大过负荷电压	Dielectric With-standing Voltage 绝缘耐压	Resistance Value of Jumper 零欧姆电阻阻值	Rated Current of Jumper 零欧姆电阻额定电流	Max. Current of Jumper 零欧姆电阻最大电流	Operating Temperature Range 工作温度范围
CQ01(0201)	1/20W	±0.5% ±1% ±2% ±5%	0 Ω 1Ω~10MΩ	25V	50V	/	<50mΩ	0.5A	1A	-55~+155°C
CQ02(0402)	1/16W			50V	100V	100V	<50mΩ	1A	2A	
CQ03(0603)	1/10W			75V	150V	300V	<50mΩ	1A	2A	
CQ05(0805)	1/8W			150V	300V	500V	<50mΩ	2A	5A	
CQ06(1206)	1/4W			200V	400V	500V	<50mΩ	2A	10A	
CQ07(1210)	1/2W			200V	500V	500V	<50mΩ	2A	10A	
CQ10(2010)	3/4W			200V	500V	500V	<50mΩ	2A	10A	
CQ12(2512)	1W			200V	500V	500V	<50mΩ	2A	10A	

Performance Specification (性能)

Test Item 试验项目	Reference standard 参考标准	Test Methods 试验方法	Evaluation Criteria 判定标准
Temperature Coefficient of Resistance 温度系数	MIL-STD-202 Method 304	Measure between: -55°C ~+155°C 测定范围: -55°C ~+155°C	CQ01: $1\Omega \leq R \leq 10\Omega$: -100~+350ppm/°C >10Ω: ±200ppm/°C CQ02-CQ12: 1Ω≤R≤10Ω: ±200ppm/°C >10Ω: ±100ppm/°C
Pre- and Post-Stress Electrical Test (Short time Overload) 短时间过负荷	AEC-Q200 TEST 1 IEC60115 4.13	2.5x Rated voltage or Max. Overload Voltage whichever is lower for 5 seconds, then check the resistance. 2.5 倍额定电压或最大过负荷电压 (取其低者), 持续 5 秒钟, 然后测阻值。	±1%: ±(1.0%+0.05Ω) ±5%: ±(2.0%+0.05Ω)
Biased Humidity 偏置湿度	AEC-Q200 TEST 7 MIL-STD-202 Method 103	1000 hours 85°C/85%RH. Note: Specified conditions:10% of operating power. Measurement at 24±4 hours after test conclusion. 在温度 85 °C, 湿度 85% 的条件下放置 1000 小时。 注意: 指定条件: 工作功率的 10%, 试验结束后 24±4 小时内进行测试。	±1%: ±(1.0%+0.05Ω) ±5%: ±(3.0%+0.05Ω)
Operational Life 工作寿命	AEC-Q200 TEST 8 MIL-STD-202 Method 108	1,000 hours at 125°C, applied de-rated (36%) power of continuous working voltage, 1.5 hours on, 0.5 hour off. 125°C 下 36% 的额定功率, 1.5 小时 ON, 0.5 小时 OFF, 1000H.	±1%: ±(1.0%+0.1Ω) ±5%: ±(3.0%+0.1Ω)
Resistance to Soldering Heat 耐焊接热	AEC-Q200 TEST 15 MIL-STD-202 Method 210	Condition B No pre-heat of samples. Note: Single Wave Solder - Procedure 2 for SMD and Procedure 1 for Leaded with solder within 1.5mm of device body. 条件 B, 样品不进行预热。注意: 单一波峰焊 - 表面贴装元件按程序 2: 引脚产品按程序 1 进行焊接, 浸入器件本体的 1.5mm 的深度	±(1.0%+0.05Ω)
Solderability 可焊性	AEC-Q200 TEST 18 J-STD-002	SMD. Electrical test not required. Magnification 50 X. Conditions: 1. Baking 4 hours@155°C dry heat, dipping @ 245±3°C for 5±0.5 second. 2. Steam aging 8 hours, dipping @ 260±3°C for 30±0.5 second. 表面贴装元件, 不需要电气测试. 放大倍数 50 倍. 测试条件: 1. 155°C 干燥 4H 后, 245°C 5±0.5 秒浸锡. 2. 8H 蒸汽后, 260±3°C 30±0.5 秒浸锡.	Coverage must be over 95%.
Board Flex 弯曲	AEC-Q200 TEST 21 AEC-Q200-005	Bending 3mm(CQ01-CQ05)/2mm(CQ06-CQ12)for 60±5sec 弯曲 3mm(CQ01-CQ05)/2mm(CQ06-CQ12) 保持 60±5 秒	±(1.0%+0.05Ω)
Sulfuration test 硫化测试		H ₂ S 3~5PPM 50°C±2°C 91%~93% RH 1000H	±5%: ±(5.0%+0.05 Ω) ±1%: ±(1.0%+0.05 Ω)

Ordering Procedure (Example: CQ06 1/4W 5% 1.2 Ω T/R-5000)

订购方式 (例如: CQ06 1/4W 5% 1.2 Ω T/R-5000)

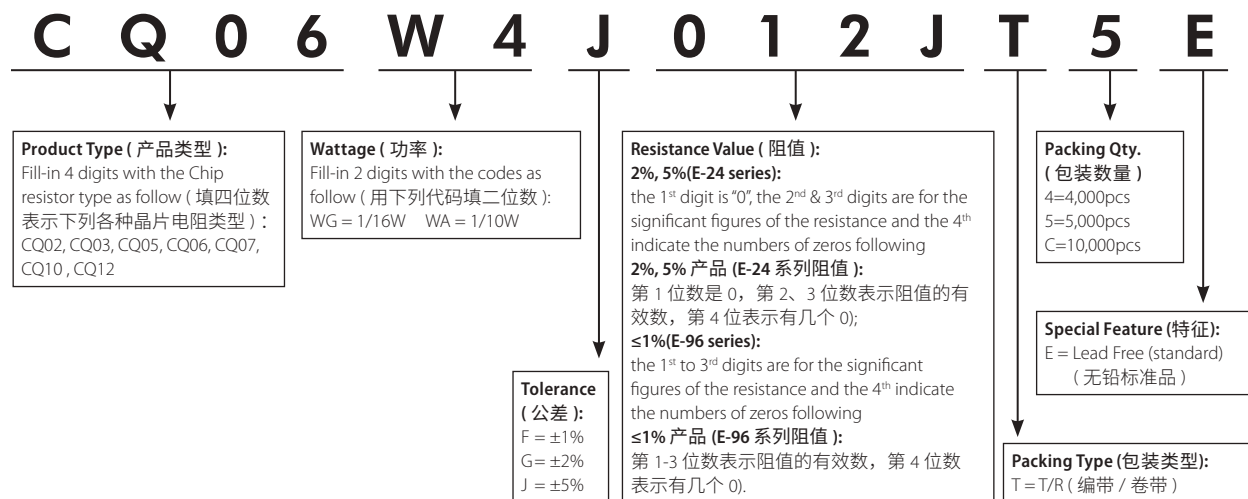

Remark: Please refer to page 141 for ordering guide. 注: 下单请详见 P141 页说明。

Feature (特性)

- Comply with the relevant provision of AEC-Q200
符合AEC-Q200相关条款
- Suitable for reflow & wave soldering. 适合波峰焊与回流焊
- Application car. 适用于汽车

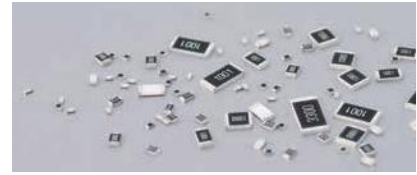

Figures (型状)



Derating Curve 降功率曲线



Specification (性能)

Type 类型	Max working voltage 最大工作电压	Max Overload Voltage 最大过负荷电压	Dielectric Withstanding Voltage 绝缘耐压	Resistance Value of Jumper 零欧姆电阻阻值	Rated Current Of Jumper 零欧姆电阻额定电流	Max. Overload Current of Jumper 零欧姆电阻最大过负荷电流	Operating Temperature 工作温度范围
HQ02	50V	100V	100V	< 50mΩ	1A	2A	-55~+155°C
HQ03	75V	150V	300V		1A	2A	
HQ05	150V	300V	500V		2A	5A	
HQ06	200V	400V	500V		2A	10A	
HQ07	200V	500V	500V		2A	10A	
HQ10	200V	500V	500V		2A	10A	
HQ12	250V	500V	500V		2A	10A	

Type 类型	Size 尺寸	Power 功率 (70°C)	L (mm)	W (mm)	H (mm)	A (mm)	B (mm)	Resistance Range 阻值范围 1%(E96), 5%(E24)
HQ02	0402 (1005)	1/10W	1.00±0.10	0.50±0.05	0.35±0.05	0.20±0.10	0.25±0.10	1Ω~10M
HQ03	0603 (1608)	1/5W	1.60±0.10	0.80±0.10	0.45±0.10	0.30±0.20	0.30±0.20	
HQ05	0805 (2012)	1/3W	2.00±0.15	1.25 ^{+0.15} _{-0.10}	0.55±0.10	0.40±0.20	0.40±0.20	
HQ06	1206 (3216)	1/2W	3.10±0.15	1.55 ^{+0.15} _{-0.10}	0.55±0.10	0.45±0.20	0.45±0.20	
HQ07	1210 (3225)	3/4W	3.10±0.10	2.60±0.20	0.55±0.10	0.50±0.25	0.50±0.20	
HQ10	2010 (5025)	1W	5.00±0.10	2.50±0.20	0.55±0.10	0.60±0.25	0.50±0.20	
HQ12	2512 (6432)	2W	6.35±0.10	3.20±0.20	0.55±0.10	0.60±0.25	0.50±0.20	

*Special offers 特别提供: HQ12 B:1.80±0.25mm

Performance Specification (性能)

Test Item 试验项目	Reference standard 参考标准	Test Methods 试验方法	Evaluation Criteria 判定标准
Temperature Coefficient of Resistance 温度系数	MIL-STD-202 Method 304	Measure between: -55°C ~+155°C 测定范围: -55°C ~+155°C	1Ω≤R≤10Ω:±200ppm/°C 10Ω<R≤10MΩ:±100ppm/°C
Pre- and Post-Stress Electrical Test (Short time Overload) 短时间过负荷	AEC-Q200 TEST 1 IEC60115 4.13	2.5x Rated voltage or Max. Overload Voltage whichever is lower for 5 seconds, then check the resistance. 2.5 倍额定电压或最大过负荷电压 (取其低者), 持续 5 秒钟, 然后测阻值。	±1%: ±(1.0%+0.05Ω) ±5%: ±(2.0%+0.05Ω)
Biased Humidity 偏置湿度	AEC-Q200 TEST 7 MIL-STD-202 Method 103	1000 hours 85°C/85%RH. Note: Specified conditions:10% of operating power. Measurement at 24±4 hours after test conclusion. 在温度 85 °C, 湿度 85% 的条件下放置 1000 小时。 注意: 指定条件: 工作功率的 10%, 试验结束后 24±4 小时内进行测试。	±1%: ±(1.0%+0.05Ω) ±5%: ±(3.0%+0.05Ω)
Operational Life 工作寿命	AEC-Q200 TEST 8 MIL-STD-202 Method 108	1,000 hours at 125°C, applied de-rated (36%) power of continuous working voltage, 1.5 hours on, 0.5 hour off. 125°C 下 36% 的额定功率, 1.5 小时 ON, 0.5 小时 OFF, 1000H.	±1%: ±(1.0%+0.1Ω) ±5%: ±(3.0%+0.1Ω)
Resistance to Soldering Heat 耐焊接热	AEC-Q200 TEST 15 MIL-STD-202 Method 210	Condition B No pre-heat of samples. Note: Single Wave Solder - Procedure 2 for SMD and Procedure 1 for Leaded with solder within 1.5mm of device body. 条件 B, 样品不进行预热。注意: 单一波峰焊 - 表面贴装元件按程序 2: 引脚产品按程序 1 进行焊接, 浸入器件本体的 1.5mm 的深度	±(1.0%+0.05Ω)
Solderability 可焊性	AEC-Q200 TEST 18 J-STD-002	SMD. Electrical test not required. Magnification 50 X. Conditions: 1. Baking 4 hours@155°C dry heat, dipping @ 245±3°C for 5±0.5 second. 2. Steam aging 8 hours, dipping @ 260±3°C for 30±0.5 second. 表面贴装元件, 不需要电气测试. 放大倍数 50 倍. 测试条件: 1.155°C 干燥 4H 后, 245 °C 5±0.5 秒浸锡. 2.8H 蒸汽后, 260±3°C 30±0.5 秒浸锡.	Coverage must be over 95%.
Board Flex 弯曲	AEC-Q200 TEST 21 AEC-Q200-005	Bending 3mm(HQ02-HQ05)/2mm(HQ06-HQ12) for 60±5sec 弯曲 3mm(HQ02-HQ05)/2mm(HQ06-HQ12) 保持 60±5 秒	±(1.0%+0.05Ω)
Sulfuration test 硫化测试		H ₂ S 3~5PPM 50°C±2°C 91%~93% RH 1000H	±5%: ±(5.0%+0.1 Ω) ±1%: ±(1.0%+0.1 Ω)

Ordering Procedure (Example: HQ06 1/4W 5% 1.2 Ω T/R-5000)

订购方式 (例如: HQ06 1/4W 5% 1.2 Ω T/R-5000)



Remark: Please refer to page 141 for ordering guide. 注: 下单请详见 P141 页说明。

Feature (特性)

- Ultra-low Value
超低阻值
- Low Temperature Coefficient
低温度系数
- Suitable for reflow & wave soldering
适合波峰焊及回流焊
- Application: Power supply
应用于电源

Figures (型状)



Derating Curve & Specification (降功率曲线及性能)



Type 类型	Dielectric Withstanding Voltage 绝缘耐压	Operating Temperature 工作温度范围
CS02	100V	-55°C~155°C
CS03	300V	-55°C~155°C
CS05	500V	-55°C~155°C
CS06	500V	-55°C~155°C
CS07	500V	-55°C~155°C
CS10	500V	-55°C~155°C
CS11	500V	-55°C~155°C
CS12	500V	-55°C~155°C

Type 类型	Size 尺寸	Power Rating 功率 70°C	L(mm)	W(mm)	H(mm)	A(mm)	B(mm)	Resistance Range 阻值范围 1% & 5%	T.C.R. 温度系数
CS02	0402 (1005)	1/8W	1.00±0.10	0.50±0.05	0.35±0.05	0.20±0.10	0.25±0.10	50mΩ~1Ω	50mΩ≤R<100mΩ: ±700 ppm/°C
									100mΩ≤R≤1Ω: ±200 ppm/°C
CS03	0603 (1608)	1/5W	1.60±0.10	0.80±0.10	0.45±0.10	0.30±0.20	0.30±0.20	10mΩ~1Ω	10mΩ≤R<15mΩ: ±1500ppm/°C
									15mΩ≤R<20mΩ: ±1000ppm/°C
									20mΩ≤R<30mΩ: ±800 ppm/°C
									30mΩ≤R<33mΩ: ±600 ppm/°C
									33mΩ≤R≤50mΩ: ±400 ppm/°C
50mΩ<R≤0.1Ω: ±300 ppm/°C									
0.1Ω<R≤1Ω: ±200 ppm/°C									
CS05	0805 (2012)	1/4W	2.00±0.15	1.25 ^{+0.15} _{-0.10}	0.55±0.10	0.40±0.20	0.40±0.20	10mΩ~1Ω	10mΩ≤R≤15mΩ: ±800 ppm/°C
									15mΩ<R≤25mΩ: ±600 ppm/°C
									25mΩ<R≤50mΩ: ±400 ppm/°C
									50mΩ<R≤0.2Ω: ±200 ppm/°C
0.2Ω<R≤1Ω: ±100 ppm/°C									
CS06	1206 (3216)	1/3W	3.10±0.15	1.55 ^{+0.15} _{-0.10}	0.55±0.10	0.45±0.20	0.45±0.20	10mΩ~1Ω	10mΩ≤R<15mΩ: ±700ppm/°C
									15mΩ≤R≤30mΩ: ±400ppm/°C
									30mΩ<R≤50mΩ: ±300ppm/°C
									50mΩ<R≤0.1Ω: ±200ppm/°C
0.1Ω<R≤1Ω: ±150ppm/°C									
CS07	1210 (3225)	1/2W	3.10±0.10	2.60±0.20	0.55±0.10	0.50±0.25	0.50±0.20	10mΩ~1Ω	10mΩ≤R<15mΩ: ±500ppm/°C
									15mΩ≤R<20mΩ: ±400ppm/°C
									20mΩ≤R≤50mΩ: ±300ppm/°C
									50mΩ<R≤1Ω: ±100ppm/°C
CS10	2010 (5025)	3/4W	5.00±0.10	2.50±0.20	0.55±0.10	0.60±0.25	0.50±0.20	10mΩ~1Ω	10mΩ≤R<15mΩ: ±600ppm/°C
									15mΩ≤R<20mΩ: ±500ppm/°C
									20mΩ≤R≤30mΩ: ±300ppm/°C
									30mΩ<R≤50mΩ: ±200ppm/°C
									50mΩ<R≤0.1Ω: ±150ppm/°C
0.1Ω<R≤1Ω: ±100ppm/°C									
CS11	1812 (4532)	3/4W	4.50±0.20	3.20±0.20	0.55±0.20	0.50±0.20	0.80±0.30	10mΩ~1Ω	10mΩ≤R<20mΩ: ±500ppm/°C
									20mΩ≤R<50mΩ: ±400ppm/°C
									50mΩ≤R≤0.1Ω: ±200ppm/°C
									0.1Ω<R≤1Ω: ±100ppm/°C
CS12	2512 (6432)	1W	6.35±0.10	3.20±0.20	0.55±0.10	0.60±0.25	0.80±0.30	10mΩ~1Ω	10mΩ≤R<15mΩ: ±600ppm/°C
									15mΩ≤R<20mΩ: ±400ppm/°C
									20mΩ≤R≤30mΩ: ±300ppm/°C
									30mΩ<R≤50mΩ: ±200ppm/°C
									50mΩ<R≤0.1Ω: ±150ppm/°C
0.1Ω<R≤1Ω: ±100ppm/°C									

Performance Specifications (性能)

Test Item 试验项目	Reference standard 参考标准	Test Methods 试验方法	Evaluation Criteria 判定标准
Pre- and Post-Stress Electrical Test (Short time Overload) 短时间过负荷	AEC-Q200 TEST 1 IEC60115 4.13	2.5x Rated voltage or Max. Overload Voltage whichever is lower for 5 seconds, then check the resistance. 2.5 倍额定电压或最大过负荷电压 (取其低者), 持续 5 秒钟, 然后测阻值。	±1%: ±(1.0%+0.05Ω) ±5%: ±(2.0%+0.05Ω)
Biased Humidity 偏置湿度	AEC-Q200 TEST 7 MIL-STD-202 Method 103	1000 hours 85°C/85%RH. Note: Specified conditions:10% of operating power. Measurement at 24±4 hours after test conclusion. 在温度 85 °C, 湿度 85% 的条件下放置 1000 小时。 注意: 指定条件: 工作功率的 10%, 试验结束后 24±4 小时内进行测试。	±1%: ±(1.0%+0.05Ω) ±5%: ±(3.0%+0.05Ω)
Operational Life 工作寿命	AEC-Q200 TEST 8 MIL-STD-202 Method 108	1,000 hours at 125°C, applied de-rated (36%) power of continuous working voltage, 1.5 hours on, 0.5 hour off. 125°C 下 36% 的额定功率, 1.5 小时 ON, 0.5 小时 OFF, 1000H.	±1%: ±(1.0%+0.1Ω) ±5%: ±(3.0%+0.1Ω)
Resistance to Soldering Heat 耐焊接热	AEC-Q200 TEST 15 MIL-STD-202 Method 210	Condition B No pre-heat of samples. Note: Single Wave Solder - Procedure 2 for SMD and Procedure 1 for Leaded with solder within 1.5mm of device body. 条件 B, 样品不进行预热。注意: 单一波峰焊 - 表面贴装元件按程序 2: 引脚产品按程序 1 进行焊接, 浸入器件本体的 1.5mm 的深度	±(1.0%+0.05Ω)
Solderability 可焊性	AEC-Q200 TEST 18 J-STD-002	SMD. Electrical test not required. Magnification 50 X. Conditions: 1. Baking 4 hours@155°C dry heat, dipping @ 245±3°C for 5±0.5 second. 2. Steam aging 8 hours, dipping @ 260±3°C for 30±0.5 second. 表面贴装元件, 不需要电气测试. 放大倍数 50 倍. 测试条件: 1. 155°C 干燥 4H 后, 245°C 5±0.5 秒浸锡。 2. 8H 蒸汽后, 260±3°C 30±0.5 秒浸锡。	Coverage must be over 95%.
Board Flex 弯曲	AEC-Q200 TEST 21 AEC-Q200-005	Bending 3mm(CS02-CS05)/2mm(CS06-CS12) for 60±5sec 弯曲 3mm(CS02-CS05)/2mm(CS06-CS12) 保持 60±5 秒	±(1.0%+0.05Ω)

* CS07 size in 0.75W 0.1~1Ω 100PPM/°C could be provided specially (* CS07 0.75W 0.1~1Ω 100PPM/°C 可特别提供)

Ordering Procedure (Example: CS12 1W 5% 22mΩ T/R-4000)

订购方式 (例如: CS12 1W 5% 22mΩ T/R-4000)



Remark: Please refer to page 141 for ordering guide. 注: 下单请详见 P141 页说明。

Feature (特性)

- Excellent Anti-Sulfurized 卓越的抗硫化
- AEC-Q200 qualified 符合 AEC-Q200 相关条款
- Suitable for reflow & wave soldering 适合波峰焊和回流焊
- RoHS compliant 符合欧盟 ROHS 标准



Figures (型状)



Derating Curve (降功率曲线)



Specification (性能)

Type 类型	Size 尺寸	Max Working Voltage 最大工作电压	Max Overload Voltage 最大过负荷电压	Dielectric Withstanding Voltage 绝缘耐压	Resistance Value of Jumper 零欧姆电阻阻值	Rated Current of Jumper 零欧姆电阻额定电流	Max. Overload Current of Jumper 零欧姆电阻最大过负荷电流	Operating Temperature 工作温度范围
NQ01	0201 (0603)	25V	50V	/	<50mΩ	0.5A	1A	-55~+155°C
NQ02	0402 (1005)	50V	100V	100V	<50mΩ	1A	2A	
NQ03	0603 (1608)	75V	150V	300V	<50mΩ	1A	2A	
NQ05	0805 (2012)	150V	300V	500V	<50mΩ	2A	5A	
NQ06	1206 (3216)	200V	400V	500V	<50mΩ	2A	10A	
NQ07	1210 (3225)	200V	500V	500V	<50mΩ	2A	10A	
NQ10	2010 (5025)	200V	500V	500V	<50mΩ	2A	10A	
NQ12	2512 (6432)	200V	500V	500V	<50mΩ	2A	10A	

Type 类型	Size 尺寸	Power 功率 (70°C)	L (mm)	W (mm)	H (mm)	A (mm)	B (mm)	Resistance Range 阻值范围 1%(E96), 5%(E24)
NQ01	0201 (0603)	1/20W	0.60±0.03	0.30±0.03	0.23±0.03	0.12±0.05	0.15±0.05	1Ω~10M Ω
NQ02	0402 (1005)	1/16W	1.00±0.10	0.50±0.05	0.35±0.05	0.20±0.10	0.25±0.10	
NQ03	0603 (1608)	1/10W	1.60±0.10	0.80±0.10	0.45±0.10	0.30±0.20	0.30±0.20	
NQ05	0805 (2012)	1/8W	2.00±0.15	1.25 ^{+0.15} _{-0.10}	0.55±0.10	0.40±0.20	0.40±0.20	
NQ06	1206 (3216)	1/4W	3.10±0.15	1.55 ^{+0.15} _{-0.10}	0.55±0.10	0.45±0.20	0.45±0.20	
NQ07	1210 (3225)	1/2W	3.10±0.10	2.60±0.20	0.55±0.10	0.50±0.25	0.50±0.20	
NQ10	2010 (5025)	3/4W	5.00±0.10	2.50±0.20	0.55±0.10	0.60±0.25	0.50±0.20	
NQ12	2512 (6432)	1W	6.35±0.10	3.20±0.20	0.55±0.10	0.60±0.25	0.50±0.20	

Performance Specification (性能)

Test Item 试验项目	Reference standard 参考标准	Test Methods 试验方法	Evaluation Criteria 判定标准
Temperature Coefficient of Resistance 温度系数	MIL-STD-202 Method 304	Measure between: -55°C ~ +155°C 测定范围: -55°C ~ +155°C	NQ01: $1\Omega \leq R \leq 10\Omega$: -100 ~ +350ppm/°C >10Ω: ± 200 ppm/°C NQ02-NQ12: $1\Omega \leq R \leq 10\Omega$: ± 200 ppm/°C >10Ω: ± 100 ppm/°C
Pre- and Post-Stress Electrical Test (Short time Overload) 短时间过负荷	AEC-Q200 TEST 1 IEC60115 4.13	2.5x Rated voltage or Max. Overload Voltage whichever is lower for 5 seconds, then check the resistance. 2.5 倍额定电压或最大过负荷电压 (取其低者), 持续 5 秒钟, 然后测阻值。	$\pm 1\%$: $\pm(1.0\%+0.05\Omega)$ $\pm 5\%$: $\pm(2.0\%+0.05\Omega)$
Biased Humidity 偏置湿度	AEC-Q200 TEST 7 MIL-STD-202 Method 103	1000 hours 85°C/85%RH. Note: Specified conditions: 10% of operating power. Measurement at 24±4 hours after test conclusion. 在温度 85 °C, 湿度 85% 的条件下放置 1000 小时。 注意: 指定条件: 工作功率的 10%, 试验结束后 24±4 小时内进行测试。	$\pm 1\%$: $\pm(1.0\%+0.05\Omega)$ $\pm 5\%$: $\pm(3.0\%+0.05\Omega)$
Operational Life 工作寿命	AEC-Q200 TEST 8 MIL-STD-202 Method 108	1,000 hours at 125°C, applied de-rated (36%) power of continuous working voltage, 1.5 hours on, 0.5 hour off. 125°C 下 36% 的额定功率, 1.5 小时 ON, 0.5 小时 OFF, 1000H.	$\pm 1\%$: $\pm(1.0\%+0.1\Omega)$ $\pm 5\%$: $\pm(3.0\%+0.1\Omega)$
Resistance to Soldering Heat 耐焊接热	AEC-Q200 TEST 15 MIL-STD-202 Method 210	Condition B No pre-heat of samples. Note: Single Wave Solder - Procedure 2 for SMD and Procedure 1 for Leaded with solder within 1.5mm of device body. 条件 B, 样品不进行预热。注意: 单一波峰焊 - 表面贴装元件按程序 2: 引脚产品按程序 1 进行焊接, 浸入器件本体的 1.5mm 的深度	$\pm(1.0\%+0.05\Omega)$
Solderability 可焊性	AEC-Q200 TEST 18 J-STD-002	SMD. Electrical test not required. Magnification 50 X. Conditions: 1. Baking 4 hours@155°C dry heat, dipping @ 245±3°C for 5±0.5 second. 2. Steam aging 8 hours, dipping @ 260±3°C for 30±0.5 second. 表面贴装元件, 不需要电气测试. 放大倍数 50 倍. 测试条件: 1. 155°C 干燥 4H 后, 245°C 5±0.5 秒浸锡. 2. 8H 蒸汽后, 260±3°C 30±0.5 秒浸锡.	Coverage must be over 95%. 覆盖率 ≥ 95%
Board Flex 弯曲	AEC-Q200 TEST 21 AEC-Q200-005	Bending 3mm(NQ01-NQ05)/2mm(NQ06-NQ12) for 60±5sec 弯曲 3mm(NQ01-NQ05)/2mm(NQ06-NQ12) 保持 60±5 秒	$\pm(1.0\%+0.05\Omega)$
Sulfuration test 硫化测试		Soaked in industrial oil with sulfur substance 3.5% contained 105°C ±3°C 500h 工业用油含硫磺成份 3.5%, 105°C ±3°C, 500H	$\Delta R \leq \pm(5\%+0.05\Omega)$

Ordering Procedure (Example: NQ06 1/4W 5% 1.2 Ω T/R-5000)

订购方式 (例如: NQ06 1/4W 5% 1.2 Ω T/R-5000)



Remark: Please refer to page 141 for ordering guide. 注: 下单请详见 P141 页说明。

Feature (特性)

- Superior Anti-Sulfurized 优越的抗硫化
- Superior Anti-Surge Voltage performance 优越的抗浪涌电压特性
- Suitable for reflow & wave soldering 适合波峰焊与回流焊
- Application automobile industry, comply with the relevant provisions of AEC-Q200, 100% power rating under +125°C 用于汽车, 符合 AEC-Q200 相关条款, +125° 温度下 100% 功率使用



Figures (型状)



Derating Curve (降功率曲线)

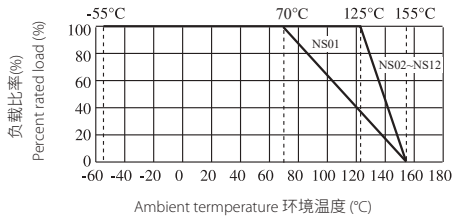

Curve of Pulse Duration (脉冲曲线)



Specification (性能)

Type 类型	Size 尺寸	Max working voltage 最大工作电压	Max Overload Voltage 最大过负荷电压	Dielectric Withstanding Voltage 绝缘耐压	Resistance Value of Jumper 零欧姆电阻阻值	Rated Current of Jumper 零欧姆电阻额定电流	Max. Overload Current of Jumper 零欧姆电阻最大过负荷电流	Operating Temperature 工作温度范围
NS01	0201 (0603)	25V	50V	/	< 50mΩ	0.5A	1A	-55~+155°C
NS02	0402 (1005)	50V	100V	100V	< 50mΩ	1A	2A	
NS03	0603 (1608)	75V	150V	300V	< 50mΩ	1A	2A	
NS05	0805 (2012)	150V	300V	500V	< 50mΩ	2A	5A	
NS06	1206 (3216)	200V	400V	500V	< 50mΩ	2A	10A	
NS07	1210 (3225)	200V	500V	500V	< 50mΩ	2A	10A	
NS10	2010 (5025)	200V	500V	500V	< 50mΩ	2A	10A	
NS12	2512 (6432)	200V	500V	500V	< 50mΩ	2A	10A	

Type 类型	Power 功率	L (mm)	W (mm)	H (mm)	A (mm)	B (mm)	Resistance Range 阻值范围 1%(E96), 5%(E24)
NS01	1/20W	0.60±0.03	0.30±0.03	0.23±0.03	0.12±0.05	0.15±0.05	1Ω~10M Ω
NS02	1/16W	1.00±0.10	0.50±0.05	0.35±0.05	0.20±0.10	0.25±0.10	
NS03	1/10W	1.60±0.10	0.80±0.10	0.45±0.10	0.30±0.20	0.30±0.20	
NS05	1/8W	2.00±0.15	1.25 ^{+0.15} _{-0.10}	0.55±0.10	0.40±0.20	0.40±0.20	
NS06	1/4W	3.10±0.15	1.55 ^{+0.15} _{-0.10}	0.55±0.10	0.45±0.20	0.45±0.20	
NS07	1/3W	3.10±0.10	2.60±0.20	0.55±0.10	0.50±0.25	0.50±0.20	
NS10	3/4W	5.00±0.10	2.50±0.20	0.55±0.10	0.60±0.25	0.50±0.20	
NS12	1W	6.35±0.10	3.20±0.20	0.55±0.10	0.60±0.25	0.50±0.20	

* Special offered 特别提供 : NS12 B:1.80±0.25mm

Performance Specification (性能)

Test Item 试验项目	Reference standard 参考标准	Test Methods 试验方法	Evaluation Criteria 判定标准
Temperature Coefficient of Resistance 温度系数	MIL-STD-202 Method 304	Measure between: -55°C ~+155°C 测定范围: -55°C ~+155°C	NS01: 1Ω≤R≤10Ω: -100~+350ppm/°C >10Ω: ±200ppm/°C NS02-NS12: 1Ω≤R≤10Ω: ±200ppm/°C >10Ω: ±100ppm/°C
Pre- and Post-Stress Electrical Test (Short time Overload) 短时间过负荷	AEC-Q200 TEST 1 IEC60115 4.13	2.5x Rated voltage or Max. Overload Voltage whichever is lower for 5 seconds, then check the resistance. 2.5 倍额定电压或最大过负荷电压 (取其低者), 持续 5 秒钟, 然后测阻值。	±1%: ±(1.0%+0.05Ω) ±5%: ±(2.0%+0.05Ω)
Biased Humidity 偏置湿度	AEC-Q200 TEST 7 MIL-STD-202 Method 103	1000 hours 85°C/85%RH. Note: Specified conditions:10% of operating power. Measurement at 24±4 hours after test conclusion. 在温度 85 °C, 湿度 85% 的条件下放置 1000 小时。 注意: 指定条件: 工作功率的 10%, 试验结束后 24±4 小时内进行测试。	±1%: ±(1.0%+0.05Ω) ±5%: ±(3.0%+0.05Ω)
Operational Life 工作寿命	AEC-Q200 TEST 8 MIL-STD-202 Method 108	Condition D Steady State TA=125°C at rated power.Measurement at 24±4 hours after test conclusion. 条件 D, 稳定状态 TA=125°C, 额定功率。实验结束后 24±4 小时内进行测试。	±1%: ±(1.0%+0.1Ω) ±5%: ±(3.0%+0.1Ω)
Resistance to Soldering Heat 耐焊接热	AEC-Q200 TEST 15 MIL-STD-202 Method 210	Condition B No pre-heat of samples. Note: Single Wave Solder - Procedure 2 for SMD and Procedure 1 for Leaded with solder within 1.5mm of device body. 条件 B, 样品不进行预热。注意: 单一波峰焊 - 表面贴装元件按程序 2: 引脚产品按程序 1 进行焊接, 浸入器件本体的 1.5mm 的深度	±(1.0%+0.05Ω)
Solderability 可焊性	AEC-Q200 TEST 18 J-STD-002	SMD. Electrical test not required. Magnification 50 X. Conditions: 1. Baking 4 hours@155°C dry heat, dipping @ 245±3°C for 5±0.5 second. 2. Steam aging 8 hours, dipping @ 260±3°C for 30±0.5 second. 表面贴装元件, 不需要电气测试. 放大倍数 50 倍。 测试条件: 1.155°C 干燥 4H 后, 245°C 5±0.5 秒浸锡。 2.8H 蒸汽后, 260±3°C 30±0.5 秒浸锡。	Coverage must be over 95%.
Board Flex 弯曲	AEC-Q200 TEST 21 AEC-Q200-005	Bending 3mm(NS01-NS05)/2mm(NS06-NS12)for 60±5sec 弯曲 3mm(NS01-NS05)/2mm(NS06-NS12) 保持 60±5 秒	±(1.0%+0.05Ω)
Sulfuration test 硫化测试		Soaked in industrial oil with sulfur substance 3.5% contained 105°C ±3°C 500h 工业用油含硫磺成份 3.5%, 105°C±3°C, 500H	ΔR≤±(5%+0.05Ω)

Ordering Procedure (Example: NS06 1/4W 5% 1.2 Ω T/R-5000)

订购方式 (例如: NS06 1/4W 5% 1.2 Ω T/R-5000)



Remark: Please refer to page 141 for ordering guide. 注: 下单请详见 P141 页说明。

Feature (特性)

- Anti-Sulfidation 抗硫化
- Suitable for reflow & wave soldering 适合波峰焊与回流焊
- Application car, power 适用于汽车、电源等



Derating Curve (降功率曲线)



Dimension (mm) & Conformation [尺寸(mm)与结构]

Type 类型	2S02	4S02	4S03
Size 尺寸	0402x2	0402x4	0603x4
Dimension 规格 (mm)			
Equivalent Circuit Diagram 等效电路图	<p>R1-R2</p>	<p>R1-R2-R3-R4</p>	<p>R1-R2-R3-R4</p>

Characteristics (特性)

Type 类型	Power Rating 功率	Max. Working Voltage 最大工作电压	Max. Overload Voltage 最大过负荷电压	Resistance Range 阻值范围	Dielectric Withstanding Voltage 绝缘耐压	Tolerance 公差	Operating Temperature 工作温度范围	Resistance Value of Jumper 零欧姆电阻阻值	Rated Current of Jumper 零欧姆电阻额定电流	T.C.R 温度系数 (PPM/°C)
2S02				10Ω~1MΩ	100					±200
4S02	1/16W	50V	100V	10Ω~1MΩ	100	±1%, ±5%	-55°C~+155°C	<50mΩ	1A	±200
4S03				1Ω~1MΩ	300					≥10Ω:±200 <10Ω:±400

Performance Specification (性能)

Test Item 试验项目	Reference standard 参考标准	Test Methods 试验方法	Evaluation Criteria 判定标准
Temperature Coefficient of Resistance 温度系数	MIL-STD-202 Method 304	Measure between -55°C ~+155°C 测定范围: -55°C ~+155°C	$1\Omega \leq R \leq 10\Omega: \pm 200\text{ppm}/^\circ\text{C}$ $10\Omega < R \leq 10\text{M}\Omega: \pm 100\text{ppm}/^\circ\text{C}$
Pre- and Post-Stress Electrical Test (Short time Overload) 短時間過負荷	AEC-Q200 TEST 1 IEC60115 4.13	2.5x Rated voltage or Max. Overload Voltage whichever is lower for 5 seconds, then check the resistance. 2.5 倍额定电压或最大过负荷电压 (取其低者), 持续 5 秒钟, 然后测阻值。	$\pm 1\%: \pm (1.0\%+0.05\Omega)$ $\pm 5\%: \pm (2.0\%+0.05\Omega)$
Biased Humidity 偏置湿度	AEC-Q200 TEST 7 MIL-STD-202 Method 103	1000 hours 85°C/85%RH. Note: Specified conditions:10% of operating power.Measurement at 24±4 hours after test conclusion. 在温度 85°C, 湿度 85% 的条件下放置 1000 小时。注意: 指定条件: 工作功率的 10%, 试验结束后 24±4 小时内进行测试。	$\pm 1\%: \pm (1.0\%+0.05\Omega)$ $\pm 5\%: \pm (3.0\%+0.05\Omega)$
Operational Life 工作寿命	AEC-Q200 TEST 8 MIL-STD-202 Method 108	Condition D Steady State TA=125°C at rated power.Measurement at 24±4 hours after test conclusion. 条件 D, 稳定状态 TA=125°C, 额定功率。实验结束后 24±4 小时内进行测试。	$\pm 1\%: \pm (1.0\%+0.1\Omega)$ $\pm 5\%: \pm (3.0\%+0.1\Omega)$
Resistance to Soldering Heat 耐焊接热	AEC-Q200 TEST 15 MIL-STD-202 Method 210	Condition B No pre-heat of samples. Note: Single Wave Solder - Procedure 2 for SMD and Procedure 1 for Leaded with solder within 1.5mm of device body. 条件 B, 样品不进行预热。注意: 单一波峰焊 - 表面贴装元件按程序 2: 引脚产品按程序 1 进行焊接, 浸入器件本体的 1.5mm 的深度	$\pm (1.0\%+0.05\Omega)$
Solderability 可焊性	AEC-Q200 TEST 18 J-STD-002	For both Leaded & SMD. Electrical test not required.Magnification 50 X. Conditions:Leaded: Method A @ 235°C, category 3.SMD: a) Method B, 4 hrs @ 155°C dry heat @ 235°C b) Method B @ 215°C category 3. c) Method D category 3 @ 260°C. 用于引脚和表面贴装元件, 不需要电气测试. 放大倍数 50 倍。 测试条件: 引脚产品: 方法 A@235°C, 类别 3 表面贴装元件: a) 方法 B,4 小时 @155°C干热 @235°C . b) 方法 B@215°C类别 3. c) 方法 D 类别 3@260°C .	Coverage must be over 95%.
Board Flex 弯曲	AEC-Q200 TEST 21 AEC-Q200-005	60 sec minimum holding time. 至少 2mm, 60 秒的支撑时间	$\pm (1.0\%+0.05\Omega)$
Sulfuration test 硫化测试		Soaked in industrial oil with sulfur substance 3.5% contained 105°C ±3°C 500h 工业用油含硫磺成份 3.5%, 105°C±3, 500H	$\Delta R \leq \pm(5\%+0.05\Omega)$

Ordering Procedure (Example: 2S02 1/16W ±5%1.2K T/R-10000)

订购方式 (例如: 2S02 1/16W ±5%1.2K T/R-10000)



Remark: Please refer to page 141 for ordering guide. 注: 下单请详见 P141 页说明。

Feature (特性)

- High density, more than 1 resistors in one small case 高度密集, 多个电阻在一个表贴封装中
- Improvement of placement efficiency 装配效率高
- Tape/Reel packaging is suitable for automatic placement machine 编带卷装适合自动化机器
- Superior solderability 优越焊锡性
- Application: Master board, CD & DVD Rom, Hard Disk, RAM
应用于 CD、DVD、硬盘、内存、主板等



Equivalent Circuit Diagram (等效电路图)



Derating Curve (降功率曲线)



Dimensions in mm (外观尺寸)

Convex Terminal type 凸式电极			Concave Terminal 凹式电极		Flat Terminal 平式电极	
2D02/2D03	4D02/4D03/4DP3	16P8	2C02	4C02/4C03	2F01	4F01

*The 16P8 series of Anti-sulfuration products are available in particular.
*16P8 系列抗硫化产品可特别提供

Type 类型	Dimensions 尺寸 (mm)							
	L	W	T	A1	A2	B	P	G
2D02 0402*2	1.00±0.10	1.00±0.10	0.35±0.10	0.33±0.10	/	0.15±0.05	0.65±0.05	0.25±0.10
4D02 0402*4	2.00±0.10	1.00±0.10	0.45±0.10	0.40±0.05	0.30±0.05	0.20±0.15	0.50±0.05	0.30±0.15
2D03 0603*2	1.60±0.15	1.60±0.15	0.50±0.10	0.60±0.15	/	0.30±0.10	0.80±0.05	0.25±0.10
4D03/4DP3 0603*4	3.20±0.20	1.60±0.20	0.50±0.10	0.65±0.15	0.50±0.15	0.30±0.15	0.80±0.10	0.30±0.15
16P8	4.00±0.20	1.60±0.15	0.45±0.10	0.45±0.05	0.30±0.05	0.30±0.15	0.50±0.05	0.40±0.15
2C02 0402*2	1.00±0.10	1.00±0.10	0.35±0.10	/	/	0.15±0.10	/	0.30±0.10
4C02 0402*4	2.00±0.10	1.00±0.10	0.45±0.10	/	/	0.15±0.10	/	0.30±0.10
4C03 0603*4	3.20±0.20	1.60±0.20	0.60±0.10	/	/	0.30±0.20	/	0.40±0.10
2F01 0201*2	0.80±0.10	0.60±0.10	0.35±0.10	0.30±0.10	/	0.15±0.10	0.50±0.05	0.15±0.10
4F01 0201*4	1.40±0.10	0.60±0.10	0.35±0.10	0.20±0.10	/	0.15±0.10	0.40±0.05	0.15±0.10

Ratings (规格)

Type 类型	Rated power (功率) 70°C	Max Working Voltage 最大工作 电压	Max Overload Voltage 最大过负荷 电压	Dielectric Withstanding Voltage 绝缘耐压	Resistance Range 阻值范围 ±5%, ±1%	Temperature Coefficient 温度系数 PPM/°C	Operating Temperature 工作温度范围	Resistance Value of Jumper 零欧姆电阻 阻值	Rated Current of Jumper 零欧姆电阻额 定电流
2D02	1/16W	50V	100V	100V	10Ω~1MΩ	±200			
4D02	1/16W	50V	100V	100V	10Ω~1MΩ	±200			
2D03	1/16W	50V	100V	100V	10Ω~1MΩ	±200			
4D03	1/16W	50V	100V	300V	1Ω~1MΩ	≥10Ω:±200 <10Ω:±400			
4DP3	1/10W	50V	100V	300V	1Ω~1MΩ	≥10Ω:±200 <10Ω:±400	-55°C~+155°C	<50mΩ	1A
16P8	1/16W	50V	100V	300V	1Ω~1MΩ	≥10Ω:±200 <10Ω:±400			
2C02	1/16W	50V	100V	100V	10Ω~1MΩ	±200			
4C02	1/16W	50V	100V	100V	10Ω~1MΩ	±200			
4C03	1/10W	50V	100V	300V	1Ω~1MΩ	≥10Ω:±200 <10Ω:±400			
2F01	1/20W	12.5V	25V	/	10Ω~1MΩ	±200	-55°C~+125°C	<50mΩ	1A
4F01	1/20W	12.5V	25V	/	10Ω~1MΩ	±200			

Performance Specification (性能)

Short-time overload	短时间过负荷	±(2.0%±0.1Ω) 2F01: 1%: ±1%+0.05Ω, 5%: ±2%+0.05Ω
Insulation Resistance	绝缘电阻	≥1000MΩ
Dielectric withstanding voltage	绝缘耐压	No evidence of flashover mechanical damage, arcing or insulation break down. 无击穿, 飞弧及可见机械性损伤
Terminal bending	端子弯曲	±(1.0%±0.05Ω)
Soldering heat	耐焊接热	ΔR/R ≤ ±(1.0%+0.05Ω)
Solderability	可焊性	Coverage must be over 95%.
Rapid change of temperature	温度快速变化	ΔR/R ≤ ±(1.0%+0.05Ω) 2F01: 1%: ±0.5%+0.05Ω, 5%: ±1%+0.05Ω
Load life in humidity	湿度寿命	±(3.0%±0.1Ω) 2F01: 1%: ±2%+0.1Ω, 5%: 3.0%±0.1Ω
Load life	负载寿命	±(3.0%±0.1Ω) 2F01: 1%: ±2%+0.1Ω, 5%: 3.0%±0.1Ω

Ordering Procedure (Example: 2F01 1/20W ±5% 10K T/R-10000)

订购方式(例如: 2F01 1/20W ±5% 10K T/R-10000)



Remark: Please refer to page 141 for ordering guide. 注: 下单请详见 P141 页说明。

Feature (特性)

- High density, more than 1 resistors in one small case 高度密集, 多个电阻在一个表贴封装中
- Improvement of placement efficiency 装配效率高
- Tape/Reel packaging is suitable for automatic placement machine 编带卷装适合自动化机器
- Superior solderability 优越焊锡性

Dimension (尺寸) (mm)



Equivalent Circuit Diagram (等效电路图)

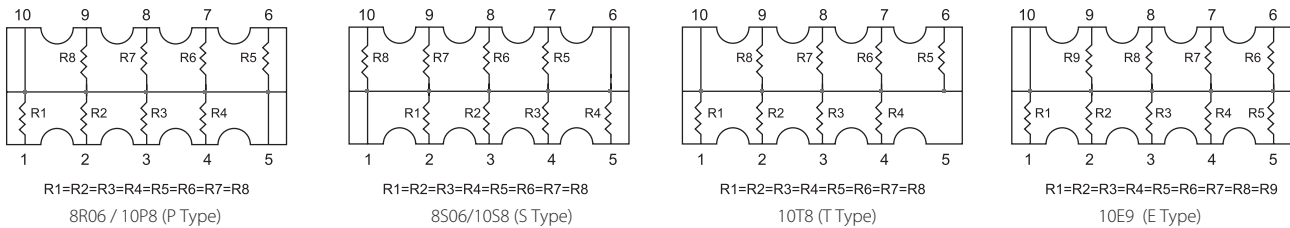

Characteristics (特性)

		10P8,10S8,10T8,10E9	8R06, 8S06
Rated Power at 70°C	功率	1/32W [1/16W special provide (可特别提供)]	1/16W
Max. Working Voltage	最大工作电压	25V	50V
Max. Overload Voltage	最大过负荷电压	50V	100V
Dielectric withstanding Voltage	绝缘耐压	50V	100V
Operating temperature	工作温度	-55°C ~ +155 °C	55°C ~ +155 °C
Resistance Range	阻值范围	10Ω~1MΩ	±1% :30Ω~1MΩ ±5% :10Ω~1MΩ
Resistance Value of Jumper	零欧姆电阻阻值	<50mΩ	/
Rated Current of Jumper	零欧姆电阻额定电流	0.5A	/

Performance Specification (性能)

Temperature Coefficient	温度系数	±200PPM/°C
Short-time overload	短时间过负荷	±(2.0% ±0.05Ω)
Insulation resistance	绝缘电阻	≥1,000MΩ
Dielectric withstanding voltage	绝缘耐压	No evidence of flashover, mechanical damage, arcing or insulation breakdown 无击穿, 飞弧及可见机械性损伤
Terminal bending	端子弯曲	±(1.0% ±0.05Ω)
Soldering heat	耐焊接热	ΔR/R ≤ ±(1.0% ±0.05Ω)
Solderability	可焊性	Coverage must be over 95%.
Load life in humidity	湿度寿命	±(3.0% ±0.1Ω)
Load life	负载寿命	±(3.0% ±0.1Ω)

• Please refer to page 12 for the information of Ordering Procedure (Part No.)
订购方式, 请参考第 12 页 (料号)

Dimension of Paper Taping (纸带尺寸)(mm)

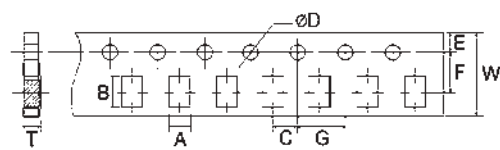

01005 0201 CQ01 2F01 4F01 PF0A NS01 0402 AS02 CQ02 HP02 HQ02 NM02
TC02 PF02 PS02 CS02 NS02 2C02 4C02 4D02 2D02 2S02 4S02

0603 CQ03 0805 CQ05 1206 CQ06 1210 CQ10 2010 CQ07 0508 0612 1020 HQ03 HQ05 HQ06 HQ07 HQ10 HP03 HP05 HP06 HP07 HP10
HV03 HV05 HV06 HV07 HV10 NM03 NM05 NM06 NS03 NS05 NS06 NS07 NS10 AS03 AS05 AS06 AS07 AS10 PS03 PS05 PS06 PS07 PS10
CS03 CS05 CS06 CS07 CS10 TC03 TC05 TC06 TC07 TC10 TR05 TR06 2F01 4F01 2D03 4D03 4C03 10P8 10S8 10T8 10E9 16P8

Type (类型)	A±0.2	B±0.2	C±0.05	ØD ^{+0.1} ₀	E±0.1	F±0.05	G±0.1	W±0.2	T±0.1
01005, PF0A	0.24±0.05	0.45±0.05	2.0	1.5	1.75	3.5	4.0	8.0	0.40
0201, CQ01, ES01, PF01, NS01, NQ01	0.40±0.05	0.70±0.05	2.0	1.5	1.75	3.5	4.0	8.0	0.42
0402, CQ02, AS02, CS02, NQ02, ES02, HP02, HQ02, PF02, LT02, NM02, TC02, PS02	0.65±0.1	1.2±0.1	2.0	1.5	1.75	3.5	4.0	8.0	0.42±0.05
0603, CQ03, AS03, PS03, NQ03, ES03, HP03, HQ03, HV03, PF03, LT03, NM03, NS03, TC03, TR03	1.10	1.90	2.0	1.5	1.75	3.5	4.0	8.0	0.67
0805, CQ05, AS05, NQ05, CS05, ES05, HP05, HV05, HQ05, PF05, LT05, LE05, MS05, NM05, NS05, PS05, TC05, TR05, WR08	1.65	2.40	2.0	1.5	1.75	3.5	4.0	8.0	0.81
1206, CQ06, AS06, NQ06, CS06, ES06, HP06, HQ06, HV06, PF06, LR06, LT06, LE06, MS06, NS06, NM06, PS06, TC06, TR06, WR12	2.00	3.60	2.0	1.5	1.75	3.5	4.0	8.0	0.81
1210, CQ07, AS07, NQ07, HQ07, HP07, CS07, ES07, HV07, PF07, PS07, AS07, TC07, NS07	2.80	3.50	2.0	1.5	1.75	3.5	4.0	8.0	0.75
2D02, 2C02, 2S02	1.20	1.20	2.0	1.5	1.75	3.5	4.0	8.0	0.45
4D02, 4C02, 4S02	1.20	2.20	2.0	1.5	1.75	3.5	4.0	8.0	0.70
2F01	0.79	1.0	2.0	1.5	1.75	3.5	4.0	8.0	0.5
4F01	0.9	1.7	2.0	1.5	1.75	3.5	4.0	8.0	0.5
2D03	1.90	1.90	2.0	1.5	1.75	3.5	4.0	8.0	0.83
4D03, 4C03, 4S03	2.00	3.60	2.0	1.5	1.75	3.5	4.0	8.0	0.83
10P8, 10S8, 10T8, 10E9	2.00	3.60	2.0	1.5	1.75	3.5	4.0	8.0	0.85
16P8	1.80	4.30	2.0	1.5	1.75	5.5	4.0	12.0	0.75

Dimension of Embossed Taping (塑胶带尺寸)(mm)



Type (类型)	A±0.2	B±0.2	C±0.05	ØD ^{+0.1} ₀	ØD ^{+0.25} ₀	E±0.1	F±0.05	G±0.1	W±0.2	T±0.1
2010, AS10, CQ10, NQ10, HQ10, HP10, CS10, HV10, NS10, MS10, LR10, PS10, PF10, TC10, WR20,	2.9	5.6	2.0	1.5	1.5	1.75	5.5	4.0	12	1.0
1812, CS11, HP11, WR18	3.5	4.8	2.0	1.5	1.5	1.75	5.5	4.0	12	1.0
2512, CQ12, AS12, CS12, NQ12, HP12, HQ12, HV12, PF11, PF12, MS12, LR12, NM12, PS12, TC12, RS12, WR25	3.5	6.7	2.0	1.5	1.5	1.75	5.5	4.0	12	1.0
8R06, 8S06	3.4	6.6	2.0	1.5	1.5	1.75	5.5	4.0	12	1.0
SP10	2.90	5.6	2.0	1.5	1.5	1.75	5.5	4.0	12	1.35
SP12	3.50	6.7	2.0	1.5	1.5	1.75	5.5	4.0	12	1.35
SP17	4.50	7.4	2.0	1.5	-	1.75	7.5	4.0	16	1.35
SP20	5.40	11.5	2.0	1.5	-	1.75	11.5	4.0	24	1.35
SP27	7.20	11.9	2.0	1.5	-	1.75	11.5	4.0	24	1.35

Dimension of Reel (卷轴尺寸)(mm)

Type (类型)	Tape 编带	Qty. / Reel 数量 / 卷装	Tape Width 纸带宽	W±1
01005, PF0A	Paper 纸带	20,000pcs	8mm	10
0201, CQ01, 2F01, 4F01, ES01, NQ01, NS01, PF01	Paper 纸带	15,000pcs	8mm	10
0402, CQ02, CS02, ES01, ES02, HP02, HQ02, LF01, LT02, NM02, NQ02, NS02, PF02, PS02, TC02	Paper 纸带	10,000pcs	8mm	10
0603, CQ03, AS03, CS03, ES03, HP03, HQ03, HV03, LT03, NM03, NS03, NQ03, PF03, PS03, TC03	Paper 纸带	5,000pcs	8mm	10
0805, CQ05, AS05, CS05, ES05, HP05, HQ05, HV05, LT05, MS05, NM05, NQ05, NS05, PF05, PS05, TC05, TR05, WR08	Paper 纸带	5,000pcs	8mm	10
1206, CQ06, AS06, CS06, ES06, HP06, HQ06, HV06, LT06, MS06, LR06, NM06, NQ06, PF06, PS06, TC06, TR06, WR12,	Paper 纸带	5,000pcs	8mm	10
1210, CQ07, AS07, CS07, NQ07, ES07, HP07, HQ07, HV07, PF07, PS07, AS07, TC07	Paper 纸带	5,000pcs	8mm	10
2010, CQ10, AS10, CS10, HP10, HQ10, HV10, PF10, MS10, LR10, NQ10, PS10, WR20	Paper 纸带	4,000pcs	12mm	13.8
WR18, 1812, CS11, HP11, TC10, PF11	Embossed 塑胶带	4,000pcs	12mm	13.8
2512, CQ12, AS12, CS12, HP12, HQ12, HV12, MS12, NM12, NQ12, PF12, PS12, TC12, WR25	Embossed 塑胶带	4,000pcs	12mm	13.8
2D02, 2C02, 2S02	Paper 纸带	10,000pcs	8mm	10
4D02, 4C02, 4S02	Paper 纸带	10,000pcs	8mm	10
2D03, 4D03, 4C03, 4S03	Paper 纸带	5,000pcs	8mm	10
10P8, 10S8, 10T8, 10E9	Paper 纸带	5,000pcs	8mm	10
16P8	Paper 纸带	4,000pcs	12mm	13.8
8R06, 8S06	Embossed 塑胶带	4,000pcs	12mm	13.8
LR12, RS12	Embossed 塑胶带 / Paper 纸带	2,000pcs	12mm	13.8
SP10, SP12	Embossed 塑胶带	2,000pcs	12mm	13.5
SP17	Embossed 塑胶带	2,000pcs	16mm	17.5
SP20, SP27	Embossed 塑胶带	1,000pcs	24mm	25.5



*Remark: 15,000 pcs/reel package could be offered for 0402 size. (备注: 0402 可提供 15,000 只包装)

Dimension of Bulk Cassette (散装盒尺寸) (mm)

36(H)×12(W)×110(L)

Bulk Cassette packing available on a case to case basis (散装可特别提供)



Feature (特性)

- High quality performance 高品质
- Great economy 低成本
- Flame Retardant available 可提供不燃性涂装
- Automatically insertable 适用自动化插件



Dimension(尺寸) mm



Derating Curve (降功率曲线)



Specification(性能)

料号	类型	Power Rating 功率 70 °C	Dimension (尺寸)(mm)					MAX. Working Voltage 最大工作 电压	MAX. Overload Voltage 最大过负荷 电压	Dielectric Withstanding Voltage 绝缘耐压	Resistance Range 阻值范围	Tolerance 公差
			D	L	d±0.05	H±3	PT					
Ordinary Products(普通产品)												
CFR0W8	CFR-12	1/8W	1.9±0.3	3.3±0.3	0.45	28	52	200V	400V	400V	1Ω~1MΩ	
CFR0S4	CFR-25-S	1/4W-S	1.9±0.3	3.3±0.3	0.45	28	52	200V	400V	400V	1Ω~1MΩ	
CFR0W4	CFR-25	1/4W	2.2±0.3	6.5±1.0	0.54	28	52	250V	500V	500V	1Ω~10MΩ	
CFR0W2	CFR-50	1/2W	3.0±0.6	9.5±1.0	0.54	28	52	350V	700V	700V	1Ω~10MΩ	
CFR01S	CFR-100-S	1W-S	4.5±0.6	11.5±1.0	0.70	25	52	500V	1000V	1000V	1Ω~10MΩ	±2%
CFR01W	CFR-100	1W	5.0±0.6	15.5±1.0	0.70	28	64	500V	1000V	1000V	1Ω~10MΩ	±5%
CFR02S	CFR-200-S	2W-S	5.0±0.6	15.5±1.0	0.70	28	64	500V	1000V	1000V	1Ω~10MΩ	±10%
CFR02W	CFR-200	2W	6.0±0.6	17.5±1.0	0.75	28	64	500V	1000V	1000V	1Ω~10MΩ	
CFR03S	CFR-300-S	3W-S	6.0±0.6	17.5±1.0	0.75	28	64	500V	1000V	1000V	1Ω~10MΩ	
High Power Products(高功率产品)												
CPR0W2	CPR-50	1/2W	2.2±0.5	6.5±1.0	0.54	28	52	300V	500V	700V	3Ω~10MΩ	±2%
CPR01W	CPR-100	1W	3.5±0.5	9.5±1.0	0.54	28	52	500V	700V	1000V	3Ω~10MΩ	±5%
CPR02W	CPR-200	2W	4.5±0.5	11.0±1.0	0.70	25	52	500V	1000V	1000V	3Ω~10MΩ	±10%

- Standard E-24 series values in ±5% ±10% & ±20% tolerance
标准 E-24 系列公差为 ±5%、±10% & ±20%
- Standard: Beige color, CFR1WS, CFR2WS, CFR3WS with light brown color, High Power Products with Grey-green
正常尺寸涂标准米黄色底漆, CFR1WS、CFR2WS、CFR3WS 涂浅棕色底漆, 高功率产品涂灰绿色底漆
- For any special inquiry such as too Low or too High ohmic values is available on a case to case basis
特殊要求, 含超高、超低阻值也可特别安排生产

Performance Specification(性能)

Temperature coefficient	温度系数	$\leq 10\ \Omega$: $\pm 300\text{PPM}/^\circ\text{C}$; $11\ \Omega \sim 99\text{k}\Omega$: $\pm 450\text{PPM}/^\circ\text{C}$; $100\text{k}\Omega \sim 1\text{M}\Omega$: $0 \sim 700\text{PPM}/^\circ\text{C}$; $1.1\text{M}\Omega \sim 10\text{M}\Omega$: $0 \sim 1500\text{PPM}/^\circ\text{C}$;
Short-time Overload	短时间过负荷	CFR Products (CFR 产品): $\Delta R/R \leq \pm(1\%+0.05\ \Omega)$ CPR Products (CPR 产品): $\Delta R/R \leq \pm(0.75\%+0.05\ \Omega)$
Dielectric withstanding voltage	绝缘耐压	With no evidence of flashover,mechanical damage,arcing or insulation breakdown (无击穿·飞弧及可见机械损伤)
Terminal strength	端子强度	No evidence of mechanical damage (无可见机械损伤)
Soldering heat	耐焊接热	$\Delta R/R \leq \pm(1\%+0.05\ \Omega)$ with no evidence of mechanical damage (无可见机械损伤)
Solderability	可焊性	Coverage must be over 95%.
Resistance to solvent	耐溶剂	No deterioration of protective coating and markings (封装层, 色码完整)
Rapid change of temperature	温度快速变化	$\Delta R/R \leq \pm(1\%+0.05\ \Omega)$ with no evidence of mechanical damage (无可见机械损伤)
Load life in humidity	湿度寿命	CFR Ordinary Products (CFR 普通产品): $\Delta R/R \pm 3\%$ for $< 100\text{k}\Omega$, $\pm 5\%$ for $\geq 100\text{k}\Omega$ CFR Flame retardant type(CFR 阻燃性): $\Delta R/R \pm 5\%$ for $< 100\text{k}\Omega$, $\pm 10\%$ for $\geq 100\text{k}\Omega$ High Power Products (高功率产品): $\Delta R/R \pm(3\%+0.05\ \Omega)$
Load life	负载寿命	CFR Ordinary Products (普通产品): $\Delta R/R \pm 2\%$ for $< 56\text{k}\Omega$, $\pm 3\%$ for $\geq 56\text{k}\Omega$ CFR Flame retardant type (CFR 阻燃性产品): $\Delta R/R \pm 5\%$ for $< 100\text{k}\Omega$, $\pm 10\%$ for $\geq 100\text{k}\Omega$ High Power Products (高功率产品): $\Delta R/R \pm(3\%+0.05\ \Omega)$

Ordering Procedure (Example: CFR 1/4WS 5% 10 Ω T/B-5000)

订购方式(例如: CFR1/4WS 5% 10 Ω T/B-5000)



Feature (特性)

- EIA standard color. EIA标准色码
- Flame Retardant type available 可提供不燃性漆
- Low noise & voltage coefficient 噪声低, 电压系数小
- Low temperature coefficient range 温度系数低
- Multiple epoxy coating on vacuum-deposited metal film provides superior moisture protection
真空溅射金属皮膜涂多层环氧树脂, 防水性效果好
- Nichrome resistive element provides stable performance in various environments
镍基金属膜层的采用使各项性能更加稳定



Dimension(尺寸) mm



Derating Curve (降功率曲线)



Specification(性能)

Part No 料号	Type 类型	Power Rating 功率 70°C	Dimension (尺寸)(mm)					MAX. Working Voltage 最大工作电压	MAX. Overload Voltage 最大过负荷电压	Dielectric Withstanding Voltage 绝缘耐压
			D	L	d±0.05	H±3	PT			
MF0W8	MF-12	1/8W	1.9±0.3	3.3±0.3	0.45	28	52	200V	400V	400V
MF0S4	MF-25-S	1/4W-S	1.9±0.3	3.3±0.3	0.45	28	52			
MF004	MF-40-SS	0.4W-SS	1.9±0.5	3.3±0.3	0.45	28	52	200V	400V	400V
MF0W4	MF-25	1/4W	2.2±0.3	6.5±1.0	0.54	28	52	250V	500V	500V
MF0S2	MF-50-S	1/2W-S	2.2±0.5	6.5±1.0	0.54	28	52	250V	500V	250V
MF0W2	MF-50	1/2W	3.0±0.6	9.5±1.0	0.54	28	52	350V	700V	700V
MF006	MF-60-S	0.6W-S	2.2±0.5	6.5±1.0	0.54	28	52	250V	500V	500V
MF01S	MF-100-S	1W-S	3.0±0.6	9.5±1.0	0.54	28	52	350V	700V	700V
MF01W	MF-100	1W	4.5±0.6	11.5±1.0	0.70	25	52	500V	1000V	1000V
MF02S	MF-200-S	2W-S	4.5±0.6	11.5±1.0	0.70	25	52	500V	1000V	1000V
MF02W	MF-200	2W	5.0±0.6	15.5±1.0	0.70	28	64	500V	1000V	1000V
MF03S	MF-300-S	3W-S	5.0±0.6	15.5±1.0	0.70	28	64	500V	1000V	1000V
MF03W	MF-300	3W	6.0±0.6	17.5±1.0	0.75	28	64	500V	1000V	1000V

Part No 料号	Type 类型	Standard Order 标准品			Special Order 特殊订购品		
		Tolerance 公差	Resistance Range 阻值范围	TCR 温度系数	Tolerance 公差	Resistance Range 阻值范围	TCR 温度系数
MF0W8	MF0W8	±1%	10Ω~1MΩ	±50	±0.25%	51.1Ω~200KΩ	±15
MF0S4	MF0S4	±2%	10Ω~1MΩ	±100	±0.5%	51.1Ω~511KΩ	±25
MF004	MF004	±5%	1Ω~1MΩ	±200	±0.5%	51.1Ω~511KΩ	±50
MF0W4	MF-25	±1%	10Ω~1MΩ	±50	±0.1%	10Ω~1MΩ	±15
MF0S2	MF-50-S	±2%	1Ω~1MΩ	±100	±0.25%	10Ω~1MΩ	±25
MF006	MF-60-S	±5%	1Ω~1MΩ	±200	±0.5%	10Ω~1MΩ	±50
MF0W2	MF-50	±1%	10Ω~1MΩ	±50	±0.1%	100Ω~330KΩ	±15
MF01S	MF-100-S	±2%	10Ω~1MΩ	±100	±0.25%	51.1Ω~511KΩ	±25
		±5%	1Ω~1MΩ	±200	±0.5%	10Ω~1MΩ	±50
MF01W	MF-100	±1%	51.1Ω~1MΩ	±50	±0.1%	100Ω~330KΩ	±15
MF02S	MF-200-S	±2%	51.1Ω~1MΩ	±100	±0.25%	51.1Ω~511KΩ	±25
MF02W	MF-200						
MF03S	MF-300-S						
MF03W	MF-300	±5%	1Ω~1MΩ	±200	±0.5%	51.1Ω~1MΩ	±50

Performance Specification(性能)

Short-time Overload	短时间过负荷	$\Delta R/R \leq \pm(0.5\%+0.05 \Omega)$, with no evidence of mechanical damage (无可见机械损伤)
Dielectric withstanding voltage	绝缘耐压	With no evidence of flashover, mechanical damage, arcing or insulation breakdown (无击穿·飞弧及可见机械损伤)
Pulse Overload	脉冲过负荷	$\Delta R/R \leq \pm (1\%+0.05)$, with no evidence of mechanical damage (无可见机械损伤)
Terminal strength	端子强度	No evidence of mechanical damage (无可见机械损伤)
Soldering heat	耐焊接热	$\Delta R/R \leq \pm(1\%+0.05 \Omega)$ with no evidence of mechanical damage (无可见机械损伤)
Solderability	可焊性	Coverage must be over 95%.
Resistance to solvent	耐溶剂	No deterioration of protective coating and markings (包封层, 色码完整)
Rapid change of temperature	温度快速变化	$\Delta R/R \leq \pm(1\%+0.05 \Omega)$ with no evidence of mechanical damage (无可见机械损伤)
Load life in humidity	湿度寿命	Normal type(普通型): $\Delta R/R \leq \pm 1.5\%$ & Flame retardant type(阻燃性): $\Delta R/R \leq \pm 5\%$
Load life	负载寿命	Normal type(普通型): $\Delta R/R \leq \pm 1.5\%$ & Flame retardant type(阻燃性): $\Delta R/R \leq \pm 5\%$

Ordering Procedure (Example: MF 1/8W 1% 47.5K Ω T/R-5000)

订购方式(例如: MF 1/8W 1% 47.5K Ω T/R-5000)



New/Old Part.no Contrast (新旧料号对照)

New Part.no 新料号	Old Part.no 旧料号	New Part.no 新料号	Old Part.no 旧料号
MF0W8FF****A*0	MFR0W8F****A*0	MF01SFF****A*0	MFR01SF****A*0
MF0S4FF****A*0	MFR0S4F****A*0	MF01WFF****A*0	MFR01WF****A*0
MF004FF****A*0	MFR004F****A*0	MF02SFF****A*0	MFR02SF****A*0
MF0W4FF****A*0	MFR0W4F****A*0	MF02WFF****A*0	MFR02WF****A*0
MF0S2FF****A*0	MFR0S2F****A*0	MF03SFF****A*0	MFR03SF****A*0
MF0W2FF****A*0	MFR0W2F****A*0	MF03WFF****A*0	MFR03WF****A*0
MF006FF****A*0	MFR006F****A*0		

Feature (特性)

- High power in small body size 体积小功率高
- Excellent flame Retardant coating 优异不燃性涂装
- High stability even in bad environment 恶劣环境下同样稳定工作
- Match the safety requirement 满足安全标准要求



Dimension(尺寸) mm



Derating Curve (降功率曲线)



Part No 料号	Type 类型	Power Rating 功率 70°C	Dimension (尺寸)(mm)					MAX.Working Voltage 最大工作 电压	MAX.Overload Voltage 最大过负荷 电压	Dielectric Withstanding Voltage 绝缘耐压	Resistance Range 阻值范围
			D	L	d±0.05	H±3	PT				
PMR01S	PMR-100-S	1WS	2.2±0.5	6.5±1.0	0.54	28	52	500V	600V	350V	10Ω~10MΩ
PMR02S	PMR-200-S	2WS	4.0±0.6	11.0±1.0	0.70	25	52	500V	600V	350V	3.9Ω~680KΩ
PMR03S	PMR-300-S	3WS	5.0±0.6	15.5±1.0	0.75	28	64	750V	800V	350V	12Ω~180KΩ

Performance Specification(性能)

Temperature coefficient	温度系数	1WS: ±200PPM/°C (± 2%); ±250PPM/°C (±5%) 2WS: ±350PPM/°C (3.9Ω~100KΩ); ±400PPM/°C (101KΩ~680KΩ) 3WS: ±350PPM/°C (12Ω~100KΩ); ±400PPM/°C (101KΩ~180KΩ)
Short-time Overload	短时间过负荷	ΔR/R ≤ ±(2%+0.05 Ω), with no evidence of mechanical damage (无可见机械损伤)
Terminal strength	端子强度	with no evidence of mechanical damage (无可见机械损伤)
Soldering heat	耐焊接热	ΔR/R ≤ ±(1%+0.05 Ω), with no evidence of mechanical damage (无可见机械损伤)
Solderability	可焊性	Coverage must be over 95%.
Rapid change of temperature	温度快速变化	ΔR/R ≤ ±(2%+0.05 Ω) with no evidence of mechanical damage (无可见机械损伤)
Load life in humidity	湿度寿命	1WS: ΔR/R ≤ ±(5%+0.05 Ω) 2WS&3WS: <100KΩ: ΔR/R ≤ ±(5%+0.05 Ω) ≥100KΩ: ΔR/R ≤ ±(10%+0.05 Ω)
Load life	负载寿命	1WS: ΔR/R ≤ ±(5%+0.05 Ω) 2WS&3WS: <100KΩ: ΔR/R ≤ ±(5%+0.05 Ω) ≥100KΩ: ΔR/R ≤ ±(10%+0.05 Ω)
Flame retardant	阻燃	Resistor insulation is self-extinguishing within 10 seconds after externally applied flame is removed 火焰移开后 10 秒内, 电阻自动绝燃, 无可见火焰

Ordering Procedure (Example: PMR1WS 5% 100Ω T/B-5000)

订购方式 (例如: PMR1WS 5% 100Ω T/B-5000)



New/Old Part.no Contrast (新旧料号对照)

New Part.no 新料号	Old Part.no 旧料号
PMR01SJ****A*0	MPR01WJ****A*0
PMR03SJ****A*0	MPR03WJ****A*0

Feature (特性)

- Excellent flame retardant coating 优异不燃性涂装
- High stability even in bad environment 恶劣环境下同样稳定工作
- High purity ceramic core 高纯度瓷芯
- Meet EIA-RC2655A requirements 满足EIA-RC2655A标准要求
- High safety standard 满足安全性标准要求



Dimension(尺寸) mm



Derating Curve (降功率曲线)

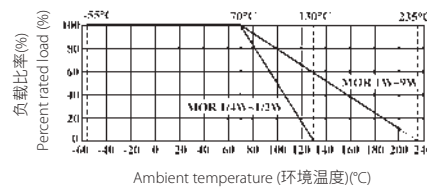

Heat Rise Chart (表面温升)



Specification(性能)

Part No. 料号	Type 类型	Power Rating 功率 70°C	Dimension (尺寸)(mm)					MAX. Working Voltage 最大工作电压	MAX. Overload Voltage 最大过负荷电压	Dielectric Withstanding Voltage 绝缘耐压	Resistance Range 阻值范围
			D	L	d ±0.05	H±3	PT				
MOR0W4	MOR-25	1/4W	2.2±0.5	6.5±1.0	0.54	28	52	250V	400V	250V	0.1Ω~470KΩ
MOR0S2	MOR-50-S	1/2W-S	2.2±0.5	6.5±1.0	0.54	28	52	250V	400V	250V	0.1Ω~470KΩ
MOR0W2	MOR-50	1/2W	3.0±0.6	9.5±1.0	0.54	28	52	250V	400V	250V	0.1Ω~560KΩ
MOR01S	MOR-100-S	1W-S	3.5±0.6	9.5±1.0	0.54	28	52	350V	600V	350V	0.1Ω~560KΩ
MOR01W	MOR-100	1W	4.5±0.6	11.5±1.0	0.70	25	52	350V	600V	350V	0.1Ω~560KΩ
MOR02S	MOR-200-S	2W-S	4.5±0.6	11.5±1.0	0.70	25	52	350V	600V	350V	0.1Ω~560KΩ
MOR02W	MOR-200	2W	5.0±0.6	15.5±1.0	0.70	28	64	350V	600V	350V	0.1Ω~560KΩ
MOR03S	MOR-300-S	3W-S	5.0±0.6	15.5±1.0	0.70	28	64	350V	600V	350V	0.1Ω~560KΩ
MOR03W	MOR-300	3W	6.0±0.6	17.5±1.0	0.75	28	64	500V	800V	500V	0.1Ω~560KΩ
MOR05S	MOR-500-S	5W-S	6.0±0.6	17.5±1.0	0.75	28	64	500V	800V	500V	0.1Ω~560KΩ
MOR05W	MOR-500	5W	8.0±0.6	24.5±1.0	0.75	38	90	750V	1000V	750V	0.1Ω~680KΩ
MOR07W	MOR-700	7W	8.0±0.6	29.5±1.0	0.75	38	B/B	750V	1000V	750V	20Ω~150KΩ
MOR08W	MOR-800	8W	8.0±0.6	39.5±1.0	0.75	38	B/B	750V	1000V	750V	30Ω~200KΩ
MOR09W	MOR-900	9W	8.0±0.6	52.5±1.0	0.75	38	B/B	750V	1000V	750V	50Ω~200KΩ

- Standard E-24 Series ±5% tolerance 标准 E-24 系列 ±5% 公差阻值
- Standard Gray base color for Normal Size product, Blue color for Small Size product 正常尺寸产品涂灰色底漆, 小尺寸产品涂海蓝色底漆
- Standard Non-Flammable coating 标准不燃性涂装
- Non-Inductive type available on a case to case basis 无感, 可特别生产

Performance Specification(性能)

Temperature coefficient	温度系数	1/4W,1/2WS: $\leq 100K\Omega$: $\pm 350PPM/^{\circ}C$; $100K\Omega < R \leq 470K\Omega$: $0 \sim 700PPM/^{\circ}C$ 1/2W,1WS: $\leq 120K\Omega$: $\pm 350PPM/^{\circ}C$; $120K\Omega < R \leq 560K\Omega$: $0 \sim 700PPM/^{\circ}C$ 1W,2W,2WS,3W,3WS,5WS: $\leq 150K\Omega$: $\pm 350PPM/^{\circ}C$; $150K\Omega < R \leq 560K\Omega$: $0 \sim 700PPM/^{\circ}C$ 5W; $\leq 180K\Omega$: $\pm 350PPM/^{\circ}C$; $180K\Omega < R \leq 680K\Omega$: $0 \sim 700PPM/^{\circ}C$ 7W,8W, 9W: $\pm 350PPM/^{\circ}C$
Short-time Overload	短时间过负荷	Normal size(正常尺寸), $\Delta R/R \leq \pm(1\%+0.05\Omega)$, with no evidence of mechanical damage (无可见机械损伤) Small size(小尺寸), $\Delta R/R \leq \pm(2\%+0.05\Omega)$, with no evidence of mechanical damage (无可见机械损伤)
Dielectric withstanding voltage	绝缘耐压	No evidence of flashover, mechanical damage, arcing or insulation breakdown (无击穿、飞弧及可见机械损伤)
Pulse Overload	脉冲过负荷	Normal size(正常尺寸), $\Delta R/R \leq \pm(2\%+0.05\Omega)$, with no evidence of mechanical damage (无可见机械损伤) Small size(小尺寸), $\Delta R/R \leq \pm(5\%+0.05\Omega)$, with no evidence of mechanical damage (无可见机械损伤)
Terminal strength	端子强度	No evidence of mechanical damage (无可见机械损伤)
Soldering heat	耐焊接热	$\Delta R/R \leq \pm(1\%+0.05\Omega)$, with no evidence of mechanical damage (无可见机械损伤)
Solderability	可焊性	Coverage must be over 95%.
Resistance to solvent	耐溶剂	No deterioration of protective coating and markings (包封层, 色码完整)
Rapid change of temperature	温度快速变化	$\Delta R/R \leq \pm(2\%+0.05\Omega)$ with no evidence of mechanical damage (无可见机械损伤)
Humidity (Steady State)	恒定湿热	$\Delta R/R \leq \pm(2\%+0.05\Omega)$ with no evidence of mechanical damage (无可见机械损伤)
Load life in humidity	湿度寿命	$< 100k\Omega$: $\pm(5\%+0.05\Omega)$ $\geq 100k\Omega$: $\pm(10\%+0.05\Omega)$
Load life	负载寿命	$< 100k\Omega$: $\pm(5\%+0.05\Omega)$ $\geq 100k\Omega$: $\pm(10\%+0.05\Omega)$
Flame retardant	阻燃	Resistor insulation is self-extinguishing within 10 seconds after externally applied flame is removed (火焰移开后 10 秒内, 电阻自动绝燃, 无可见火焰)

Ordering Procedure (Example: MOR 1W-S 5% 8.2 Ω T/B-1000)

订购方式(例如: MOR 1W-S 5% 8.2 Ω T/B-1000)



Feature (特性)

- Excellent flame retardant coating 优异不燃性涂装
- High Stability even in bad environment 恶劣环境下同样稳定工作
- High purity ceramic core 高纯度瓷芯
- High safety standard 电器性能稳定
- Meet EIAJ-RC2655A requirements 达到 EIAJ-RC2655A 标准要求
- Too low or too high ohmic value can be provided on a case to case basis 超低或超高阻值也能特别提供



Vertical type - TMOV

端片 MOR 电阻-立式 (TMOV)

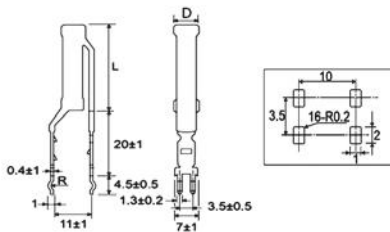

"L" type terminal - TMOL

端片 MOR 电阻-L型端片 (TMOL)

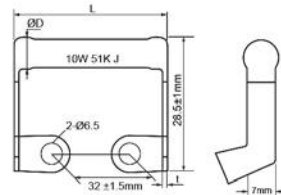

Radial type - TMOR

端片 MOR 电阻-卧式 (TMOR)

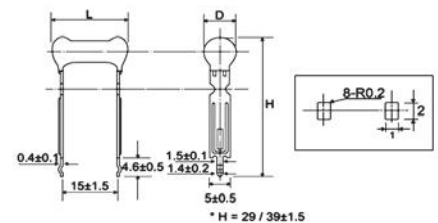

Specification(性能)

Part No 料号	Type 类型	Power Rating 功率 70°C	Dimension(尺寸) (mm)		MAX. Working Voltage 最大工作电压	MAX. Overload Voltage 最大过负荷电压	Resistance Range 阻值范围	Tolerance 精度 (%)
			L±1	D±1				
TMOV5W	TMOV-500	5W	20	7	500V	800V	≤ 10Ω 10Ω~10KΩ	±10% ±5%
TMOV7W	TMOV-700	7W	30	7	500V	800V	≤ 10Ω 10Ω~10KΩ	±10% ±5%
TMOLAW	TMOL-10W	10W	46Max 最大	10Max 最大	500V	800V	100Ω~82KΩ	±5%
TMOL13	TMOL-13W	13W	47	10	750V	1000V	100Ω~82KΩ	±5%
TMOR3W	TMOR-300	3W	16	6	350V	600V	≤ 10Ω 10Ω~43KΩ	±10% ±5%
TMOR5W	TMOR-500	5W	18	7	500V	800V	≤ 10Ω 10Ω~43KΩ	±10% ±5%

Ordering Procedure (Example: TMOV5W 5% 1KΩ B/B)

订购方式 (例如: TMOV5W 5% 1KΩ B/B)



Feature (特性)

- Provide high stable performance against environment conditions & overload voltage
耐高压, 稳定性强, 抗湿热高温环境
- Can withstand High Surge Voltage 可承受高浪涌电压
- Wide resistance range & low TCR 阻值范围宽, 温度系数低
- VDE items available (File NO:40003686, A414, D708, A759)
产品VDE 认证(认证号:40003686, A414, D708, A759)
- UL items available (File NO:20130925-E364163, E244546)
产品UL安规 认证(认证号:20130925-E364163, E244546)



The tolerance $\pm 5\%$ has five color codes, and the last one is marked in black
公差 $\pm 5\%$ 有五道色码, 最后一道以黑色标示

Tolerance $\pm 1\%$ with 5 color codes
公差 $\pm 1\%$ 有 5 道色码

Dimension (尺寸) mm



Surge Withstanding Voltage (承受浪涌电压)



Derating Curve (降功率曲线)



- Normal size: The discharge cycle is repeated in above circuit: 2.5 seconds "ON", 2.5 "OFF", 50 cycles, C=0.001uf.
正常尺寸: 右图中充放电回路: 2.5 秒 "通", 2.5 秒 "断", 50 次循环, 电容容值 C=0.001uf.
- Small Size: The discharge cycle is repeated in above circuit: 2.5 seconds "ON", 2.5 seconds "OFF", 10 cycles, C=0.01uf.
小型化产品: 右图中充放电回路: 2.5 秒 "通", 2.5 秒 "断", 10 次循环, 电容容值 C=0.01uf.
- The applied DC source voltage is shown as below table. 电路中的直流电压如下表 "承受浪涌电压" 所述.

Specification (性能)

Part No 料号	Type 类型	Power Rating 功率 70°C	Dimension (尺寸) (mm)				MAX. Working Voltage 最大工作 电压	MAX. Overload Voltage 最大过负 荷电压	Dielectric Withstanding Voltage 绝缘耐压	Surge Withstanding Voltage 浪涌电压	Resistance Range 阻值范围
			D	L	d ± 0.05	H ± 3					
Normal Size (正常尺寸)											
MGR0W4	MGR-25	1/4W	2.2 ± 0.5	6.5 ± 1.0	0.60	28	1,600V	2,000V	700V		1K Ω ~510M Ω ($\pm 5\%$, $\pm 10\%$)
MGR0W2	MGR-50	1/2W	3.5 ± 0.6	9.5 ± 1.0	0.60	28	3,500V	4,000V	700V		$\leq 10M\Omega$ ($\pm 1\%$) 10M~100M ($\pm 2\%$)
MGR01W	MGR-100	1W	4.0 ± 0.6	11.5 ± 1.0	0.75	25	3,500V	4,000V	1000V	$\geq 100K\Omega$ 1000V	1K Ω ~1G Ω ($\pm 5\%$, $\pm 10\%$)
MGR02W	MGR-200	2W	5.0 ± 0.6	15.5 ± 1.0	0.80	28	3,500V	4,000V	1000V		$\leq 10M\Omega$; $\pm 1\%$ 10M~100M ($\pm 2\%$)
MGR03W	MGR-300	3W	6.0 ± 0.6	17.5 ± 1.0	0.80	28	3,500V	4,000V	1000V		1K Ω ~100M Ω ($\pm 5\%$, $\pm 10\%$) 100K~1M ($\pm 1\%$)
Small Size & Ultra Small Size (小型尺寸)											
MGR0S2	MGR-50-S	1/2W-S	2.2 ± 0.5	6.5 ± 1.0	0.60	28	500V	700V	500V	100K Ω ~1M: 3000V 1M1~6M2: 4000V $\geq 6M8$: 6000V	
MGR01S	MGR-100-S	1W-S	3.5 ± 0.6	9.5 ± 1.0	0.60	28	700V	1000V	700V	100K Ω ~1M: 4000V 1M1~6M2: 5000V $\geq 6M8$: 8000V	1K Ω ~33M Ω ($\pm 5\%$, $\pm 10\%$)
MGR02S	MGR-200-S	2W-S	4.5 ± 0.6	11.5 ± 1.0	0.75	25	1000V	1400V	700V	100K Ω ~1M: 5000V 1M1~6M2: 6000V $\geq 6M8$: 9000V	100K Ω ~1M Ω ($\pm 1\%$)
MGR03U	MGR-300-SS	3W-SS	4.5 ± 0.6	11.5 ± 1.0	0.75	25	1000V	1400V	700V		
MGR03S	MGR-300-S	3W-S	5.0 ± 0.6	15.5 ± 1.0	0.80	28	1000V	1400V	700V	100K Ω ~1M: 8000V 1M1~6M2: 9000V $\geq 6M8$: 10000V	

Performance Specification(性能)

Temperature coefficient	温度系数	≤±200PPM°C
Short-time Overload	短时间过负荷	ΔR/R ≤ ±(1%+0.05 Ω), with no evidence of mechanical damage (无可见机械损伤)
Dielectric withstanding voltage	绝缘耐压	With no evidence of flashover, mechanical damage, arcing or insulation breakdown (无击穿·电弧及可见机械损伤)
Pulse Overload	脉冲过负荷	ΔR/R ≤ ±(2%+0.05), with no evidence of mechanical damage (无可见机械损伤)
Terminal strength	端子强度	No evidence of mechanical damage (无可见机械损伤)
Soldering heat	耐焊接热	ΔR/R ≤ ±(1%+0.05 Ω) with no evidence of mechanical damage (无可见机械损伤)
Solderability	可焊性	Coverage must be over 95%.
Resistance to solvent	耐溶剂	No deterioration of protective coating and marking (包封层, 色码完整)
Rapid change of temperature	温度快速变化	ΔR/R ≤ ±(1%+0.05 Ω) with no evidence of mechanical damage (无可见机械损伤)
Load life in humidity	湿度寿命	ΔR/R ≤ ±(5%+0.05 Ω) with no evidence of mechanical damage (无可见机械损伤)
Load life	负载寿命	ΔR/R ≤ ±(5%+0.05 Ω) with no evidence of mechanical damage (无可见机械损伤)
Surge Withstanding Voltage	尖峰脉冲	ΔR/R ≤ ±(20%+0.05 Ω) with no evidence of mechanical damage (无可见机械损伤)

Ordering Procedure (Example: MGR 1W 5% 27MΩ T/B-1000)

订购方式 (例如: MGR 1W 5% 27MΩ T/B-1000)



New/Old Part.no Contrast (新旧料号对照)

New Part.no 新料号	Old Part.no 旧料号
MGR0**J*****	HMGR**J*****
MGR0**J*****	HVR0**J*****
MGR*S2*****	MGR*U2*****

Remark: Please refer to page 141 for ordering guide. 注: 下单请详见 P141 页说明。

Feature (特性)

- Ideal circuit opening controller, disconnecting units from overload rating specified.
理想的电流过负荷保护组件
- Too low or too high ohmic value can be supplied on a case to case to case basis.
超高或超低阻值也能特别生产
- UL items available (File NO:E306074, E245468)
产品UL安规认证(认证号:E306074、E245468)



Dimension (尺寸) mm

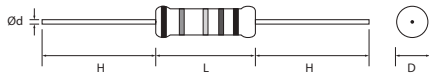

Derating Curve (降功率曲线)



Specification (性能)

Part No 料号	Type 类型	Power Rating 功率 70°C	Dimension (尺寸)(mm)					Dielectric Withstanding Voltage 绝缘耐压	Resistance Range 阻值范围
			D	L	d ±0.05	H±3	PT		
FRN0W4	FRN-25	1/4W	2.2±0.5	6.5±1.0	0.60	28	52	300V	0.22Ω~10KΩ
FRN0S2	FRN-50-S	1/2W-S	2.2±0.5	6.5±1.0	0.60	28	52	300V	0.22Ω~10KΩ
FRN004	FRN-40	0.4W	2.2±0.5	6.5±1.0	0.60	28	52	300V	0.22Ω~10KΩ
FRN0W2	FRN-50	1/2W	3.0±0.5	9.0±1.0	0.60	28	52	350V	0.22Ω~10KΩ
FRN075	FRN-75	3/4W	3.5±0.6	9.5±1.0	0.54	28	52	350V	0.22Ω~10KΩ
FRN01W	FRN-100	1W	3.5±0.6	9.5±1.0	0.54	28	52	350V	0.22Ω~10KΩ
FRN01A	FRN-150	1.5W	4.5±0.6	11.5±1.0	0.70	25	52	600V	0.22Ω~10KΩ
FRN02W	FRN-200	2W	4.5±0.6	11.5±1.0	0.70	25	52	600V	0.22Ω~10KΩ
FRN03W	FRN-300	3W	5.0±0.6	15.5±1.0	0.80	28	64	600V	0.22Ω~10KΩ

Fusing Characteristics (熔断特性)

Resistance Value (阻值)	Test Wattage (测试功率)	Fusing Time (熔断时间)
≤2.2Ω	32 X Power Rating (额定功率)	≤ 60 seconds (秒)
>2.2Ω	16 X Power Rating (额定功率)	≤ 60 seconds (秒)

The fusing test current or voltage should be stable, change within 5%. (测试电流或电压必须稳定变化率不超过 5%)

Performance Specification(性能)

Temperature coefficient	温度系数	±350PPM/°C
Short-time Overload	短时间过负荷	$\Delta R/R \leq \pm(2\%+0.05 \Omega)$, with no evidence of mechanical damage (无可见机械损伤)
Dielectric withstanding voltage	绝缘耐压	With no evidence of flashover, mechanical damage, arcing or insulation breakdown (无击穿·飞弧及可见机械损伤)
Terminal strength	端子强度	No evidence of mechanical damage (无可见机械损伤)
Soldering heat	耐焊接热	$\Delta R/R \leq \pm(1\%+0.05 \Omega)$ with no evidence of mechanical damage (无可见机械损伤)
Solderability	可焊性	Coverage must be over 95%.
Rapid change of temperature	温度快速变化	$\Delta R/R \leq \pm(2\%+0.05 \Omega)$ with no evidence of mechanical damage (无可见机械损伤)
Load life in humidity	湿度寿命	$\Delta R/R \leq \pm(5\%+0.05 \Omega)$ with no evidence of mechanical damage (无可见机械损伤)
Load life	负载寿命	$\Delta R/R \leq \pm(5\%+0.05 \Omega)$ with no evidence of mechanical damage (无可见机械损伤)
Flame retardant	阻燃	Resistor insulation is self-extinguishing within 10 seconds after externally applied flame is removed (火焰移开后 10S 内, 电阻自动绝燃, 无可见火焰)

Ordering Procedure (Example: FRN 1W 5% 1Ω T/B-1000)

订购方式(例如: FRN 1W 5% 1Ω T/B-1000)

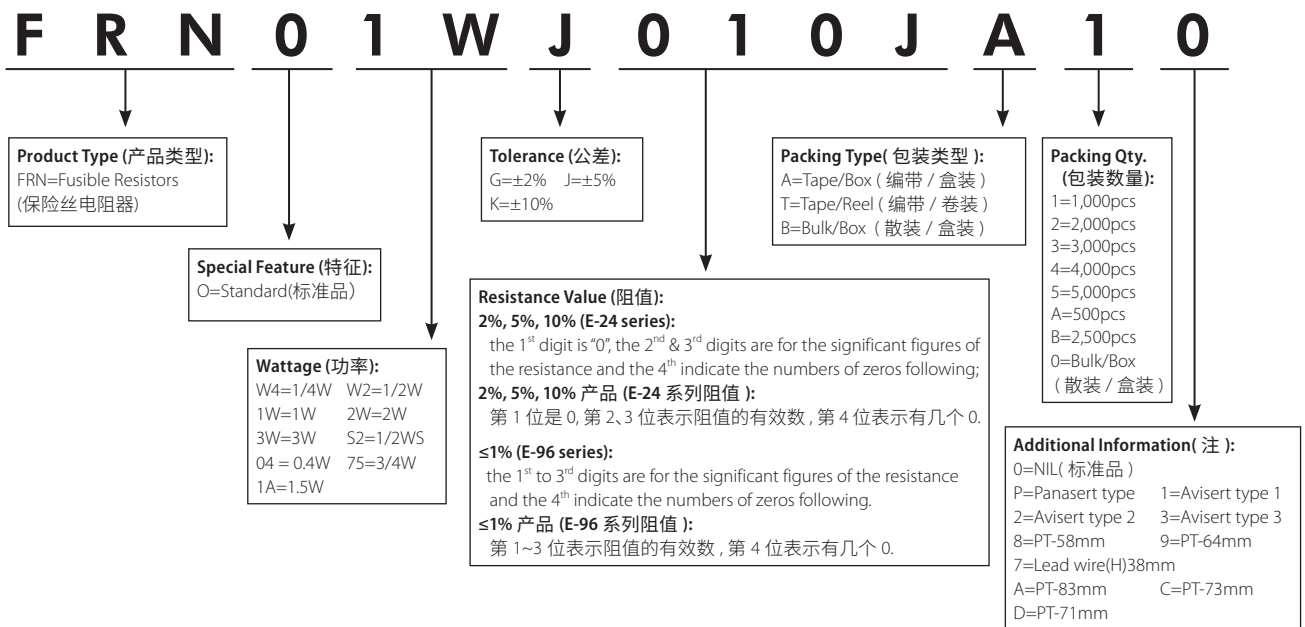

Remark: Please refer to page 141 for ordering guide. 注: 下单请详见 P141 页说明。

Feature (特性)

- Excellent flame retardant coating 优异不燃性涂装
- Too low or too high ohmic value can be supplied on a case to basis
超低阻值或超高阻值都可特别提供
- Non-inductive type available
可特别提供无感型产品



Dimension(尺寸) mm



Derating Curve (降功率曲线)



Specification(性能)

Part No 料号	Type 类型	Power Rating 功率 70°C	Dimension (尺寸)(mm)					Resistance Range 阻值范围
			D±1	L±1	d ±0.05	H±3	PT	
KNP0W4	KNP-25	1/4W	2.5	6.5	0.54	28	52	0.01Ω~200Ω
KNP0S2	KNP-50-S	1/2WS	2.5	6.5	0.54	28	52	0.01Ω~200Ω
KNP0W2	KNP-50	1/2W	3.0	9.5	0.54	28	52	0.01Ω~390Ω
KNP01S	KNP-100-S	1W-S	3.0	9.5	0.54	28	52	0.01Ω~390Ω
KNP01W	KNP-100	1W	4.5	11.5	0.70	25	52	0.01Ω~1.2KΩ
KNP02S	KNP-200-S	2W-S	4.5	11.5	0.70	25	52	0.01Ω~1.2KΩ
KNP02W	KNP-200	2W	5.5	15.5	0.70	28	64	0.01Ω~3.0KΩ
KNP03S	KNP-300-S	3W-S	5.5	15.5	0.70	28	64	0.01Ω~3.0KΩ
KNP03W	KNP-300	3W	6.5	17.5	0.75	28	64	0.039Ω~3.9KΩ
KNP05S	KNP-500-S	5W-S	6.5	17.5	0.75	28	64	0.039Ω~3.9KΩ
KNP05W	KNP-500	5W	8.5	24.5	0.75	38	90	0.082Ω~5.6KΩ
KNP07S	KNP-700-S	7W-S	8.5	24.5	0.75	38	90	0.082Ω~5.6KΩ
KNP07W	KNP-700	7W	8.5	29.5	0.75	38	B/B	0.1Ω~8.2KΩ
KNP08S	KNP-800-S	8W-S	8.5	29.5	0.75	38	B/B	0.1Ω~8.2KΩ
KNP08W	KNP-800	8W	8.5	39.5	0.75	38	B/B	0.15Ω~12KΩ
KNP09S	KNP-900-S	9W-S	8.5	39.5	0.75	38	B/B	0.15Ω~12KΩ
KNP09W	KNP-900	9W	8.5	52.5	0.75	38	B/B	0.22Ω~15KΩ
KNP0AS	KNP-1000-S	10W-S	8.5	52.5	0.75	38	B/B	0.22Ω~15KΩ

KNS Type (KNS型)



Derating Curve (降功率曲线)



Part No 料号	Type 类型	Power Rating 功率 70°C	Dimension (尺寸)(mm)						Resistance Range 阻值范围
			D±1	L±1.5	P ±1.0	H±1.0	h±1.0	B±0.5	
KNS02W	KNS-200	2W	7.0	19.0	8	19	12	4.5	0.05Ω~470Ω
KNS03W	KNS-300	3W	7.0	21.0	10	19	13	4.5	0.068Ω~470Ω
KNS05W	KNS-500	5W	9.0	26.0	15	21.5	13	6.5	0.01Ω~750Ω
KNS07W	KNS-700	7W	9.0	31.0	20	21.5	13	6.5	0.1Ω~1.1KΩ
KNS08W	KNS-800	8W	9.0	41.0	32.5	21.5	13	6.5	0.2Ω~2.2KΩ
KNS0AW	KNS-1000	10W	9.0	54.0	43	21.5	13	6.5	0.3Ω~3.3KΩ

KNH Type (KNH型)



KNHA Type (KNHA型)



Part No 料号	Type 类型	Power Rating 功率 70°C	Dimension (尺寸)(mm)				Resistance Range 阻值范围
			A±1.5	B±1.5	C ±3	D±1	
KNH020	KNH-20W	20W	19	50	19	5	0.4Ω~10KΩ
KNH025	KNH-25W	25W	19	60	19	5	0.4Ω~10KΩ
KNH030	KNH-30W	30W	19	75	19	5	0.5Ω~15KΩ
KNH040	KNH-40W	40W	19	90	19	5	0.6Ω~20KΩ
KNH050	KNH-50W	50W	31	75	31	8	3Ω~25KΩ
			28				
KNH060	KNH-60W	60W	31	90	31	8	3Ω~30KΩ
			28				
KNH080	KNH-80W	80W	31	115	31	8	3Ω~40KΩ
			28				
KNH.....100	KNH-100W	100W	31	140	31	8	3Ω~50KΩ
			28				
KNHA25	KNHA-25W	25W	21	41	24	5	0.4Ω~10KΩ
KNHA30	KNHA-30W	30W	21	42	24	5	0.4Ω~10KΩ

Feature (特性)

- Excellent flame retardant coating 优异不燃性漆
- Too low or too high ohmic value can be supplied on a case to case basis 超低或超高阻值都可特别提供
- Non-inductive production process 无感的制作工艺

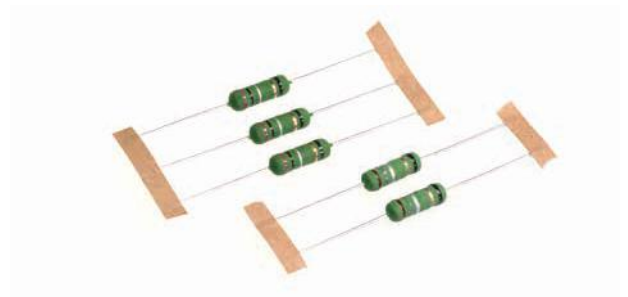

Dimension(尺寸) mm



Derating Curve (降功率曲线)



Part No 料号	Type 类型	Dimension (尺寸)(mm)					Resistance Range 阻值范围
		D±1	L±1	d±0.05	H±3	PT	
KNPNW2	KNPN-50	3.0	9.5	0.54	28	52	0.01Ω~30Ω
KNPN1S	KNPN-100-S	3.0	9.5	0.54	28	52	
KNPN1W	KNPN-100	4.0	11.5	0.70	25	52	0.01Ω~62Ω
KNPN2S	KNPN-200-S	4.0	11.5	0.70	25	52	
KNPN2W	KNPN-200	5.5	15.5	0.70	28	64	0.018Ω~120Ω
KNPN3S	KNPN-300-S	5.5	15.5	0.70	28	64	
KNPN3W	KNPN-300	6.5	17.5	0.75	28	64	0.024Ω~150Ω
KNPN5S	KNPN-500-S	6.5	17.5	0.75	28	64	
KNPN5W	KNPN-500	8.5	24.5	0.75	38	90	0.043Ω~430Ω
KNPN7S	KNPN-700-S	8.5	24.5	0.75	38	90	
KNPN7W	KNPN-700	8.5	29.5	0.75	38	B/B	0.047Ω~430Ω
KNPN8S	KNPN-800-S	8.5	29.5	0.75	38	B/B	
KNPN8W	KNPN-800	8.5	39.5	0.75	38	B/B	0.091Ω~620Ω
KNPN9S	KNPN-900-S	8.5	39.5	0.75	38	B/B	
KNPN9W	KNPN-900	8.5	52.5	0.75	38	B/B	0.13Ω~820Ω
KNPNAS	KNPN-1000-S	8.5	52.5	0.75	38	B/B	

Performance Specification(性能)

Temperature coefficient	温度系数	≥20Ω: ±300PPM/°C; < 20Ω: ±400PPM/°C
Short-time Overload	短时间过负荷	ΔR/R ≤ ±(2%+0.05Ω)Max, with no evidence of mechanical damage (无可见机械损伤)
Terminal strength	端子强度	No evidence of mechanical damage (无可见机械损伤)
Soldering heat	耐焊接热	ΔR/R ≤ ±(1%+0.05Ω)Max, with no evidence of mechanical damage (无可见机械损伤)
Solderability	可焊性	Coverage must be over 95%.
Load life in humidity	湿度寿命	ΔR/R ≤ ±(5%+0.05Ω)Max, with no evidence of mechanical damage (无可见机械损伤)
Load life	负载寿命	ΔR/R ≤ ±(5%+0.05Ω)Max, with no evidence of mechanical damage (无可见机械损伤)
Resistance to solvent	耐溶剂	No evidence of mechanical damage (无可见机械损伤)

Ordering Procedure (Example: KNP 3WS 5% 12Ω T/B-1000)

订购方式 (例如: KNP 3WS 5% 12Ω T/B-1000)



Feature (特性)

- Excellent flame retardant coating (优异不燃性涂装)
- According to IEC 61000-4-5 (符合 IEC61000-4-5 标准)
- Applies to electricity meters, home appliance and ballast (适用于电表、家电及整流器产品)



Dimension(尺寸) mm



Derating Curve (降功率曲线)



KNPA Pulses Energy Curve (KNPA耐脉冲能量曲线)

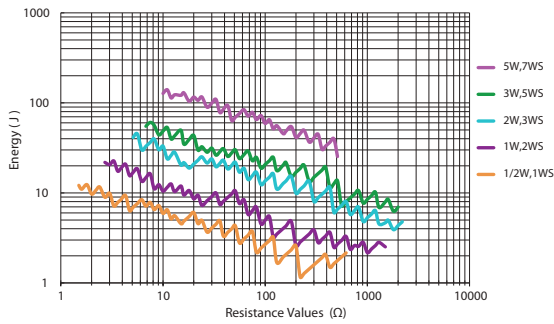

KNPA Pulses Voltage Curve (KNPA耐脉冲电压曲线)



Part No 料号	Type 类型	Dimension (尺寸)(mm)					Resistance Range 阻值范围
		D±1	L±1	d±0.05	H±3	PT	
KNPAW2,01S	KNPA-50,KNPA-100-S	3.5	9.5	0.54	28	52	10Ω~820Ω
KNPA1W,02S	KNPA-100,KNPA-200-S	4.5	11.5	0.70	25	52	10Ω~1.2KΩ
KNPA2W,03S	KNPA-200,KNPA-300-S	5.5	15.5	0.70	28	64	10Ω~3.0KΩ
KNPA3W,05S	KNPA-300,KNPA-500-S	6.5	17.5	0.75	28	64	10Ω~3.9KΩ
KNPA5W,07S	KNPA-500,KNPA-700-S	8.5	24.5	0.75	38	90	10Ω~5.6KΩ
KNPA7W,08S	KNPA-700,KNPA-800-S	8.5	29.5	0.75	38	B/B	10Ω~8.2KΩ
KNPA8W,09S	KNPA-800,KNPA-900-S	8.5	39.5	0.75	38	B/B	10Ω~10KΩ
KNPA9W,AS	KNPA-900,KNPA-1000-S	8.5	52.5	0.75	38	B/B	10Ω~15KΩ

Performance Specification(性能)

Temperature coefficient	温度系数	±200PPM/°C
Short-time Overload	短时间过负荷	ΔR/R±(2%+0.05Ω)MAX, with no evidence of mechanical damage (无可见机械损伤)
Terminal strength	端子强度	No evidence of mechanical damage (无可见机械损伤)
Soldering heat	耐焊接热	ΔR/R±(1%+0.05Ω) MAX, with no evidence of mechanical damage (无可见机械损伤)
Solderability	可焊性	Coverage must be over 95%.
Rapid change of temperature	温度快速变化	ΔR/R±(2%+0.05Ω) MAX, with no evidence of mechanical damage (无可见机械损伤)
Load life in humidity	湿度寿命	ΔR/R±(5%+0.05Ω) MAX, with no evidence of mechanical damage (无可见机械损伤)
Load life	负载寿命	ΔR/R±(5%+0.05Ω) MAX, with no evidence of mechanical damage (无可见机械损伤)
Surge Immunity	脉冲测试	ΔR/R±(5%+0.05Ω) MAX
Resistance to solvent	耐溶剂	No evidence of mechanical damage (无可见机械损伤)

Surge Rating(脉冲标准)

Type 类型	Low Resistance Range 低阻值范围	Maximum Surge Voltage 最大脉冲电压	Medium Resistance Range 中阻值范围	Maximum Surge Voltage 最大脉冲电压	High Resistance Range 高阻值范围	Maximum Surge Voltage 最大脉冲电压
KNPA1/2W、1WS	10Ω~40Ω	2KV	43Ω~240Ω	3KV	270Ω~820Ω	4KV
KNPA1W、2WS	10Ω~50Ω	3KV	51Ω~240Ω	4KV	270Ω~1.2KΩ	5KV
KNPA2W、3WS	10Ω~100Ω	4KV	110Ω~240Ω	5KV	270Ω~3.0KΩ	6KV
KNPA3W、5WS	10Ω~100Ω	6KV	110Ω~680Ω	7KV	750Ω~3.9KΩ	8KV
KNPA5W、7WS	10Ω~160Ω	7KV	180Ω~680Ω	8KV	750Ω~5.6KΩ	9KV
KNPA7W、8WS	10Ω~160Ω	8KV	180Ω~680Ω	9KV	750Ω~8.2KΩ	10KV
KNPA8W、9WS	10Ω~160Ω	9KV	180Ω~680Ω	10KV	750Ω~10KΩ	10KV
KNPA9W、10WS	10Ω~160Ω	10KV	180Ω~680Ω	10KV	750Ω~15KΩ	10KV

Ordering Procedure (Example: KNPA 3WS 5% 12Ω T/B-1000)

订购方式 (例如: KNPA3WS 5% 12Ω T/B-1000)



New/Old Part.no Contrast (新旧料号对照)

New Part.no 新料号	Old Part.no 旧料号
KNPA**j*****	KSRO**j*****

Feature (特性)

- Suitable for all kinds of protection circuit 适用各种保护电路
- Non-flammable coating, could withstand High Temperature
优异不燃性涂装, 耐高温
- Common resistor with additional safety function, no flame or smoke, no explosion or coating crack when fusing
常见的电阻器具有额外的安全性能, 无火焰或烟, 无爆炸或涂层裂纹
- UL items available (File NO:E306074)
产品 UL 安规认证 (认证号: E306074)



Dimension(尺寸) mm



Derating Curve (降功率曲线)

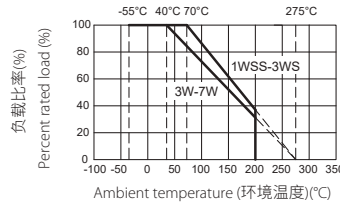

Fuseing Curve (熔断曲线)

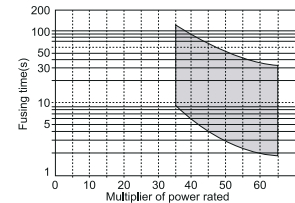

Part No 料号	Type 类型	Power Rating 功率 70 °C	Dimension (尺寸)(mm)					Resistance Range 阻值范围
			D(Max)	L(Max)	H±3	d±0.05	PT	
KNPU1U	KNPU1W-SS	1W-SS	3.0	8.5	28	0.54	52	10Ω
KNPU1S	KNPU1W-S	1W-S	4.3	9.0	28	0.60	52	0.47Ω~240Ω
KNPU1S	KNPU1W-S	1W-S	4.3	10.0	28	0.75	52	0.47Ω~240Ω
KNPU1W	KNPU100	1W	5.0	12.0	25	0.70	52	0.47Ω~240Ω
KNPU2S	KNPU2W-S	2W-S	5.0	12.0	25	0.70	52	0.47Ω~240Ω
KNPU2W	KNPU200	2W	5.5	16.0	28	0.70	64	0.47Ω~240Ω
KNPU3S	KNPU3W-S	3W-S	5.5	16.0	28	0.70	64	0.47Ω~240Ω
KNPU3W	KNPU300	3W	6.5	17.5	28	0.75	64	0.47Ω~240Ω
KNPU5W	KNPU500	5W	8.0	20.0	38	0.75	B/B	0.47Ω~240Ω
KNPU7W	KNPU700	7W	8.5	25.0	38	0.75	B/B	0.47Ω~47Ω

Performance Specification(性能)

Temperature coefficient	温度系数	≥20 Ω: ±300PPM/°C <20 Ω: ±400PPM/°C
Short-time Overload	短时间过负荷	ΔR/R ≤±(2%±0.05Ω), with no evidence of mechanical damage (无可见机械损伤)
Dielectric withstanding voltage	绝缘耐压	No evidence of flashover, mechanical damage.(1000V). 无击穿、飞弧及可见机械损伤 (1000V)
Terminal strength	端子强度	No evidence of mechanical damage (无可见机械损伤)
Soldering heat	耐焊接热	ΔR/R ≤±(1%±0.05Ω), with no evidence of mechanical damage (无可见机械损伤)
Solderability	可焊性	Coverage must be over 95%.
Load life in humidity	湿度寿命	ΔR/R ≤±(5%±0.05Ω), with no evidence of mechanical damage (无可见机械损伤)
Load life	负载寿命	ΔR/R ≤±(5%±0.05Ω), with no evidence of mechanical damage (无可见机械损伤)

Ordering Procedure (Example: KNPU 3WS 5% 12Ω T/B-1000)

订购方式 (例如: KNPU3WS 5% 12Ω T/B-1000)

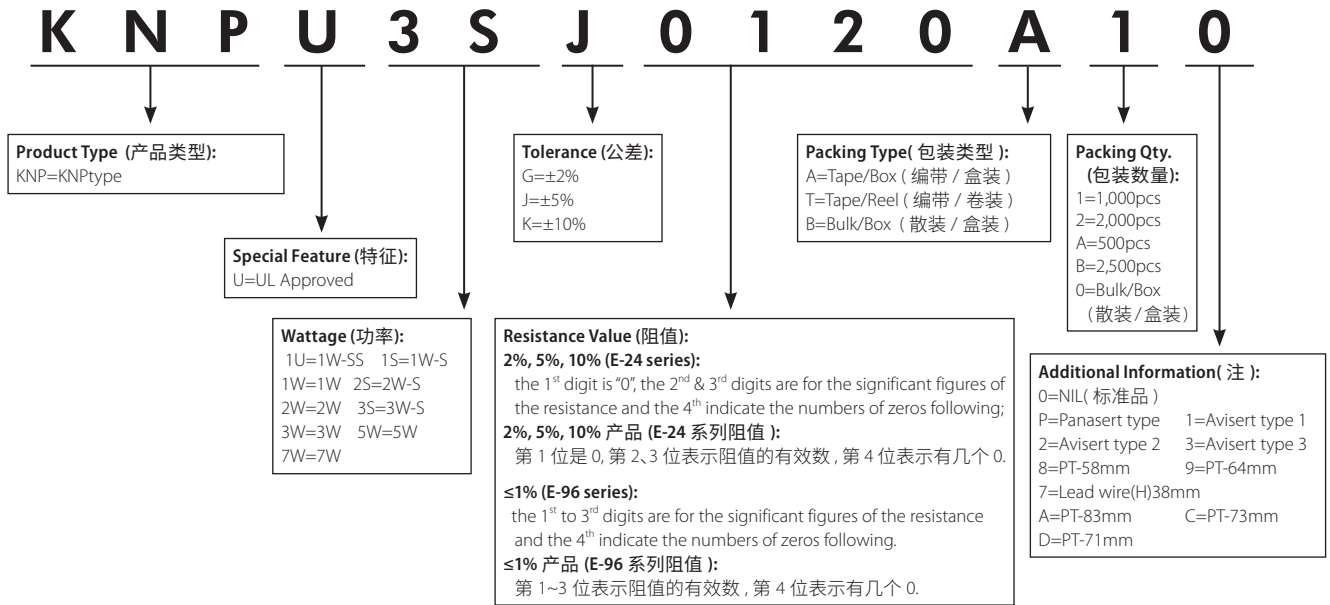

Feature (特性)

- Small body size 体积小
- High power 功率大
- Excellent flame retardant coating 优异的阻燃封装
- Provides stable performance in various environments 在各种环境中提供优异的稳定性



Dimension(尺寸) mm



Derating Curve (降功率曲线)



Surge Withstanding Curve (脉冲曲线)

100ms Single Pulse Power-Value Chart (100ms 单脉冲曲线)



Part No 料号	Type 类型	Power Rating 功率 70°C	Dimension (尺寸)(mm)				Max Working Voltage 最大工作电压	Dielectric Withstand Voltage 绝缘耐压	Resistance Range 阻值范围
			D±1	L±1	d±0.05	H±3			
WPR01W	WPR-100	1W	2.5	6.2	0.60	28	50V	250V	0.1Ω~300Ω
WPR02W	WPR-200	2W	3.5	9.0	0.75	28	50V	250V	0.1Ω~1KΩ
WPR03W	WPR-300	3W	4.5	10.5	0.75	25	50V	350V	0.1Ω~1KΩ
WPR04W	WPR-400	4W	5.5	15.5	0.75	28	50V	350V	0.1Ω~1.8KΩ
WPR0AU	WPR-1000-SS	10W-SS	8.5	39.5	0.75	38	50V	350V	1Ω~5KΩ

Performance Specification(性能)

Temperature coefficient	温度系数	±200PPM/°C
Short-time Overload	短时间过负荷	ΔR/R≤±(5.0%+0.05Ω) with no evidence of mechanical damage (无可见机械损伤)
Terminal strength	端子强度	No evidence of mechanical damage (无可见机械损伤)
Soldering heat	耐焊接热	ΔR/R≤±(1.0%+0.05Ω) with no evidence of mechanical damage (无可见机械损伤)
Solderability	可焊性	Coverage must be over 95%.
Rapid change of temperature	温度快速变化	ΔR/R≤±(2.0%+0.05Ω) with no evidence of mechanical damage (无可见机械损伤)
Humidity (Steady State)	恒定湿热	ΔR/R≤±(2.0%+0.05Ω) with no evidence of mechanical damage (无可见机械损伤)
Pulse test	脉冲测试	ΔR/R≤±(5.0%+0.05Ω)
Resistance to solvent	耐溶剂	No deterioration of protective coating and markings (封装层, 色码完整)
Load life in humidity	湿度寿命	ΔR/R≤±(5.0%+0.05Ω) Max. with no evidence of mechanical damage (无可见机械损伤)
Load life	负载寿命	ΔR/R≤±(5.0%+0.05Ω) Max. with no evidence of mechanical damage (无可见机械损伤)

Ordering Procedure (Example: WPR1W 5% 100Ω T/B-1000)

订购方式 (例如: WPR1W 5% 100Ω T/B-1000)

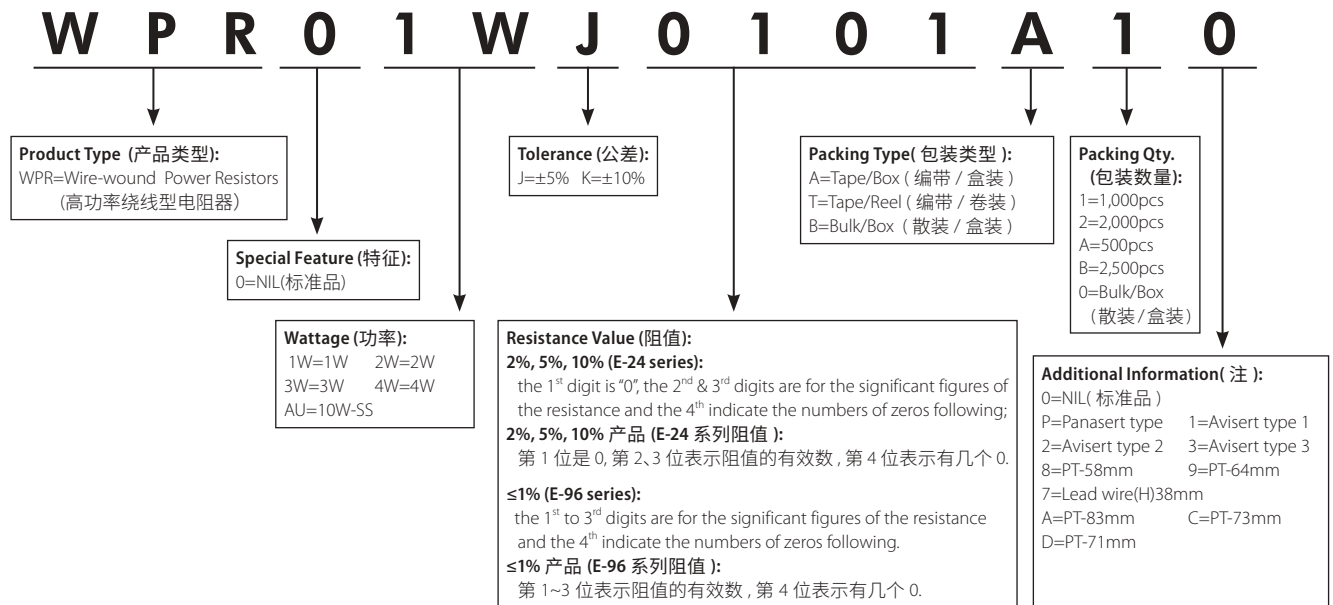

New/Old Part.no Contrast (新旧料号对照)

New Part.no 新料号	Old Part.no 旧料号
WPR01W****A*0	KNP01UJ****A*0
WPR02W****A*0	KNP02UJ****A*0
WPR03W****A*0	KNP03UJ****A*0
WPR04W****A*0	KNP04UJ****A*0
WPR0AU****A*0	KNP0AUJ****A*0

Feature (特性)

- Low resistance value with higher power dissipation 低阻值高功耗
- Wire-wound resistor with thermal fuse protection 绕线电阻热熔断保护
- Used in Electronic ballast, other lighting applications
一般用在电子整流器及其它照明用途

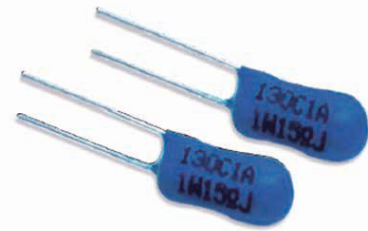

Dimension(尺寸) mm

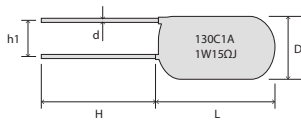

Derating Curve (降功率曲线)

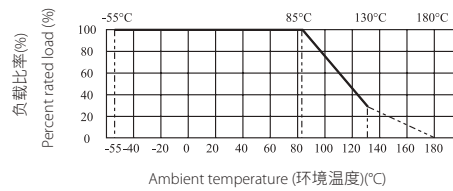

Type 类型	Power Rating 功率 70°C	Dimension (尺寸)(mm)										Resistance Range 阻值范围	
		D	L	H (Min)	h1 (Min)	d±0.02	Current Rating	TF (°C)	TH/TC (°C)	TM (°C)	Ir		Ur
TFR	1W	5.5±0.5	14±1	12	3.5	0.53	2A	130	102	180	2	250	2.2Ω~4.7Ω
TFR	1W	5.5 ⁺¹ _{-0.5}	11(Max)	12	3.5	0.53	1A	130	102	180	1	250	

Ordering Procedure (Example: TFR1W 5% 4.7Ω B/B)

订购方式 (例如: TFR1W 5% 4.7Ω B/B)

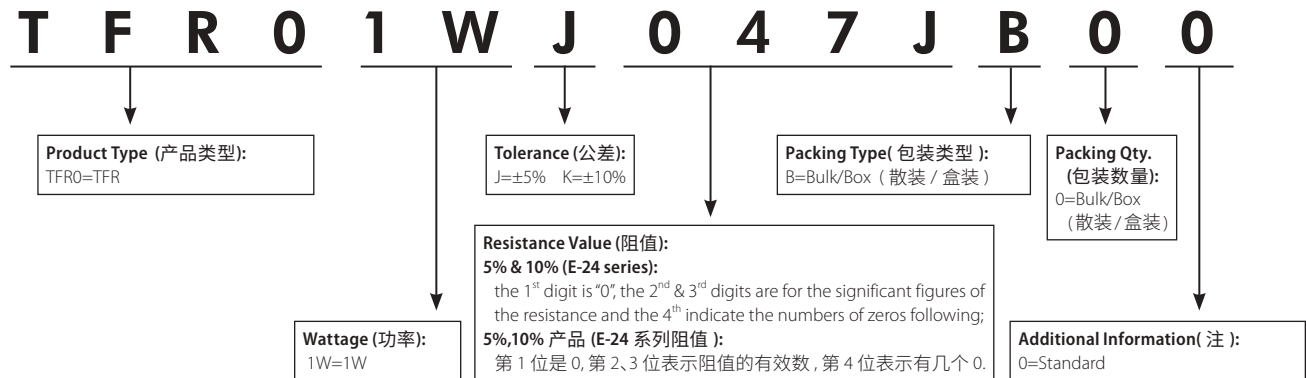

ZW Type (ZW 型)



Part No 料号	Type 类型	L±3	d±0.05	O±1	
ZWA0	ZW-A	60/34	0.45	52	26
ZWB0	ZW-B	60/34	0.54	52	26
ZWB1	ZW-B1	60/34	0.60	52	26
ZWC0	ZW-C	60/34	0.70	52	26
ZWD0	ZW-D	60/34	0.75	52	26
ZWE0	ZW-E	60/34	1.00	52	26

ZO Type (ZO 型)



Part No 料号	Type	Power Rating 功率 70°C	Dimension (尺寸)(mm)				Resistance Range 阻值范围 (≤mΩ)
			D±0.3	L	d±0.05	H±3	
ZOT0W8/ZOCOW8	ZO-12	1/8W	1.9	3.3±0.3	0.45	28	ZOT: 10 ZOC: 50
ZOT0W4/ZOCOW4	ZO-25	1/4W	2.2	6.5±1.0	0.54	28	

Performance Specification(性能)

Lead material 引线材料	Tin-Plated copper (镀锡铜线)
Insulation resistance 绝缘阻值	Dry(干态)-10,000MΩ,Wet(湿态)-100MΩ
Dielectric withstanding voltage 绝缘耐压	Atmospheric (正常气压)-500V RMS; Reduced (减压)-325VRMS;
Rated current 额定电流	1/8W70°C 1.5A, 1/4W 70°C 2.5A Derating to 0 Amps at 150°C 1/8W70°C 1.5A, 1/4W 70°C 2.5A 150°C时, 电流降低到 0A

Ordering Procedure (Example: ZOC 1/4W 0Ω T/R-5000)

订购方式(例如: ZOC 1/4W 0Ω T/R-5000)

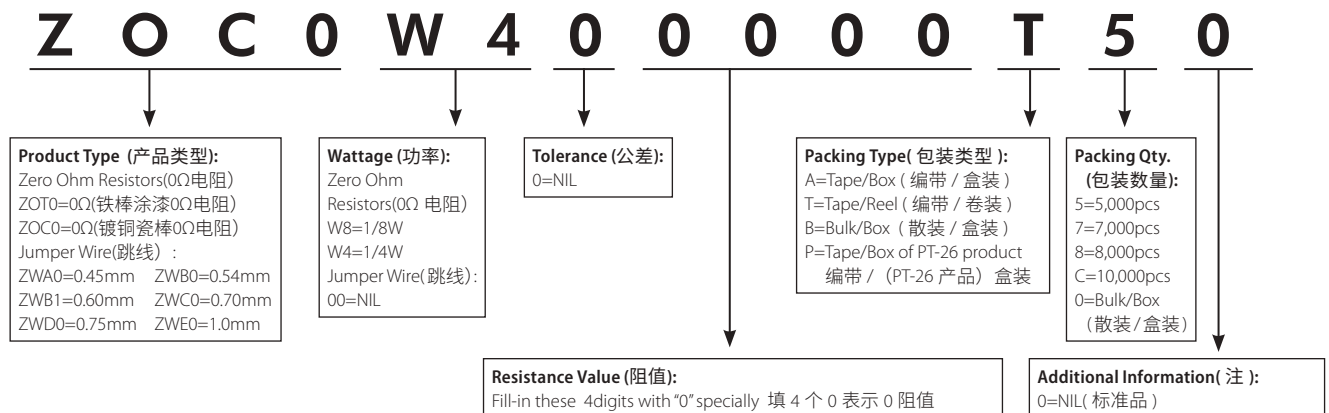

New/Old Part.no Contrast (新旧料号对照)

New Part.no 新料号	Old Part.no 旧料号	New Part.no 新料号	Old Part.no 旧料号
ZOC**00000A*0	CFR0**00000A*0	ZWB10000000A*0	ZWF00000000A*0
ZOT**00000A*0	ZO00**00000A*0	ZWE00000000A*0	ZWF00000000A*0

*M-type jumpers can be customized on request *M型跳线可特别提供

Copper Plated Steel Wire [铜包钢 (CP型)]

Tin Plated Copper Steel Lead Wire [镀锡铜包钢 (CT型)]



Part No 料号	Type 类型	Power Rating 功率 70°C	Dimension (尺寸)(mm)				MAX.Working Voltage 最大工作电压	MAX.Overload Voltage 最大过负荷电压	Dielectric Withstanding Voltage 绝缘耐压	Resistance Range 阻值范围
			D	L	d±0.05	H±3				
CPXXW8/CTXXW8	CP/CT12	1/8W	1.9±0.3	3.3±0.3	0.54	28	200V	400V	400V	1Ω~10MΩ
CPXXW4/CTXXW4	CP/CT25	1/4W	2.2±0.5	6.5±1.0	0.54	28/38	250V	500V	500V	1Ω~10MΩ
CPXXS3/CTXXS3	CP/CT33-S	1/3W-S	2.2±0.5	6.5±1.0	0.54	28/38	300V	600V	500V	1Ω~10MΩ
CPXXW3/CTXXW3	CP/CT33	1/3W	3±0.5	9.0±1.0	0.54	28	300V	600V	700V	1Ω~10MΩ
CPXXS2/CTXXS2	CP/CT50-S	1/2W-S	3±0.5	9.0±1.0	0.54	28	350V	700V	700V	1Ω~10MΩ

Cutting Type (CO) [切割半成品型 (CO) 型]



Part No. 料号	Type 类型	Power Rating 功率 70°C	Dimension (尺寸)(mm)		Resistance Range 阻值范围
			D	L	
CO...W8	CO-12	1/8W	1.6 ^{+0.10} _{-0.00}	3.2 ±0.10	1Ω ~ 10MΩ
CO...W4	CO-25	1/4W	2.1 ^{+0.09} _{-0.00}	5.6 ^{+0.10} _{-0.20}	1Ω ~ 10MΩ
CO...W4...A	CO-25-A	1/4W	2.1 ^{+0.09} _{-0.00}	5.9 ^{+0.10} _{-0.15}	1Ω ~ 10MΩ
CO...W4...B	CO-25-B	1/4W	2.1 ^{+0.09} _{-0.01}	6.4 ^{+0.10} _{-0.15}	1Ω ~ 10MΩ

• Cutting type resistors are produced without lead-wire and without coating
切割型半成品型电阻无导线，无涂装

• Cap plated option: 1. Tin-plated 2. Nickel-Plated
铁帽：1 镀锡 2 镀镍

Ordering Procedure (Example: CTO 1/4W 5% 10Ω T/B-5000, CTO lead wire)

订购方式 (例如: CTO 1/4W 5% 10Ω T/B-5000, CTO导线)



Feature (特性)

- This specification is applicable for CFR 1/4W,1/2W,1WS&CPR1/2W&MF1/4W,1/2WS,1/2W,1WS,2WS&MOR1/4W,1WS,2WS, KNP1/4W,1/2WS,1WS,2WS product only. KNP2WS product only; For other product (size), please consult factory for the available specification and drawing..

下图规格适用于 CFR1/4W,1/2W,1WS&CPR1/2W&MF1/4W,1/2WS,1/2W,1WS,2WS&MOR1/4W,1WS,2WS,KNP1/4W,1/2WS,1WS,2WS. 其它产品的立式加工, 可洽询工厂以取得可生产的规格图样。

- Standard product is insulated lead wire, insulated coating length 1/4W: 9.5±1mm; 1WS:13±1mm; 2WS:15±1mm
标准为绝缘引线, 绝缘涂层长度为:
1/4W: 9.5±1mm
1WS: 13±1mm
2WS: 15±1mm

Panasert Type 1:



Panasert Type 1:



Panasert Type 2:



Items(项目)	Symbol	Dimension 尺寸 (mm)			
		1/4W	1/2WS	1WS	2WS
Body diameter 本体直径	D	2.5 (Max)	3±0.5	3.5±0.5	4±0.5
Body length 本体长度	L	6.8 (Max)	9±1	9±1	11.5±1
Body height 本体高度	H	12 (Max)	17 (Max)	19 (Max)	21 (Max)
Lead-wire diameter 导线直径	d	0.60±0.05	0.60±0.05	0.70±0.05	0.70±0.05
Pitch of component 零件间距	p	12.7±1	12.7±1	12.7±1	12.7±1
Feed hole pitch 孔距	P ₀	12.7±0.3	12.7±0.3	12.7±0.3	12.7±0.3
Hole center to lead 中心测量	P ₁	3.85±0.7	3.85±0.7	3.85±0.7	3.85±0.7
Hole center to body 孔心至本体	P ₂	6.35±1.3	6.35±1.3	6.35±1.3	6.35±1.3
Lead to lead distance 两脚导线中心测量	F	5±1	5±1	5±1	5±1
Component alignment 零件偏移	Δh	0±1	0±1	0±1	0±1
Tape width 纸带宽度	W	18±1	18+1/-1.5	18+1/-1.5	18+1/-1.5
Sticky tape width 热熔胶带宽	W ₀	12.5 (Min) 6 (min)	/ 6±0.2	12.5 (Min) 6±0.2	12.5 (Min) 6±0.2
Hole position 孔位	W ₁	9±0.5	9+0.75/-0.5	9+0.75/-0.5	9+0.75/-0.5
Uncovered paper tape width 纸带露出宽度	W ₂	1.5 (Max)	1.5 (Max)	1.5 (Max)	1.5 (Max)
Lead-wire clinch height 导线固定高度	H ₀	16.5 (Max)	16±0.5	16±0.5	16±0.5
Length of snipped lead 导线剪断高度	H ₁	11 (Max)	11 (Max)	11 (Max)	11 (Max)
Feed hole diameter 孔径	D ₀	4±0.3	4±0.3	4±0.3	4±0.3
Total tape thickness 胶带厚度	t	0.5±0.2	0.5±0.2	0.5±0.2	0.5±0.2
Lead wire protrusion 导线露出	i	1Max	-	-	-
Length of lead cut 切脚的长度	H ₁ -w ₁	2±0.5	2±0.5	2±0.5	2±0.5

Avisert(1) Type【Avisert(1)型】

- This specification is applicable for CFR1/4W,CPR1/2W&MF1/4W,1/2WS,0.6WS,MOR1/4W,1/2WS,product only; For other product (size), please consult factory for the specification and drawing.
适用于 CFR1/4W, CPR1/2W & MF1/4W, 1/2WS, 0.6WS, MOR1/4W, 1/2WS 固定电阻。其它产品的立式加工, 可洽询工厂以取得可生产的规格图样。
- Standard product is insulated lead wire,insulated coating length $9.5\pm 1\text{mm}$
标准为绝缘引线, 绝缘涂层长度为: $9.5\pm 1\text{mm}$ 。



Items (项目)	Symbol	Dimension 尺寸 (mm)
		1/4W
Body diameter 本体直径	D	2.5 (Max)
Body length 本体长度	L	6.8 (Max)
Lead-wire diameter 导线直径	d	0.60 ± 0.05
Pitch of component 零件间距	p	12.7 ± 1
Feed hole pitch 孔距	P0	12.7 ± 0.3
Hole center to lead 中心测量	P1	3.85 ± 0.7
Lead to lead distance 两脚导线中心测量	F	5 ± 1
Tape width 纸带宽度	W	18 ± 1
Sticky tape width 热熔胶带宽	W0	12.5 (Min) 6 (min)
Hole position 孔位	W1	9.5 ± 0.5
Uncovered paper tape width 纸带露出宽度	W2	3.0 (Max)
Height of component from tape center 零件至纸带中间的宽度	H	17.3 ± 0.5
Lead-wire clinch height 导线固定高度	H0	16.5 (Max)
Component height 零件高度	H1	34.5 (Max)
Length of snipped lead 导线剪断高度	H2	11 (Max)
Feed hole diameter 孔径	D0	4 ± 0.3
Total tape thickness 胶带厚度	t	0.5 ± 0.2
Lead wire protrusion 导线露出	i	1 (Max)

Avisert(2) Type【Avisert(2)型】

- This specification is applicable for CFR1/8W, 1/4WS&MF1/8W, 1/4WS product only; For other product available forming products, please consult factory for the specification and drawing.
适用于 CFR1/8W, 1/4WS&MF1/8W, 1/4WS 固定电阻。其它产品的立式加工, 可洽询工厂以取得可生产的规格图样。



Items (项目)	Symbol	Dimension 尺寸 (mm)
		1/8W
Body diameter 本体直径	D	1.85 (Max)
Body length 本体长度	L	3.5 (Max)
Lead-wire diameter 导线直径	d	0.45 ± 0.05
Pitch of component 零件间距	p	12.7 ± 1
Feed hole pitch 孔距	P0	12.7 ± 0.3
Hole center to lead 中心测量	P1	3.85 ± 0.7
Hole center to component center 孔心至零件中心距离	P2	6.35 ± 1.3
Lead to lead distance 两脚导线中心测量	F	5 ± 1
Tape width 纸带宽度	W	18 ± 1
Sticky tape width 热熔胶带宽	W0	6 (Min)
Hole position 孔位	W1	9.0 ± 0.5
Uncovered paper tape width 纸带露出宽度	W2	3.0 (Max)
Lead wire protrusion 打弯处到纸带中心位置	H	21.25 (Max)
Component height 零件高度	H1	32.25 (Max)
Length of snipped lead 导线剪断高度	H2	11 (Max)
Feed hole diameter 孔径	D0	4 ± 0.3
Total tape thickness 胶带厚度	t	0.5 ± 0.2
Lead wire protrusion 导线露出	i	1 (Max)

Avisert(3) Type【Avisert(3)型】

- This specification is applicable for CFR1/8W, CFR1/4WS, MF1/8W, MF1/4WS, MF1/4W, MF1/2WS, MF0.6WS, MOR1/4W, MOR1/2WS. For other product (size), please consult factory for the specification and drawing.
下图规格适用于 CFR1/8W,CFR1/4WS,MF1/8W,MF1/4WS,MF1/4W,MF1/2WS,MF0.6WS,MOR1/4W,MOR1/2WS; 其它产品的立式加工, 可洽询工厂以取得可生产的规格图样。
- Standard product is insulated lead wire,insulated coating length 9.5±1mm.
标准品为绝缘引线, 绝缘涂层长度为:9.5±1mm.

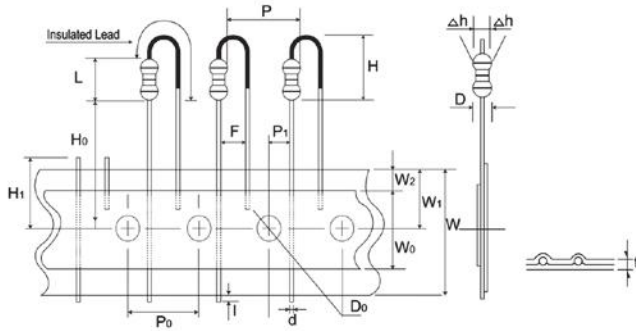

Items (项目)	Symbol	Dimension 尺寸 (mm)	
		1/8W	1/4W
Body diameter 本体直径	D	2.0 (Max)	2.5 (Max)
Body length 本体长度	L	4.2 (Max)	6.8 (Max)
Lead-wire diameter 导线直径	d	0.45±0.05	0.60±0.05
Pitch of component 零件间距	p	12.7±1	12.7±1
Feed hole pitch 孔距	P0	12.7±0.3	12.7±0.3
Hole center to lead 中心测量	P1	3.85±0.7	3.85±0.7
Lead to lead distance 两脚导线中心测量	F	2.5±1	5±1
Tape width 纸带宽度	W	18±1	18±1
Sticky tape width 热熔胶带宽	W0	6min	6min
Hole position 孔位	W1	9.0±0.5	9.0±0.5
Uncovered paper tape width 纸带露出宽度	W2	3.0 (Max)	3.0 (Max)
Body height 本体高度	H	7.0 (Max)	10.0 (Max)
Lead-wire clinch height 导线固定高度	H0	20.0 (Max)	16.0 (Max)
Component alignment 零件偏移	Δh	0±1	0±1
Length of snipped lead 导线剪断高度	H1	11 (Max)	11 (Max)
Feed hole diameter 孔径	D0	4±0.3	4±0.3
Total tape thickness 胶带厚度	t	0.5±0.2	0.5±0.2
Lead wire protrusion 导线露出	i	1 (Max)	1 (Max)

Ordering Procedure (Example: CFR1/4W 5% 100KΩ T/B-2000 PANASERT Type)

订购方式 (例如: CFR1/4W 5% 100KΩ T/B-2000 PANASERT Type)



F Forming Type (F 型)

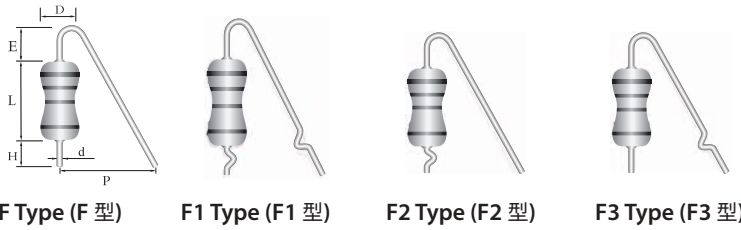

Dimension (尺寸) (mm)

Power Rating 功率	L Max. L 最大	D Max. D 最大	d ± 0.05	P +1 -3	H ± 1	E ± 0.5
1W (2W-S)	12	5.0	0.70	8	6	2.5
2W (3W-S)	16	5.5	0.70	8	6	2.5

M Forming Type (M 型)



Power Rating 功率 70°C	L(Max)	D(Max)	d ± 0.05	H ± 2	P ± 1.5
1/2W & 1WS	10	4	0.70	14	13
1W & 2WS	12	5	0.70	14	15
2W & 3W-S	16	5.5	0.70	18	20
3W & 5WS	17.5	6.5	0.75	20	25
5W	26	8.5	0.75	20	31

T Forming Type (T 型)

Power Rating 功率 70°C	L(Max)	D(Max)	d ± 0.05	P(Max)	H +1 -0
1W-S	10	3.5	0.70	12.5	8
1W(2W-S)	12	5.0	0.70	15	8
2W(3W-S)	16	5.5	0.70	20	9

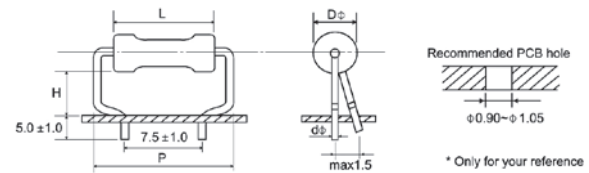

Ordering Procedure (Example: MOR1WS 5% 10Ω B/B M Type with flattened lead wire)

订购方式 (例如: MOR1WS 5% 10Ω B/B M 型导线打扁)

M O R 0 1 S J 0 1 0 0 B M F

<p>Special Feature (特征): O=Standard(标准品) I=Non-Inductive(无感型)</p>	<p>Wattage (功率): W2=1/2W 1W=1W 2W=2W 3W=3W 5W=5W 1S=1W-S 2S=2W-S 3S=3W-S 5W=5W-S</p>	<p>Tolerance (公差): G=2% J=±5% K=±10%</p>	<p>Packing Type (包装类型): B=Bulk/Box (散装 / 盒装)</p>	<p>Additional Information (注): F0=F Type (F 型) F1=F1 Type (F1 型) F2=F2Type (F2 型) F3=F3 Type (F3 型) T0=T Type (T 型) MF=M Type with flattened lead wire M 型导线打扁 MC=M Type with bending lead wire M 型导线打弯曲 MK=M Type with kinked lead wire M 型导线打弯折 ML=M Type with normal lead wire M 型导线直线</p>
<p>Product Type (产品类型): MOR=Metal Oxide Film Fixed Resistors (金属氧化膜固定电阻器) CFR=Carbon Film Fixed Resistors (碳膜固定电阻器)</p>				
<p>Resistance Value (阻值): 5% & 10% (E-24 series): the 1st digit is "0"; the 2nd & 3rd digits are for the significant figures of the resistance and the 4th indicate the numbers of zeros following; 5%,10% 产品 (E-24 系列阻值): 第 1 位是 0, 第 2、3 位表示阻值的有效数, 第 4 位表示有几个 0. 2% (E-96 series): the 1st to 3rd digits are for the significant figures of the resistance and the 4th indicate the numbers of zeros following. 2% 产品 (E-96 系列阻值): 第 1~3 位表示阻值的有效数, 第 4 位表示有几个 0.</p>				

Feature (特性)

- Used for insulation protection and fusing protection of wire-wound (fusible) resistor.
用于涂装产品的绝缘防护及绕线（保险丝）电阻的熔断防护。
- This specification is applicable for KNP、KNPU product only. For the other products (size), please consult factory for the available specification and drawing.
适用于 KNP、KNPU 的产品，其他产品请洽工厂取得可生产的规格图样。



TZ Forming Type (TZ 轴向套管)

TZ-1 Wrapped resistor body only
TZ-1 套管包电阻本体



TZ-2 Wrapped resistor body and lead one side only
TZ-2 套管包电阻本体及一边导线



TZ-3 Wrapped resistor body and lead both two side
TZ-3 套管包电阻本体及两边导线



Dimension (尺寸) (mm)

Type 类型	Forming type 加工形态	Dimension (尺寸) (mm) (L1、L2、L3 Adjustable range 可调范围)							
		D±1	L±1	L1	L2	L3	Ød±0.05	A (Max.)	C (Max.)
1/4W、1/2W、1WSS	TZ-1			38	25	/		/	
	TZ-2	2.5	6.5	38	2Min.	40Max.	0.54	/	Max.68mm
	TZ-3			2Min.	2Min.	40Max.		33	
1/2W、1WS、2WSS	TZ-1			38	25	/		/	
	TZ-2	3.5	9.5	38	2Min.	40Max.	0.54	/	Max.71mm
	TZ-3			2Min.	2Min.	40Max.		30	
1W、2WS、3WSS	TZ-1			38	25	/		/	
	TZ-2	4.5	11.5	38	2Min.	40Max.	0.70	/	Max.73mm
	TZ-3			2Min.	2Min.	40Max.		28	
2W、3WS、4WSS	TZ-1			38	25	/		/	
	TZ-2	5.5	15.5	38	2Min.	40Max.	0.70	/	Max.77mm
	TZ-3			2Min.	2Min.	40Max.		25	



Feature (特性)

- Made by Cu/Ni or Mn/Cu Alloy resistance wire materials
由铜 / 镍或锰 / 铜合金电阻线制成
- Excellent Solderability 优越的焊接性能
- Suitable for all kinds of Current sense application
适用于各种类型的电流感应器应用
- Application: Power Supply 电源供应

CSRA Type- CSRA 型



CSRB Type- CSRB 型



CSRC Type- CSRC 型



CSRD Type- CSRD 型



CSRE Type- CSRE 型

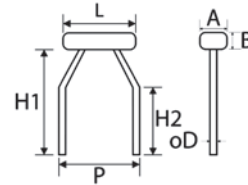

Specification(性能)

Type 类型	ØD 线径	Rated Current 额定电流	Resistance Range 阻值范围	TCR	Remark 备注
CSRA CSRB CSRC CSRD	Ø0.8mm	4.5A	5mΩ~50mΩ	±100PPM/°C	*P&H could be design by customer's requirement P 值和 H 值可根据客户的要求进行设计 *Temperature coefficient of resistor could be design by customer's requirement 温度系数可根据客户的要求进行设计
	Ø0.9mm	5.0A	5mΩ~40mΩ		
	Ø1.0mm	5.5A	3mΩ~30mΩ		
	Ø1.1mm	6.0A	3mΩ~20mΩ		
	Ø1.2mm	7.0A	3mΩ~20mΩ		
	Ø1.3mm	7.5A	3mΩ~20mΩ		
	Ø1.4mm	8.0A	3mΩ~20mΩ		
	Ø1.5mm	9.0A	3mΩ~20mΩ		
	Ø1.6mm	9.5A	3mΩ~15mΩ		
	Ø1.8mm	11A	3mΩ~10mΩ		
CSRE	Ø2.0mm	12A	3mΩ~10mΩ		
	Ø2.3mm	14A	3mΩ~7mΩ		
	Ø1.0mm	50A	1mΩ		

Feature (特性)

- Made by Cu/Ni or Mn/Cu Alloy resistance wire materials
由铜 / 镍或锰 / 铜合金电阻线制成
- Excellent Solderability 优越的焊接性能
- Suitable for all kinds of Current sense application
适用于各种类型的电流感应器应用
- Application: Power Supply 电源供应



CSSA Type- CSSA 型



CSSB Type- CSSB 型

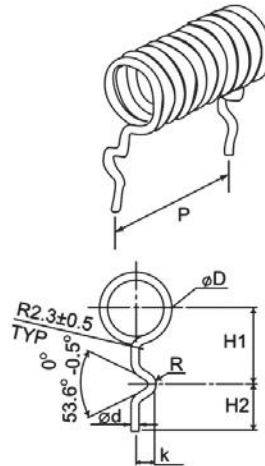

CSSC Type- CSSC 型

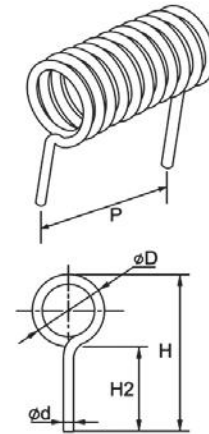

Type 类型	ØD 线径	Rated Current 额定电流	Resistance Range 阻值范围	Remark 备注
	Ø0.8mm	4.5A	5mΩ~50mΩ	
CSSA	Ø1.0mm	5.5A	3mΩ~30mΩ	*P&H could be design by customer's requirement
CSSB	Ø1.6mm	9.5A	3mΩ~15mΩ	*P 值和 H 值可根据客户的要求进行设计
CSSC	Ø2.0mm	12A	3mΩ~10mΩ	

Ordering Procedure (Example: CSRC Ø1.5mm 10mΩ±5% B/B)

订购方式 (例如: CSRC Ø1.5mm 10mΩ±5% B/B)



Remark: Please refer to page 141 for ordering guide. 注: 下单请详见 P141 页说明。

Tape in Box Packing (Ammo Pack) (编带盒装)

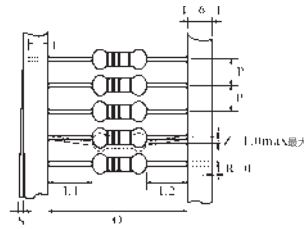

*L1-L2=1.0 Max. 最大
ZW: 0
**S=0.5 Max. 最大
PT-26: 0.8 Max. 最大

Part No 料号	Type 类型	Dimension of T/B(尺寸) (mm)					Qty./Box 数量 / 盒
		O	P	A±5	B±5	C±5	
Carbon Film Fixed Resistors(碳膜固定电阻器)							
CFR0W8	CFR-12	52±1	5±0.3	75	70	255	5,000
CFR0S4	CFR-25-S	52±1	5±0.3	75	70	255	5,000
CFR0W4	CFR-25	52±1	5±0.3	75	98	255	5,000
CFR0W2	CFR-50	52±1	5±0.3	75	45	255	1,000
CFR01S	CFR-100-S	52±1	5±0.3	86	82	255	1,000
CFR01W	CFR-100	64±5	10±0.5	94	88	255	1,000
CFR02S	CFR-200-S	64±5	10±0.5	94	88	255	1,000
CFR02W	CFR-200	64±5	10±0.5	90	88	255	500
CFR03S	CFR-300-S	64±5	10±0.5	90	88	255	500
CPR0W2	CPR-50	52±1	5±0.3	75	116	255	5,000
CPR01W	CPR-100	52±1	5±0.3	75	45	255	1,000
CPR02W	CPR-200	52±1	5±0.3	86	82	255	1,000
Precision Metal Film Lilm Fixed Resistors (金属膜固定电阻器)							
MF0W8	MF-12	52±1	5±0.3	75	70	255	5,000
MF0S4	MF-25-S	52±1	5±0.3	75	70	255	5,000
MF004	MF-40-SS	52±1	5±0.3	75	70	255	5,000
MF0W4	MF-25	52±1	5±0.3	75	98	255	5,000
MF0S2	MF-50-S	52±1	5±0.3	75	98	255	5,000
MF006	MF-60-S	52±1	5±0.3	75	98	255	5,000
MF0W2	MF-50	52±1	5±0.3	75	45	255	1,000
MF01S	MF-100-S	52±1	5±0.3	75	45	255	1,000
MF01W	MF-100	52±1	5±0.3	86	82	255	1,000
MF02S	MF-200-S	52±1	5±0.3	86	82	255	1,000
MF02W	MF-200	64±5	10±0.5	94	88	255	1,000
MF03S	MF-300-S	64±5	10±0.5	94	88	255	1,000
MF03W	MF-300	64±5	10±0.5	90	88	255	500
Metal Film Power Resistors (高功率金属膜电阻器)							
PMR01S	PMR-100-S	52±1	5±0.3	75	98	255	5,000
PMR02S	PMR-200-S	52±1	5±0.3	86	82	255	1,000
PMR03S	PMR-300-S	64±5	10±0.5	90	88	255	1,000

Note: The above is recommended packaging, the actual packing method is in accordance with the order.

注: 以上为推荐包装方式, 实际以工厂依订单情形的包装方式为准

Tape in Box Packing (Ammo Pack) (编带盒装)



*L1-L2=1.0 Max. 最大
ZW: 0
**S=0.5 Max. 最大
PT-26: 0.8 Max. 最大

Part No 料号	Type 类型	Dimension of T/B(尺寸) (mm)					Qty./Box 数量 / 盒
		O	P	A±5	B±5	C±5	
Metal Oxide Film Fixed Resistors (金属氧化膜固定电阻器)							
MOR0W4	MOR-25	52±1	5±0.3	75	116	255	5,000
MOR0S2	MOR-50-S	52±1	5±0.3	75	116	255	5,000
MOR0W2	MOR-50	52±1	5±0.3	75	45	255	1,000
MOR01S	MOR-100-S	52±1	5±0.3	75	70	255	1,000
MOR01W	MOR-100	52±1	5±0.3	86	82	255	1,000
MOR02S	MOR-200-S	52±1	5±0.3	86	82	255	1,000
MOR02W	MOR-200	64±5	10±0.5	90	119	255	1,000
MOR03S	MOR-300-S	64±5	10±0.5	90	119	255	1,000
MOR03W	MOR-300	64±5	10±0.5	90	88	255	500
MOR05S	MOR-500-S	64±5	10±0.5	90	88	255	500
MOR05W	MOR-500	90±5	10±0.5	115	124	500	500
Metal Glaze Film Fixed Resistors (精密玻璃釉膜固定电阻器)							
MGR0W4	MGR-25	52±1	5±0.3	75	116	255	4,000
MGR0W2	MGR-50	52±1	5±0.3	75	70	255	1,000
MGR01W	MGR-100	52±1	5±0.3	86	82	255	1,000
MGR02W	MGR-200	64±5	10±0.5	90	119	255	1,000
MGR03W	MGR-300	64±5	10±0.5	90	88	255	500
MGR0S2	MGR-50-S	52±1	5±0.3	75	116	255	4,000
MGR01S	MGR-100-S	52±1	5±0.3	75	70	255	1,000
MGR02S	MGR-200-S	52±1	5±0.3	86	82	255	1,000
MGR03U	MGR-300-SS	52±1	5±0.3	86	82	255	1,000
MGR03S	MGR-300-S	64±5	10±0.5	90	119	255	1,000
Fusible Resistors(保险丝电阻器)							
FRN0W4	FRN-25	52±1	5±0.3	75	116	255	5,000
FRN0S2	FRN-50-S	52±1	5±0.3	75	116	255	5,000
FRN004	FRN-40	52±1	5±0.3	75	116	255	5,000
FRN0W2	FRN-50	52±1	5±0.3	75	45	255	1,000
FRN075	FRN-75	52±1	5±0.3	80	70	255	1,000
FRN01W	FRN-100	52±1	5±0.3	80	70	255	1,000
FRN01A	FRN-150	52±1	5±0.3	86	82	255	1,000
FRN02W	FRN-200	52±1	5±0.3	86	82	255	1,000
FRN03W	FRN-300	64±5	10±0.5	90	119	255	1,000

Note: The above is recommended packaging, the actual packing method is in accordance with the order.
以上为推荐包装方式，实际以工厂依订单情形的包装方式为准

Tape in Box Packing (Ammo Pack) (编带盒装)



*L1-L2=1.0 Max. 最大
ZW: 0
**S=0.5 Max. 最大
PT-26: 0.8 Max. 最大

Part No 料号	Type 类型	Dimension of T/B(尺寸) (mm)					Qty./Box 数量 / 盒
		O	P	A±5	B±5	C±5	
Wire Wound Fixed Resistors KNP (with Non-inductive KNPN & Anti-surge KNPA) 绕线固定器 (含无感型 KNPN 与耐脉冲型 KNPA)							
KNP*W4	KNP*-25	52±1	5±0.3	75	116	255	5,000
KNP*S2	KNP*-50-S	52±1	5±0.3	75	116	255	5,000
KNP*W2	KNP*-50	52±1	5±0.3	75	45	255	1,000
KNP*1S	KNP*-100-S	52±1	5±0.3	75	45	255	1,000
KNP*1W	KNP*-100	52±1	5±0.3	86	82	255	1,000
KNP*2S	KNP*-200-S	52±1	5±0.3	86	82	255	1,000
KNP*2W	KNP*-200	64±5	10±0.5	90	119	255	1,000
KNP*3S	KNP*-300-S	64±5	10±0.5	90	119	255	1,000
KNP*3W	KNP*-300	64±5	10±0.5	90	88	255	500
KNP*5S	KNP*-500-S	64±5	10±0.5	90	88	255	500
KNP*5W	KNP*-500	90±5	10±0.5	115	124	500	500
KNP*7S	KNP*-700-S	90±5	10±0.5	115	124	500	500
Jumper Wires & Zero Ohm Resistors(跳线和零欧姆固定电阻器)							
ZWA0	ZW-A	52±1	5±0.3	75	98	255	10,000
ZWB0	ZW-B	52±1	5±0.3	75	116	255	10,000
ZWB-1	ZW-B1	52±1	5±0.3	75	116	255	10,000
ZWC0	ZW-C	52±1	5±0.3	75	116	255	8,000
ZWD0	ZW-D	52±1	5±0.3	75	116	255	8,000
ZWE0	ZW-E	52±1	5±0.3	75	116	255	7,000
ZOT0W8 ZOC0W8	ZOT-12 ZOC-12	52±1	5±0.3	75	70	255	5,000
ZOT0W4 ZOC0W4	ZOT-25 ZOC-25	52±1	5±0.3	75	98	255	5,000
PT-26Type (PT-26 类型)							
CFR0W8 MF0W8	CFR-12 MF-12	26 ^{+1.5} _{-1.0}	5±0.5	50	66	255	5,000
CFR0S4 MF0S4	CFR-25-S MF-25-S	26 ^{+1.5} _{-1.0}	5±0.5	50	66	255	5,000
MF004	MF-40-SS	26 ^{+1.5} _{-1.0}	5±0.5	50	66	255	5,000
CFR0W4 MF0W4 FRN0W4	CFR-25 MF-25 FRN-25	26 ^{+1.5} ₋₀	5±0.5	50	100	255	5,000
MF0S2 MOR0S2	MF-50-S MOR-50-S	26 ^{+1.5} ₋₀	5±0.5	50	100	255	5,000
MF006	MF-60-S	26 ^{+1.5} ₋₀	5±0.5	50	100	255	5,000

Note: The above is recommended packaging, the actual packing method is in accordance with the order.
以上为推荐包装方式, 实际以工厂依订单情形的包装方式为准

Tape in Reel (编带卷装)



Part No 料号	Type 类型	Dimension of T/R(尺寸) (mm)					Qty./Box 数量 / 盒
		O	A	W±5	H±5	L±5	
Carbon Film Fixed Resistors(碳膜固定电阻器)							
CFR0W8	CFR-12	52±1	73±2	85	295	293	5,000
CFR0S4	CFR-25-S	52±1	73±2	85	295	293	5,000
CFR0W4	CFR-25	52±1	73±2	85	295	293	5,000
CFR0W2	CFR-50	52±1	73±2	85	295	293	2,500
CFR01S	CFR-100-S	52±1	73±2	85	295	293	2,500
CFR01W	CFR-100	64±5	80±5	95	295	293	1,000
CFR02S	CFR-200-S	64±5	80±5	95	295	293	1,000
CFR02W	CFR-200	64±5	80±5	95	295	293	1,000
CFR03S	CFR-300-S	64±5	80±5	95	295	293	1,000
CPR0W2	CPR-50	52±1	73±2	85	295	293	5,000
CPR01W	CPR-100	52±1	73±2	85	295	293	2,500
CPR02W	CPR-200	52±1	73±2	85	295	293	2,500
Precision Metal Film Fixed Resistors (金属膜固定电阻器)							
MF0W8	MF-12	52±1	73±2	85	295	293	5,000
MF0S4	MF-25-S	52±1	73±2	85	295	293	5,000
MF004	MF-40-SS	52±1	73±2	85	295	293	5,000
MF0W4	MF-25	52±1	73±2	85	295	293	5,000
MF0S2	MF-50-S	52±1	73±2	85	295	293	5,000
MF0W2	MF-50	52±1	73±2	85	295	293	2,500
MF006	MF-60-S	52±1	73±2	85	295	293	5,000
MF01S	MF-100-S	52±1	73±2	85	295	293	2,500
MF01W	MF-100	52±1	73±2	85	295	293	2,500
MF02S	MF-200-S	52±1	73±2	85	295	293	2,500
MF02W	MF-200	64±5	80±5	95	295	293	1,000
MF03S	MF-300-S	64±5	80±5	95	295	293	1,000
MF03W	MF-300	64±5	80±5	95	295	293	1,000
Metal Film Power Resistors (高功率金属膜电阻器)							
PMR01S	PMR-100-S	52±1	73±2	85	295	293	5,000
PMR02S	PMR-200-S	52±1	73±2	85	295	293	2,500
PMR03S	PMR-300-S	64±5	80±5	95	295	293	1,000

Note: The above is recommended packaging, the actual packing method is in accordance with the order.
以上为推荐包装方式，实际以工厂依订单情形的包装方式为准

Tape in Reel (编带卷装)



Part No 料号	Type 类型	Dimension of T/R (尺寸) (mm)					Qty./Box 数量 / 盒
		O	A	W±5	H±5	L±5	
Metal Oxide Film Fixed Resistors (金属氧化膜固定电阻器)							
MOR0W4	MOR-25	52±1	73±2	85	295	293	5,000
MOR0S2	MOR-50-S	52±1	73±2	85	295	293	5,000
MOR0W2	MOR-50	52±1	73±2	85	295	293	2,500
MOR01S	MOR-100-S	52±1	73±2	85	295	293	2,500
MOR01W	MOR-100	52±1	73±2	85	295	293	2,500
MOR02S	MOR-200-S	52±1	73±2	85	295	293	2,500
MOR02W	MOR-200	64±5	80±5	95	295	293	1,000
MOR03S	MOR-300-S	64±5	80±5	95	295	293	1,000
MOR03W	MOR-300	64±5	80±5	95	295	293	1,000
MOR05S	MOR-500-S	64±5	80±5	95	295	293	1,000
MOR05W	MOR-500	90±5	115±5	121	310	310	700
Metal Glaze Film Fixed Resistors (精密玻璃釉膜固定电阻器)							
MGR0W4	MGR-25	52±1	73±2	85	295	293	5,000
MGR0W2	MGR-50	52±1	73±2	85	295	293	2,500
MGR01W	MGR-100	52±1	73±2	85	295	293	1,000
MGR02W	MGR-200	64±5	80±5	95	295	293	1,000
MGR03W	MGR-300	64±5	80±5	95	295	293	1,000
MGR0S2	MGR-50-S	52±1	73±2	85	295	293	5,000
MGR01S	MGR-100-S	52±1	73±2	85	295	293	2,500
MGR02S	MGR-200-S	52±1	73±2	85	295	293	1,000
MGR03U	MGR-300-SS	52±1	73±2	85	295	293	1,000
MGR03S	MGR-300-S	64±5	80±5	95	295	293	1,000
Fusible Resistors(保险丝电阻器)							
FRN0W4	FRN-25	52±1	73±2	85	295	293	5,000
FRN0S2	FRN-50-S	52±1	73±2	85	295	293	5,000
FRN004	FRN-40	52±1	73±2	85	295	293	5,000
FRN0W2	FRN-50	52±1	73±2	85	295	293	2,500
FRN075	FRN-75	52±1	73±2	85	295	293	2,500
FRN01W	FRN-100	52±1	73±2	85	295	293	2,500
FRN01A	FRN-150	52±1	73±2	85	295	293	2,500
FRN02W	FRN-200	52±1	73±2	85	295	293	2,500
FRN03W	FRN-300	64±5	80±5	95	295	293	1,000

Note: The above is recommended packaging, the actual packing method is in accordance with the order.
以上为推荐包装方式, 实际以工厂依订单情形的包装方式为准

Tape in Reel (编带卷装)

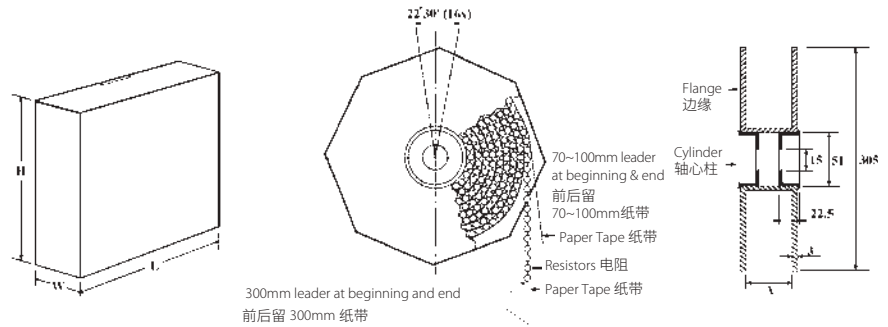

Part No 料号	Type 类型	Dimension of T/R (尺寸) (mm)					Qty./Box 数量 / 盒
		O	A	W±5	H±5	L±5	
Wire Wound Fixed Resistors KNP (with Non-inductive KNPN & Anti-surge KNPA) 绕线固定器 (含无感型 KNPN 与耐脉冲型 KNPA)							
KNP*W4	KNP*-25	52±1	73±2	85	295	293	5,000
KNP*S2	KNP*-50-S	52±1	73±2	85	295	293	5,000
KNP*W2	KNP*-50	52±1	73±2	85	295	293	2,500
KNP*1S	KNP*-100-S	52±1	73±2	85	295	293	2,500
KNP*1W	KNP*-100	52±1	73±2	85	295	293	2,500
KNP*2S	KNP*-200-S	52±1	73±2	85	295	293	2,500
KNP*2W	KNP*-200	64±5	80±5	95	295	293	1,000
KNP*3S	KNP*-300-S	64±5	80±5	95	295	293	1,000
KNP*3W	KNP*-300	64±5	80±5	95	295	293	1,000
KNP*5S	KNP*-500-S	64±5	80±5	95	295	293	1,000
KNP*5W	KNP*-500	90±5	115±5	121	310	310	700
KNP*7S	KNP*-700-S	90±5	115±5	121	310	310	700
Jumper Wires & Zero Ohm Resistors(跳线和零欧姆固定电阻器)							
ZWA0	ZW-A	52±1	73±2	85	295	293	10,000
ZWB0	ZW-B	52±1	73±2	85	295	293	10,000
ZWB-1	ZW-B1	52±1	73±2	85	295	293	10,000
ZWC0	ZW-C	52±1	73±2	85	295	293	10,000
ZWD0	ZW-D	52±1	73±2	85	295	293	10,000
ZWE0	ZW-E	52±1	73±2	85	295	293	10,000
ZOT0W8 ZOC0W8	ZO-12	52±1	73±2	85	295	293	5,000
ZOT0W4 ZOC0W4	ZO-25	52±1	73±2	85	295	293	5,000

Note: The above is recommended packaging, the actual packing method is in accordance with the order.
以上为推荐包装方式，实际以工厂依订单情形的包装方式为准

Bulk in Box Packing (散装盒装)



Part No 料号	Type 类型	Dimension of B/B(尺寸) (mm)			Qty.of Bag/Box 袋数量 / 盒数量
		A±5	B±5	C±5	
Carbon Film Fixed Resistors(碳膜固定电阻器)					
CFR0W8	CFR-12	140	80	240	1,000/20,000
CFR0S4	CFR-25-S	140	80	240	1,000/20,000
CFR0W4	CFR-25	140	80	240	500/10,000
CFR0W2	CFR-50	140	80	240	250/5,000
CFR01S	CFR-100-S	140	80	240	100/2,500
CFR01W	CFR-100	140	80	240	100/1,500
CFR02S	CFR-200-S	140	80	240	100/1,500
CFR02W	CFR-200	140	80	240	100/1,000
CFR03S	CFR-300-S	140	80	240	100/1,000
CPR0W2	CPR-50	140	80	240	500/10,000
CPR01W	CPR-100	140	80	240	250/5,000
CPR02W	CPR-200	140	80	240	100/2,500
Precision Metal Film Fixed Resistors (金属膜固定电阻器)					
MF0W8	MF-12	140	80	240	1,000/20,000
MF0S4	MF-25-S	140	80	240	1,000/20,000
MF004	MF-40-SS	140	80	240	1,000/20,000
MF0W4	MF-25	140	80	240	500/10,000
MF0S2	MF-50-S	140	80	240	500/10,000
MF0W2	MF-50	140	80	240	250/5,000
MF006	MF-60-S	140	80	240	500/10,000
MF01S	MF-100-S	140	80	240	250/5,000
MF01W	MF-100	140	80	240	100/2,500
MF02S	MF-200-S	140	80	240	100/2,500
MF02W	MF-200	140	80	240	100/1,500
MF03S	MF-300-S	140	80	240	100/1,500
MF03W	MF-300	140	80	240	100/1,500
Metal Film Power Resistors (高功率金属膜电阻器)					
PMR01S	PMR-100-S	140	80	240	500/10,000
PMR02S	PMR-200-S	140	80	240	100/2,500
PMR03S	PMR-300-S	140	80	240	100/1,500

Note: The above is recommended packaging, the actual packing method is in accordance with the order.
以上为推荐包装方式，实际以工厂依订单情形的包装方式为准

Bulk in Box Packing (散装盒装)



Part No 料号	Type 类型	Dimension of B/B(尺寸) (mm)			Qty.of Bag/Box 袋数量 / 盒数量
		A±5	B±5	C±5	
Metal Oxide Film Fixed Resistors (金属氧化膜固定电阻器)					
MOR0W4	MOR-25	140	80	240	500/10,000
MOR0S2	MOR-50-S	140	80	240	500/10,000
MOR0W2	MOR-50	140	80	240	250/5,000
MOR01S	MOR-100-S	140	80	240	250/5,000
MOR01W	MOR-100	140	80	240	100/2,500
MOR02S	MOR-200-S	140	80	240	100/2,500
MOR02W	MOR-200	140	80	240	100/1,500
MOR03S	MOR-300-S	140	80	240	100/1,500
MOR03W	MOR-300	140	80	240	100/1,000
MOR05S	MOR-500-S	140	80	240	100/1,000
MOR05W	MOR-500	140	80	240	25/400
MOR07W	MOR-700	140	80	240	25/300
MOR08W	MOR-800	140	80	240	25/200
MOR09W	MOR-900	140	80	240	25/200
Metal Glaze Film Fixed Resistors (精密玻璃釉膜固定电阻器)					
MGR0W4	MGR-25	140	80	240	500/10,000
MGR0W2	MGR-50	140	80	240	250/5,000
MGR01W	MGR-100	140	80	240	100/2,500
MGR02W	MGR-200	140	80	240	100/1,500
MGR03W	MGR-300	140	80	240	100/1,000
MGR0S2	MGR-50-S	140	80	240	500/10,000
MGR01S	MGR-100-S	140	80	240	250/5,000
MGR02S	MGR-200-S	140	80	240	100/2,500
MGR03U	MGR-300-SS	140	80	240	100/2,500
MGR03S	MGR-300-S	140	80	240	100/1,500

Note: The above is recommended packaging, the actual packing method is in accordance with the order.
以上为推荐包装方式，实际以工厂依订单情形的包装方式为准

Bulk in Box Packing (散装盒装)



Part No 料号	Type 类型	Dimension of B/B(尺寸) (mm)			Qty.of Bag/Box 袋数量 / 盒数量
		A±5	B±5	C±5	
Fusible Resistors(保险丝电阻器)					
FRN0W4	FRN-25	140	80	240	500/10,000
FRN0S2	FRN-50-S	140	80	240	500/10,000
FRN004	FRN-40	140	80	240	500/10,000
FRN0W2	FRN-50	140	80	240	250/5,000
FRN075	FRN-75	140	80	240	250/5,000
FRN01W	FRN-100	140	80	240	250/5,000
FRN01A	FRN-150	140	80	240	100/2,500
FRN02W	FRN-200	140	80	240	100/2,500
FRN03W	FRN-300	140	80	240	100/1,500
Wire Wound Fixed Resistors KNP (with Non-inductive KNPN & Anti-surge KNPA) 绕线固定器 (含无感型 KNPN 与耐脉冲型 KNPA)					
KNP*W4	KNP*-25	140	80	240	500/10,000
KNP*S2	KNP*-50-S	140	80	240	500/10,000
KNP*W2	KNP*-50	140	80	240	250/5,000
KNP*1S	KNP*-100-S	140	80	240	250/5,000
KNP*1W	KNP*-100	140	80	240	100/2,500
KNP02S	KNP*-200-S	140	80	240	100/2,500
KNP*2W	KNP*-200	140	80	240	100/1,500
KNP*3S	KNP*-300-S	140	80	240	100/1,500
KNP*3W	KNP*-300	140	80	240	100/1,000
KNP*5S	KNP*-500-S	140	80	240	100/1,000
KNP*5W	KNP*-500	140	80	240	25/400
KNP*7S	KNP*-700-S	140	80	240	25/400
KNP*7W	KNP*-700	140	80	240	25/300
KNP*8S	KNP*-800-S	140	80	240	25/300
KNP*8W	KNP*-800	140	80	240	25/200
KNP*9S	KNP*-900-S	140	80	240	25/200
KNP*9W	KNP*-900	140	80	240	25/200
KNP*AS	KNP*-1000-S	140	80	240	25/200
Zero Ohm Resistors(零欧姆固定电阻器)					
ZOT0W8 ZOC0W8	ZO-12	140	80	240	1,000/20,000
ZOT0W4 ZOC0W4	ZO-25	140	80	240	500/10,000

Note: The above is recommended packaging, the actual packing method is in accordance with the order.
以上为推荐包装方式，实际以工厂依订单情形的包装方式为准

Feature (特性)

- Miniature, high density packaging
小型高密度封装
- High reliability $R_{10}O_2$ paste
使用高稳定性 $R_{10}O_2$ 电阻材料

Application (应用)

- Control circuit V.C.R. (V.C.R.控制电路)
- Air-conditioner (空调)
- Computer, color TV (计算机, 彩电)
- Facsimile (传真机)



Dimension (尺寸) (mm)



● indicate the 1st pin (表示第一脚位置)

Derating Curve (降功率曲线)



Type 类型	Dimension of L(Max.) L 的最大尺寸											H max	C +0.5 -0.3	T max	t±0.05	P±0.2	D±0.1
	4pin	5pin	6pin	7pin	8pin	9pin	10 pin	11 pin	12 pin	13 pin	14 pin						
RNL	10.2	12.7	15.3	17.8	20.4	22.9	25.4	28.0	30.5	33.1	35.6	5.08	3.3	2.5	0.25	2.54	0.5
RPL	10.2	12.7	15.3	17.8	20.4	22.9	25.4	28.0	30.5	33.1	35.6	5.08	3.3	2.5	0.25	2.54	0.5
RNM	10.2	12.7	15.3	17.8	20.4	22.9	25.4	28.0	30.5	33.1	35.6	6.35	3.3	2.5	0.25	2.54	0.5
RPH	10.2	12.7	15.3	17.8	20.4	22.9	25.4	28.0	30.5	33.1	35.6	8.89	3.3	2.5	0.25	2.54	0.5

Circuit Structure (电路结构)



* Custom Design Circuit could be available on a case to case basis. (可按客户特殊要求定制)

Package Power Ratings (封装功率等级)

Type 类型	4PIN	5PIN	6PIN	7PIN	8PIN	9PIN	10PIN	11PIN	12PIN	13PIN	14PIN
RPL	0.5W	0.63W	0.75W	0.88W	1.0W	1.13W	1.25W	1.38W	1.5W	1.63W	1.75W
RNM	0.6W	0.75W	0.9W	1.05W	1.20W	1.35W	1.50W	1.65W	1.80W	1.95W	2.10W
RPH	0.8W	1.0W	1.2W	1.4W	1.6W	1.8W	2.0W	2.2W	2.4W	2.6W	2.8W

Type 类型	Power Rating (功率) 70°C	Max. Working Voltage 最大工作电压	Max. Overload Voltage 最大过负荷电压	Dielectric Withstanding Voltage 绝缘耐压	Resistance Range 阻值范围	Tolerance 公差	Operating Temperature 工作温度范围
RNL	B type(B 型): 0.2W	100V	150V	200V	R Type(R 型): 100Ω~10K	±2% ±5%	-55°C~+155°C
	Others(其它类型): 0.125W				Others(其它类型): 10Ω~1MΩ		
RPL	A:0.2W	100V	150V	200V	10Ω~1MΩ	±2% ±5%	-55°C~+155°C
	B:0.3W				10Ω~1MΩ		
	R:0.2W				100Ω~10KΩ		
RNM	A:0.25W	100V	150V	200V	10Ω~1MΩ	±2% ±5%	-55°C~+155°C
	B:0.4W				10Ω~1MΩ		
	R:0.25W				100Ω~10KΩ		
RPH	A:0.3W	100V	150V	200V	10Ω~1MΩ	±2% ±5%	-55°C~+155°C
	B:0.5W				10Ω~1MΩ		
	R:0.3W				100Ω~10KΩ		

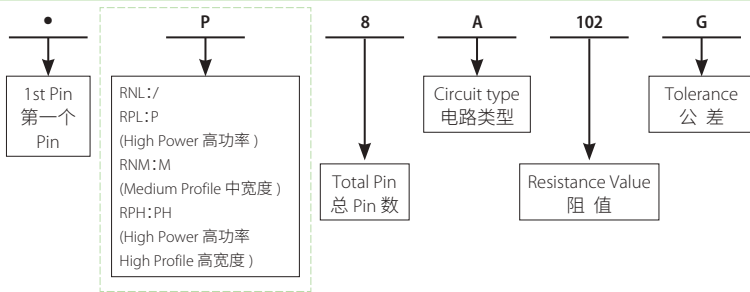
Marking (Single Value) [标示(单个阻值)]:

Marking(Dual Value)[标示(双阻类型)]:

Dual Value (双阻型阻值系列)(R1/R2)(Ohm)

160 / 240	330 / 390
180 / 390	330 / 470
220 / 270	1.5K / 3.5K
220 / 330	3.0K / 6.2K

* Special Value available on a case to case basis. (另可按客户特殊要求订做)

Performance Specification(性能)

Test Item 试验项目		Evaluation Criteria 判定标准			
		RNL	RPL	RNM	RPH
Temperature	温度系数	50Ω~1MΩ: ±200PPM/°C <50Ω&>1MΩ: ±250PPM/°C		50Ω~1MΩ: ±100PPM/°C <50Ω&>1MΩ: ±250PPM/°C	
Short-time overload	短时间过负荷	ΔR/R≤±(0.5%+0.1Ω)		ΔR/R≤±(0.25%+0.1Ω)	
Insulation resistance	绝缘电阻	≥10,000MΩ			
Dielectric withstanding voltage	绝缘耐压	No Evidence of flashover,arcing or insulation breakdown(无击穿、飞弧及可见机械损伤)			
Terminal strength	端子强度	ΔR/R≤±(0.5%+0.1Ω)		ΔR/R≤±(0.25%+0.1Ω)	
Soldering heat	耐焊接热	ΔR/R≤±(0.5%+0.1Ω)			
Solderability	可焊性	Coverage must be over 95%.			
Thermal shock	热冲击	ΔR/R≤±(0.5%+0.1Ω)		ΔR/R≤±(0.25%+0.1Ω)	
Rapid change of temperature	温度快速变化	ΔR/R≤±(0.5%+0.1Ω)			
Load life in humidity	湿度寿命	ΔR/R≤±(3%+0.1Ω)		ΔR/R≤±(0.5%+0.1Ω)	
Load life	负载寿命	ΔR/R≤±(3%+0.1Ω)		ΔR/R≤±(1%+0.1Ω)	

Ordering Procedure (Example: RNL A type 10 PIN 2% 10KΩ B/B)

订购方式 (例如: RNL A 型 10 PIN 2% 10KΩ B/B)



Standard Packing of Resistor Network (网络电阻器的标准包装)



Type 类型	Pins 引脚数	Weight of 1,000pcs 1,000只重量 (g)	Qty.per Bag 每袋数量	Qty.per Box 每盒数量	Qty.per Carton 每箱数量	Type 类型	Pins 引脚数	Weight of 1,000pcs 1,000只重量 (g)	Qty.per Bag 每袋数量	Qty.per Box 每盒数量	Qty.per Carton 每箱数量
RNL RPL	4	210	200	1,000	30,000	RNL RPL	10	530	200	1,000	30,000
RNM		240	100			RNM		610	50	500	15,000
RPH		330	100			RPH		870	50	500	15,000
RNL RPL	5	250	200	1,000	30,000	RNL RPL	11	600	100	500	15,000
RNM		300	100			RNM		670	50		
RPH		410	100			RPH		950	50		
RNL RPL	6	320	200	1,000	30,000	RNL RPL	12	650	100	500	15,000
RNM		360	100			RNM		730	50		
RPH		490	100			RPH		1030	50		
RNL RPL	7	360	200	1,000	30,000	RNL RPL	13	710	100	500	15,000
RNM		420	100			RNM		790	50		
RPH		570	100			RPH		1130	50		
RNL RPL	8	430	200	1,000	30,000	RNL RPL	14	770	100	500	15,000
RNM		480	100			RNM		850	50		
RPH		660	50			RPH		1210	50		
RNL RPL	9	450	200	1,000	30,000	RNL RPL	14	770	100	500	15,000
RNM		540	50			RNM		850	50		
RPH		760	50			RPH		1210	50		

Ammo Pack of Resistor Network (网络电阻器编带包装)



* ... n=Pin Count



Dimension 尺寸 (mm)		Dimension 尺寸 (mm)	
H1	Max 5.08	t0	2.0Max
L	Max 2.54*n	t1	18.99±0.5
a	2.54±0.25	t2	9.0±0.5
d1	0.5±0.1	t3	24.46Max
P	25.4±1.0	t4	1.5max
W	18±0.5	l	φ4.0±0.3
w	5.0min	h2	3.0±0.5
P1	6.35±0.7	a1	2.54±0.25
P2	12.7±0.3	a2	5.08±0.3
B	Max 2.49	d3	2.0Max
T	16±0.5	/	/

Packing quantity (包装数量)



The inner box sizes 内盒尺寸：
4~9pin: 320(L) × 207(W) × 40(H)mm
10pin: 315(L) × 295(W) × 40(H)mm

Pins 引脚数	Qty.per Box 每盒数量	Qty.per Carton 每箱数量
4~10	1,000	12,000

Special Network-SIP Series

特殊网络电阻器 SIP 系列



Type(类型)	SN0001	SN0002	SN0003	SN0004
Circuit Structure (电路结构)	 R1=500Ω ±5% R2=40K ±5% (TO: R3: ±1%) R3=10K ±5% R4=R5=75K ±5% R6=R7=100K ±5% (R8 TO R3: ±1%)	 R1=33KΩ ±5% R2=22KΩ ±5%	 R3=9K1 R1=120K R14=24K R4=30K R2=14K R15=1K5 R5=80=75K R10=R11=R12=20K R13=2K R7=52K5 R13=11K	 R1=520Ω R2=700Ω R3=121Ω R4=249Ω R5=1K33 R6=619K R7=174Ω R8=75Ω
Dimension of L(max) 尺寸 L(最大)	10PINS:25.4mm	10PINS:25.4mm	10PINS:43.2mm	9PINS:22.9mm
H(max) H(最大)	5.08mm	5.08mm	6.35mm	5.08mm
Power Rating at 70°C 功率 70°C	0.2W	0.2W	0.125W	0.125W
Max Working Voltage 最大工作电压	100V	100V	100V	100V
Max Overload Voltage 最大过负荷电压	150V	150V	200V	150V
Operating Temperature 工作温度	-55~+155 °C	-55~+155°C	-55~+155 °C	-55~+155 °C

* Custom Design Circuit could be available on a case to case basis (可提供客户特殊要求之线路产品)

Resistor/Capacitor Network - SIP Series

网络阻容器 - SIP 系列



Electrical Characteristics- Capacitor (电容特性)

Capacitance Dielectric 电容介质	Capacitance Range 电容范围	Capacitance Tolerance 电容公差	Capacitance Voltage 电容电压
NPO	39pF~270pF	±10%	50V
X7R	>270pF~0.1μF	±20%	

Dimension (尺寸) (mm):

Type 类型	H (mm)	F (mm)
RCH	7.62 Max.	3.81 Max.
RCN	8.89 Max.	3.81 Max.

Dimension (尺寸) (mm):

L	
4 PIN: 10.2mm	10 PIN: 25.4mm
5 PIN: 12.7mm	11 PIN: 28.0mm
6 PIN: 15.3mm	12 PIN: 30.5mm
7 PIN: 17.8mm	13 PIN: 33.1mm
8 PIN: 20.4mm	14 PIN: 35.6mm
9 PIN: 22.9mm	

* Custom Design Circuit could be available on a case to case basis (可提供客户特殊要求之线路产品)

Capacitor Network-SIP Series

网络电容器 SIP 系列



Electrical Characteristics- Capacitor (电容特性)

Capacitance Dielectric 电容介质	Capacitance Range 电容范围	Capacitance Tolerance 电容公差	Capacitance Voltage 电容电压
NPO	39pF~270pF	±10%	50V
X7R	>270pF~0.1μF	±20%	

Dimension (尺寸) (mm):

Type 类型	H (mm)	F (mm)
CNM	6.35 Max.	3.81 Max.
CNH	7.62 Max.	3.81 Max.

Dimension (尺寸) (mm):

L	
4 PIN: 10.2mm	10 PIN: 25.4mm
5 PIN: 12.7mm	11 PIN: 28.0mm
6 PIN: 15.3mm	12 PIN: 30.5mm
7 PIN: 17.8mm	13 PIN: 33.1mm
8 PIN: 20.4mm	14 PIN: 35.6mm
9 PIN: 22.9mm	

* Custom Design Circuit could be available on a case to case basis (可提供客户特殊要求之线路产品)

Feature (特性)

- Small size, Light weight 小尺寸, 重量轻
- High stability, Reliability 高稳定性, 高可靠性
- Max working voltage 10KV 最大工作电压可达10KV
- Used in Microwave Ovens, Induction Cooker, High Voltage Power Supply, Laser light control circuit and other applications
用于微波炉、电磁炉、高压电源、激光控制电路及其它产品

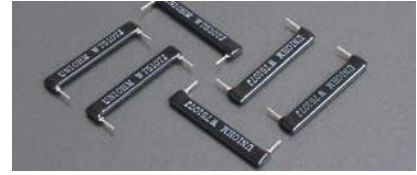

Dimension (尺寸) (mm)



Derating Curve & Specification (降功率曲线和性能)

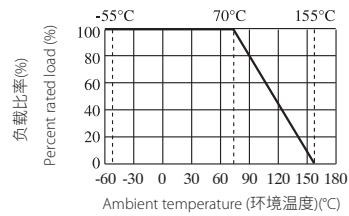

Part No. 料号	Type 类型	Power rating 功率 70°C	Dimension (尺寸)(mm)						Max Working Voltage 最大工作电压	Dielectric Withstanding Voltage 绝缘耐压	Resistance Range 阻值范围
			P±0.5	L(max) L 最大	d1±0.1	d2 ^{+0.5} -0.2	H(max) H 最大	T(max) T 最大			
HFR0W2	HFR-50	0.5W	17.8	20.4	0.5	3.5	5.08	2.5	5KV	500V	1M~1GΩ
HFR007	HFR-75	0.75W	22.9	25.4	0.5	3.5	5.08	2.5	10KV	500V	1M~1GΩ
HFR01W	HFR-100	1W	27.9	30.5	0.5	3.5	5.08	2.5	10KV	500V	1M~1GΩ

Performance Specification (性能)

Temperature coefficient 温度系数	±200PPM/°C	Humidity (Steady State) 恒定湿热	ΔR/R±(1.0%+0.1 Ω)
Terminal strength 端子强度	ΔR/R±(1%+0.1Ω)	Load life in humidity 湿度寿命	ΔR/R±(3.0%+0.1Ω)
Soldering heat 耐焊接热	ΔR/R±(1%+0.1 Ω)	Load life 负载寿命	ΔR/R±(3.0%+0.1Ω)
Solderability 可焊性	Min.95% coverage (最少 95% 覆盖率)	Insulation resistance 绝缘电阻	≥10,000MΩ
Rapid change of temperature 温度快速变化	ΔR/R±(1%+0.1 Ω)	Thermal shock 热冲击	ΔR/R±(1%+0.1Ω)

Ordering Procedure (Example: HFR 0.75W 10% 10M B/B)

订购方式 (例如: HFR 0.75W 10% 10M B/B)



Remark: Please refer to page 141 for ordering guide. 注: 下单请详见 P141 页说明。

Feature (特性)

- Small size and light weight (体积小, 重量轻)
- Lighting application (照明应用)
- Too low/high ohmic value can be supplied case to case basis (可特别提供过低/过高的欧姆值)
- Patent No:1581275 (专利号:1581275)



Dimension (尺寸) (mm)



Derating Curve (降功率曲线)



Type	Power 功率 at 70°C	D ±1	L ±1	H1 ±1.5	H2 ±1	h ±1	d ±0.05	t ±1	Tolerance 精度 %	Resistance Range 阻值範圍	Max Working Voltage 最大工作电压	Max Overload Voltage 最大过负荷电压	Dielectric Withstanding Voltage 绝缘耐压	Standard Color 标准色	Operating Temperature 工作温度
RC06	0.25W (1/4W)	5.5	6	13.5	4.5	3.5	0.68	3.5	Jumper 1%	<50mΩ 10Ω ~ 1MΩ	200V	400V	500V	Brown	-55 ~ +155°C
RC06-1	0.25W (1/4W)	5.5	7.5	13.5	4.5	3.5	0.68	4.5	5%	1Ω ~ 10MΩ	200V	400V	500V	Blue	

Performance Specification (性能)

Temperature Coefficient 温度系数	1Ω ~ 10Ω : ±400PPM/°C 11Ω ~ 100Ω : ±200PPM/°C >100Ω : ±100PPM/°C	Temperature Cycling 温度循环	±1% ; ±(0.5.0%+0.05Ω) ±5% ; ±(1.0%+0.05Ω)
Short Time Overload 短时间过负荷	±1% ; ±(1.0%+0.1Ω) ±5% ; ±(2.0%+0.1Ω)	Insulation Resistance 绝缘电阻	1,000 MΩ or more
Solderability 可焊性	Min. 95%coverage	Load Life in Humidity 湿度寿命	±1% ; ±(1.0%+0.1Ω) ±5% ; ±(3.0%+0.1Ω)
Resistance to Soldering Heat 耐焊接热	±(1.0%+0.05Ω)	Load Life 负载寿命	±1% ; ±(1.0%+0.1Ω) ±5% ; ±(3.0%+0.1Ω)

Ordering Procedure (Example: RC06 1/4W 1% 10Ω)

订购方式 (例如: RC06 1/4W 1% 10Ω)



Remark: Please refer to page 141 for ordering guide. 注: 下单请详见 P141 页说明。

Feature (特性)

- Self-extinguishing 完全不燃性
- Extremely small & sturdy mechanically safe 体积小且坚固安全
- Non-inductive type available 无感也可提供
- Excellent flame & moisture resistance 卓越抗湿性
- Too low or too high values on Wire-wound & Power-film type can be supplied on a case to case basis 过低或过高的阻值, 绕线或切割型都可以特别提供



Derating Curve (降功率曲线)



Heat Rise Chart (表面温升)



Axial Leaded Type-PRW Series (轴向导线型 -PRW 系列)



Part No. 料号	Type 类型	Dimension(尺寸)(mm)					Max. working voltage 最大工作电压	Max. Overload voltage 最大过负荷电压	Resistance Range 阻值范围	
		W±1	D±1	L±1	H	d±0.05			Wire-wound 绕线型	Power Film 膜层型
PRW01W	PRW1W	6	6	13.5	25±3	0.70	200V	400V	0.1Ω~27Ω	28Ω~100KΩ
PRW02W	PRW2W	7	7	18	28±5	0.70	250V	500V	0.1Ω~27Ω	28Ω~120KΩ
PRW03W	PRW3W	8	8	22	32±5	0.70	300V	600V	0.1Ω~39Ω	40Ω~150KΩ
PRW05W	PRW5W	10	9	22	35±5	0.75	350V	700V	0.1Ω~47Ω	48Ω~150KΩ
PRW07W	PRW7W	10	9	35	35±5	0.75	500V	1000V	0.1Ω~680Ω	681Ω~200KΩ
PRW0AW	PRW10W	10	9	49	35±5	0.75	700V	1400V	0.1Ω~910Ω	911Ω~200KΩ
PRW0FW	PRW15W	12.5	11.5	49	35±5	0.75	700V	1400V	1Ω~1.0KΩ	1.1KΩ~200KΩ
PRW020	PRW20W	14.5	13.5	60	35±5	0.75	750V	1500V	2Ω~1.2KΩ	1.3KΩ~200KΩ
PRW025	PRW25W	14.5	13.5	64	35±5	0.75	750V	1500V	2Ω~1.2KΩ	1.3KΩ~200KΩ

Axial Leaded Type-PRWC Series (轴向导线型 -PRWC 系列)



Part No. 料号	Type 类型	Dimension(尺寸)(mm)					Resistance Range 阻值范围	
		W±1	D±1	L±1	H	d±0.05	Wire-wound 绕线型	Power Film 膜层型
PRWC1W	PRWC-1W	6	6	12	25±3	0.70	1Ω~27Ω	28Ω~33KΩ
PRWC2W	PRWC-2W	6	6	18	28±5	0.70	1Ω~27Ω	28Ω~33KΩ
PRWC3W	PRWC-3W	6	6	20	28±5	0.70	1Ω~27Ω	28Ω~120KΩ
PRWC5W	PRWC-5W	6	6	25	35±5	0.75	1Ω~200Ω	201Ω~150KΩ
PRWC7W	PRWC-7W	9	9	25	35±5	0.75	1Ω~200Ω	201Ω~150KΩ

Axial Leaded Type-PRWC Series(轴向导线型 -PRWC 系列)



Part No. 料号	Type 类型	Dimension(尺寸)(mm)					Resistance Range 阻值范围	
		W±1	D±1	L±1	H±5	d±0.05	Wire-wound 绕线型	Power Film 膜层型
PRC14W	PRWC-1 4W	6.4	6.4	20	28	0.70	1Ω~200Ω	201Ω~100KΩ
PRC15W	PRWC-1 5W	6.4	6.4	25	28	0.70	1Ω~200Ω	201Ω~100KΩ
PRC16W	PRWC-1 6W	6.4	6.4	38	35	0.75	1Ω~200Ω	201Ω~100KΩ

Axial Leaded Type-PRWA Series(轴向导线型 -PRWA 系列)



Part No. 料号	Type 类型	Dimension(尺寸)(mm)					Resistance Range 阻值范围	
		W±1	D±1	L±1	H±5	d±0.05	Wire-wound 绕线型	Power Film 膜层型
PRWA2W	PRWA-2W	7	7	18	28	0.70	0.1Ω~27Ω	28Ω~120KΩ
PRWA5W	PRWA-5W	10	9	22	35	0.75	0.1Ω~47Ω	48Ω~150KΩ
PRWA7W	PRWA-7W	10	9	35	35	0.75	0.1Ω~680Ω	681Ω~200KΩ
PRWAAW	PRWA-10W	10	9	49	35	0.75	0.1Ω~910Ω	911Ω~200KΩ

*Max. working voltage&Max. Overloadvoltage Reference to PRW Type 最大工作电压、最大过负荷电压参考 PRW 规格

Radial Leaded Type-PRM Series(立式导线型-PRM系列)



Part No. 料号	Type 类型	Dimension(尺寸)(mm)					Max. working voltage 最大工作电压	Max. Overload voltage 最大过负荷电压	Resistance Range 阻值范围	
		W±1	D±1	L±1	P±1	d±0.05			Wire-wound 绕线型	Power Film 膜层型
PRM02W	PRM-2W	11.5	7.5	20	5	0.70	250V	500V	0.1Ω~27Ω	28Ω~120KΩ
PRM03W	PRM-3W	12.5	8.5	25	5	0.70	300V	600V	0.1Ω~39Ω	40Ω~150KΩ
PRM05W	PRM-5W	13	9	25	5	0.75	350V	700V	0.1Ω~47Ω	48Ω~150KΩ
PRM07W	PRM-7W	13	9	38	5	0.75	500V	1000V	0.1Ω~680Ω	681Ω~200KΩ
PRM0AW	PRM-10W	13	9	50	5	0.75	700V	1400V	0.1Ω~910Ω	911Ω~200KΩ
PRMA5W	PRMA-5W	13	9	25	7.5	0.75	350V	700V	0.1Ω~47Ω	48Ω~100KΩ
PRMAAW	PRMA-10W	16	12	35	7.5	0.75	700V	1400V	0.1Ω~560Ω	561Ω~100KΩ
PRMB7W	PRMB-7W	12.5	9	38	5	0.75	500V	1000V	0.1Ω~680Ω	681Ω~200KΩ

Radial Terminal Type-PRMT Series(轴向导线型-PRMT系列)



Part No. 料号	Type	Dimension(尺寸)(mm)					Max. working voltage 最大工作电压	Max. Overload voltage 最大过负荷电压	Resistance Range 阻值范围	
		W±1	D±0.5	L±1	P±1	d±0.05			Wire-wound 绕线型	Power Film 膜层型
PRMT15	PRMT15W	20	13	38	7.5	0.5	700V	1400V	0.1Ω~560Ω	561Ω~200KΩ
PRMT20	PRMT20W	20	13	45	7.5	0.4	750V	1500V		

Performance Specification (特性)

Temperature coefficient	温度系数	< 20Ω: ±400PPM; ≥20Ω: ±350PPM
Short-time Overload	短时间过负荷	ΔR/R±(5%+0.05 Ω), no evidence of mechanical damage(无可见机械损伤)
Dielectric withstanding voltage	绝缘耐压	no evidence of mechanical damage(无可见机械损伤)
Rapid change of temperature	温度快速变化	ΔR/R±(2%+0.05 Ω),no evidence of mechanical damage (无可见机械损伤)
Load life in humidity	湿度寿命	Wire-wound type(绕线型):ΔR/R=±5%
		Power Film type(膜层型):<100KΩ:ΔR/R=±5%; ≥100KΩ:ΔR/R=±10%
Load life	负载寿命	Wire-wound type(绕线型):ΔR/R=±5%
		Power Film type(膜层型):<100KΩ:ΔR/R=±5%; ≥100KΩ:ΔR/R=±10%

Ordering Procedure (Example: PRW 1W 5% 100Ω B/B)

订购方式 (例如: PRW 1W 5% 100Ω B/B)

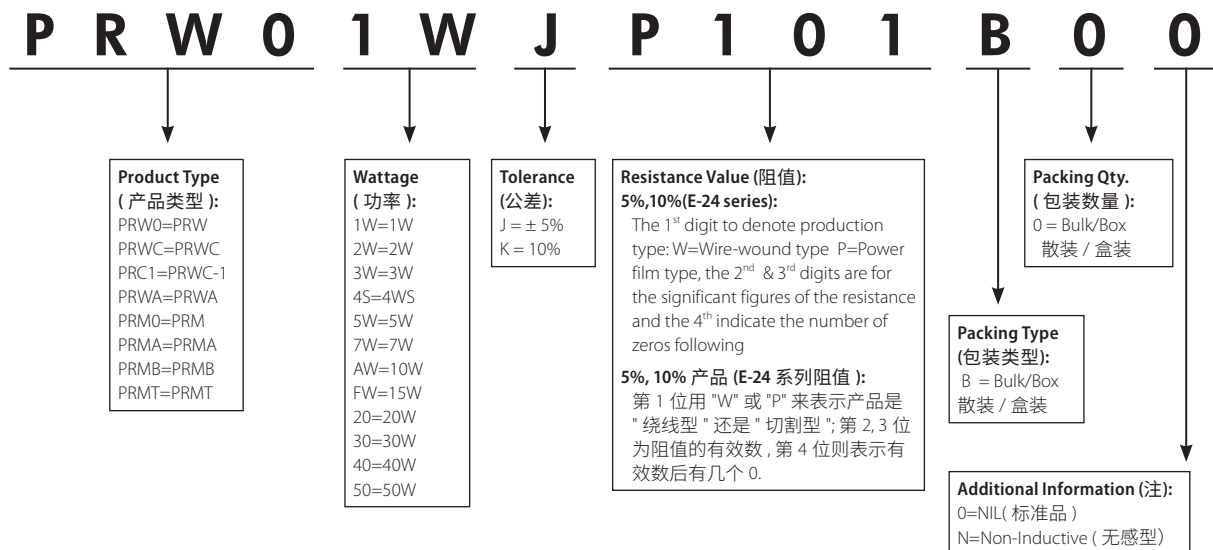

Feature (特性)

- Low inductance 低电感量
- Safety flamerproof construction 耐高温
- Thin & lightweight body save the PCB space considerably
体积小轻薄, 节省PCB空间



Derating Curve (降功率曲线)



Heat Rise Chart (表面温升)



PFAS (Single circuit-S Type) Dimension(mm)

PFAS(单电路-S型)尺寸(mm)



Type 类型	A±1.0	B±1.0	C±0.5	d±0.05	P±1	H±1	Resistance Range 阻值范围 (±5%、±10%)
PFAS2W	13	8.5	5	0.75	9	13	0.01Ω~1Ω
PFAS3W	14	13.5	5	0.75	10	13	0.01Ω~1Ω
PFAS5W	14	18	5	0.75	10	13	0.01Ω~1Ω
PFAS10W	26	18	5	0.75	20	13	0.01Ω~3.3Ω

PFAP (Single circuit-P Type) Dimension(mm)

PFAP(单电路-P型)尺寸(mm)



Type 类型	A±1.0	B±1.0	C±0.5	d±0.05	P±1	H±1	Resistance Range 阻值范围 (±5%、±10%)
PFAP2W	13	8.5	5	0.75	9		0.01Ω~1Ω
PFAP3W	14	13.5	5	0.75	10	4	0.01Ω~1Ω
PFAP5W	14	18	5	0.75	10	10	0.01Ω~1Ω
PFAP10W	26	18	5	0.75	20		0.01Ω~3.3Ω

PFAT (Twin circuit-S Type) Dimension(mm)

PFAT(双电路-S型)尺寸(mm)



Type 类型	A±1.0	B±1.0	C±0.5	d±0.05	P±1	H±1	Resistance Range 阻值范围 (±5%、±10%)
PFAT2W	26	9	5	0.75			0.05Ω~1Ω
PFAT3W	26	13	5	0.75	10	13	0.05Ω~1Ω
PFAT5W	26	18	5	0.75			0.05Ω~1Ω
PFAT7W	26	20	5	0.75			0.1Ω~1Ω

Performance Specification (特性)

Temperature coefficient	温度系数	0.01Ω~0.1Ω Please contact Uniroyal, ≥0.1Ω:±350PPM
Short-time Overload	短时间过负荷	ΔR/R≤±(2%+0.05Ω), with no evidence of mechanical damage (无可见机械损伤)
Dielectric withstanding voltage	绝缘耐压	2000V
Operating temperature	工作温度范围	-55°C~+200°C
Resistance to soldering heat	耐焊接热	ΔR/R±(1%+0.05 Ω) with no evidence of mechanical damage (无可见机械损伤)
Rapid change of temperature	温度快速变化	ΔR/R≤±(5%+0.05Ω), with no evidence of mechanical damage (无可见机械损伤)
Solderability	可焊性	Coverage must be over 95%.
Resistance to solvent	耐溶剂	No deterioration of protective coating and markings (包封层, 色码完整)
Humidity (Steady State)	恒定湿热	ΔR/R≤±(5%+0.05Ω), with no evidence of mechanical damage (无可见机械损伤)
Load life in humidity	湿度寿命	ΔR/R≤±(5%+0.05Ω), with no evidence of mechanical damage (无可见机械损伤)
Load life	负载寿命	ΔR/R≤±(5%+0.05Ω), with no evidence of mechanical damage (无可见机械损伤)

Ordering Procedure (Example: PFAS 5W ±5% 0.68Ω B/B)

订购方式 (例如: PFAS 5W ±5% 0.68Ω B/B)



Derating Curve (降功率曲线)



Heat Rise Chart (表面温升)



Radial Terminal Type - PRT (With metal mounting bracket)/PRU Series

立式端片型 PRT (带金属安装支架)/PRU

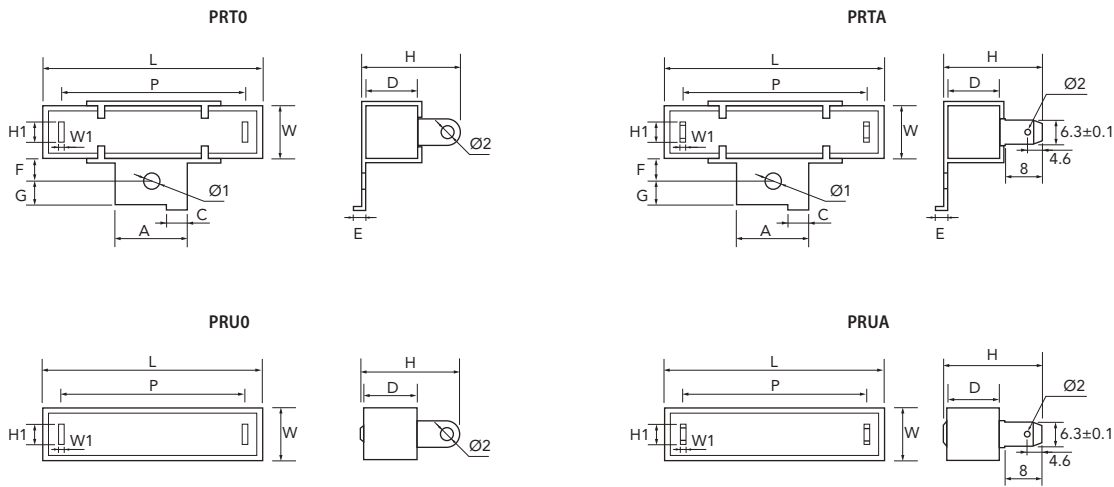

Type 类型	W ±1	D ±1	L ±1.5	P ±1	H ±1	A ±0.5	H1 ±0.4	C ±0.5	F ±0.5	G ±0.5	E ±1	Ø1 ±0.2	Ø2 ±0.2	W1 ±0.08	Resistance Range 阻值范围	
															Wire-wound 绕线型	Power Film 膜层型
10W	PRT0	10	9	48	32	18	5.5	3	8.7	5	3	4.1	2.5	0.5	1Ω~820Ω	821Ω~200KΩ
	PRU0															
15W	PRT0	12.5	11.5	48	32	21	6.2	3	8.0	6	3	4.1	2.5	0.5	1Ω~1KΩ	1.1KΩ~200KΩ
	PRU0															
20W	PRT0	12.5	13.5	63	44	21	6.2	3	10	6	3	4.1	2.5	0.5	2Ω~1.2KΩ	1.3KΩ~200KΩ
	PRU0															
30W	PRT0	19	19	75	54	32	7.6	3	9.5	7.5	4	4.1	3.2	0.5	3Ω~1.5KΩ	-
	PRU0															
40W	PRT0	19	19	90	70	32	7.6	3	9.5	7.5	4	4.1	3.2	0.5	6Ω~1.5KΩ	-
	PRU0															
50W	PRT0	19	19	90	70	32	7.6	3	9.5	7.5	4	4.1	3.2	0.5	6Ω~1.5KΩ	-
	PRU0															

Performance Specification (特性)

Temperature coefficient	温度系数	< 20Ω: ±400PPM; ≥20Ω: ±350PPM
Short-time Overload	短时间过负荷	ΔR/R±(5%+0.05 Ω), no evidence of mechanical damage(无可见机械损伤)
Dielectric withstanding voltage	绝缘耐压	no evidence of mechanical damage(无可见机械损伤)
Rapid change of temperature	温度快速变化	ΔR/R±(2%+0.05 Ω),no evidence of mechanical damage (无可见机械损伤)
Load life in humidity	湿度寿命	Wire-wound type(绕线型):ΔR/R=±5% Power Film type(膜层型):<100KΩ:ΔR/R=±5%; ≥100KΩ:ΔR/R=±10%
Load life	负载寿命	Wire-wound type(绕线型):ΔR/R=±5% Power Film type(膜层型):<100KΩ:ΔR/R=±5%; ≥100KΩ:ΔR/R=±10%

Ordering Procedure (Example: PRT 50W 5% 100Ω B/B)

订购方式 (例如: PRT 50W 5% 100Ω B/B)

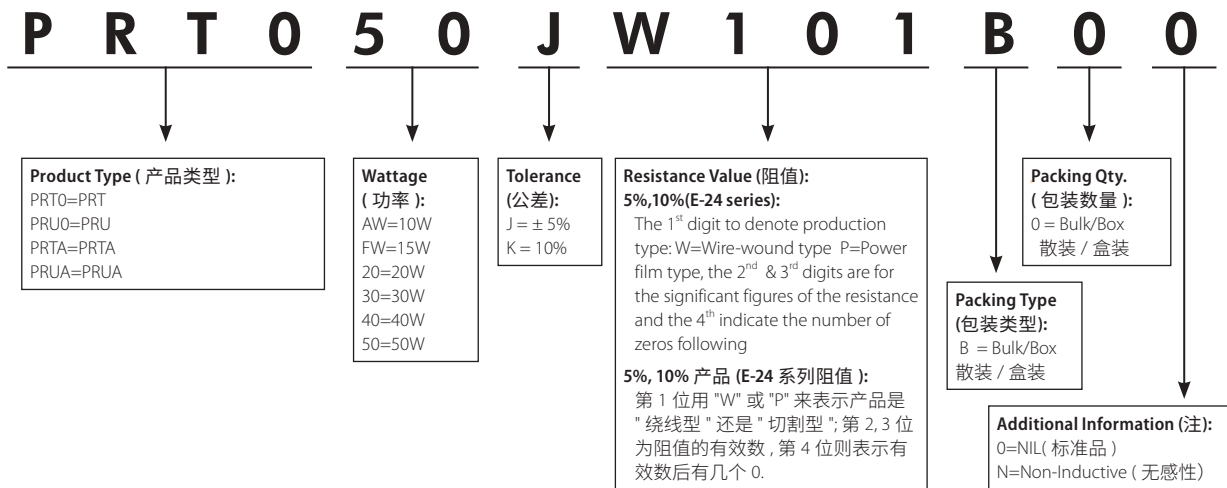

Feature (特性)

- Self-extinguishing 完全不燃性
- Extremely small & sturdy mechanically safe 体积小且坚固安全
- Excellent flame & moisture resistance 卓越抗湿性
- Too low or too high values on Wire-wound & Power-film type can be supplied on a case to case basis 过低或过高的阻值, 绕线或切割型都可以特别提供



Radial Terminal Type-PRVA Series

(立式端片型-PRVA系列)



Radial Terminal Type - PRVB Series

立式端片型-PRVB系列



类型 Type	W±1	D±1	L±1	P±1	Resistance Range 阻值范围
PRVA-3W PRVB-3W	10	9	22	9.5	0.1Ω~150KΩ
PRVA-5W PRVB-5W	10	9	27/25	15/9.5	0.1Ω~200KΩ
PRVA-7W PRVB-7W	10	9	35	22	0.1Ω~200KΩ
PRVA-10W PRVB-10W	10	9	48	35/32	1Ω~200KΩ
PRVA-15W PRVB-15W	12.5	11.5	48	32	1Ω~200KΩ
PRVA-20W PRVB-20W	12.5	13.5	63	42	1Ω~200KΩ

Radial Terminal Type-PRZ Series

(立式端片型-PRZ系列)

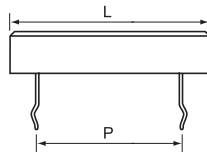

Type	W±1	D±1	L	P±1.5	Resistance Range 阻值范围
PRZA-1/PRZA-2/PRZC/PRZD 3 W	10	9	22±1	9.5	0.1~150KΩ
PRZA-1/PRZA-2/PRZA-3/PRZC/PRZD 5W	10	9	25/27±1	9.5/15	0.1Ω~200KΩ
PRZA-1/PRZA-2/PRZC/PRZD 7W	10	9	35±1	22	0.1Ω~200KΩ
PRZA-1/PRZA-2/PRZC/PRZD 10W	10	9	48±1.5	32/35	1Ω~200KΩ
PRZA-1/PRZA-2/PRZC/ 15W	12.5	11.5	48±1.5	32	1Ω~200KΩ
PRZA-1/PRZA-2/PRZC/ 20W	12.5	13.5	63±1.5	42/45	2Ω~200KΩ

Remark: For further information, please contact our sales team. 若需详细信息, 请联系我司销售。

Feature (特性)

- Self-extinguishing 完全不燃性
- Extremely small & sturdy mechanically safe 体积小且坚固安全
- Excellent flame & moisture resistance 卓越抗湿性
- Too low or too high values on Wire-wound & Power-film type can be supplied on a case to case basis 过低或过高的阻值, 绕线或切割型都可以特别提供



Radial Leaded Type-PRS Series(立式导线型-PRS系列)



Part No. 料号	Type	Dimension(尺寸)(mm)					Resistance Range 阻值范围
		W±1	D±1	L±1	P±1	d±0.05	
PRS05W	PRS-5W	10	9	22	5	0.75	0.1Ω~150KΩ
PRS07W	PRS-7W	10	9	35	10	0.75	0.1Ω~200KΩ
PRS0AW	PRS-10W	10	9	45	10	0.75	0.1Ω~200KΩ
PRS0FW	PRS-15W	12.5	13.5	49	11	0.75	0.1Ω~200KΩ
PRS020	PRS-20W	14.5	13.5	60	10	0.75	0.1Ω~200KΩ
PRS025	PRS-25W	14.5	13.5	64	10	0.75	0.1Ω~200KΩ

Radial Terminal Type Resistors (立式端片型电阻器)

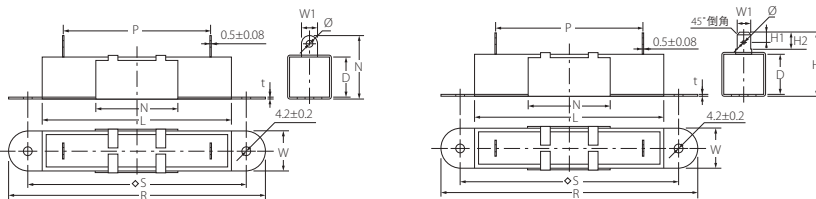

Type 类型	W±1	D±1	L±1.5	H±1	Resistance Range 阻值范围
PRTC/PRTD10W	10	9	48	18/19	1Ω~200KΩ
PRTC/PRTD15W	12.5	11.5	48	21/23.5	1Ω~200KΩ
PRTC/PRTD20W	12.5	13.5	63	21/25	2Ω~200KΩ
PRTC/PRTD30W	19	19	75	32/30	3Ω~1.5KΩ
PRTC/PRTD40W	19	19	90	32/30	6Ω~1.5KΩ
PRTC/PRTD50W	19	19	90	32/30	6Ω~1.5KΩ

Resistors of Capacitor Voltage Balance (电容电压平衡电阻器)



Type 类型	Dimension(尺寸)(mm)				Resistance Range 阻值范围
	W±1.0	D±1.5	L±1.5	P±1.5	
PRTM4W	12.5	12.5	48.0	27.0	1.3KΩ~200KΩ Power Film 切割型
PRTM7W	12.5	12.5	63.0	27.0	
PRTM20W	12.5	13.5	63.0	35.0	

Remark: For further information, please contact our sales team. 若需详细信息, 请联系我司销售。

Feature (特性)

- Square porcelain tube 方形瓷管外壳
- Excellent insulation and moisture resistance 优良的绝缘性和耐湿性
- Winding process, good resistance to load 绕线工艺, 良好的耐负荷能力
- Application: Power supply of frequency converter 应用: 变频器的电源



PHF1、PHF2、PHF3 Series

Type 类型	H±1.5	H1±0.5	D±0.5	D1±0.5	L	Resistance Range 阻值范围
PHF1/PHF2 4W	-	8.5	-	7.5	20±1	1Ω~1KΩ
PHF1/PHF2 5W	-	8.5	-	7.5	25±1	1Ω~2.2KΩ
PHF1/PHF2 7W	-	9.5	-	7.5	38±1	1Ω~6.2KΩ
PHF1/PHF2 9W	10	-	9	-	38±1	1Ω~6.2KΩ
PHF1/PHF2/PHF3 11W	10	-	9	-	50±1	1Ω~6.2KΩ
PHF1/PHF2/PHF3 17W	10	-	9	-	75±2	1Ω~10KΩ

PHF1type
卧式1型



PHF2type
卧式2型



PHF3 type
卧式3型



PRWI Series



Type 类型	W±1	D	L±1	H±1	d±0.05	Resistance Range 阻值范围
PRWI 4W	7.0	8±1	20	56	0.75	0.1Ω~6.8KΩ
PRWI 5W	7.5	8.5±1	25	60	0.75	0.1Ω~6.8KΩ
PRWI 7W	7.0	8±1	38	70	0.75	0.33Ω~22KΩ
PRWI 11W	9.0	10±1.5	50	85	0.75	0.33Ω~22KΩ
PRWI 17W	9.0	10±1.5	75	110	0.75	1Ω~39KΩ

Remark: For further information, please contact our sales team. 若需详细信息, 请联系我司销售。

Feature (特性)

- With Aluminum Shell for a good heat dissipation, suitable for board mount 铝外壳散热性能好, 适用于散热板安装
- Thin & lightweight body with big power rating 本体小而轻, 功率大
- Application: Power Supply, Adapter, Machine 应用: 设备电源类



Derating Curve (降功率曲线)

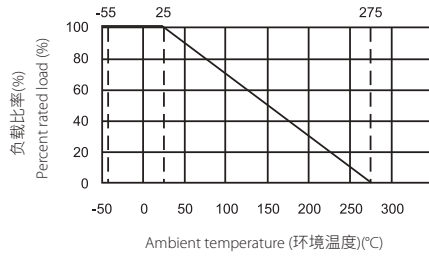

Type	L1±1	L2	L3	L4±1.5	W±1	H±1	D±1	d±0.2	D1	D2±0.5	D3	Resistance range 阻值范围	Special high value 特殊最高值
PDM 5W	15.5	11±0.5	12±0.5	32.5	16±0.5	8.0	8.0	0.3	2.0+0.5/-0.2	1.3	1±0.05	0.5Ω~1KΩ	1.8KΩ
PDM10W	20.5	15.2±0.5	17.2±0.5	40.5	22.3±0.5	12.2	11.0	0.8	2.5+0.5/-0.2	2.0	2±0.1	1Ω~1.5KΩ	5KΩ
PDM25W	28.0	18.2±0.5	20.2±0.5	45.5	30.3±0.5	16.0	13.5	0.8	3.0+0.5/-0.2	2.0	2±0.1	5.1Ω~8.2KΩ	12KΩ
	28.0	18±0.5	19.0±0.5	49.0	27±1	14.0	13.5	0.8	4+0.5/-0.2	/	2±0.1	5.1Ω~8.2KΩ	12KΩ
PDM35W	34.5	24.2±0.5	20.2±0.5	56.5	30±0.5	16.3	16.3	0.8	3.0+0.5/-0.2	2.0	2±0.1	5.1Ω~8.2KΩ	15KΩ
PDM50W	50.5	40.2±0.5	20.2±0.5	75.0	30.3±0.5	15.7	15.5	0.8	3.0+0.5/-0.2	2.0	2±0.1	5.1Ω~20KΩ	35KΩ
	50.0	40±1	21.5±0.5	78.5	30±1	16.0	15.5	0.8	3.5±0.5	/	2±0.1	5.1Ω~20KΩ	35KΩ
PDM5 25W	28.0	18±0.5	19±1	49.0	27±0.5	14.0	13.5	0.8	4±0.5	2.0	2±0.1	5.1Ω~8.2KΩ	22KΩ
PDM5 50W	50.0	40±0.5	21.5±1	75.0	30±0.5	16.0	15.5	0.8	3.5±0.5	2.0	2±0.1	5.1Ω~20KΩ	35KΩ
PDM-1 75W	66.0	36±0.5	37±1	88.0	47.5±1	26.0	27.0	1.1	4.5±0.5	2.0	2.3±0.2	1Ω~20KΩ	-
PDM-1 85W	75.5	40±0.5	20.5±1	100	29±1	15.5	15.5	0.8	3.5±0.5	2.0	2±0.1	1Ω~20KΩ	-
PDM-1 100W	98.0	72±1	37±1	120	48±1	26.0	27.0	0.8	4.5±0.5	2.0	2±0.1	1Ω~20KΩ	-

Remark: For further information, please contact our sales team. 若需详细信息, 请联系我司销售。

Feature (特性)

- Anti-vibration, high stability 优异的抗震性和稳定性
- Excellent transient current impact capability, suitable for the start of the inverter under harsh conditions 优良的瞬间电流冲击能力, 适合变频器严苛条件下的启动
- Application: Frequency Conversion Equipment, such as Elevator, Freezer, Crane, Lift etc. 应用: 各类变频设备中, 如电梯, 冷柜, 起重机, 升降机等



Derating Curve (降功率曲线)

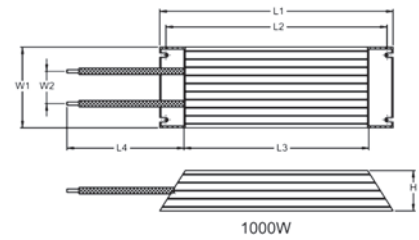
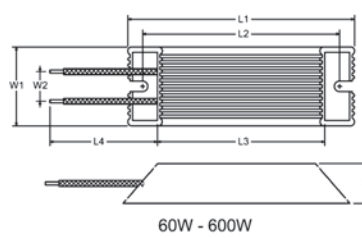

Type 类型	L1±2	L2±2	L3±2	L4±10	W1±2	W2±5	H±2	Resistance Range 阻值范围
HEWR60W	115	100	80	190	40	15	20	2Ω~2.5KΩ
HEWR80W	140	125	105	200	40	15	20	1Ω~3KΩ
HEWR100W	140	125	100	240	60	25	30	1Ω~4KΩ
HEWR100WS	165	150	125	240	40	15	20	1Ω~4KΩ
HEWR120W	190	175	150	240	40	15	20	1Ω~5KΩ
HEWR150W	215	200	175	240	40	15	20	1Ω~6KΩ
HEWR200W	165	150	125	255	60	25	30	1Ω~7KΩ
HEWR300W	215	200	175	255	60	25	30	1Ω~8KΩ
HEWR400W	265	250	225	255	60	25	30	0.5Ω~10KΩ
HEWR500W	335	320	295	255	60	25	30	0.5Ω~12KΩ
HEWR600W	335	320	295	255	60	25	30	0.5Ω~12KΩ
HEWR1000W	400	385	340	255	100	25	50	1Ω~15KΩ

HBWR Lead Type-HBWR 引线型



Type 类型	L1±2	L2±2	L3±2	W1±2	H±2	Resistance Range 阻值范围
HBWR200W	190	160	165	30	60	1Ω~7KΩ
HBWR300W	240	210	215	30	60	1Ω~8KΩ
HBWR400W	290	260	265	30	60	0.5Ω~10KΩ
HBWR500W	360	330	335	30	60	0.5Ω~12KΩ
HBWR600W	360	330	335	30	60	0.5Ω~12KΩ

Performance Specification (特性)

Temperature coefficient	温度系数	<20Ω:±400PPM; ≥20Ω:±350PPM
Short-time Overload	短时间过负荷	ΔR/R≤±(5%+0.05Ω), with no evidence of mechanical damage (无可见机械损伤)
Dielectric withstanding voltage	绝缘耐压	No evidence of flashover, mechanical damage.(无击穿、飞弧及可见机械损伤)
Rapid change of temperature	温度快速变化	ΔR/R≤±(2%+0.05Ω), with no evidence of mechanical damage (无可见机械损伤)
Humidity (Steady State)	恒定湿热	ΔR/R≤±(5%+0.05Ω), with no evidence of mechanical damage (无可见机械损伤)
Load life in humidity	湿度寿命	ΔR/R≤±(5%+0.05Ω), with no evidence of mechanical damage (无可见机械损伤)
Load life	负载寿命	ΔR/R≤±(5%+0.05Ω), with no evidence of mechanical damage (无可见机械损伤)

Ordering Procedure (Example: HEWR200W ±5% 10Ω B/B)

订购方式 (例如: HEWR200W±5% 10Ω B/B)



New/Old Part.no Contrast (新旧料号对照)

New Part.no 新料号	Old Part.no 旧料号
HEWR**J*****	HPAR**J*****

Remark: Please refer to page 141 for ordering guide. 注: 下单请详见 P141 页说明。

Feature (特性)

- Multi-terminal types & variable types available 多端子和多可调阻方式都可提供
- Small in size but capable of carrying high power load 小体型负载大功率
- Resistance value unchanged after long use, good resistivity to short time overload 长年使用不变阻值, 短时间过负荷表现良好
- High resistivity to heat, small resistance temperature coefficient and the change in resistance with temperature being linear 抗热, 温度系数低, 温度变化小
- Too low or high ohmic value can be supplied on a case to case basis 超低或超高阻值都可特别提供
- Adjustable & Multi-Resistor type is available 可调型与多阻型可提供
- Non-Inductive type is available 可提供无感型



Derating Curve (降功率曲线)

Power Wire-wound Resistors-QH&QL Type

功率绕线型 -- QH&QL Type

QH Type (QH 型)



(QH Type 20W~40W)



(QH Type 50W~600W)

QL Type (QL 型)



(QL Type 20W~40W)



(QL Type 50W~600W)

Type 类型	Dimension (尺寸)(mm)										Resistance range 阻值范围
	A±2	B	C±2	E	F	H1±2	H2±2	J±1	K±1	Φd±0.05	
QH/QL20W	22	50±2	70	75±2	102±2	25	50	5	19	4	1Ω~10KΩ
QH/QL25W	22	60±2	81	84±2	110±2	25	50	5	19	4	2Ω~12KΩ
QH/QL30W	22	75±2	95	99±2	126±2	25	50	5	19	4	2Ω~15KΩ
QH/QL40W	22	90±2	112	114±2	141±2	25	50	5	19	4	2Ω~20KΩ
QH/QL50W	30	75±2	110	103±2	133±2	34	64	6.3	27	5	3Ω~25KΩ
QH/QL60W	30	90±2	126	117±2	147±2	34	64	6.3	27	5	3Ω~30KΩ
QH/QL80W	30	115±2	150	143±2	173±2	34	64	6.3	27	5	3Ω~40KΩ
QH/QL100W	30	140±2	173	166±2	197±2	34	64	6.3	27	5	3Ω~50KΩ
QH/QL120W	30	165±2	200	193±2	223±2	34	64	6.3	27	5	4Ω~60KΩ
QH/QL150W	30	195±2	230	224±2	254±2	34	64	6.3	27	5	4Ω~70KΩ
QH/QL200W	30	254±2	289	282±2	312±2	34	64	6.5	27	5	5Ω~100KΩ
QH/QL300W	42	254±2	292	285±2	332±2	45	87	6.5	39	5	8Ω~150KΩ
QH/QL400W	42	330±3	364	364±3	410±3	45	87	6.5	39	5	10Ω~200KΩ
QH/QL600W	42	420±3	458	451±3	498±3	45	87	6.5	39	5	10Ω~200KΩ

Remark: For further information, please contact our sales team. 若需详细信息, 请联系我司销售。

Power Ribbon Wire-wound Resistors-QR&QRZG Type

功率合金带绕线型 -QR&QRZG Type

QR Type (QR 型)



QRZG Type (QRZG 型)



Type 类型	Dimension (尺寸)(mm)										Resistance range 阻值范围
	B	D±4	E	F	G±2	H1±2	H2±2	I±2	J±1	K±1	
QR/QRZG120W	115±2	36	143±2	173±2	28	34	64	16	6.3	27	0.2Ω~4Ω
QR/QRZG150W	140±2	36	166±2	197±2	28	34	64	16	6.3	27	0.3Ω~5Ω
QR/QRZG180W	165±2	36	193±2	223±2	28	34	64	16	6.3	27	0.3Ω~6Ω
QR/QRZG225W	195±2	36	224±2	254±2	28	34	64	16	6.3	27	0.4Ω~8Ω
QR/QRZG300W	254±2	36	282±2	312±2	28	34	64	16	6.3	27	0.5Ω~10Ω
QR/QRZG450W	254±2	48	285±2	332±2	40	45	87	25	6.5	39	0.8Ω~15Ω
QR/QRZG600W	330±3	48	364±3	410±3	40	45	87	25	6.5	39	1Ω~20Ω
QR/QRZG750W	300±3	58	332±3	384±3	50	57	102	34	8	48	1Ω~75Ω
QR/QRZG1000W	390±3	58	423±3	475±3	50	57	102	34	8	48	1Ω~100Ω

Ordering Procedure (Example: QRZG 225W ±5% 1.8Ω B/B)

订购方式 (例如: QRZG 225W ±5% 1.8Ω B/B)



Bilateral Cement Fixed Resistor-BCR Type

双体水泥固定电阻器 -BCR 型

- Small size & sturdy mechanically safe 尺寸小、机械性能安全
- High safety standard 安全系数高
- Application: Automobile and motorcycle 应用: 汽车、摩托车

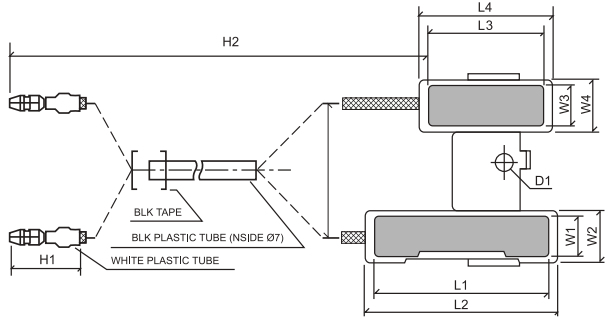

Type 类型	L1±0.5	L2±1	L3±0.5	L4±1	W1±0.5	W2±1	W3	W4±1	H1 Max.	H2+10/-0	D1+0.5/-0
BCR20W+5W	64	66	42	44	13	15	13±0.5	15	30	250	6.5

Thermal Fuse Wire-wound Resistors-ASSY Type

热熔保险丝型绕线电阻器 -ASSY 型

- High quality non-flame coating 高品质阻燃性涂装
- Self fusing 自熔断
- High current load and pulse capacity 高电流的负荷和脉冲能力
- Application: Automobile 应用: 汽车



Derating Curve (降功率曲线)



Type 类型	L1±3	L2±3	W±3	H(MAX)	T±0.2	Resistance Range 阻值范围
ASSY-4 Terminal	74	43	39	13	0.8	0.1Ω~10Ω
ASSY-5 Terminal	80	43	34	13	0.8	0.1Ω~10Ω

Remark: For further information, please contact our sales team. 若需详细信息, 请联系我司销售。

High Power Wire-wound Flat Aluminum Shell Fixed Resistors-HFWR Type 高功率绕线扁平铝壳电阻器 -HFWR 型

- Completely flame-retardant material 完全阻燃的材料
- Anti-vibration, high stability 优异的抗震性和稳定性
- Flat structure with great saving space 扁平式结构极大的节约空间
- Wire-wound process, good resistance to current impact
绕线工艺, 良好的耐电流冲击能力
- Application: Overload current protection of lithium battery pack in the start of new energy vehicle
应用: 新能源汽车启动时锂电池组的过载电流保护



Type 类型	L±1.0	L1±0.5	L2±0.3	W±0.3	W1±0.3
HFWR90W	70	53	39.7	51	41
HFWR330W	280	263	2*100	51	41

Cement Thermal Fusible Resistors

水泥热熔保险丝电阻器

- Self-extinguishing 自熄灭
- Excellent flame & moisture resistance 优异的阻燃性和抗湿性
- Extremely small & sturdy mechanically safe 体积小且坚固安全
- Non-inductive type available 无感也可提供
- Circuit protection applied to industrial and motor control 应用于工业和马达控制的电路保护
- Old Part.NO:PF2A~PF10D Series 旧料号PF2A~PF10D系列

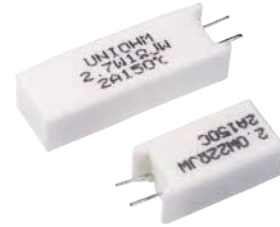

Type 类型	FTR2~FTR10
Thermal Cut-Off Temp. 动作温度	98°C ~235°C
Rated current 额定电流	2A or 10A
Rated voltage 额定电压	AC 250V
Wire-wound Resistance Range 阻值范围 (±5%、±10%)	0.22Ω~1.8KΩ



Vertical Type Shrapnel Fuse Resistors - PHF0 Type

立式弹片型保险丝电阻 - PHF0 型

- Elastic sheet metal, solder dot fuse, reliable circuit cut off function 弹性金属片, 锡点熔断型, 可靠的电路切断功能
- Fusing Temperature 220±20°C 熔断温度220±20°C
- Application: Over temperature protection of industrial power supply 应用: 工业电源部分的超温保护

Type 类型	L±1.0	W±1.0	H±1	L1±3	L2±1.5	L3±0.5	C±0.1	e±0.1	Φd±0.05
PHF-2W	25.0	9.0	10.0	38.0	13.0	4.5	3.0	0.9	0.75



Array Type Cement Temperature Fusing Resistors - TFRC Type

排列式水泥温度保险丝电阻器 - TFRC 型

- Multi lead arrange encapsulation & space saving 多引线排列封装、节约空间
- Excellent flame & moisture resistance 良好的阻燃性、抗湿性
- Application: Over temperature protection of industrial power supply 应用: 工业电源部分的超温保护

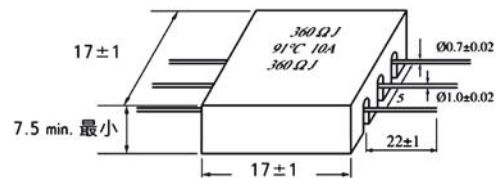

Type 类型	Fusing Temp. 熔断温度	Rated current 额定电流	Rated voltage 额定电压
TFRC-2W	91°C	10A	250V



Remark: For further information, please contact our sales team. 若需详细信息, 请联系我司销售。

Columnar Type Cement Fixed Resistors-QHO Type

圆柱状水泥电阻器 -QHO 型

- Circular ceramic 圆形瓷管外壳
- Excellent insulation and moisture resistance 优良的绝缘性和耐湿性
- Winding process, good resistance to load 绕线工艺, 良好的耐负荷能力
- Application: Power supply of frequency converter
应用: 变频器的电源



Type 类型	L±1	L1±3	ØD±1	d±0.05
QHO 4W	43	30	8	0.75
QHO 5W	45	30	8	0.75
QHO 7W	50	30	9	0.75
QHO 9W	60	30	9	0.75
QHO 11W	65	30	9	0.75
QHO 17W	75	30	9	0.75



Multi-Lead Wire-wound Fixed Resistors - KNHW Type

多引线型绕线固定电阻器 - KNHW 型

- All materials are inorganic and non-flammable
所有的材料均为无机或非燃性的固体材料
- Super heat dissipation & High stability 散热性高, 稳定性好
- Special design of Multi-lead wire easy to assembled on PCB
特殊设计的多导线易于在PCB上安装
- Application: Charging or discharging resistance of electrical equipment such as elevator
应用: 电气设备如电梯的充电电阻或放电电阻



Type 类型	L±1	A±1	F±1	P±1	ØD±1	d±0.05
KNHW10W	45	10	15	12	11.5	1.0
KNHW18W	40	12	18	15	14.5	1.0
KNHW25W	50	12	18	15	14.5	1.0
KNHW40W	65	12	20	17	16.5	1.0



High Power Flat Wire-wound Fixed Resistors - KNHB Type

高功率扁平型绕线固定电阻器

- All materials are inorganic and non-flammable
所有的材料均为无机或非燃性的固体材料
- Can withstand High Voltage pulse in short-time 短时间可承受高电压脉冲
- Can use in single or in-piles 可单个或成堆使用
- Application: Charging or discharging resistance of electrical equipment such as elevator
应用: 电气设备如电梯的充电电阻或放电电阻



Type 类型	A±2	B±1	C±0.5	D±1	L±1	N±2
KNHB21W	32	19	12	14	68	51
KNHB31W	51	19	12	14	87	70
KNHB53W	90	19	12	14	126	109
KNHB68W	120	19	12	14	156	140
KNHB91W	153	19	12	14	189	173



Remark: For further information, please contact our sales team. 若需详细信息, 请联系我司销售。

High Power Wire-wound Flat Aluminum Shell Fixed Resistors - HPWR Type

高功率绕线扁平铝壳电阻器 - HPWR 型

- Anti-vibration, high stability 优异的抗震性和稳定性
- Easy to assembled on PCB 易于在PCB上安装
- Application: Power supply of frequency converter
应用: 变频器的电源



Type 类型	L±1	L1±0.5	L2 ⁺²⁰ / ₋₀	W±0.5	W1±0.2	H±0.5
HPWR 40W	85	72	300	45	5.5	8.2



High Power Wire-wound Iron Shell Fixed Resistors - HPWR Type

高功率绕线铁壳固定电阻器 - HPWR 型

Type 类型	L±0.5	L1±0.5	W±0.5	H±0.5	L3±5
HPWR110W	105	91.5	44.6	11.5	300
HPWR120W	195	184	40	14	250
HPWR220W	200	187	44.6	11.5	250



High Power Wire-wound Iron-Case Resistors - HAWF Type

高功率绕线型铁壳固定电阻器 - HAWF 型

- Anti-vibration, high stability 优异的抗震性和稳定性
- Excellent transient current impact capability, suitable for the start of the inverter under harsh conditions
优良的瞬间电流冲击能力, 适合变频器严苛条件下的启动
- Application: Frequency Conversion Equipment, such as Elevator, Freezer, Crane, Lift etc.
应用: 各类变频设备中, 如电梯, 冷柜, 起重机, 升降机等



Type 类型	L±1	W±1	H±1	L1±1
HAWF30W	97	32	15	90.5
HAWF40W	85	32	20	20



Remark: For further information, please contact our sales team. 若需详细信息, 请联系我司销售。

High Power Wire-wound Aluminum Shell Resistance - HAWR Type

高功率绕线型铝壳电阻器 - HAWR 型

- Anti-vibration, high stability 优异的抗震性和稳定性
- Excellent transient current impact capability, suitable for the start of the inverter under harsh conditions
优良的瞬间电流冲击能力, 适合变频器严苛条件下的启动
- Application: Frequency Conversion Equipment, such as Elevator, Freezer, Crane, Lift etc.
应用: 各类变频设备中, 如电梯, 冷柜, 起重机, 升降机等



Type 类型	L1±1	L2±2	P±1	W1±1	W2±1	W3±0.5	W4±0.2	D±0.2	H±1
HAWR60W	100	75.5	90	30	28	16.5	4.5	4.6	16.5
HAWR80W	130.5	104.5	117.5	43	38.5	22	6.0	6.0	21
HAWR100W	130	110	118	42	39	22.5	6.0	6.0	20

Type A Packing- 包装类型 A (mm)



Type 类型	Qty/Plastic Bag(PCS) 每塑料袋数量	Qty/Inner Box(PCS) 每内盒数量	Qty/Carton (PCS) 每外箱数量	Carton Size L×W×H(±5%)	Gross Wt.±2Kgs	Packing Type 包装类型
PRW Series						
PRW 1W	10	500	3000	485×190×200	10.00	Type A1
PRW 2W	10	400	2400	485×190×200	8.00	Type A1
PRW 3W	10	500	3000	520×220×250	12.20	Type A1
PRW 5W	10	400	2400	520×220×250	13.72	Type A1
PRW 7W	10	300	1800	520×220×250	15.46	Type A1
PRW 10W	10	250	1500	520×220×250	18.39	Type A1
PRW 15W	10	70	420	510×200×250	8.20	Type A1
PRW 20W	10	60	360	510×200×250	10.75	Type A1
PRW 25W	10	60	360	510×200×250	11.22	Type A1
PRWA Series						
PRWA 5W	10	400	2400	520×220×250	15.00	Type A1
PRWA 7W	10	240	1440	520×220×250	14.20	Type A1
PRWA 10W	10	220	1320	520×220×250	16.30	Type A1
PRWC Series						
PRWC 3W	10	400	2400	485×190×200	7.30	Type A1
PRWC 5W	10	400	2400	485×190×200	9.40	Type A1
PRWC 7W	10	400	2400	520×220×250	14.00	Type A1
PRWC-1 Series						
PRC1 4W	50	500	3000	485×190×200	9.05	Type A2
PRC1 5W	10	600	3600	485×190×200	13.45	Type A1
PRC1 6W	40	400	2400	485×190×200	13.71	Type A2
PRT Series						
PRT 10W	10	200	1200	520×220×250	19.50	Type A1
PRT 15W	5	150	900	520×220×250	22.00	Type A1
PRT 20W	5	95	570	520×220×250	18.50	Type A1
PRT 30W	5	45	270	520×220×250	21.40	Type A1
PRT 40W	5	25	150	520×220×250	14.20	Type A1

Note: The above is recommended packaging, the actual packing method is in accordance with the order.

注: 以上为推荐包装方式, 实际以工厂依订单情形的包装方式为准

Type A Packing 包装类型 A (mm)



Dimension of Plastic Case (mm)			
Type	A	B	C
Type - B1	260	105	260
Type - B2	300	100	210
Type - B3	300	100	210



Type 类型	Qty/Plastic Bag(PCS) 每塑料袋数量	Qty/Inner Box(PCS) 每内盒数量	Qty/Carton (PCS) 每外箱数量	Carton Size L×W×H(±5%)	Gross Wt.±2Kgs	Packing Type 包装类型
PRM/FTR Series						
PRM2W	10 (in Bag)	700	4200	520×220×250	18.50	Type A1
PRM3W	100	500	2000	535×270×220	14.20	Type B1
PRM5W	100	500	2000	535×270×220	14.20	Type B1
PRM7W	75	375	1500	435×305×215	17.42	Type B2
PRM 10W	60	300	1200	435×305×215	18.12	Type B3
PFA 10W	10 (in Bag)	150	900	520×220×250	14.74	Type A1
PRMA Series						
PRMA 5W	100	500	2000	535×270×220	14.00	Type B1
PRMA 10W	10 (in Bag)	150	900	485×190×200	14.50	Type A1
PFAS & PFAT Series						
PFAS 2W	20 (in Bag)	600	3600	485×190×200	7.10	Type A1
PFAS 5W	20 (in Bag)	500	3000	485×190×200	9.72	Type A1
PFAS 7W	160	900	3600	435×305×215	16.20	Type B1
PFAS 10W	10 (in Bag)	500	3000	520×220×250	22.40	Type A1
PFAT 5W	10 (in Bag)	300	1800	485×190×200	13.20	Type A1
PFAT 7W	10 (in Bag)	250	1500	485×190×200	11.50	Type A1

Note: The above is recommended packaging, the actual packing method is in accordance with the order.
注: 以上为推荐包装方式, 实际以工厂依订单情形的包装方式为准

Type B Packing-Plastic Case 包装类型 B - 塑料盒 (mm)

Type 类型	Qty/Plastic Bag(PCS) 每塑料袋数量	Qty/Inner Box(PCS) 每内盒数量	Qty/Carton (PCS) 每外箱数量	Carton Size L×W×H(±5%)	Gross Wt.±2Kgs	Packing Type 包装类型
PRM/FTR Series						
PRM2W / PF2	10(in Bag)	700	4200	520×220×250	18.50	Type A1
PRM3W / PF3	100	500	2000	535×270×220	14.20	Type B1
PRM5W / PF5	100	500	2000	535×270×220	14.20	Type B1
PRM7W / PF7	75	375	1500	435×305×215	17.42	Type B2
PRM 10W	60	300	1200	435×305×215	18.12	Type B3
PFA 10W	10(in Bag)	150	900	520×220×250	14.74	Type A1
PRMA Series						
PRMA 5W	100	500	2000	535×270×220	14.00	Type B1
PRMA 10W	10(in Bag)	150	900	485×190×200	14.50	Type A1
PFAS & PFAT Series						
PFAS 2W	20(in Bag)	600	3600	485×190×200	7.10	Type A1
PFAS 5W	20(in Bag)	500	3000	485×190×200	9.72	Type A1
PFAS 7W	160	900	3600	435×305×215	16.20	Type B1
PFAS 10W	10(in Bag)	500	3000	520×220×250	22.40	Type A1
PFAT 5W	10(in Bag)	300	1800	485×190×200	13.20	Type A1
PFAT 7W	10(in Bag)	250	1500	485×190×200	11.50	Type A1
PRU Series						
PRU 10W	100	100	1000	560×305×310	12.50	Type D
PRU 15W	80	80	800	560×305×310	17.33	Type D
PRU 20W	60	60	600	560×305×310	17.85	Type D
PRU 30W	20	40	160	435×305×215	16.37	Type D
PRU 40W	20	20	160	435×305×215	16.37	Type D

Note: The above is recommended packaging, the actual packing method is in accordance with the order.

注: 以上为推荐包装方式, 实际以工厂依订单情形的包装方式为准

测试项目	引用标准	测试方法
Temperature coefficient 温度系数	GB/T 5729 4.8 JIS-C-5201 4.8 IEC 60115-1 4.8	Natural resistance change per temperature degree centigrade 实际阻值随温度变化的变化率： $\frac{R_2 - R_1}{R_1(t_2 - t_1)} \times 10^6 \text{ (PPM / } ^\circ\text{C)}$ R ₁ : Resistance value at room temperature 室温下的阻值 (t ₁); R ₂ : Resistance at test temperature (-55°C or +155°C) 在 -55°C 或者 +155°C 温度下的阻值； t ₁ : +25°C or specified room temperature +25°C 或者特殊要求的室内温度； t ₂ : -55°C or +155°C test temperature -55°C 或者 +155°C 的测试温度。
Short-time overload 短时间过负荷	GB/T 5729 4.13 JIS-C-5201 4.13 IEC 60115-1 4.13	Permanent resistance change after the application of a potential of 2.5 times RCWV or Max.Overload Votage whichever less for 5 seconds. 加 2.5 倍额定工作电压或最大过负荷电压 (取其低者), 持续 5 秒钟, 测阻值变化。
Insulation resistance 绝缘阻值	GB/T 5729 4.6 JIS-C-5201 4.6 IEC 60115-1 4.6	1. Chip Resistor: the measuring voltage shall be, measured with a direct voltage of (100±15)V or a voltage equal to the dielectric withstanding voltage, and apply for 1 min. 2. TH Resistor: the measuring voltage shall be equal to the dielectric withstanding voltage for resistor with an isolation voltage < 500V or (500±50)V DC, for resistors with an isolation voltage ≥ 500V. 1. 贴片电阻: 绝缘耐压 < 100V, 测试电压取绝缘耐压的电压; 绝缘耐压 ≥ 100V, 测试电压为 100±15VDC, 1 分钟后量测阻值。 2. 插件电阻: 绝缘耐压 < 500V, 测试电压取绝缘耐压的电压; 绝缘耐压 ≥ 500V. 测试电压为 500±50VDC, 1 分钟后量测阻值。
Dielectric Withstanding Voltage 绝缘耐压	GB/T 5729 4.7 JIS-C-5201 4.7 IEC 60115-1 4.7	Resistor shall be clamped in the trough of 90° metallic V-block and shall be tested at AC potential respectively specified in the given list of each product type for 60-70 seconds. For Cement Fixed Resistors, the testing voltage is 1000V. 电阻固定在 90° 的 V 型槽中, 根据不同产品规定交流电压, 持续 60~70 秒, 水泥型电阻电压设定为 1000V。
Pulse overload 脉冲过负荷	IEC 60115-1 4.39	Resistance change after 10000 cycles (1 second "ON", 25 seconds "OFF") at 4 times of RCWV or Max.Overload whichever less. 10000 次循环后变化 (1 秒 "通", 25 秒断) 4 倍工作电压或最大工作电压 (取其最低者)。 Remark: DIP resistor using 4 times of RCWV, Chip resistor using 2.5 times of RCWV 注: 传统电阻 : 4×U _r , 晶片电阻 : 2.5×U _r
Terminal strength 端子强度	GB/T 5729 4.16 JIS-C-5201 4.16 IEC 60115-1 4.16	Direct Load: Resistance at a 2.5kg direct load for 10 seconds in the direction of the longitudinal axis of the terminal leads. Twist Test: Terminal leads shall be bent through 90° at a point of about 6mm from the body of the resistor and shall be rotated through 360° about the original axis of the bent terminal in alternating direction for a total of 3 rotations. 直接负荷: 在电阻引线方向直接加 2.5 公斤力 10 秒。扭曲测试: 两端导线折弯 90 度在熔点 6mm 处交替旋转 360 度 3 次。
Terminal strength 端子强度	GB/T 5729 4.16 JIS-C-5201 4.16 IEC 60115-1 4.16	(Applicable for Resister Network 适用网络电阻) Tensile: 1KG, 30 seconds / Bending: 500g, 2 times 张力: 1KG, 30 秒 / 弯曲: 500g, 2 次。
Terminal bending 端子弯曲	GB/T 5729 4.33 JIS-C-5201 4.33 IEC 60115-1 4.33	(Applicable for CHIP Resistors 适用晶片电阻) Twist of Test Board: Y/X=3/90mm 60 seconds. 测试板弯曲: Y/X=3/90mm 60 秒。
Soldering heat 耐焊接热	GB/T 5729 4.18 JIS-C-5201 4.18 IEC 60115-1 4.18	(Applicable for CHIP Resistors 适用晶片电阻) Dip the resistor into a temperature of 260±5°C and hold it for a 10±1 seconds. 将电阻浸入到 260±5°C 的锡炉中并保持 10 秒时间
Soldering heat 耐焊接热	GB/T 5729 4.18 JIS-C-5201 4.18 IEC 60115-1 4.18	(Applicable for TH Resistors 适用插件电阻) Permanent resister change when leads immersed to a point 2.0~2.5mm from the body in 260±5°C solder 10±1 seconds. 锡炉温度 260±5°C, 浸入深度: 离本体导线根部约 2.0~2.5mm, 处浸入时间 10±1 秒。
Solderability 可焊性	GB/T 5729 4.17 JIS-C-5201 4.17 IEC 60115-1 4.17	The area covered with a new, smooth, clean, shiny and continuous surface free from concentrated pinholes. Temperature of solder: 245±3°C; Dwell time in solder: 2~3 seconds. 表面光滑、清洁、均匀、有光泽, 锡炉温度: 245±3°C; 浸入时间: 2~3 秒。
Resistance to solvent 耐溶剂	GB/T 5729 4.29 JIS-C-5201 4.29 IEC 60115-1 4.29	Specimens shall be immersed in a bath of IPA completely for a 5±0.5 minutes using ultrasonic test equipment. 电阻浸入异丙醇超声波清洗 5±0.5 分钟。
Rapid change of temperature 温度快速变化	GB/T 5729 4.19 JIS-C-5201 4.19 IEC 60115-1 4.19	30 min at -55 °C and 30 min at 155°C; 100 cycles -55 °C 温度放置 30min, 155 °C 温度放置 30min, 100 个循环;
High Temperature Exposure 高温暴露	MIL-STD-202 108A	Exposed to a temperature of 155±2°C for 1000H. 在 155±2°C 的环境下放置 1000H。
Low Temperature Storage 低温存放	IEC 60068-2-1 (Aa)	Exposed to a temperature of -55±3°C for 2H. 在 -55±3°C 的环境下放置 2H。
Leaching 金属融出	J-STD-002 Test D	Samples completely immersed for 30 sec in solder bath at 260°C, no visible damage. 样品浸入 260°C 的焊锡炉 30S, 无明显的损伤。
Load life in humidity 湿度寿命	GB/T 5729 4.24 JIS-C-5201 4.24 IEC 60115-1 4.24	Resistance change after 1000 hours (1.5 hours "ON", 0.5 hours "OFF") at RCWV or Max. Working Voltage whichever less in a humidity test chamber controlled at 40±2°C and 90~95% RH. 持续时间: 1000h (1.5h "通", 0.5h "断"); 试验温度: 40±2°C; 相对湿度: 90~95% RH; 试验电压: 额定工作电压或最大工作电压 (取其低者)。
Load life 负载寿命	GB/T 5729 4.25.1 JIS-C-5201 4.25.1 IEC 60115-1 4.25.1	Permanent Resistance change after 1000 hours operating at RCWV or Max. Working Voltage whichever less with duty cycle of 1.5 hours "ON", 0.5 hour "OFF" at 70±2°C ambient. 持续时间: 1000h (1.5h "通", 0.5h "断"); 试验温度: 70±2°C; 试验电压: 额定工作电压或最大工作电压 (取其低者)。
Accidental overload 意外过载	GB/T 5729 4.26 JIS-C-5201 4.26 IEC 60115-1 4.26	Resistors shall resist flaming or arcing when overload up to 5, 10, 16, 25, 40, 63, 100 times power or 4 times Max. Working Voltage, whichever less. 施加 5, 10, 16, 25, 40, 63 和 100 倍额定功耗的过负荷, 但所加的电压不超过 4 倍的最大工作电压, 测试其阻燃性。
** RCWV =	Rated Continuous Working Voltage 额定持续工作电压	$= \sqrt{\text{Rated Power} \times \text{Resistance Value}}$ = $\sqrt{\text{额定功率} \times \text{阻值}}$ the calculated value or the Max. Working Voltage whichever less. 计算值或该产品最大工作电压取其低者

The below chart shows the nominal resistance value for each series. The values in the chart have been in this order using the approximate values that are based on the common ratios given in the following table:

下表列出每种系列的标准阻值，表中的阻值是按照通用倍率得出的接近阻值。

Series 系列	Common Ratio 通用倍率	Remarks 备注
E-6	$\sqrt[6]{10}$ (1.46)	Rounded off to a 2-digit figure (2 位有效数字)
E-12	$\sqrt[12]{10}$ (1.21)	Rounded off to a 2-digit figure (2 位有效数字)
E-24	$\sqrt[24]{10}$ (1.10)	Rounded off to a 2-digit figure (2 位有效数字)
E-96	$\sqrt[96]{10}$ (1.02)	Rounded off to a 3-digit figure (3 位有效数字)

E-6	E-12	E-24	E-96	E-6	E-12	E-24	E-96	E-6	E-12	E-24	E-96	
1.0	1.0	1.0	1.00	2.2	2.2	2.2	2.15	4.7	4.7	4.7	4.64	
			1.02				2.21				4.75	
			1.05				2.26				4.87	
			1.07				2.32				4.99	
		1.1	1.10			2.37	5.11					
			1.13			2.43	5.23					
			1.15			2.49	5.36					
			1.18			2.55	5.49					
	1.2	1.2	1.21	2.61	5.6	5.6	5.6			5.62		
			1.24	2.67						5.76		
			1.27	2.74						5.90		
			1.30	2.80						6.04		
		1.3	1.33	2.87			6.19					
			1.37	2.94			6.34					
			1.40	3.01			6.49					
			1.43	3.09			6.65					
1.5	1.5	1.5	1.47	3.3	3.3	3.3	3.16	6.8	6.8	6.8	6.81	
			1.50				3.24				6.98	
			1.54				3.32				7.15	
			1.58				3.40				7.32	
		1.6	1.62				3.48				7.50	
			1.65				3.57				7.68	
			1.69				3.65				7.87	
			1.74				3.74				8.06	
	1.8	1.8	1.78			3.83	8.2			8.2	3.9	8.25
			1.82			3.92						8.45
			1.87			4.02						8.66
			1.91			4.12						8.87
		2.0	1.96			4.22					9.09	
			2.00			4.32					9.31	
			2.05			4.42					9.53	
			2.10			4.53					9.76	

E-24 series standard resistance value & the codes to be used in the part No. system 2%, 5% & 10% tolerance (4 digits, start with "0"):

E-24 系列标准阻值和料号系统使用代码 (4 位, 以 0 为首位, 2%、5%、10% 公差):

Value 阻值	Code 代码	Value 阻值	Code 代码	Value 阻值	Code 代码	Value 阻值	Code 代码	Value 阻值	Code 代码	Value 阻值	Code 代码	Value 阻值	Code 代码
1.0Ω	010J	10Ω	0100	100Ω	0101	1.0KΩ	0102	10KΩ	0103	100KΩ	0104	1.0MΩ	0105
1.1Ω	011J	11Ω	0110	110Ω	0111	1.1KΩ	0112	11KΩ	0113	110KΩ	0114	1.1MΩ	0115
1.2Ω	012J	12Ω	0120	120Ω	0121	1.2KΩ	0122	12KΩ	0123	120KΩ	0124	1.2MΩ	0125
1.3Ω	013J	13Ω	0130	130Ω	0131	1.3KΩ	0132	13KΩ	0133	130KΩ	0134	1.3MΩ	0135
1.5Ω	015J	15Ω	0150	150Ω	0151	1.5KΩ	0152	15KΩ	0153	150KΩ	0154	1.5MΩ	0155
1.6Ω	016J	16Ω	0160	160Ω	0161	1.6KΩ	0162	16KΩ	0163	160KΩ	0164	1.6MΩ	0165
1.8Ω	018J	18Ω	0180	180Ω	0181	1.8KΩ	0182	18KΩ	0183	180KΩ	0184	1.8MΩ	0185
2.0Ω	020J	20Ω	0200	200Ω	0201	2.0KΩ	0202	20KΩ	0203	200KΩ	0204	2.0MΩ	0205
2.2Ω	022J	22Ω	0220	220Ω	0221	2.2KΩ	0222	22KΩ	0223	220KΩ	0224	2.2MΩ	0225
2.4Ω	024J	24Ω	0240	240Ω	0241	2.4KΩ	0242	24KΩ	0243	240KΩ	0244	2.4MΩ	0245
2.7Ω	027J	27Ω	0270	270Ω	0271	2.7KΩ	0272	27KΩ	0273	270KΩ	0274	2.7MΩ	0275
3.0Ω	030J	30Ω	0300	300Ω	0301	3.0KΩ	0302	30KΩ	0303	300KΩ	0304	3.0MΩ	0305
3.3Ω	033J	33Ω	0330	330Ω	0331	3.3KΩ	0332	33KΩ	0333	330KΩ	0334	3.3MΩ	0335
3.6Ω	036J	36Ω	0360	360Ω	0361	3.6KΩ	0362	36KΩ	0363	360KΩ	0364	3.6MΩ	0365
3.9Ω	039J	39Ω	0390	390Ω	0391	3.9KΩ	0392	39KΩ	0393	390KΩ	0394	3.9MΩ	0395
4.3Ω	043J	43Ω	0430	430Ω	0431	4.3KΩ	0432	43KΩ	0433	430KΩ	0434	4.3MΩ	0435
4.7Ω	047J	47Ω	0470	470Ω	0471	4.7KΩ	0472	47KΩ	0473	470KΩ	0474	4.7MΩ	0475
5.1Ω	051J	51Ω	0510	510Ω	0511	5.1KΩ	0512	51KΩ	0513	510KΩ	0514	5.1MΩ	0515
5.6Ω	056J	56Ω	0560	560Ω	0561	5.6KΩ	0562	56KΩ	0563	560KΩ	0564	5.6MΩ	0565
6.2Ω	062J	62Ω	0620	620Ω	0621	6.2KΩ	0622	62KΩ	0623	620KΩ	0624	6.2MΩ	0625
6.8Ω	068J	68Ω	0680	680Ω	0681	6.8KΩ	0682	68KΩ	0683	680KΩ	0684	6.8MΩ	0685
7.5Ω	075J	75Ω	0750	750Ω	0751	7.5KΩ	0752	75KΩ	0753	750KΩ	0754	7.5MΩ	0755
8.2Ω	082J	82Ω	0820	820Ω	0821	8.2KΩ	0822	82KΩ	0823	820KΩ	0824	8.2MΩ	0825
9.1Ω	091J	91Ω	0910	910Ω	0911	9.1KΩ	0912	91KΩ	0913	910KΩ	0914	9.1MΩ	0915
												10MΩ	0106

E-96 series standard resistance value & the codes to be used in the part No. system not over 1% tolerance (4 digits):

E-96 系列标准阻值和料号系统使用代码 (4 位, 0.1%、0.25%、0.5%、1% 公差):

Value 阻值	Code 代码	Value 阻值	Code 代码	Value 阻值	Code 代码	Value 阻值	Code 代码	Value 阻值	Code 代码	Value 阻值	Code 代码	Value 阻值	Code 代码	Value 阻值	Code 代码
10.0Ω	100J	17.8Ω	178J	31.6Ω	316J	56.2Ω	562J	100Ω	1000	178Ω	1780	316Ω	3160	562Ω	5620
10.2Ω	102J	18.2Ω	182J	32.4Ω	324J	57.6Ω	576J	102Ω	1020	182Ω	1820	324Ω	3240	576Ω	5760
10.5Ω	105J	18.7Ω	187J	33.2Ω	332J	59.0Ω	590J	105Ω	1050	187Ω	1870	332Ω	3320	590Ω	5900
10.7Ω	107J	19.1Ω	191J	34.0Ω	340J	60.4Ω	604J	107Ω	1070	191Ω	1910	340Ω	3400	604Ω	6040
11.0Ω	110J	19.6Ω	196J	34.8Ω	348J	61.9Ω	619J	110Ω	1100	196Ω	1960	348Ω	3480	619Ω	6190
11.3Ω	113J	20.0Ω	200J	35.7Ω	357J	63.4Ω	634J	113Ω	1130	200Ω	2000	357Ω	3570	634Ω	6340
11.5Ω	115J	20.5Ω	205J	36.5Ω	365J	64.9Ω	649J	115Ω	1150	205Ω	2050	365Ω	3650	649Ω	6490
11.8Ω	118J	21.0Ω	210J	37.4Ω	374J	66.5Ω	665J	118Ω	1180	210Ω	2100	374Ω	3740	665Ω	6650
12.1Ω	121J	21.5Ω	215J	38.3Ω	383J	68.1Ω	681J	121Ω	1210	215Ω	2150	383Ω	3830	681Ω	6810
12.4Ω	124J	22.1Ω	221J	39.2Ω	392J	69.8Ω	698J	124Ω	1240	221Ω	2210	392Ω	3920	698Ω	6980
12.7Ω	127J	22.6Ω	226J	40.2Ω	402J	71.5Ω	715J	127Ω	1270	226Ω	2260	402Ω	4020	715Ω	7150
13.0Ω	130J	23.2Ω	232J	41.2Ω	412J	73.2Ω	732J	130Ω	1300	232Ω	2320	412Ω	4120	732Ω	7320
13.3Ω	133J	23.7Ω	237J	42.2Ω	422J	75.0Ω	750J	133Ω	1330	237Ω	2370	422Ω	4220	750Ω	7500
13.7Ω	137J	24.3Ω	243J	43.2Ω	432J	76.8Ω	768J	137Ω	1370	243Ω	2430	432Ω	4320	768Ω	7680
14.0Ω	140J	24.9Ω	249J	44.2Ω	442J	78.7Ω	787J	140Ω	1400	249Ω	2490	442Ω	4420	787Ω	7870
14.3Ω	143J	25.5Ω	255J	45.3Ω	453J	80.6Ω	806J	143Ω	1430	255Ω	2550	453Ω	4530	806Ω	8060
14.7Ω	147J	26.1Ω	261J	46.4Ω	464J	82.5Ω	825J	147Ω	1470	261Ω	2610	464Ω	4640	825Ω	8250
15.0Ω	150J	26.7Ω	267J	47.5Ω	475J	84.5Ω	845J	150Ω	1500	267Ω	2670	475Ω	4750	845Ω	8450
15.4Ω	154J	27.4Ω	274J	48.7Ω	487J	86.6Ω	866J	154Ω	1540	274Ω	2740	487Ω	4870	866Ω	8660
15.8Ω	158J	28.0Ω	280J	49.9Ω	499J	88.7Ω	887J	158Ω	1580	280Ω	2800	499Ω	4990	887Ω	8870
16.2Ω	162J	28.7Ω	287J	51.1Ω	511J	90.9Ω	909J	162Ω	1620	287Ω	2870	511Ω	5110	909Ω	9090
16.5Ω	165J	29.4Ω	294J	52.3Ω	523J	93.1Ω	931J	165Ω	1650	294Ω	2940	523Ω	5230	931Ω	9310
16.9Ω	169J	30.1Ω	301J	53.6Ω	536J	95.3Ω	953J	169Ω	1690	301Ω	3010	536Ω	5360	953Ω	9530
17.4Ω	174J	30.9Ω	309J	54.9Ω	549J	97.6Ω	976J	174Ω	1740	309Ω	3090	549Ω	5490	976Ω	9760



Value 阻值	Code 代码	Value 阻值	Code 代码	Value 阻值	Code 代码	Value 阻值	Code 代码	Value 阻值	Code 代码	Value 阻值	Code 代码	Value 阻值	Code 代码	Value 阻值	Code 代码
1.00K	1001	2.37K	2371	5.62K	5621	13.3K	1332	31.6K	3162	75.0K	7502	178K	1783	422K	4223
1.02K	1021	2.43K	2431	5.76K	5761	13.7K	1372	32.4K	3242	76.8K	7682	182K	1823	432K	4323
1.05K	1051	2.49K	2491	5.90K	5901	14.0K	1402	33.2K	3322	78.7K	7872	187K	1873	442K	4423
1.07K	1071	2.55K	2551	6.04K	6041	14.3K	1432	34.0K	3402	80.6K	8062	191K	1913	453K	4533
1.10K	1101	2.61K	2611	6.19K	6191	14.7K	1472	34.8K	3482	82.5K	8252	196K	1963	464K	4643
1.13K	1131	2.67K	2671	6.34K	6341	15.0K	1502	35.7K	3572	84.5K	8452	200K	2003	475K	4753
1.15K	1151	2.74K	2741	6.49K	6491	15.4K	1542	36.5K	3652	86.6K	8662	205K	2053	487K	4873
1.18K	1181	2.80K	2801	6.65K	6651	15.8K	1582	37.4K	3742	88.7K	8872	210K	2103	499K	4993
1.21K	1211	2.87K	2871	6.81K	6811	16.2K	1622	38.3K	3832	90.9K	9092	215K	2153	511K	5113
1.24K	1241	2.94K	2941	6.98K	6981	16.5K	1652	39.2K	3922	93.1K	9312	221K	2213	523K	5233
1.27K	1271	3.01K	3011	7.15K	7151	16.9K	1692	40.2K	4022	95.3K	9532	226K	2263	536K	5363
1.30K	1301	3.09K	3091	7.32K	7321	17.4K	1742	41.2K	4122	97.6K	9762	232K	2323	549K	5493
1.33K	1331	3.16K	3161	7.50K	7501	17.8K	1782	42.2K	4222	100K	1003	237K	2373	562K	5623
1.37K	1371	3.24K	3241	7.68K	7681	18.2K	1822	43.2K	4322	102K	1023	243K	2433	576K	5763
1.40K	1401	3.32K	3321	7.87K	7871	18.7K	1872	44.2K	4422	105K	1053	249K	2493	590K	5903
1.43K	1431	3.40K	3401	8.06K	8061	19.1K	1912	45.3K	4532	107K	1073	255K	2553	604K	6043
1.47K	1471	3.48K	3481	8.25K	8251	19.6K	1962	46.4K	4642	110K	1103	261K	2613	619K	6193
1.50K	1501	3.57K	3571	8.45K	8451	20.0K	2002	47.5K	4752	113K	1133	267K	2673	634K	6343
1.54K	1541	3.65K	3651	8.66K	8661	20.5K	2052	48.7K	4872	115K	1153	274K	2743	649K	6493
1.58K	1581	3.74K	3741	8.87K	8871	21.0K	2102	49.9K	4992	118K	1183	280K	2803	665K	6653
1.62K	1621	3.83K	3831	9.09K	9091	21.5K	2152	51.1K	5112	121K	1213	287K	2873	681K	6813
1.65K	1651	3.92K	3921	9.31K	9311	22.1K	2212	52.3K	5232	124K	1243	294K	2943	698K	6983
1.69K	1691	4.02K	4021	9.53K	9531	22.6K	2262	53.6K	5362	127K	1273	301K	3013	715K	7153
1.74K	1741	4.12K	4121	9.76K	9761	23.2K	2322	54.9K	5492	130K	1303	309K	3093	732K	7323
1.78K	1781	4.22K	4221	10.0K	1002	23.7K	2372	56.2K	5622	133K	1333	316K	3163	750K	7503
1.82K	1821	4.32K	4321	10.2K	1022	24.3K	2432	57.6K	5762	137K	1373	324K	3243	768K	7683
1.87K	1871	4.42K	4421	10.5K	1052	24.9K	2492	59.0K	5902	140K	1403	332K	3323	787K	7873
1.91K	1911	4.53K	4531	10.7K	1072	25.5K	2552	60.4K	6042	143K	1433	340K	3403	806K	8063
1.96K	1961	4.64K	4641	11.0K	1102	26.1K	2612	61.9K	6192	147K	1473	348K	3483	825K	8253
2.00K	2001	4.75K	4751	11.3K	1132	26.7K	2672	63.4K	6342	150K	1503	357K	3573	845K	8453
2.05K	2051	4.87K	4871	11.5K	1152	27.4K	2742	64.9K	6492	154K	1543	365K	3653	866K	8663
2.10K	2101	4.99K	4991	11.8K	1182	28.0K	2802	66.5K	6652	158K	1583	374K	3743	887K	8873
2.15K	2151	5.11K	5111	12.1K	1212	28.7K	2872	68.1K	6812	162K	1623	383K	3833	909K	9093
2.21K	2211	5.23K	5231	12.4K	1242	29.4K	2942	69.8K	6982	165K	1653	392K	3923	931K	9313
2.26K	2261	5.36K	5361	12.7K	1272	30.1K	3012	71.5K	7152	169K	1693	402K	4023	953K	9533
2.32K	2321	5.49K	5491	13.0K	1302	30.9K	3092	73.2K	7322	174K	1743	412K	4123	976K	9763
														1M	1004

** All values shown above are standard resistance values, other values could also be provided on a case to case basis (MOQ requested)

** 以上所有阻值都是标准阻值, 其他阻值可以特别提供, 但有相应 MOQ 之要求。



The standard Part No. includes 14 digits with the following explanation (标准料号包括 14 位数字, 注释如下):

1. 1st~4th digits (第 1 位 ~ 第 4 位):
 - a) This is to indicate the SMD Resistor size. Example (表示晶片电阻的尺寸, 例如): 1206, TC05 or HV03;
 - b) For Resistor Network & Coated type, the 1st~3rd digits are to indicate the product type and the 4th digit is the special feature. Example: RNLA = Resistor Network Circuit A type; CFRF = Carbon Film Fixed Resistors Non-Flame type; MORI = Metal Oxide Film Fixed Resistor Non-Inductive type. 网络电阻和涂装型电阻第 1 位到第 3 位表示产品类型, 第 4 位表示特殊形态, 如: RNLA = 网络电阻 A 型; CFRF = 不燃性碳膜电阻器; MORI = 无感型金属氧化膜电阻器。
 - c) For Cement Fixed Resistors, these 4 digits are to indicate the product type but if the product type has only 3 digits, the 4th digit will be "0". Example: PRW0=PRW type; PRWC=PRWC type. 水泥型前 4 位表示产品类型, 如果产品只有 3 个字母, 第 4 位为 0, 例: PRW0=PRW 型; PRWC=PRWC 型。

2. 5th~ 6th digits (第 5 位 ~ 第 6 位):
 - a) This is to indicate the wattage or power rating. To distinguish the sizes and the numbers, the following codes are used, and please refer to the following chart for details: W = Normal Size; S = Small Size; U = Ultra Small Size; "1"~"G" to denotes "1"~"16" as Hexadecimal: 表示产品标识功率, 为区别不同尺寸, 同时使用以下字母, 如: W = 正常尺寸; S = 小尺寸; U = 超小尺寸; "1"~"G" 代表 "1"~"16" 为 16 进制。

1/16W ~ 1/2W (<1W)

Wattage 功率	1/2	1/3	1/4	1/5	1/6	1/7	1/8	1/9	1/10	1/11	1/12	1/13	1/14	1/15	1/16
Normal Size 正常尺寸	W2	W3	W4	W5	W6	W7	W8	W9	WA	WB	WC	WD	WE	WF	WG
Small Size 小尺寸	S2	S3	S4	S5	S6	S7	S8	S9	SA	SB	SC	SD	SE	SF	SG
Ultra Small Size 超小尺寸	U2	U3	U4	U5	U6	U7	U8	U9	UA	UB	UC	UD	UE	UF	UG

1W ~ 16W (≥1W)

Wattage 功率	1	2	3	4	5	6	7	8	9	10	11	12	13	14	15	16
Normal Size 正常尺寸	1W	2W	3W	4W	5W	6W	7W	8W	9W	AW	BW	CW	DW	EW	FW	GW
Small Size 小尺寸	1S	2S	3S	4S	5S	6S	7S	8S	9S	AS	BS	CS	DS	ES	FS	GS
Ultra Small Size 超小尺寸	1U	2U	3U	4U	5U	6U	7U	8U	9U	AU	BU	CU	DU	EU	FU	GU

- b) For power rating less than 1W, the 5th digit will be the letters W, S or U to represent the size required & the 6th digit will be a number or a letter code. Example: WA = 1/10W; U2 = 1/2W-SS (功率小于 1 瓦, 第 5 位用 W, S 或 U 表示尺寸要求, 第 6 位将是数字或字母, 例: WA = 1/10W; U2 = 1/2W-SS).
 - c) For power rating of 1W to 16W, the 5th digit will be a number or a letter code and the 6th digit will be the letters of W, S or U. Example: AW = 10W; 3S = 3W-S. 当功率为 1 到 16 瓦, 第 5 位将是数字或字母, 第 6 位是 W, S 或 U. 例: AW = 10W; 3S = 3W-S.
 - d) For power rating between 20W to 99W, the 5th & 6th digits will show the whole numbers of the power rating itself. Example: 20 = 20W; 75 = 75W. 当功率在 20 瓦 ~99 瓦之间第 5 位至第 6 位全部表示功率. 例: 20 = 20W; 75 = 75W.
 - e) For power rating of 100W & over, the 5th & 6th digits will be indicated with "00" and the actual wattage being indicated at the last 3 digits (12th~14th) of the Part No. 当大于 100 瓦时第 5 位和第 6 位表示为 "00" 实际功率表示在料号最后 3 位 (12 位 ~ 14 位)
 - f) For special power ratings, the following codes are to be used (特殊功率用下列数字表示):
 - 1). WH = 1/32W (10P8 Chip Network 网络电阻)
 - 2). 07 = 3/4WS [Chip 2010 size (晶片 2010 尺寸)]
 - 3). 04 = 0.4W-SS (0.4 watt Ultra Small size 超小尺寸)
 - 4). 06 = 0.6W-S (0.6 watt Small size 小尺寸)
 - 5). 2A = 2.5W
 - 6). 6A = 6.5W
 - 7). WK = 2/3W
 - 8). 1A = 1.5W
 - 9). 1.25W = 1Q
 - g) For Resistor Network, since the power rating is fixed as 1/8W for A circuit & 1/5W for B circuit, the 5th & 6th digit is to be used to denote the number of pins required. Example: 09 = 9pins; 12 = 12pins. (网络电阻功率固定为 1/8W 或 1/5W, 故第 5 位和第 6 位用来表示所需要的 pins 数. 例: 09 = 9pins; 12 = 12pins.)
 - h) For Jumper Wires the 5th & 6th digits will be indicated with "00". (跳线电阻的第 5 位、第 6 位用 "00" 来表示)
 - i) For Thin Film Chip Resistors, these 2 digits will be used to indicate the requested Temperature coefficient: 对于薄膜晶片电阻产品, 这两位用来表示产品的温度系数要求:
 - 1). 05 = 5PPM
 - 2). 10 = 10PPM
 - 3). 15 = 15PPM
 - 4). 25 = 25PPM
 - 5). 50 = 50PPM
3. The 7th digit is to denote the Resistance Tolerance. The following letter code is to be used for indicating the standard Resistance Tolerance. As for Metal Film Fixed Resistor products, it is also to denote the standard PPM as follows (第 7 位表示阻值误差. 下列数码用来表示标准误差, 用于金属膜产品时, 同时用来表示标准 PPM, 如下):

B = ±0.1% (15PPM)	G = ±2% (100PPM)	W = ±0.05%
C = ±0.25% (25PPM)	J = ±5% (200PPM)	L = ±0.01%
D = ±0.5% (50PPM)	K = ±10%	
F = ±1% (50PPM)		

Remark: if it is not one of the above standard "tolerance-TCR", the requirement should be clearly stated when placing order. Example: ±1% (25PPM), the 7th digit still shows "F" but separately note the requirement of "25PPM"

注: 如果一个不是上述标准 "公差-PPM" 的要表示清楚 例: ±1% (25PPM), 第 7 位要标示 "F" 并另注 "25PPM"

4. The 8th to 11th digits is to denote the Resistance Value (第 8 位 ~ 第 11 位表示阻值):

- For the standard resistance values of E-24 series in 5% & 10% tolerance, the 8th digit is "0", the 9th & 10th digits are to denote the significant figures of the resistance and the 11th digit is the number of zeros following (对于 E-24 系列的 5%、10% 产品, 第 8 位数是 0, 第 9 位数和第 10 位数表示阻值的有效数, 第 11 位表示有几个 0).
- For the standard resistance values of E-96 series in $\leq 2\%$ tolerance, the 8th digit to the 10th digits are to denote the significant figures of the resistance and the 11th digit is the number of zeros following (对于 E-96 系列 $\leq 2\%$ 的产品, 第 8 位数到第 10 位数表示阻值的有效数, 第 11 位数表示有几个 0).
- For the code to the significant figures to E-24 & E-96 series, please refer to page 170 & 171 of the standards Resistance Value list.(有效数 E-24 和 E-96 系列, 请参考 170 页和 171 页标准阻值表)
- The following numbers and the letter codes is to be used to indicate the number of zeros in the 11th digit:

以下数字及字母用来表示第 11 位数有几个 0:

0 = 10 ⁰	1 = 10 ¹	2 = 10 ²	3 = 10 ³	4 = 10 ⁴	5 = 10 ⁵	6 = 10 ⁶
J = 10 ⁻¹	K = 10 ⁻²	L = 10 ⁻³	M = 10 ⁻⁴	N = 10 ⁻⁵	P = 10 ⁻⁶	

- For Cement Resistors the 8th digit will be coded with "W" or "P" to denote Wire-wound type or Power Film type respectively of the Cement Fixed Resistor product. The 9th to 11th please refer to point 4.a (水泥电阻第 8 位数 "W" 或 "P" 用来表示绕线型或切割型, 第 9 位数到第 11 位数请参考 4.a) Example (例):

E-24 series 系列	E-96 series 系列	Cement Resistors 水泥型固定电阻值
0120 = 12 ohm	1210 = 121 ohm	W120 = 12 ohm Wire-wound type 绕线型
0123 = 12K ohm	1302 = 13K ohm	W12J = 1.2 ohm Wire-wound type 绕线型
012J = 1.2 ohm	196J = 19.6 ohm	P273 = 27 kohm Powe Film type 切割型

5. The 12th, 13th & 14th digits (第 12 位数、13 位数和 14 位数):

- The 12th digit is to denote the Packaging type with the following codes (第 12 位数表示包装方式, 采用如下代码):
 A = Tape / Box (Ammo Pack) [编带 / 盒装 (带装)] C = Bulk in Cassette (for Chip product)[散装盒 (晶片产品)]
 B = Bulk / Box (散装 / 盒装) T = Tape / Reel (编带 / 卷装) P = Tape / Box of PT-26 product [编带 / 盒装 (PT-26 产品)]
- The 13th digit is normally to indicate the Packing Quantity of Tape/Box or Tape/Reel packaging types. Except for Chip products Bulk packing, this digit should be filled "0" or other products with "Bulk/Box packaging requirement. The following letter codes is to be used for some packaging quantities (第 13 位数一般表示包装数量对于 T/B 或 T/R 型, 除了晶片散装外, 其他产品的散装包装用 "0" 表示数量。下列字母说明包装数量).
 A = 500pcs (只) B = 2,500pcs (只) C = 10,000pcs (只) N = 12,500pcs (只) E = 15,000pcs (只)
 D = 20,000pcs (只) G = 25,000pcs (只) L = 45,000pcs (只) H = 50,000pcs (只) J = 60,000pcs (只)

Example (例):

CHIP product (晶片产品)	Other products (其它产品)
TD = T/R-20,000	A5 = T/B-5,000
TE = T/R-15,000	TB = T/R-2,500
T4 = T/R-4,000	B0 = B/B (可提供标准包装)

- For the Forming type products, the 13th & 14th digits are used to denote the forming types of the product with the following letter codes (对于成型产品第 13 位数和第 14 位数用来表示成型产品, 如下字母表示):

MF = M type with Flattened lead wire (M 型打扁加工)	F0 = F type 型
MK = M type with Kinked lead wire (M 型打弯加工)	F1 = F1 type 型
ML = M type with normal lead wire (M 型加工)	F2 = F2 type 型
MC = M type with kinked lead wire (M 型打弯加工)	F3 = F3 type 型

- For power rating over 100watt, the 12th to the 14th digits are to denote the actual wattage of the products (当功率超过 100W 时, 它的第 12 位数到 14 位数用来表示产品的实际功率):

Example (例): 100 = 100watt (瓦) 150 = 150watt (瓦) 225 = 225watt (瓦)

- For some products, the 14th digit alone can use to denote special features or additional information with the following codes (对于某些产品第 14 位可以显示特性和附加信息, 如下字母):

P = Panasert type (Panasert 型)	1 = Avisert 1 type (Avisert 1 型)	2 = Avisert 2 type (Avisert 2 型)
3 = Avisert 3 type (Avisert 3 型)	A = CO 1/4W - A type (切割型 CO 1/4W-A 型)	B = CO 1/4W - B type (切割型 CO 1/4W-B 型)
E = used to denote the "Environment Protection, lead Free type" of SMD category resistors (now, this became the Standard type of SMD) (晶片电阻, 晶片排阻及网络电阻器 "环保无铅型")		

- For some products, the 14th digit alone can use to denote special features or additional information with the following codes (对于某些产品第 14 位可以显示特性和附加信息, 如下字母):

B=1/32W	C=1/16W	F=1/10W	G=1/8W	H=1/6W	J=1/4W	K=1/3W	M=1/2W
N=3/4W	P=1W	S=Special					

4 Band Color Code (available for CFR, MOR, KNP & 2% or 5% of MF products)

4 道色码 (适用于 CFR, MOR, KNP & 2% 或 5% of MF 产品)



4th Band
第四道

Red 红	= ±2%
Gold 金	= ±5%
Silver 银	= ±10%

1st Band
第一道

Black 黑	= 0
Brown 棕	= 1
Red 红	= 2
Orange 橙	= 3
Yellow 黄	= 4
Green 绿	= 5
Blue 蓝	= 6
Violet 紫	= 7
Gray 灰	= 8
White 白	= 9

2nd Band
第二道

Black 黑	= 0
Brown 棕	= 1
Red 红	= 2
Orange 橙	= 3
Yellow 黄	= 4
Green 绿	= 5
Blue 蓝	= 6
Violet 紫	= 7
Gray 灰	= 8
White 白	= 9

3rd Band
第三道

Black 黑	= Multiply by 乘积倍数 1 (10^0)
Brown 棕	= Multiply by 乘积倍数 10 (10^1)
Red 红	= Multiply by 乘积倍数 100 (10^2)
Orange 橙	= Multiply by 乘积倍数 1,000 (10^3)
Yellow 黄	= Multiply by 乘积倍数 10,000 (10^4)
Green 绿	= Multiply by 乘积倍数 100,000 (10^5)
Blue 蓝	= Multiply by 乘积倍数 1,000,000 (10^6)
Violet 紫	= Multiply by 乘积倍数 10,000,000 (10^7)
Gold 金	= Multiply by 乘积倍数 0.1 (10^{-1})
Silver 银	= Multiply by 乘积倍数 0.01 (10^{-2})

5 Band Color Code (available for MF 1% & FRN Products)

5 道色码 (适用于 MF 1% & FRN 产品)



5th Band
第五道

Violet 紫	= ±0.1%
Blue 蓝	= ±0.25%
Green 绿	= ±0.5%
Brown 棕	= ±1%

1st Band
第一道

Black 黑	= 0
Brown 棕	= 1
Red 红	= 2
Orange 橙	= 3
Yellow 黄	= 4
Green 绿	= 5
Blue 蓝	= 6
Violet 紫	= 7
Gray 灰	= 8
White 白	= 9

2nd Band
第二道

Black 黑	= 0
Brown 棕	= 1
Red 红	= 2
Orange 橙	= 3
Yellow 黄	= 4
Green 绿	= 5
Blue 蓝	= 6
Violet 紫	= 7
Gray 灰	= 8
White 白	= 9

3rd Band
第三道

Black 黑	= 0
Brown 棕	= 1
Red 红	= 2
Orange 橙	= 3
Yellow 黄	= 4
Green 绿	= 5
Blue 蓝	= 6
Violet 紫	= 7
Gray 灰	= 8
White 白	= 9

4th Band
第四道

Black 黑	= Multiply by 乘积倍数 1 (10^0)
Brown 棕	= Multiply by 乘积倍数 10 (10^1)
Red 红	= Multiply by 乘积倍数 100 (10^2)
Orange 橙	= Multiply by 乘积倍数 1,000 (10^3)
Yellow 黄	= Multiply by 乘积倍数 10,000 (10^4)
Green 绿	= Multiply by 乘积倍数 100,000 (10^5)
Blue 蓝	= Multiply by 乘积倍数 1,000,000 (10^6)
Violet 紫	= Multiply by 乘积倍数 10,000,000 (10^7)
Gold 金	= Multiply by 乘积倍数 0.1 (10^{-1})
Silver 银	= Multiply by 乘积倍数 0.01 (10^{-2})

Ceramic Rods For Resistors (电阻器用陶瓷基体)



Ceramic Rod (瓷棒)	146	1.3×2.7, 1.7×5.2, 1.7×5.5, 1.7×6.0, 2.0×7.5, 2.0×8.0, 2.5×8.0, 3.0×8.0, 3.0×10, 3.5×10, 4.0×14, 5.0×16, 7.0×23
---------------------	-----	--

Capped & Sorted Ceramic Rod (组帽棒)



White Capped Ceramic Rod (组帽瓷棒)	148	1.3×2.7, 1.7×5.2, 1.7×5.5, 1.7×6.0, 2.0×7.5, 2.0×8.0, 2.5×8.0, 3.0×8.0, 3.0×10, 3.5×10, 4.0×14, 5.0×16, 7.0×23
------------------------------------	-----	--



Carbon Film Capped Ceramic Rod (碳膜组帽棒)	150	1.3×2.7, 1.7×5.2, 1.7×5.5, 1.7×6.0, 2.0×7.5, 2.0×8.0, 2.5×8.0, 3.0×8.0, 3.0×10, 3.5×10, 4.0×14, 5.0×16, 7.0×23
---	-----	--



Metal Film Capped Ceramic Rod (金属膜组帽棒)	152	1.3×2.7, 1.7×5.2, 1.7×5.5, 1.7×6.0, 2.0×7.5, 2.0×8.0, 2.5×8.0, 3.0×8.0, 3.0×10, 3.5×10, 4.0×14, 5.0×16, 7.0×23
---	-----	--



Metal Oxide Film Capped Ceramic Rod (金属氧化膜组帽棒)	154	1.3×2.7, 1.7×5.2, 1.7×5.5, 1.7×6.0, 2.0×7.5, 2.0×8.0, 2.5×8.0, 3.0×8.0, 3.0×10, 3.5×10, 4.0×14, 5.0×16, 7.0×23
---	-----	--



Capped Metal Glaze Film Rod (玻璃釉膜组帽棒)	156	1.3×2.7, 1.7×5.2, 1.7×5.5, 1.7×6.0, 2.0×7.5, 2.0×8.0, 2.5×8.0, 3.0×8.0, 3.0×10, 3.5×10, 4.0×14, 5.0×16
--	-----	--



Capped Chemical Deposited Film Rod (化学沉积膜组帽棒)	158	1.3×2.7, 1.7×5.2, 1.7×5.5, 1.7×6.0, 2.0×7.5, 2.0×8.0, 2.5×8.0, 3.0×8.0, 3.0×10, 3.5×10, 4.0×14, 5.0×16, 7.0×23
--	-----	--



Zero Ohm Rod (零欧姆棒)	160	1.3×2.7, 1.7×5.2
------------------------	-----	------------------

Tin-Plated Steel Cap (镀锡铁帽)



Tin-Plated Steel Cap (镀锡铁帽)	162	Ø1.26, Ø1.64, Ø1.95, Ø2.45, Ø2.90, Ø3.41, Ø3.91, Ø4.90, Ø6.90
--------------------------------	-----	---

Ceramic Case (瓷壳)



PRW series Case (PRW 系列瓷壳)	163	2W, 3W, 5W, 7W, 10W, 15W, 20W, 25W
PRM series Case (PRM 系列瓷壳)	163	2W, 3W, 5W, 7W, 10W, 15W, 20W, 25W
PRV series Case (PRV 系列瓷壳)	163	3W, 5W, 7W, 10W, 15W, 20W
PRT series Case (PRT 系列瓷壳)	163	10W, 15W, 20W, 30W, 40W
PFA series Case (PFA 系列瓷壳)	163	2W, 3W, 5W, 7W, 10W

Packing (包装)



Ceramic Rod (瓷棒)	165
Filmed & Capped Rod (组帽棒)	165
Zero Ohm Rod (零欧姆棒)	166
Tin-Plated Steel Cap (铁帽)	166

Material 材质		Alumina 氧化铝瓷							
Product Code 产品代号		FS-25	FS-55	FS-70	FS-75	FS-80	FS-85	FS-92	FS-98
Chemical Analysis 主成份		AL ₂ O ₃ 25%	AL ₂ O ₃ 55%	AL ₂ O ₃ 70%	AL ₂ O ₃ 75%	AL ₂ O ₃ 80%	AL ₂ O ₃ 85%	AL ₂ O ₃ 92%	AL ₂ O ₃ 98%
Appearance 外观		Dense 致密质	Dense 致密质	Dense 致密质	Dense 致密质	Dense 致密质	Dense 致密质	Dense 致密质	Dense 致密质
Color 呈色		White 白色	White 白色	White 白色	White 白色	White 白色	White 白色	White 白色	White 白色
Features 特征		Good Heat Resistance, High Thermal Conductivity 耐热性优良, 热传导性高							
Main Use 主要用途		Wire-wound Resistor 绕线电阻器用			Film Resistor 膜式电阻器用			Small-size & High power resistor 大功率小型化电阻器用	
Water Absorption 吸水率	%	≤ 0.02	≤ 0.02	≤ 0.01	≤ 0.01	≤ 0.01	≤ 0.01	< 0.02	< 0.02
Bulk Density 体积密度	g / cm ³	≥ 2.3	≥ 2.8	≥ 3.1	≥ 3.2	≥ 3.2	≥ 3.45	≥ 3.6	≥ 3.8
Thermal Expansion Coefficient 热膨胀系数	×10 ⁻⁶ /°C (20-500°C)	> 4.0	> 5.5	> 6.1	> 6.7	> 7.0	> 7.3	> 7.0	> 7.7
Thermal Conductivity 热传导率	Cal/ cm.sec. °C	> 0.003	> 0.008	> 0.011	> 0.020	> 0.015	> 0.023	> 0.040	> 0.050
Dielectric Strength 绝缘强度	KV/mm	> 9	> 10	> 10	> 10	> 10	> 10	> 10	> 10
Dielectric Constant 绝缘常数	1MHZ	9.5	9.5	9.5	9.5	9.5	9.5	9.5	9.5
Loss Rate 损失率	1MHZ	< 0.001	< 0.001	< 0.001	< 0.001	< 0.001	< 0.0001	0.0001	0.0001
Anti-cross break strength 抗折力	Kg	> 9	> 10	> 12	> 12	> 16	> 16	> 16	> 16



Feature (特性)

- Aluminum Content 70%, 80%, 85%. (70%, 80%, 85% 含铝量瓷棒)
- Electronic Ceramic parts in superior performance. (属于优良电子陶瓷产品)
- Suitable for producing in different types of resistance film.
(适合生产各种膜层的电阻)



Dimension (尺寸) (单位: mm)

NO	Size 规格	D 直径	L 长度	R	
				(Ra MIN 最小)	(Rb MAX 最大)
1	1.3×2.7	1.30±0.02	2.7±0.1	0.15	0.45
2	1.7×5.2	1.70±0.03	5.2 ^{+0.1} _{-0.2}	0.20	0.65
3	1.7×5.5	1.70±0.03	5.5±0.2	0.20	0.65
4	1.7×6.0	1.70±0.03	6.0±0.2	0.20	0.65
5	2.0×7.5	2.00 ^{+0.04} _{-0.03}	7.5±0.2	0.25	0.75
6	2.0×8.0	2.00±0.03	8.0±0.2	0.25	0.75
7	2.5×8.0	2.50±0.04	8.0±0.2	0.28	0.80
8	3.0×8.0	3.00±0.04	8.0±0.2	0.30	1.00
9	3.0×10	3.00±0.04	10.0±0.3	0.30	1.00
10	3.5×10	3.50 ^{+0.04} _{-0.05}	10.0±0.3	0.30	1.00
11	4.0×14	4.00±0.05	14.0±0.3	0.35	1.20
12	5.0×16	5.00±0.05	16.0±0.3	0.45	1.40
13	7.0×23	7.00±0.07	23.0±0.5	0.75	2.00

Remark: any special dimensions (4.0×12, 4.0×22, 4.0×39...) and Aluminum Content can be produced according to customer's request.
备注: 特殊规格的尺寸 (4.0×12, 4.0×22, 4.0×39.....) 及公差和含铝量可以按客户的要求来生产。

Specification (产品规格)

Type (瓷类)	Size (规格)
FS-25 FS-55 FS-70	1.7×5.2, 1.7×5.5, 1.7×6.0, 2.0×7.5, 2.0×8.0, 2.5×8.0, 3.0×8.0, 3.5×10, 4.0×14, 5.0×16, 7.0×23
FS-75 FS-80	1.3×2.7, 1.7×5.2, 1.7×5.5, 1.7×6.0, 2.0×7.5, 2.0×8.0, 2.5×8.0, 3.0×8.0, 3.5×10, 4.0×14, 5.0×16, 7.0×23
FS-85 RS-92 FS-98	1.3×2.7, 1.7×5.2, 1.7×5.5, 1.7×6.0, 2.0×7.5, 2.0×8.0, 2.5×8.0, 3.0×8.0, 3.5×10, 4.0×14, 5.0×16, 7.0×23

Ordering Procedure (Example:OPD217520000FS)

订购方式 (例如: 膜层用 1.7×5.2 80% 瓷棒)



Remark: can produce other Alumina content product according to customer's request.
备注: 可根据客户的要求订制其他含铝量的产品.



Feature (特性)

- Aluminum Content 70%, 80%, 85% (70%, 80%, 85% 含铝量白瓷棒)
- Electronic Ceramic parts in superior performance (属于优良电子陶瓷产品)
- Suitable for producing in different types of Wire-wound resistors (适合生产绕线电阻)



1. Ceramic (瓷棒)
2. Cap (iron) (铁帽. 铁)
3. Cap (copper) (铁帽. 铜层)
4. Cap (tin) (铁帽. 锡层)

Dimension (尺寸) (单位: mm)

NO	Size 规格	Capped Ceramic Rod 压帽瓷棒		MIN PULLING FORCE 最小拉力 (KG)
		D 直径	L 长度	
1	1.3×2.7	1.54~1.66	2.86~3.16	2
2	1.7×5.2	2.03~2.17	5.36~5.76	3
3	1.7×5.5	2.03~2.17	5.66~6.16	3
4	1.7×6.0	2.03~2.17	6.16~6.66	3
5	2.0×7.5	2.33~2.58	7.66~8.27	5
6	2.0×8.0	2.33~2.57	8.16~8.77	5
7	2.5×8.0	2.82~3.08	8.16~8.77	6
8	3.0×8.0	3.32~3.58	8.16~8.77	6
9	3.0×10	3.32~3.58	10.06~10.89	6
10	3.5×10	3.81~4.08	10.06~10.89	6
11	4.0×14	4.31~4.59	14.06~14.89	6
12	5.0×16	5.41~5.59	16.16~16.89	6
13	7.0×23	7.39~7.61	22.96~24.09	6

Ordering Procedure (Example: OSC14014000000)

订购方式 (例如 :4.0×14 规格 70% 组帽瓷棒)

O S C 1 4 0 1 4 0 0 0 0 0 0

Product Name
表示品名:
OS= Ceramic Rod for
Wire-wound
绕线用瓷棒

Type 表示类别:
C= Capped Ceramic Rod 组帽

Alumina Content
表示瓷棒含铝量:
1=Alumina (含铝量) 70%
2=Alumina (含铝量) 80%
3=Alumina (含铝量) 85%
4=Alumina (含铝量) 25%
5=Alumina (含铝量) 55%
6=Alumina (含铝量) 75%
7=Alumina (含铝量) 92%
8=Alumina (含铝量) 98%

Size of Rod 表示瓷棒规格:
1327=1.3×2.7 1752=1.7×5.2
1755=1.7×5.5 1760=1.7×6.0
2075=2.0×7.5 2080=2.0×8.0
2580=2.5×8.0 3080=3.0×8.0
3010=3.0×10 3510=3.5×10
4014=4.0×14 5016=5.0×16
7023=7.0×23

0=Standard 标准品

Remark: can produce other Alumina content product according to customer's request.
备注: 可根据客户的要求订制其他含铝量的产品。

Type 膜层类型	Characteristic 膜层特点	Resistance range 电阻值范围 (Ω)	T.C.R. 电阻温度系数 (ppm/°C)	Limit of short time over load 短时间过载变化率
Film ceramic rods of carbon film resistor 碳膜	Conductive film made of high-heat temperature decompose carbon material 高温热分解碳质导电膜层	1Ω ~2.5Ω	±300	≤ (1%+0.05Ω)
	Ceramic rod with high-conduction material 高导热材料基体	2.6Ω ~800Ω	±450	
	Low cost 低成本	801Ω ~5KΩ	0 ~ -700	
		5.1KΩ ~ 120KΩ	0 ~ -1500	
Film ceramic rods of metal film resistor 金属膜	Vacuum sputtering film ceramic rod adopted 采用真空溅射完成膜层	0.5Ω ~20KΩ	±15	≤ (0.5%+0.05Ω)
	Ceramic rod with high-conduction material 高导热材料基体		±25	
	Low current noise & T.C.R. 低电流噪声、低电阻温度系数		±50	
	Wide resistance range:1Ω ~20KΩ 电阻值范围可达 :1Ω ~20KΩ			
Film ceramic rods of metal oxide film resistor 金属氧化膜	Conductive film made of metal oxide fired at high temperature 金属氧化物高温烧成膜层	2Ω ~500Ω	±350	Normal size 正常尺寸
	Good overload capacity 具有高温负荷能力			≤ (1%+0.05Ω)
	Ceramic rod with high-conduction material 高导热材料基体			Small size 小尺寸 ≤ (2%+0.05Ω)
Film ceramic rods of Chemical Deposited Film resistors 化学沉积膜	Conductive film made of chemical plated metal 化学镀金属导电膜层	0.02Ω ~1.3Ω	±200	Normal size 正常尺寸
	Ceramic rod with high-conduction material 高导热材料基体			≤ (1%+0.05Ω)
	Low cost 低成本			Small size 小尺寸 ≤ (2%+0.05Ω)
Film ceramic rods of Metal Glaze film resistors 玻璃釉膜	Conductive film made of high temperature 高温烧成贵金属氧化物导电膜层	15Ω ~1.3MΩ	±100 ±200	≤ (1%+0.05Ω)
	With high overload capacity 具有高过负荷能力			
	Wide resistance range:15Ω ~2.5MΩ 阻值范围 :15Ω ~2.5MΩ			
	Small T.C.R.: ±100~200ppm/°C 温度系数小 :±100~200ppm/°C			
0Ω resistors 零欧电阻	Conductive film made of chemical plated copper 化学镀铜导电膜层	≤ 50mΩ	/	/
	Ceramic rod with high-conduction material 高导热材料基体			
	Low cost 低成本			



Feature (特性)

- Filming in CVD technology (采用 CVD 技术成膜)
- Low cost, good performance at High Frequency (低成本, 高频特性好)
- Wide IRV range, can be sorted accurately (初值范围宽, 并可以精准分类)



1. Ceramic (瓷棒)
2. Film (膜层)
3. Cap (iron) (铁帽. 铁)
4. Cap (copper) (铁帽. 铜层)
5. Cap (tin) (铁帽. 锡层)

Dimension (尺寸) (单位: mm)

NO	Size 规格	Uncapped Filming Rod 着膜棒		Capped Filming Rod 组成品		MIN PULLING FORCE 最小拉力 (KG)
		D 直径	L 长度	D 直径	L 长度	
1	1.3×2.7	1.30±0.02	2.7±0.1	1.54~1.66	2.86~3.16	2
2	1.7×5.2	1.70±0.03	5.2 ^{+0.1} _{-0.2}	2.03~2.17	5.36~5.76	3
3	1.7×5.5	1.70±0.03	5.5±0.2	2.03~2.17	5.66~6.16	3
4	1.7×6.0	1.70±0.03	6.0±0.2	2.03~2.17	6.16~6.66	3
5	2.0×7.5	2.00 ^{+0.04} _{-0.03}	7.5±0.2	2.33~2.58	7.66~8.27	5
6	2.0×8.0	2.00±0.03	8.0±0.2	2.33~2.57	8.16~8.77	5
7	2.5×8.0	2.50±0.04	8.0±0.2	2.82~3.08	8.16~8.77	6
8	3.0×8.0	3.00±0.04	8.0±0.2	3.32~3.58	8.16~8.77	6
9	3.0×10	3.00±0.04	10.0±0.3	3.32~3.58	10.06~10.89	6
10	3.5×10	3.50 ^{+0.04} _{-0.05}	10.0±0.3	3.81~4.08	10.06~10.89	6
11	4.0×14	4.00±0.05	14.0±0.3	4.31~4.59	14.06~14.89	6
12	5.0×16	5.00±0.05	16.0±0.3	5.41~5.59	16.16~16.89	6
13	7.0×23	7.00±0.07	23.0±0.5	7.39~7.61	22.96~24.09	6

IRV (Initial Resistance Value) Range (初值范围)

1Ω-2Ω	8Ω-13Ω	60Ω-100Ω	500Ω-800Ω	4KΩ-7KΩ	30KΩ-60KΩ
1.5Ω-2.5Ω	10Ω-20Ω	80Ω-130Ω	600Ω-900Ω	5KΩ-10KΩ	40KΩ-80KΩ
2Ω-3.5Ω	15Ω-25Ω	100Ω-200Ω	800Ω-1.3KΩ	6KΩ-12KΩ	50KΩ-100KΩ
3Ω-5Ω	20Ω-30Ω	150Ω-250Ω	1KΩ-2KΩ	8KΩ-16KΩ	60KΩ-120KΩ
4Ω-7Ω	30Ω-50Ω	200Ω-400Ω	1.5KΩ-2.5KΩ	10KΩ-20KΩ	
5Ω-8Ω	40Ω-60Ω	300Ω-500Ω	2KΩ-4KΩ	15KΩ-30KΩ	
6Ω-10Ω	50Ω-80Ω	400Ω-600Ω	3KΩ-5KΩ	20KΩ-40KΩ	

Ordering Procedure (Example: CRC11752100200)

订购方式 (例如: CR 70% 1.7×5.2 10-20E)





Feature (特性)

- Filming in PCD technology. (采用 PCD 成膜技术).
- Excellent Temperature coefficient, very low current noise. (温度系数范围低, 电流噪声小).
- Wide IRV range, suitable to produce high precision product. (初值范围宽, 适用于生产高精度产品)

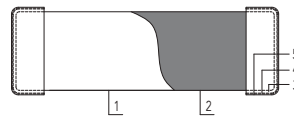

1. Ceramic (瓷棒)
2. Film (膜层)
3. Cap (iron) (铁帽. 铁)
4. Cap (copper) (铁帽. 铜层)
5. Cap (tin) (铁帽. 锡层)

Dimension (尺寸) (单位: mm)

NO	Size 规格	Uncapped Filming Rod 着膜棒		Capped Filming Rod 组成品		MIN PULLING FORCE 最小拉力 (KG)
		D 直径	L 长度	D 直径	L 长度	
1	1.3x2.7	1.30±0.02	2.7±0.1	1.54~1.66	2.86~3.16	2
2	1.7x5.2	1.70±0.03	5.2 ^{+0.1} _{-0.2}	2.03~2.17	5.36~5.76	3
3	1.7x5.5	1.70±0.03	5.5±0.2	2.03~2.17	5.66~6.16	3
4	1.7x6.0	1.70±0.03	6.0±0.2	2.03~2.17	6.16~6.66	3
5	2.0x7.5	2.00 ^{+0.04} _{-0.03}	7.5±0.2	2.33~2.58	7.66~8.27	5
6	2.0x8.0	2.00±0.03	8.0±0.2	2.33~2.57	8.16~8.77	5
7	2.5x8.0	2.50±0.04	8.0±0.2	2.82~3.08	8.16~8.77	6
8	3.0x8.0	3.00±0.04	8.0±0.2	3.32~3.58	8.16~8.77	6
9	3.0x10	3.00±0.04	10.0±0.3	3.32~3.58	10.06~10.89	6
10	3.5x10	3.50 ^{+0.04} _{-0.05}	10.0±0.3	3.81~4.08	10.06~10.89	6
11	4.0x14	4.00±0.05	14.0±0.3	4.31~4.59	14.06~14.89	6
12	5.0x16	5.00±0.05	16.0±0.3	5.41~5.59	16.16~16.89	6
13	7.0x23	7.00±0.07	23.0±0.5	7.39~7.61	22.96~24.09	6

IRV (Initial Resistance Value) Range (初值范围)

0.5Ω-0.8Ω	4Ω-7Ω	20Ω-30Ω	100Ω-200Ω	600Ω-900Ω	4KΩ-7KΩ
0.8Ω-1.3Ω	5Ω-8Ω	30Ω-50Ω	150Ω-250Ω	800Ω-1.3KΩ	5KΩ-10KΩ
1Ω-2Ω	6Ω-10Ω	40Ω-60Ω	200Ω-400Ω	1KΩ-2KΩ	6KΩ-12KΩ
1.5Ω-2.5Ω	8Ω-13Ω	50Ω-80Ω	300Ω-500Ω	1.5KΩ-2.5KΩ	8KΩ-16KΩ
2Ω-3.5Ω	10Ω-20Ω	60Ω-100Ω	400Ω-600Ω	2KΩ-4KΩ	10KΩ-20KΩ
3Ω-5Ω	15Ω-25Ω	80Ω-130Ω	500Ω-800Ω	3KΩ-5KΩ	

Ordering Procedure (Example: MFC11752 101 201)

订购方式 (例如: MF 70% 1.7×5.2 100-200Ω)





Feature (特性)

- Conductive Film Layer produced under High Temperature (高温烧成导电膜层)
- Good Performance under High Temperature environment (高温负荷能力强)
- First Choice for Power type resistor materials (功率型产品优选原料)

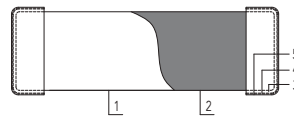

1. Ceramic (瓷棒)
2. Film (膜层)
3. Cap (iron) (铁帽, 铁)
4. Cap (copper) (铁帽, 铜层)
5. Cap (tin) (铁帽, 锡层)

Dimension (尺寸) (单位: mm)

NO	Size 规格	Uncapped Filming Rod 着膜棒		Capped Filming Rod 组成品		MIN PULLING FORCE 最小拉力 (KG)
		D 直径	L 长度	D 直径	L 长度	
1	1.3×2.7	1.30±0.02	2.7±0.1	1.54~1.66	2.86~3.16	2
2	1.7×5.2	1.70±0.03	5.2 ^{+0.1} _{-0.2}	2.03~2.17	5.36~5.76	3
3	1.7×5.5	1.70±0.03	5.5±0.2	2.03~2.17	5.66~6.16	3
4	1.7×6.0	1.70±0.03	6.0±0.2	2.03~2.17	6.16~6.66	3
5	2.0×7.5	2.00 ^{+0.04} _{-0.03}	7.5±0.2	2.33~2.58	7.66~8.27	5
6	2.0×8.0	2.00±0.03	8.0±0.2	2.33~2.57	8.16~8.77	5
7	2.5×8.0	2.50±0.04	8.0±0.2	2.82~3.08	8.16~8.77	6
8	3.0×8.0	3.00±0.04	8.0±0.2	3.32~3.58	8.16~8.77	6
9	3.0×10	3.00±0.04	10.0±0.3	3.32~3.58	10.06~10.89	6
10	3.5×10	3.50 ^{+0.04} _{-0.05}	10.0±0.3	3.81~4.08	10.06~10.89	6
11	4.0×14	4.00±0.05	14.0±0.3	4.31~4.59	14.06~14.89	6
12	5.0×16	5.00±0.05	16.0±0.3	5.41~5.59	16.16~16.89	6
13	7.0×23	7.00±0.07	23.0±0.5	7.39~7.61	22.96~24.09	6

IRV (Initial Resistance Value) Range (初值范围)

2Ω-3.5Ω	8Ω-13Ω	40Ω-60Ω	150Ω-250Ω
3Ω-5Ω	10Ω-20Ω	50Ω-80Ω	200Ω-400Ω
4Ω-7Ω	15Ω-25Ω	60Ω-100Ω	300Ω-500Ω
5Ω-8Ω	20Ω-30Ω	80Ω-130Ω	
6Ω-10Ω	30Ω-50Ω	100Ω-200Ω	

Ordering Procedure (Example: MOC11752101201)

订购方式 (例如: MO 70% 1.7×5.2 100-200Ω)





Feature (特性)

- Good performance against Humidity environment (耐湿特性好)
- Wide IRV range, can be sorted accurately (初值范围宽, 并可以精准分类)
- Best choice for Anti-surge product (抗浪涌型产品的优选原料)

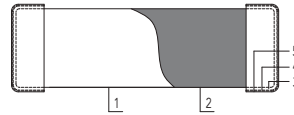

1. Ceramic (瓷棒)
2. Film (膜层)
3. Cap (iron) (铁帽, 铁)
4. Cap (copper) (铁帽, 铜层)
5. Cap (tin) (铁帽, 锡层)

Dimension (尺寸) (单位: mm)

NO	Size 规格	Uncapped Filming Rod 着膜棒		Capped Filming Rod 组成品		MIN PULLING FORCE 最小拉力 (KG)
		D 直径	L 长度	D 直径	L 长度	
1	1.3×2.7	1.30±0.02	2.7±0.1	1.54~1.67	2.86~3.16	2
2	1.7×5.2	1.70±0.03	5.2 ^{+0.1} _{-0.2}	2.03~2.18	5.36~5.76	3
3	1.7×5.5	1.70±0.03	5.5±0.2	2.03~2.18	5.66~6.16	3
4	1.7×6.0	1.70±0.03	6.0±0.2	2.03~2.18	6.16~6.66	3
5	2.0×7.5	2.00 ^{+0.04} _{-0.03}	7.5±0.2	2.33~2.73	7.66~8.27	5
6	2.0×8.0	2.00±0.03	8.0±0.2	2.33~2.60	8.16~8.77	5
7	2.5×8.0	2.50±0.04	8.0±0.2	2.82~3.11	8.16~8.77	6
8	3.0×8.0	3.00±0.04	8.0±0.2	3.32~3.60	8.16~8.77	6
9	3.0×10	3.00±0.04	10.0±0.3	3.32~3.60	10.06~10.89	6
10	3.5×10	3.50 ^{+0.04} _{-0.05}	10.0±0.3	3.81~4.10	10.06~10.89	6
11	4.0×14	4.00±0.05	14.0±0.3	4.31~4.67	14.06~14.89	6
12	5.0×16	5.00±0.05	16.0±0.3	5.41~5.62	16.16~16.89	6

IRV (Initial Resistance Value) Range (初值范围)

15Ω-25Ω	200Ω-400Ω	3KΩ-5KΩ	40KΩ-80KΩ	500KΩ-800KΩ
20Ω-30Ω	300Ω-500Ω	4KΩ-7KΩ	50KΩ-100KΩ	600KΩ-900KΩ
30ΩE-50Ω	400Ω-600Ω	5KΩ-10KΩ	60KΩ-120KΩ	800KΩ-1.3MΩ
40Ω-60Ω	500Ω-800Ω	6KΩ-12KΩ	80KΩ-160KΩ	
50Ω-80Ω	600Ω-900Ω	8KΩ-16KΩ	100KΩ-200KΩ	
60Ω-100Ω	800Ω-1.3KΩ	10KΩ-20KΩ	150KΩ-300KΩ	
80Ω-130Ω	1KΩ-2KΩ	15KΩ-30KΩ	200KΩ-400KΩ	
100Ω-200Ω	1.5KΩ-2.5KΩ	20KΩ-40KΩ	300KΩ-500KΩ	
150Ω-250Ω	2KΩ-4KΩ	30KΩ-60KΩ	400KΩ-700KΩ	

Ordering Procedure (Example: MGC32580104204)

订购方式 (例如: MG 85% 2.5×8.0 100-200KΩ)





Feature (特性)

- Conductive layer (Ni) deposited by Chemical method (化学镀镍形成导电膜层)
- Extremely Low Resistance value (超低阻值)
- Specially used for Low Resistance range product (其他膜层低阻部分的替代品)



1. Ceramic (瓷棒)
2. Film (膜层)
3. Cap (iron) (铁帽, 铁)
4. Cap (copper) (铁帽, 铜层)
5. Cap (tin) (铁帽, 锡层)

Dimension (尺寸) (单位: mm)

NO	Size 规格	Uncapped Filming Rod 着膜棒		Capped Filming Rod 组成品		MIN PULLING FORCE 最小拉力 (KG)
		D 直径	L 长度	D 直径	L 长度	
1	1.3×2.7	1.28~1.33	2.7±0.1	1.54~1.67	2.86~3.16	2
2	1.7×5.2	1.67~1.74	5.2 ^{+0.1} _{-0.2}	2.03~2.18	5.36~5.76	3
3	1.7×5.5	1.67~1.74	5.5±0.2	2.03~2.18	5.66~6.16	3
4	1.7×6.0	1.67~1.74	6.0±0.2	2.03~2.18	6.16~6.66	3
5	2.0×7.5	1.97~2.19	7.5±0.2	2.33~2.73	7.66~8.27	5
6	2.0×8.0	1.97~2.06	8.0±0.2	2.33~2.60	8.16~8.77	5
7	2.5×8.0	2.46~2.57	8.0±0.2	2.82~3.11	8.16~8.77	6
8	3.0×8.0	2.96~3.06	8.0±0.2	3.32~3.60	8.16~8.77	6
9	3.0×10	2.96~3.06	10.0±0.3	3.32~3.60	10.06~10.89	6
10	3.5×10	3.45~3.56	10.0±0.3	3.81~4.10	10.06~10.89	6
11	4.0×14	3.95~4.13	14.0±0.3	4.31~4.67	14.06~14.89	6
12	5.0×16	4.95~5.08	16.0±0.3	5.41~5.62	16.16~16.89	6
13	7.0×23	6.93~7.10	23.0±0.5	7.39~7.64	22.96~24.09	6

IRV (Initial Resistance Value) Range (初值范围)

0.02Ω-0.03Ω	0.10Ω-0.20Ω	0.80Ω-1.3Ω
0.03Ω-0.05Ω	0.20Ω-0.30Ω	1.0Ω-2.0Ω
0.05Ω-0.07Ω	0.30Ω-0.50Ω	
0.07Ω-0.10Ω	0.50Ω-0.80Ω	

Ordering Procedure (Example: CNC1401480L13K)

订购方式 (例如: CN 70% 4.0×14 0.08-0.13Ω)





Feature (特性)

- Conductive layer formed by Copper Plating (or Tin plating) process (电镀铜层或锡层作为导电膜层)
- Resistance value can be lowest to mini ohm range (阻值可低至 mΩ)
- Ceramic rod core or Alloy rod core (陶瓷棒或合金棒作为基体材料)



1. Ceramic (瓷棒)
2. Film (膜层)
3. Cap (iron) (铁帽. 铁)
4. Cap (copper) (铁帽. 铜层)
5. Cap (tin) (铁帽. 锡层)

Copper Film Ceramic Rod 镀铜瓷棒 (单位: mm)

NO	Size 规格	Copper Film Ceramic Rod 镀铜瓷棒		Copper Film Capped Ceramic Rod 镀铜组帽棒	
		D 直径	L 长度	D 直径	L 长度
1	1.3x2.7	1.30±0.02	2.7±0.1	1.60~1.70	2.89~3.14
2	1.7x5.2	1.70±0.03	5.2 ^{+0.1} _{-0.2}	2.09~2.21	5.39~5.74

Tinned Iron Rod (镀锡铁棒)



1. Fe 铁棒
2. Cu 铜层
3. Sn 锡层

Tinned Iron Rod (镀锡铁棒) (单位: mm)

NO	Size 规格	Tinned Iron Rod 镀锡铁棒	
		D 直径	L 长度
1	1.3x2.7	1.50 ± 0.05	3.00 ± 0.05
2	1.7x5.2	2.00 ± 0.05	5.60 ± 0.05

IRV (Initial Resistance Value) Range (初值范围)

Standard resistance value ≤50mE, other value or special structure can be specially provided
标准品阻值 ≤50mΩ, 其他阻值或特殊结构的要求可以特别提供

Ordering Procedure (Example: ZOC11752000000)

订购方式 (例如: ZO 70% 1.7×5.2 0Ω)



Ordering Procedure (Example: TOE01327000000)

订购方式 (例如 :0Ω 1.3×2.7 镀锡铁棒)





Feature (特性)

- Suitable for many different kinds of Electronic parts (适用各类电子产品)
- Full series in different size (规格齐全)
- Surface treatments in Tin & Copper Plating (表面经过镀铜镀锡处理)

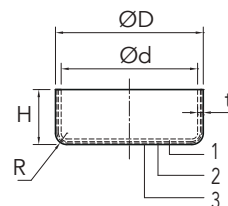

- 1. Fe 铁
- 2. Cu 铜层
- 3. Sn 锡层

Dimension (尺寸) (单位: mm)

NO	Size 规格	ØD 直径	Ød 内径	H 高度	R(Max. 最大)	t±0.02
1	1.26 × 0.95	1.62±0.02	1.265±0.02	0.95±0.02	0.15	0.15
2	1.64 × 1.42	2.10±0.02	1.64±0.02	1.42±0.04	0.20	0.20
3	1.95 × 1.74	2.51±0.02	1.93±0.02	1.74±0.03	0.25	0.25
4	1.95 × 1.85	2.51±0.02	1.93±0.02	1.85±0.03	0.25	0.25
5	2.45 × 1.95	3.00±0.02	2.44±0.02	1.95±0.05	0.25	0.25
6	2.90 × 2.00	3.50±0.03	2.92±0.02	2.00±0.05	0.25	0.25
7	2.90 × 2.10	3.50±0.03	2.92±0.02	2.10±0.05	0.25	0.25
8	3.41 × 2.35	4.00±0.03	3.41±0.02	2.35±0.05	0.25	0.25
9	3.91 × 2.35	4.50±0.03	3.91±0.03	2.35±0.05	0.25	0.25
10	4.90 × 2.85	5.48±0.02	4.88±0.03	2.85±0.05	0.25	0.25
11	6.90 × 3.45	7.50±0.02	6.90±0.03	3.45±0.05	0.25	0.25

Ordering Procedure (Example: TOCA12600000FS)

订购方式 (例如: 镀锡铁帽 Ø1.26)

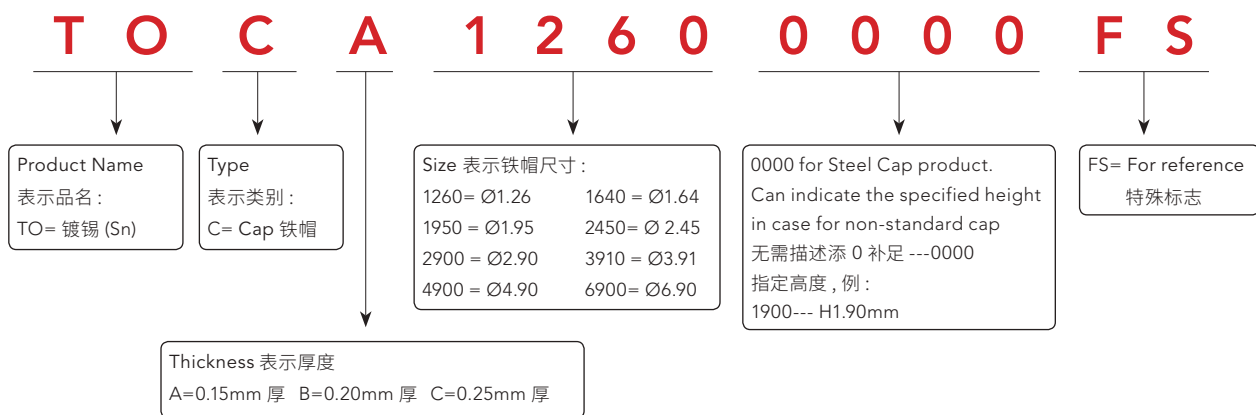

Remark: Special size can be provided according to customer's request
备注: 特殊尺寸可以按客户的要求订制



Feature (特性)

- Superior Talc Material (优质滑石瓷原料)
- Full series in different size (规格齐全)
- Hot-briquetting & Dry-pressing two different process (热压和干压两种成形方式)

Type & Dimension (类型及尺寸) (单位: mm)

Type (类型)	功率	2W	3W	5W	7W	10W	15W	20W	25W	30W	40W
	L 长	18	22	22	35	49	49	60	64	-	-
	W 宽	7	8	10	10	10	12.5	14.5	14.5	-	-
	H 高	7	8	9	9	9	11.5	13.5	13.5	-	-
	L 长	20	25	25	38	50	-	45	-	-	-
	W 宽	11.5	12.5	12.5	12.5	12.5	-	20	-	-	-
	H 高	7.5	8.5	9	9	9	-	13.5	-	-	-
	L 长	-	22	27/25	35	48	48	63	-	-	-
	W 宽	-	10	10	10	10	12.5	12.5	-	-	-
	H 高	-	9	9	9	9	11.5	13.5	-	-	-
	L 长	-	-	-	-	48	48	63	-	75	90
	W 宽	-	-	-	-	10	12.5	12.5	-	19	19
	H 高	-	-	-	-	9	11.5	13.5	-	19	19
	L 长	13 / 26	13 / 26	14 / 26	26	26	-	-	-	-	-
	W 宽	5	5	5	5	-	-	-	-	-	-
	H 高	8.5 / 9	13.5 / 13	18	20	18	-	-	-	-	-

Remark: Special type and dimension can be ordered by customer's request.
备注: 特殊尺寸可以按客户的要求订制

Performance Specifications (性能)

Item	项目	Unit 单位	Specification 标准
Bulk Density	体积密度	g/cm ³	≥ 2.8
Flexural Strength	抗折强度	MPa	139
Coefficient of Linear Thermal Expansion	线膨胀系数 (20~100°C)	×10 ⁻⁶ /°C	7.3
Permittivity	介电常数 (1MHz 20°C)	F/M	6.2
Dielectric Loss Tangent	介质损耗角正切值	×10 ⁻⁴	13
Volume Resistivity	体积电阻率 (100°C)	Ω.cm	≥ 10 ¹²
Dielectric Strength	击穿强度	K v / mm	≥ 20

Ordering Procedure (Example: CK0PRW0000500FS)

订购方式 (例如 :PRW5W 瓷壳)





Packing (标准包装方式)						
Type (类型)		Size (尺寸) (mm)			Quantity (数量) (KPCS)	
Aluminum Content (瓷棒)						
		A	B	C	袋	盒
1	1.3 × 2.7	25	20	45	600	1800
2	1.7 × 5.2	25	20	45	200	600
3	1.7 × 5.5	25	20	45	200	600
4	1.7 × 6.0	25	20	45	200	600
5	2.0 × 7.5	25	20	45	100	300
6	2.0 × 8.0	25	20	45	100	300
7	2.5 × 8.0	25	20	45	60	180
8	3.0 × 8.0	25	20	45	40	120
9	3.0 × 10	25	20	45	40	120
10	3.5 × 10	25	20	45	25	75
11	4.0 × 14	25	20	45	12.5	37.5
12	5.0 × 16	25	20	45	7.5	22.5
13	7.0 × 23	25	20	45	2.5	7.5
Capped Ceramic Rod (组帽棒)						
1	1.3 × 2.7	25	20	45	600	1800
2	1.7 × 5.2	25	20	45	200	600
3	1.7 × 5.5	25	20	45	200	600
4	1.7 × 6.0	25	20	45	200	600
5	2.0 × 7.5	25	20	45	100	300
6	2.0 × 8.0	25	20	45	100	300
7	2.5 × 8.0	25	20	45	60	180
8	3.0 × 8.0	25	20	45	40	120
9	3.0 × 10	25	20	45	40	120
10	3.5 × 10	25	20	45	25	75
11	4.0 × 14	25	20	45	12.5	37.5
12	5.0 × 16	25	20	45	7.5	22.5
13	7.0 × 23	25	20	45	2.5	7.5

Packing (标准包装方式)

Type (类型)		Size (尺寸) (mm)			Quantity (数量) (KPCS)	
Zero Ohm product (0Ω 产品)						
Copper plated 0 ohm in Ceramic core 镀铜瓷棒	1.3 × 2.7	25	20	45	600	1800
Tin plated 0 ohm in Ceramic core 镀铜瓷棒	1.7 × 5.2	25	20	45	200	600
Copper plated 0 ohm in Steel core 铁棒镀铜镀锡	1.3 × 2.7	25	20	45	300	900
Tin plated 0 ohm in Steel core 铁棒镀铜镀锡	1.7 × 5.2	25	20	45	100	300
Tin-Plated Steel Cap (铁帽)						
1	1.26 × 0.95	25	20	45	1800	5400
2	1.64 × 1.42	25	20	45	900	2700
3	1.95 × 1.85	25	20	45	600	1800
4	2.45 × 1.95	25	20	45	250	750
5	2.90 × 2.10	25	20	45	200	600
6	3.41 × 2.35	25	20	45	150	450
7	3.91 × 2.35	25	20	45	120	360
8	4.90 × 2.85	25	20	45	80	240
9	6.90 × 3.45	25	20	45	40	120



Technology Description (技术说明)

厚声采用半导体薄膜创新观念，开发直接电镀铜 (Direct Plating Copper, DPC) 陶瓷基板制程，完美的结合陶瓷散热及金属之特性。此制程利用溅镀及曝光显影方式在陶瓷基板上刻划出各种各样的电路图形，在经由电镀方式不仅可使金属与陶瓷两种不同属性之物质相互紧密结合，线路亦不易脱落 (结合力佳)。透过微显技术线路位置可更准确，线距更缩小之优点。主要应用于高亮度高功率 LED、微波无线通信、太阳能组件及半导体设备等领域。

Uni-Royal using the semiconductor thin-film innovative idea to develop the Direct Plating Copper (DPC) manufacturing process, in order to perform the excellent properties of metal and ceramic. This process developed by sputtering and exposure procedure to produce a wide variety of circuit pattern, by plating integrated the metal and ceramic properties, which the metallized metal will not be easy to peel off (good adhesion). Through this technology, the line position can be more accurately, and more narrow margin of line. Application mainly used in high brightness and high power LED, microwave radio Communication (Wireless) and semiconductor equipment, solar cell and other fields.

Thin Film Structures 薄膜结构



- ① Substrate 基板
- ② Sputter layer 溅镀层
- ③ Conductive layer 导电层
- ④ Surface Coating 表面金属层

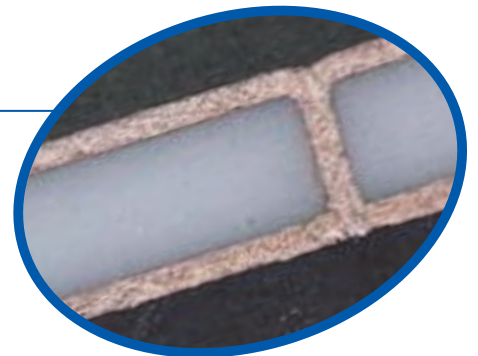

Thin Film Technology Feature (薄膜技术特征)

- ✓ 采用薄膜工艺制程获得精准的线路
- ✓ 优化的使用散热陶瓷材料特性
- ✓ 高热可靠性, 能承受 300°C 1min 热板测试
- ✓ 良好的热结合力, 可达拉力 1Kg 以上
- ✓ 优异的导通性能, 阻抗 $\leq 0.1E$
- ✓ 可按客户要求设计
- ✓ 高散热系数材料远优于 PCB 和 LTCC
- ✓ 高热稳定性远优于铝基板
- ✓ 符合 ROHS 要求
- ✓ Thin-film process to obtain accurate of line
- ✓ Optimize the best used of thermal properties of ceramic
- ✓ High reliability , withstand 300 °C within 1
- ✓ Good thermal adhesion, tensile reach > 1kg up
- ✓ Excellent conduction performance, impedance under controlled within 0.1E
- ✓ According to customer requirements, OEM available
- ✓ Highly dissipation coefficient than PCB and LTCC
- ✓ Highly heat stability superior than aluminum substrate
- ✓ ROHS compliant for global application

Process Capability 制程能力

Item 项目	Reference Range 参考范围
Material 材质	AL ₂ O ₃ 、ALN
Dimension & Thickness 尺寸厚度	Sheet size 4.5"114.3x114.3mm 0.38mm, 0.5mm, 1.0mm
Set-PIN 上机孔	Ø1、1.3、1.5、1.8、2mm Depending on the client machine 取决于客户机台
VIA diameter 导通孔径	75~150µm Depending on the customer requirement 依客户需求
Line spacing 线路间距	The smallest diameter of up to 60µm 最小线径可达 60µm
Plate margins 板边距	Sheet design set aside a minimum of 3mm 基板设计预留最小 3mm
Copper Thickness 镀层厚度	Cu 30~75µm
Surface Coating 表面处理	Electronless Gold/Silver 化学镀 (金 / 银)、Eletrolytic Gold/Silver 电镀 (金 / 银)、OSP Antioxidant treatment 抗氧化处理

Reliability Test (可靠性测试)

NO	Item 项目	Parameter 测试参数	Specification 测试规范
1	Adhesion test 附着力试验	1. Temp: RT 温度: RT 2. Tool: 3M 600# 工具: 3M 600# 3. Time adhesive 30 seconds 持续粘合 30 秒 4. Angle:180° 角度: 180°	<ul style="list-style-type: none"> • The extensor must be no separate 镀层没有被分离
2	Thermal Test 热板试验	1. Temp:300°C 温度: 300°C 2. Times:1min 时间:1 分钟	<ul style="list-style-type: none"> • No yellowing、blisters 未黄变、起泡现象
3	耐热持久性试验 Thermal durability test	1. Temp:150°C 温度: 150°C 2. Times:3 hours 时间:3 小时	<ul style="list-style-type: none"> • test before-and-after 试验前后 • 尺寸形变量 $\leq 1\%$ • Size shape variables are 1% or less • 导通阻抗恒低于 5mE • Conduction resistance constant below 5 mE

Reference Pattern (Thin-Film) 参考设计图形 (薄膜)

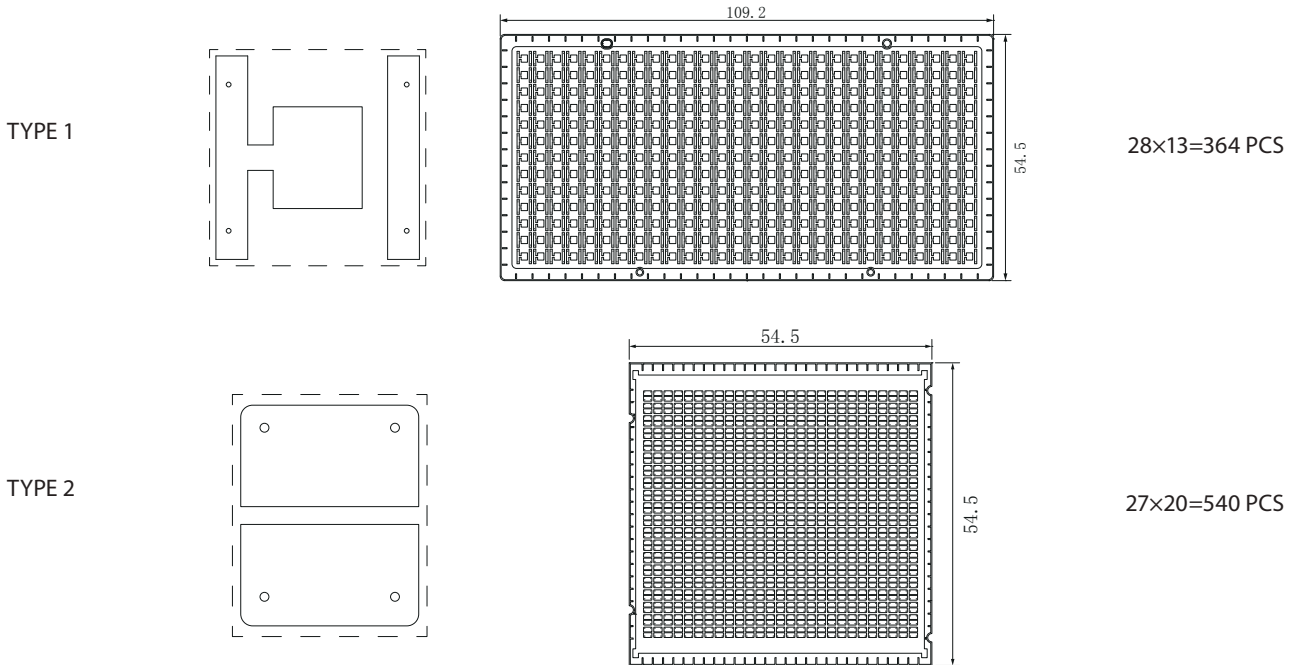

* Product drawing for reference only 产品图片仅供参考

* Custom Design Circuit could be available on a case to case basis. (可按客户特殊要求定制)

Ceramic Processing Parts (陶瓷加工件)

- ✓ 优异的加工精度
- ✓ 高绝缘性能及机械性能强度
- ✓ 客制化服务, 可按客户要求加工
- ✓ 精密研磨, 表面粗化处理等
- ✓ 适用于 LED 照明、汽车组件等产品加工

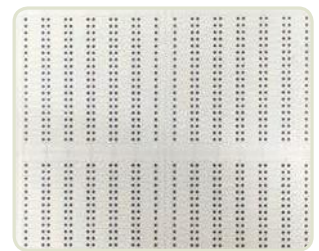
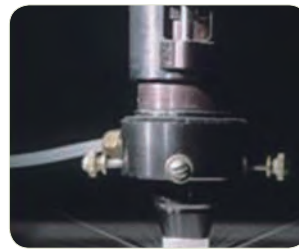

- ✓ Superior processing of accuracy
- ✓ High performance of insulation and mechanical properties
- ✓ Customized design services, OEM available
- ✓ Precision grinding, coarsening treatment of surface
- ✓ It's suitable for LED lighting, automotive components and other products processing



Storage conditions (储存条件)

- ✓ Store under 25±5°C, 50±10% RH when sealed (密封保存)
- ✓ The expiration date is less than 3 months when unsealed (不开封产品保质期在 3 个月以内)
- ✓ Store under 25±5°C, 50±10%RH when unsealed (开封产品的储存条件)
- ✓ Please store unsealed package in airtight containers and try to used within 3 days (已开封产品请于 3 日内使用完, 并在一个密闭容器内开封)

Example: Open version of 3535 model type , Alumina sheet size 4.5" (114.3x114.3x0.5mm), via hole 75μm, total thickness 0.65mm, Gold (Au) thickness ≥0.03μm

例如: 公版 1 3535 规格 氧化铝基板尺寸 4.5 寸 (114.3x114.3x0.5mm), 孔径要求 75μm 总厚要求 0.65mm 金 ≥0.03μm



Uni-Royal

厚聲集團

- 台湾总部
新竹县湖口乡新竹工业园区
- 泰国生产基地
ROYAL ELECTRONIC FACTORY (THAILAND) CO., LTD
20/1-2 Moo 2, Klong Na, Muang, Chachoengsao 24000, Thailand
Tel: +66 3882 2404 ~ 2408
Email: info@royalohm.com
- 昆山生产基地 & 销售基地
昆山厚声电子工业有限公司
中国江苏省昆山市经济技术开发区龙腾路 88 号
Tel: +86 512 5763 1411 ~ 1433
Email: localsales@uniohm.com globalsales@uniohm.com
- 厦门生产基地 & 销售基地
厦门火炬高新区翔安（产业园区）赤埔路 301 号
Tel: +86 592 708 0691
Email : sales01@aeonohm.com
- 深圳销售基地
广东省深圳市宝安区西乡镇黄麻布第二工业区 & 九围工业区
Tel: +86 755 2997 5889 Email: sales-sz@uniohm.com
Tel: +86 755 6186 1798 Email: neil@royalohm.com.cn

- 总部
- 生产基地
- 销售基地

Resistors
电阻成品

Material
电子材料

Heat Dissipation Substrate
散热基板



厚声集团 Uni-Royal Group

厚声国际贸易 (昆山) 有限公司

Uniroyal Electronics Global Co., Ltd.

中国江苏省昆山市经济技术开发区龙腾路88号

88th LongTeng Road, Economic & Technical Development Zone, Kunshan, Jiangu, China, 215 334

+86 512 5763 1400 / 1411 /1422 /1433

markering@uni-royal.cn

厚声国际贸易 (昆山) 有限公司 深圳分公司

Uniroyal Electronics Global Co., Ltd. Shenzhen Branch

中国广东省深圳市宝安区福海街道桥头社区福永街道同泰时代中心501

501, TongTai Times, Fuyong Street., Qiaotou Community, Fuhai Street, Bao'An District,

Shenzhen, Guangdong, China, 518 000

+86 755 2748 4698 Ext 6033

Info-sz@royalohm.com.cn

厚声国际贸易 (昆山) 有限公司 厦门分公司

Uniroyal Electronics Global Co., Ltd. Xiamen Branch

中国福建省厦门市火炬高新区 (翔安) 产业区赤埔路301号

301 Chi-pu Road, Xiamen Torch (Xiang'an) Industrial Zone, Xiamen, Fujian, China, 361 101

+86 592 7080 109

sales@aeonohm.com

厚声工业股份 (泰国) 有限公司

Royal Electronic Factory (Thailand) Co., Ltd.

20/1-2 Moo 2, Klong Na, Muang, Chachoengsao, Thailand 24000

+66 3882 2404 to 2408

export@royalohm.com

厚声科技股份 (泰国) 有限公司

Royal Technology (Thailand) Co., Ltd.

35 Moo.4, Don-sai, Banpho, Chachoengsao, Thailand 24140

+66 3809 0921 to 0924

info@royalohm.com

www.uni-royal.cn

X-ON Electronics

Largest Supplier of Electrical and Electronic Components

Click to view similar products for [Thick Film Resistors - SMD category](#):

Click to view products by [Uniroyal manufacturer](#):

Other Similar products are found below :

[CR-05FL7--150R](#) [CR-05FL7--698K](#) [CR-12FP4--324R](#) [CR-12JP4--680R](#) [M55342K06B10D0RS6](#) [M55342K06B14E0RS6](#)
[M55342K06B1E78RS3](#) [M55342K06B24E9RS6](#) [M55342K06B6E19RWL](#) [M55342K06B6E81RS3](#) [M55342M05B200DRWB](#)
[M55342M06B4K70MS3](#) [MC0603-511-JTW](#) [742C083750JTR](#) [MCR01MZPF1202](#) [MCR01MZPF1601](#) [MCR01MZPF1800](#)
[MCR01MZPF6201](#) [MCR01MZPF9102](#) [MCR01MZPJ113](#) [MCR01MZPJ121](#) [MCR01MZPJ125](#) [MCR01MZPJ751](#) [MCR03EZHJ103](#)
[MCR03EZPFX2004](#) [MCR03EZPJ270](#) [MCR03EZPJ821](#) [MCR10EZPF1102](#) [MCR10EZPF2700](#) [MCR18EZPJ330](#) [RC0603F1473CS](#)
[RC0603F150CS](#) [RC1005F1152CS](#) [RC1005F1182CS](#) [RC1005F1372CS](#) [RC1005F183CS](#) [RC1005F1911CS](#) [RC1005F1912CS](#)
[RC1005F203CS](#) [RC1005F2052CS](#) [RC1005F241CS](#) [RC1005F2431CS](#) [RC1005F3011CS](#) [RC1005F303CS](#) [RC1005F4321CS](#)
[RC1005F4642CS](#) [RC1005F471CS](#) [RC1005F4751CS](#) [RC1005F5621CS](#) [RC1005F6041CS](#)