



**UNI-ROYAL**  
厚聲集團

# DATA SHEET

**Product Name High-Precision Thin Film Chip Resistors**

---

**Part Name TC Series**

## **Uniroyal Electronics Global Co., Ltd.**

88#, Longteng Road, Economic & Technical Development Zone, Kunshan, Jiangsu, China

Tel +86 512 5763 1411 / 22 /33

Email [marketing@uni-royal.cn](mailto:marketing@uni-royal.cn)

Manufacture Plant Uniroyal Electronics Industry Co., Ltd.

Aeon Technology Corporation

Royal Electronic Factory (Thailand) Co., Ltd.

Royal Technology (Thailand) Co., Ltd.

**1. Scope**

- 1.1 This datasheet is the characteristics of High Precision Thin Film Chip Resistors manufactured by UNI-ROYAL.
- 1.2 Thin film NiCr Resistance element.
- 1.3 Very tight tolerance  $\pm 0.05\% \sim \pm 1\%$
- 1.4 Extremely low TCR  $\pm 5\text{ppm} \sim \pm 50\text{ppm}$
- 1.5 Completed Lead-free

**2. Explanation of Part No. System**

Part No. includes 14 codes shown as below:

2.1 1<sup>st</sup>~4<sup>th</sup> codes: Part name. E.g.:TC02, TC03, TC05, TC06, TC07, TC10, TC12

2.2 5<sup>th</sup>~6<sup>th</sup> digits:

For Thin Film Chip Resistors, these 2 digits will be used to indicate the requested Temperature Coefficient.

(1) 05=5PPM (2) 10=10PPM (3) 15=15PPM (4) 25=25PPM (5) 50=50PPM

2.3 The 7<sup>th</sup> digit is to denote the Resistance Tolerance. The following letter code is to be used for indicating the standard Resistance Tolerance.

W= $\pm 0.05\%$  L= $\pm 0.01\%$  B= $\pm 0.10\%$  C= $\pm 0.25\%$  D= $\pm 0.50\%$  F= $\pm 1.00\%$

2.4 The 8<sup>th</sup> to 11<sup>th</sup> digits is to denote the Resistance Value.

2.4.1 For the standard resistance values of TC series, the 8<sup>th</sup> digit to the 10<sup>th</sup> digits is to denote the significant figures of the resistance and the 11<sup>th</sup> digit is the zeros following.

2.4.2 The following number s and the letter codes is to be used to indicate the number of zeros in the 11<sup>th</sup> digit:

0=10<sup>0</sup> 1=10<sup>1</sup> 2=10<sup>2</sup> 3=10<sup>3</sup> 4=10<sup>4</sup> 5=10<sup>5</sup> 6=10<sup>6</sup> J=10<sup>-1</sup> K=10<sup>-2</sup> L=10<sup>-3</sup> M=10<sup>-4</sup>

2.4.3 The 12<sup>th</sup>, 13<sup>th</sup> & 14<sup>th</sup> digits.

The 12<sup>th</sup> digit is to denote the Packaging Type with the following codes:

C=Bulk T=Tape/Reel

2.4.4 The 13<sup>th</sup> digit is normally to indicate the Packing Quantity of Tape/Box & Tape/Reel packaging types. The following letter code and number is to be used for some packing quantities:

4=4000pcs 5=5000pcs C=10000pcs D=20000pcs E=15000pcs

Chip Product: BD=B/B-20000pcs TC=T/R-10000pcs

2.4.5 The 14<sup>th</sup> digit

This is to indicate the wattage or power rating:

C=1/16W; F=1/10W; G=1/8W; J=1/4W;

K=1/3W; M=1/2W; N=3/4W; S=Special

**3. Ordering Procedure**

(Example: TC06 1/4W  $\pm 0.1\%$  25PPM 1K $\Omega$  T/R-5000 )

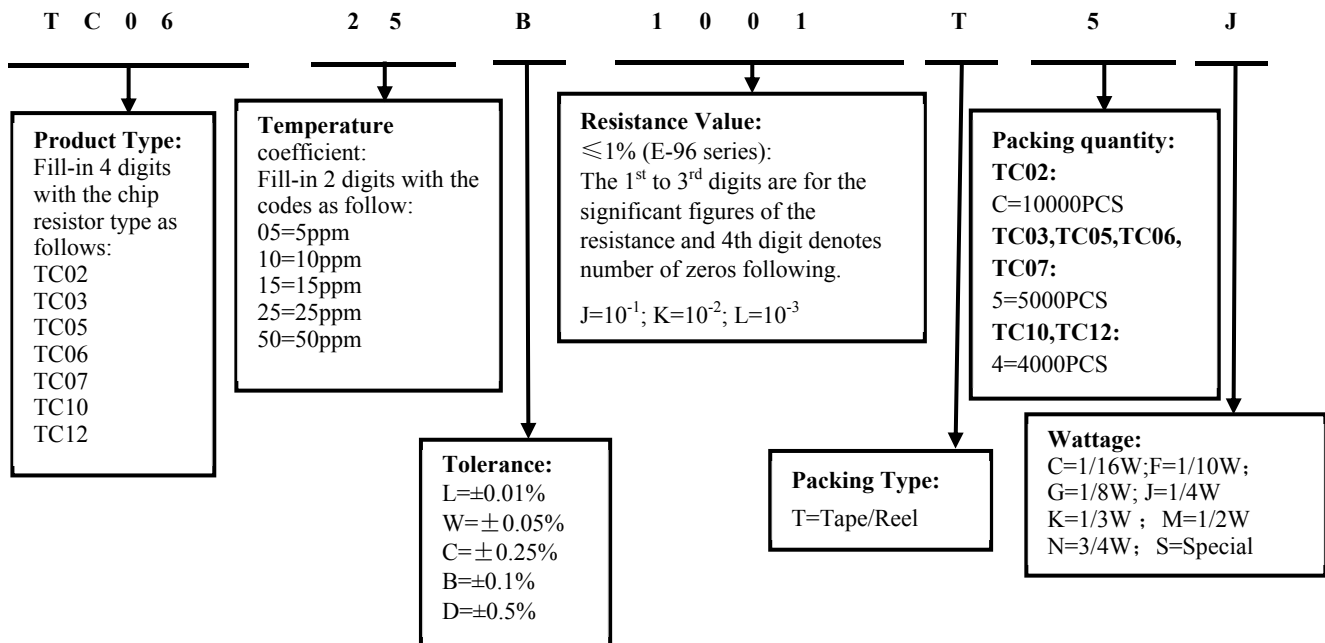

**4. Marking**

(1) For TC02 size. Due to the very TC02 small size of the resistor's body, there is no marking on the body.



(2) For TC05、TC06、TC07、TC10、TC12 size.  
±0.1%、±0.25%、±0.5%、±1% Tolerance:

4 codes.  
1<sup>st</sup>~3<sup>rd</sup> codes are the significant figures of resistance value, and the rest code is the power of ten.  
Letter "R" in mark means decimal point.



2701 → 2.7KΩ

(3) Standard E-96 series values of TC03 ≤1% : due to the small size of the resistor's body, 3 digits marking will be used to indicate the accurate resistance value by using the following multiplier & resistance code.  
Multiplier Code (for 0603 ≤±1% marking)

Code	A	B	C	D	E	F	G	H	X	Y	Z
Multiplier	10 <sup>0</sup>	10 <sup>1</sup>	10 <sup>2</sup>	10 <sup>3</sup>	10 <sup>4</sup>	10 <sup>5</sup>	10 <sup>6</sup>	10 <sup>7</sup>	10 <sup>-1</sup>	10 <sup>-2</sup>	10 <sup>-3</sup>

Standard E-96 series Resistance Value code (for 0603 ≤±1% marking)

Value	Code	Value	Code	Value	Code	Value	Code
100	01	178	25	316	49	562	73
102	02	182	26	324	50	576	74
105	03	187	27	332	51	590	75
107	04	191	28	340	52	604	76
110	05	196	29	348	53	619	77
113	06	200	30	357	54	634	78
115	07	205	31	365	55	649	79
118	08	210	32	374	56	665	80
121	09	215	33	383	57	681	81
124	10	221	34	392	58	698	82
127	11	226	35	402	59	715	83
130	12	232	36	412	60	732	84
133	13	237	37	422	61	750	85
137	14	243	38	432	62	768	86
140	15	249	39	442	63	787	87
143	16	255	40	453	64	806	88
147	17	261	41	464	65	825	89
150	18	267	42	475	66	845	90
154	19	274	43	487	67	866	91
158	20	280	44	499	68	887	92
162	21	287	45	511	69	909	93
165	22	294	46	523	70	931	94
169	23	301	47	536	71	953	95
174	24	309	48	549	72	976	96

So the resistance value are marked as the following examples



1.96KΩ=196×10<sup>1</sup>Ω=29B



12.4Ω=124×10<sup>-1</sup>Ω=10X

(4) Standard E-24 and not belong to E-96 series values (≤±1%) of TC03 size: the marking is 3 digits, the first 2 digits are the significant of the resistance and the 3rd digit denotes number of zeros following or marking as underline.



333=33KΩ



333=33KΩ

## 5. Dimension (Unit: mm)

Type	L	W	H	A	B
TC02(0402)	1.00±0.10	0.50±0.05	0.35±0.05	0.20±0.10	0.25±0.10
TC03(0603)	1.60±0.10	0.80±0.10	0.45±0.10	0.30±0.20	0.30±0.20
TC05(0805)	2.00±0.15	1.25+0.15/-0.10	0.55±0.10	0.30±0.20	0.40±0.20
TC06(1206)	3.10±0.15	1.55+0.15/-0.10	0.55±0.10	0.40±0.20	0.45±0.20
TC07(1210)	3.10±0.10	2.60±0.20	0.55±0.10	0.40±0.20	0.45±0.20
TC10(2010)	5.00±0.10	2.50±0.20	0.55±0.10	0.50±0.25	0.50±0.20
TC12(2512)	6.35±0.10	3.20±0.20	0.55±0.10	0.50±0.25	0.50±0.20



## 6. Resistance Range

Type	Power rating	Operating Temperature	Max. Working Voltage	Max. Overload Voltage	Dielectric withstanding Voltage	Resistance Range			TCR (PPM/°C)
						±0.01% ±0.05%	±0.1% ±0.25%	±0.5%	
TC02	1/16W	-55°C~155°C	25V	50V	100V	/	100Ω~2KΩ	100Ω~2KΩ	±5
						/	50Ω~12KΩ	50Ω~12KΩ	±10
						/	10Ω~332KΩ	10Ω~332KΩ	±25
						/	10Ω~332KΩ	10Ω~332KΩ	±50
TC03	1/10W	-55°C~155°C	75V	150V	300V	/	100Ω~4KΩ	100Ω~4KΩ	±5
						/	10Ω~50KΩ	10Ω~50KΩ	±10
						4.7Ω~332K	4.7Ω~1MΩ	1Ω~1MΩ	±25
						4.7Ω~332K	4.7Ω~1MΩ	1Ω~1MΩ	±50
TC05	1/8W	-55°C~155°C	150V	300V	500V	/	100Ω~15KΩ	100Ω~15KΩ	±5
						/	10Ω~100KΩ	10Ω~100KΩ	±10
						4.7Ω~511K	4.7Ω~2MΩ	1Ω~2MΩ	±25
						4.7Ω~511K	4.7Ω~2MΩ	1Ω~2MΩ	±50
TC06	1/4W	-55°C~155°C	200V	400V	500V	/	100Ω~15KΩ	100Ω~15KΩ	±5
						/	10Ω~200KΩ	10Ω~200KΩ	±10
						4.7Ω~1M	4.7Ω~3MΩ	1Ω~3MΩ	±25
						4.7Ω~1M	4.7Ω~3MΩ	1Ω~3MΩ	±50
TC07	1/3W	-55°C~155°C	200V	400V	500V	/	100Ω~15KΩ	100Ω~15KΩ	±5
						/	10Ω~200KΩ	10Ω~200KΩ	±10
						4.7Ω~1M	4.7Ω~3MΩ	1Ω~3MΩ	±25
						4.7Ω~1M	4.7Ω~3MΩ	1Ω~3MΩ	±50
TC10	1/2W	-55°C~155°C	200V	400V	500V	/	100Ω~25KΩ	100Ω~25KΩ	±5
						/	50Ω~200KΩ	50Ω~200KΩ	±10
						4.7Ω~1M	4.7Ω~3MΩ	1Ω~3MΩ	±25
						4.7Ω~1M	4.7Ω~3MΩ	1Ω~3MΩ	±50
TC12	3/4W	-55°C~155°C	200V	400V	500V	/	100Ω~25KΩ	100Ω~25KΩ	±5
						/	50Ω~200KΩ	50Ω~200KΩ	±10
						10Ω~1M	4.7Ω~3MΩ	1Ω~3MΩ	±25
						10Ω~1M	4.7Ω~3MΩ	1Ω~3MΩ	±50

**7. Soldering pad size recommended**

Type	Dimension(mm)			
	A	B	C	D
TC02	0.50±0.05	0.45±0.05	0.5±0.05	1.4±0.05
TC03	0.8±0.05	0.65±0.05	0.8±0.05	2.1±0.05
TC05	1.0±0.1	1.0±0.1	1.3±0.1	3.0±0.1
TC06	2.0±0.1	1.1±0.1	1.6±0.1	4.2±0.1
TC07	2.0±0.1	1.1±0.1	2.6±0.1	4.2±0.1
TC10	3.6±0.1	1.3±0.1	2.6±0.1	6.2±0.1
TC12	4.9±0.1	1.6±0.1	3.3±0.1	8.1±0.1



**8. Derating Curve**

Power rating will change based on continuous load at ambient temperature from -55 to 155°C. It is constant between -55 to 70°C, and derate to zero when temperature rise from 70 to 155°C.

Voltage rating:

Resistors shall have a rated direct-current (DC) continuous working voltage or an approximate sine-wave root-mean-square (RMS) alternating-current (AC) continuous working voltage at commercial-line frequency and waveform corresponding to the power rating, as determined from the following formula:

$$RCWV = \sqrt{P} \times R$$

Remark: RCWV: Rating Continuous Working Voltage (Volt.) P: power rating (Watt) R: nominal resistance (Ω)

In no case shall the rated DC or RMS AC continuous working voltage be greater than the applicable maximum value. The overload voltage is 2.5 times RCWV or Max. Overload voltage whichever is lower.

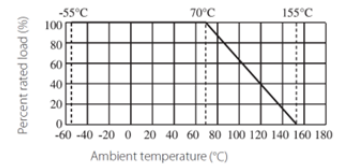

**9. Structure**

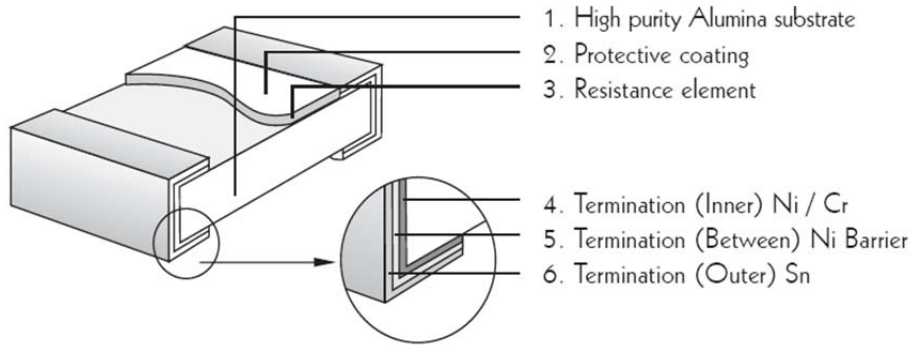

**10. Performance Specification**

Characteristic	Limits	Test Method (GB/T5729&JIS-C-5201&IEC60115-1)
Temperature Coefficient	Refer to item 6.0	4.8 Natural resistance changes per temp. Degree centigrade $\frac{R_2 - R_1}{R_1(t_2 - t_1)} \times 10^6 \text{ (PPM/°C)}$ R <sub>1</sub> : Resistance Value at room temperature (t <sub>1</sub> ) ; R <sub>2</sub> : Resistance at test temperature (Upper limit temperature or Lower limit temperature) t <sub>1</sub> : +25°C or specified room temperature t <sub>2</sub> : Upper limit temperature or Lower limit temperature test temperature
Short-time overload	ΔR ≤ ±0.5%	4.13 Permanent resistance change after the application of a potential of 2.5 times RCWV or Max. Overload Voltage whichever less for 5 seconds..
Insulation resistance	≥ 1000MΩ	4.6 The measuring voltage shall be measured with a direct voltage of (100±15)V or a voltage equal to the dielectric withstanding voltage., and apply for 1min

Load life	$\Delta R \leq \pm 0.5\%$	4.25 Permanent resistance change after 1,000 hours operating at RCWV with duty cycle 1.5 hours "ON", 0.5 hour "OFF" at 70°C $\pm 2^\circ\text{C}$ ambient.
Humidity	$\Delta R \leq 0.3\%$	4.24 Temporary resistance change after 240 hours exposure in a humidity test chamber controlled at 40 $\pm 2^\circ\text{C}$ and 90-95% relative humidity,
Terminal bending	$\Delta R \leq \pm 0.2\%$	4.33 Twist of test board: Y/X = 3/90 mm for 60Seconds
Solderability	95% coverage min.	4.17 The area covered with a new, smooth, clean, shiny and continuous surface free from concentrated pinholes. Temperature of solder: 245 $\pm 3^\circ\text{C}$ ; Dwell time in solder: 2~3 seconds.
Soldering heat	$\Delta R \leq \pm 0.2\%$	4.18 Dip the resistor into a solder bath having a temperature of 260 $\pm 5^\circ\text{C}$ and hold it for 10 $\pm 1$ seconds.
Load life in humidity	$\Delta R \leq \pm 0.5\%$	7.9 Resistance change after 1,000 hours (1.5 hours "ON", 0.5 hour "OFF") at RCWV in a humidity chamber controlled at 40 $\pm 2^\circ\text{C}$ and 90 to 95% relative humidity.
Low Temperature Storage	$\Delta R \leq \pm 0.5\%$	IEC 60068-2-1(Aa) Lower limit temperature , for 2H.
High Temperature Exposure	$\Delta R \leq \pm 0.5\%$	MIL-STD-202 108A Upper limit temperature , for 1000H.
Leaching	No visible damage	J-STD-002 Test D Samples completely immersed for 30 sec in solder bath at 260 $\pm 5^\circ\text{C}$ .
Rapid change of temperature	$\Delta R \leq \pm 0.5\%$	4.19 30 min at lower limit temperature and 30 min at upper limit temperature , 100 cycles.

11. Soldering Condition

(This is for recommendation, please customer perform adjustment according to actual application)

11.1 Recommend Reflow Soldering Profile : (solder : Sn96.5 / Ag3 / Cu0.5)

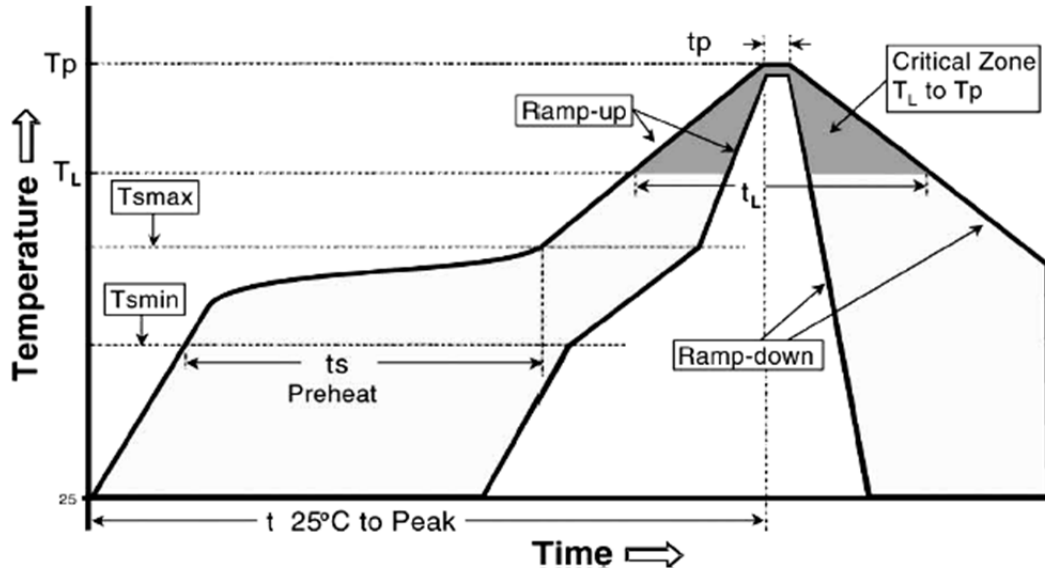

Profile Feature	Lead (Pb)-Free solder
Preheat: Temperature Min ( $T_{s_{min}}$ ) Temperature Max ( $T_{s_{max}}$ ) Time ( $T_{s_{min}}$ to $T_{s_{max}}$ ) ( $t_s$ )	150°C 200°C 60 -120seconds
Average ramp-up rate: ( $T_{s_{max}}$ to $T_p$ )	3°C / second max.
Time maintained above : Temperature ( $T_L$ ) Time ( $t_L$ )	217°C 60-150 seconds
Peak Temperature ( $T_p$ )	260°C
Time within $+0/-5$ °C of actual peak Temperature ( $t_p$ ) <sup>2</sup>	10 seconds
Ramp-down Rate	6°C/second max.
Time 25°C to Peak Temperature	8minutes max.

Allowed Re-flow times : 2 times

Remark : To avoid discoloration phenomena of chip on terminal electrodes, please use N<sub>2</sub> Re-flow furnace .

11.2 Recommend Wave Soldering Profile : (Apply to 0603 and above size)





**12. Packing**

12.1 Dimension of Paper Taping :(Unit: mm)

Type	A ±0.10	B ±0.10	C ±0.05	$\Phi D_{-0}^{+0.1}$	E ±0.1	F ±0.05	G ±0.1	W ±0.2	T ±0.05
TC02	0.65	1.20	2.00	1.50	1.75	3.50	4.00	8.00	0.42



Type	A ±0.2	B ±0.2	C ±0.05	$\Phi D_{-0}^{+0.1}$	E ±0.1	F ±0.05	G ±0.1	W ±0.2	T ±0.1
TC03	1.10	1.90	2.00	1.50	1.75	3.50	4.00	8.00	0.67
TC05	1.65	2.40	2.00	1.50	1.75	3.50	4.00	8.00	0.81
TC06	2.00	3.60	2.00	1.50	1.75	3.50	4.00	8.00	0.81
TC07	2.80	3.50	2.00	1.50	1.75	3.50	4.00	8.00	0.75

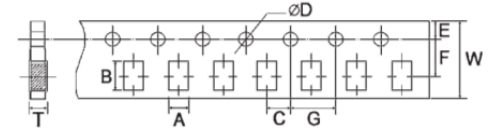

12.2 Dimension of plastic taping:(Unit: mm)

Type	A ±0.2	B ±0.2	C ±0.05	$\Phi D_{-0}^{+0.1}$	$\Phi D1_{-0}^{+0.25}$	E ±0.1	F ±0.05	G ±0.1	W ±0.2	T ±0.1
TC10	2.90	5.60	2.00	1.50	1.50	1.75	5.50	4.00	12.00	1.00
TC12	3.50	6.70	2.00	1.50	1.50	1.75	5.50	4.00	12.00	1.00

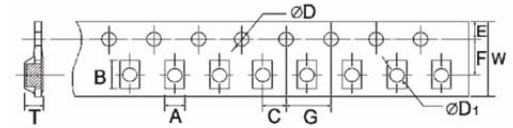

12.3 Dimension of Reel :(Unit: mm)

Type	Taping	Qty/Reel	A ±0.5	B ±0.5	C ±0.5	D ±1	M ±2	W ±1
TC02	Paper	10,000pcs	2.0	13.0	21.0	60.0	178.0	10.0
TC03	Paper	5,000pcs	2.0	13.0	21.0	60.0	178.0	10.0
TC05	Paper	5,000pcs	2.0	13.0	21.0	60.0	178.0	10.0
TC06	Paper	5,000pcs	2.0	13.0	21.0	60.0	178.0	10.0
TC07	Paper	5,000pcs	2.0	13.0	21.0	60.0	178.0	10.0
TC10	Embossed	4,000pcs	2.0	13.0	21.0	60.0	178.0	13.8
TC12	Embossed	4,000pcs	2.0	13.0	21.0	60.0	178.0	13.8

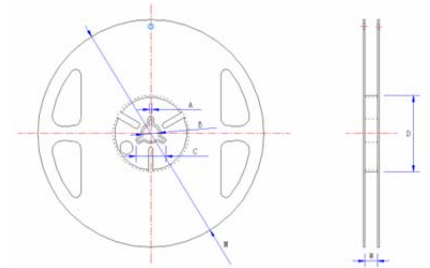

**13. Note**

- 13.1. UNI-ROYAL recommend products store in warehouse with temperature between 15 to 35°C under humidity between 25 to 75%RH. Even under storage conditions recommended above, solder ability of products will be degraded stored over 1 year old.
- 13.2. Cartons must be placed in correct direction which indicated on carton, otherwise the reel or wire will be deformed.
- 13.3. Storage conditions as below are inappropriate:
  - a. Stored in high electrostatic environment
  - b. Stored in direct sunshine, rain, snow or condensation.
  - c. Exposed to sea wind or corrosive gases, such as Cl<sub>2</sub>, H<sub>2</sub>S, NH<sub>3</sub>, SO<sub>2</sub>, NO<sub>2</sub>, etc.
- 13.4 After the surface of TC series high resistance resistors is coated with flux, the resistance value may be affected (exceeding the resistance value range). After the customer's evaluation, if necessary, corresponding cleaning measures can be taken to restore the resistance. In addition, if the surface of the resistor needs to be coated with other substances, the client needs to evaluate the impact on the product to avoid any impact during use.



## 14. Record

Version	Description	Page	Date	Amended by	Checked by
1	First version	1~7	Mar.20, 2018	Haiyan Chen	Nana Chen
2	1. Modify the power 2. Modify the resistance range	3	Mar.14, 2019	Haiyan Chen	Yuhua Xu
3	Modify the dimension of A face value	3	Apr.23, 2019	Haiyan Chen	Yuhua Xu
4	Modify the High Temperature Exposure conditions	5	July.29, 2019	Haiyan Chen	Yuhua Xu
5	Add Tolerance	2~ 3	Apr.15,2020	Haiyan Chen	Yuhua Xu
6	Modify the reflow curve and add the wave soldering curve	6	Apr.29, 2020	Haiyan Chen	Yuhua Xu
7	Add the TC03 marking	3	Jan.14, 2021	Haiyan Chen	Yuhua Xu
8	Modify the test limits for Load life 、 Low Temperature Storage 、 High Temperature Exposure and Rapid change of temperature	6	Jan.20,2021	Song Nie	Yuhua Xu
9	Add the 13.4	8	Jul.12,2021	Haiyan Chen	John Zhao

© Uniroyal Electronics Global Co., Ltd. All rights reserved. Specification herein will be changed at any time without prior notice.

## X-ON Electronics

Largest Supplier of Electrical and Electronic Components

*Click to view similar products for [Thick Film Resistors - SMD category](#):*

*Click to view products by [Uniroyal manufacturer](#):*

Other Similar products are found below :

[CR-05FL7--150R](#) [CR-05FL7--698K](#) [CR-12FP4--324R](#) [CR-12JP4--680R](#) [M55342K06B10D0RS6](#) [M55342K06B14E0RS6](#)  
[M55342K06B1E78RS3](#) [M55342K06B24E9RS6](#) [M55342K06B6E19RWL](#) [M55342K06B6E81RS3](#) [M55342M05B200DRWB](#)  
[M55342M06B4K70MS3](#) [MC0603-511-JTW](#) [742C083750JTR](#) [MCR01MZPF1202](#) [MCR01MZPF1601](#) [MCR01MZPF1800](#)  
[MCR01MZPF6201](#) [MCR01MZPF9102](#) [MCR01MZPJ113](#) [MCR01MZPJ121](#) [MCR01MZPJ125](#) [MCR01MZPJ751](#) [MCR03EZHJ103](#)  
[MCR03EZPF2004](#) [MCR03EZPJ270](#) [MCR03EZPJ821](#) [MCR10EZPF1102](#) [MCR10EZPF2700](#) [MCR18EZPJ330](#) [RC1005F1152CS](#)  
[RC1005F1182CS](#) [RC1005F1372CS](#) [RC1005F183CS](#) [RC1005F1911CS](#) [RC1005F1912CS](#) [RC1005F203CS](#) [RC1005F2052CS](#)  
[RC1005F241CS](#) [RC1005F2431CS](#) [RC1005F3011CS](#) [RC1005F303CS](#) [RC1005F4321CS](#) [RC1005F4642CS](#) [RC1005F471CS](#)  
[RC1005F4751CS](#) [RC1005F5621CS](#) [RC1005F6041CS](#) [RC1005J106CS](#) [RC1005J121CS](#)