

UNI-ROYAL
厚聲集團

DATA SHEET

Product Name High-Precision Thin Film Chip Resistors

Part Name TC Series

Uniroyal Electronics Global Co., Ltd.

88#, Longteng Road, Economic & Technical Development Zone, Kunshan, Jiangsu, China

Tel +86 512 5763 1411 / 22 /33

Email marketing@uni-royal.cn

Manufacture Plant Uniroyal Electronics Industry Co., Ltd.

Aeon Technology Corporation

Royal Electronic Factory (Thailand) Co., Ltd.

Royal Technology (Thailand) Co., Ltd.

1. Scope

- 1.1 This datasheet is the characteristics of High Precision Thin Film Chip Resistors manufactured by UNI-ROYAL.
- 1.2 Thin film NiCr Resistance element.
- 1.3 Very tight tolerance $\pm 0.05\% \sim \pm 1\%$
- 1.4 Extremely low TCR $\pm 5\text{ppm} \sim \pm 50\text{ppm}$
- 1.5 Completed Lead-free

2. Explanation of Part No. System

Part No. includes 14 codes shown as below:

2.1 1st~4th codes: Part name. E.g.:TC02, TC03, TC05, TC06, TC07, TC10, TC12

2.2 5th~6th digits:

For Thin Film Chip Resistors, these 2 digits will be used to indicate the requested Temperature Coefficient.

(1) 05=5PPM (2) 10=10PPM (3) 15=15PPM (4) 25=25PPM (5) 50=50PPM

2.3 The 7th digit is to denote the Resistance Tolerance. The following letter code is to be used for indicating the standard Resistance Tolerance.

W= $\pm 0.05\%$ L= $\pm 0.01\%$ B= $\pm 0.10\%$ C= $\pm 0.25\%$ D= $\pm 0.50\%$ F= $\pm 1.00\%$

2.4 The 8th to 11th digits is to denote the Resistance Value.

2.4.1 For the standard resistance values of TC series, the 8th digit to the 10th digits is to denote the significant figures of the resistance and the 11th digit is the zeros following.

2.4.2 The following number s and the letter codes is to be used to indicate the number of zeros in the 11th digit:

0=10⁰ 1=10¹ 2=10² 3=10³ 4=10⁴ 5=10⁵ 6=10⁶ J=10⁻¹ K=10⁻² L=10⁻³ M=10⁻⁴

2.4.3 The 12th, 13th & 14th digits.

The 12th digit is to denote the Packaging Type with the following codes:

C=Bulk T=Tape/Reel

2.4.4 The 13th digit is normally to indicate the Packing Quantity of Tape/Box & Tape/Reel packaging types. The following letter code and number is to be used for some packing quantities:

4=4000pcs 5=5000pcs C=10000pcs D=20000pcs E=15000pcs

Chip Product: BD=B/B-20000pcs TC=T/R-10000pcs

2.4.5 The 14th digit

This is to indicate the wattage or power rating:

C=1/16W; F=1/10W; G=1/8W; J=1/4W;

K=1/3W; M=1/2W; N=3/4W; S=Special

3. Ordering Procedure

(Example: TC06 1/4W $\pm 0.1\%$ 25PPM 1K Ω T/R-5000)

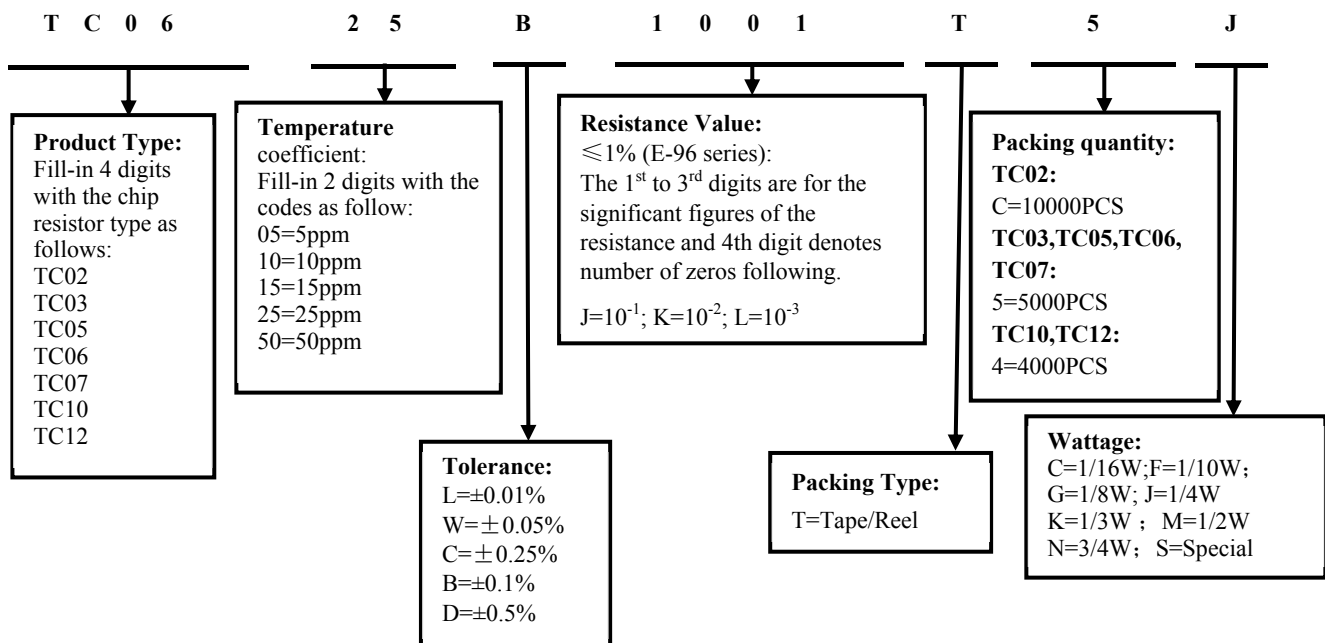

4. Marking

(1) For TC02 size. Due to the very TC02 small size of the resistor's body, there is no marking on the body.



(2) For TC05、TC06、TC07、TC10、TC12 size.
±0.1%、±0.25%、±0.5%、±1% Tolerance:

4 codes.
1st~3rd codes are the significant figures of resistance value, and the rest code is the power of ten.
Letter "R" in mark means decimal point.



2701 → 2.7KΩ

(3) Standard E-96 series values of TC03 ≤ 1% : due to the small size of the resistor's body, 3 digits marking will be used to indicate the accurate resistance value by using the following multiplier & resistance code.
Multiplier Code (for 0603 ≤ ±1% marking)

| Code | A | B | C | D | E | F | G | H | X | Y | Z |
|------------|-----------------|-----------------|-----------------|-----------------|-----------------|-----------------|-----------------|-----------------|------------------|------------------|------------------|
| Multiplier | 10 ⁰ | 10 ¹ | 10 ² | 10 ³ | 10 ⁴ | 10 ⁵ | 10 ⁶ | 10 ⁷ | 10 ⁻¹ | 10 ⁻² | 10 ⁻³ |

Standard E-96 series Resistance Value code (for 0603 ≤ ±1% marking)

| Value | Code | Value | Code | Value | Code | Value | Code |
|-------|------|-------|------|-------|------|-------|------|
| 100 | 01 | 178 | 25 | 316 | 49 | 562 | 73 |
| 102 | 02 | 182 | 26 | 324 | 50 | 576 | 74 |
| 105 | 03 | 187 | 27 | 332 | 51 | 590 | 75 |
| 107 | 04 | 191 | 28 | 340 | 52 | 604 | 76 |
| 110 | 05 | 196 | 29 | 348 | 53 | 619 | 77 |
| 113 | 06 | 200 | 30 | 357 | 54 | 634 | 78 |
| 115 | 07 | 205 | 31 | 365 | 55 | 649 | 79 |
| 118 | 08 | 210 | 32 | 374 | 56 | 665 | 80 |
| 121 | 09 | 215 | 33 | 383 | 57 | 681 | 81 |
| 124 | 10 | 221 | 34 | 392 | 58 | 698 | 82 |
| 127 | 11 | 226 | 35 | 402 | 59 | 715 | 83 |
| 130 | 12 | 232 | 36 | 412 | 60 | 732 | 84 |
| 133 | 13 | 237 | 37 | 422 | 61 | 750 | 85 |
| 137 | 14 | 243 | 38 | 432 | 62 | 768 | 86 |
| 140 | 15 | 249 | 39 | 442 | 63 | 787 | 87 |
| 143 | 16 | 255 | 40 | 453 | 64 | 806 | 88 |
| 147 | 17 | 261 | 41 | 464 | 65 | 825 | 89 |
| 150 | 18 | 267 | 42 | 475 | 66 | 845 | 90 |
| 154 | 19 | 274 | 43 | 487 | 67 | 866 | 91 |
| 158 | 20 | 280 | 44 | 499 | 68 | 887 | 92 |
| 162 | 21 | 287 | 45 | 511 | 69 | 909 | 93 |
| 165 | 22 | 294 | 46 | 523 | 70 | 931 | 94 |
| 169 | 23 | 301 | 47 | 536 | 71 | 953 | 95 |
| 174 | 24 | 309 | 48 | 549 | 72 | 976 | 96 |

So the resistance value are marked as the following examples



1.96KΩ = 196 × 10¹Ω = 29B



12.4Ω = 124 × 10⁻¹Ω = 10X

(4) Standard E-24 and not belong to E-96 series values (≤ ±1%) of TC03 size: the marking is 3 digits, the first 2 digits are the significant of the resistance and the 3rd digit denotes number of zeros following or marking as underline.



333 = 33KΩ



333 = 33KΩ

5. Dimension (Unit: mm)

| Type | L | W | H | A | B |
|------------|-----------|-----------------|-----------|-----------|-----------|
| TC02(0402) | 1.00±0.10 | 0.50±0.05 | 0.35±0.05 | 0.20±0.10 | 0.25±0.10 |
| TC03(0603) | 1.60±0.10 | 0.80±0.10 | 0.45±0.10 | 0.30±0.20 | 0.30±0.20 |
| TC05(0805) | 2.00±0.15 | 1.25+0.15/-0.10 | 0.55±0.10 | 0.30±0.20 | 0.40±0.20 |
| TC06(1206) | 3.10±0.15 | 1.55+0.15/-0.10 | 0.55±0.10 | 0.40±0.20 | 0.45±0.20 |
| TC07(1210) | 3.10±0.10 | 2.60±0.20 | 0.55±0.10 | 0.40±0.20 | 0.45±0.20 |
| TC10(2010) | 5.00±0.10 | 2.50±0.20 | 0.55±0.10 | 0.50±0.25 | 0.50±0.20 |
| TC12(2512) | 6.35±0.10 | 3.20±0.20 | 0.55±0.10 | 0.50±0.25 | 0.50±0.20 |

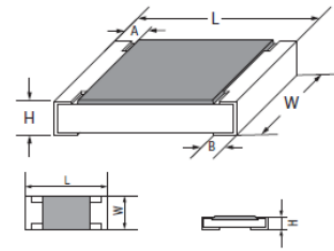

6. Resistance Range

| Type | Power rating | Operating Temperature | Max. Working Voltage | Max. Overload Voltage | Dielectric withstanding Voltage | Resistance Range | | | TCR (PPM/°C) |
|------|--------------|-----------------------|----------------------|-----------------------|---------------------------------|------------------|-----------------|-----------|--------------|
| | | | | | | ±0.01% ±0.05% | ±0.1% ±0.25% | ±0.5% | |
| TC02 | 1/16W | -55°C~155°C | 25V | 50V | 100V | / | 100Ω~2KΩ | 100Ω~2KΩ | ±5 |
| | | | | | | / | 50Ω~12KΩ | 50Ω~12KΩ | ±10 |
| | | | | | | / | 10Ω~332KΩ | 10Ω~332KΩ | ±25 |
| | | | | | | / | 10Ω~332KΩ | 10Ω~332KΩ | ±50 |
| TC03 | 1/10W | -55°C~155°C | 75V | 150V | 300V | / | 100Ω~4KΩ | 100Ω~4KΩ | ±5 |
| | | | | | | / | 10Ω~50KΩ | 10Ω~50KΩ | ±10 |
| | | | | | | 4.7Ω~332K | 4.7Ω~1MΩ | 1Ω~1MΩ | ±25 |
| | | | | | | 4.7Ω~332K | 4.7Ω~1MΩ | 1Ω~1MΩ | ±50 |
| TC05 | 1/8W | -55°C~155°C | 150V | 300V | 500V | / | 100Ω~15KΩ | 100Ω~15KΩ | ±5 |
| | | | | | | / | 10Ω~100KΩ | 10Ω~100KΩ | ±10 |
| | | | | | | 4.7Ω~511K | 4.7Ω~2MΩ | 1Ω~2MΩ | ±25 |
| | | | | | | 4.7Ω~511K | 4.7Ω~2MΩ | 1Ω~2MΩ | ±50 |
| TC06 | 1/4W | -55°C~155°C | 200V | 400V | 500V | / | 100Ω~15KΩ | 100Ω~15KΩ | ±5 |
| | | | | | | / | 10Ω~200KΩ | 10Ω~200KΩ | ±10 |
| | | | | | | 4.7Ω~1M | 4.7Ω~3MΩ | 1Ω~3MΩ | ±25 |
| | | | | | | 4.7Ω~1M | 4.7Ω~3MΩ | 1Ω~3MΩ | ±50 |
| TC07 | 1/3W | -55°C~155°C | 200V | 400V | 500V | / | 100Ω~15KΩ | 100Ω~15KΩ | ±5 |
| | | | | | | / | 10Ω~200KΩ | 10Ω~200KΩ | ±10 |
| | | | | | | 4.7Ω~1M | 4.7Ω~3MΩ | 1Ω~3MΩ | ±25 |
| | | | | | | 4.7Ω~1M | 4.7Ω~3MΩ | 1Ω~3MΩ | ±50 |
| TC10 | 1/2W | -55°C~155°C | 200V | 400V | 500V | / | 100Ω~25KΩ | 100Ω~25KΩ | ±5 |
| | | | | | | / | 50Ω~200KΩ | 50Ω~200KΩ | ±10 |
| | | | | | | 4.7Ω~1M | 4.7Ω~3MΩ | 1Ω~3MΩ | ±25 |
| | | | | | | 4.7Ω~1M | 4.7Ω~3MΩ | 1Ω~3MΩ | ±50 |
| TC12 | 3/4W | -55°C~155°C | 200V | 400V | 500V | / | 100Ω~25KΩ | 100Ω~25KΩ | ±5 |
| | | | | | | / | 50Ω~200KΩ | 50Ω~200KΩ | ±10 |
| | | | | | | 10Ω~1M | 4.7Ω~3MΩ | 1Ω~3MΩ | ±25 |
| | | | | | | 10Ω~1M | 4.7Ω~3MΩ | 1Ω~3MΩ | ±50 |

7. Soldering pad size recommended

| Type | Dimension(mm) | | | |
|------|---------------|-----------|----------|----------|
| | A | B | C | D |
| TC02 | 0.50±0.05 | 0.45±0.05 | 0.5±0.05 | 1.4±0.05 |
| TC03 | 0.8±0.05 | 0.65±0.05 | 0.8±0.05 | 2.1±0.05 |
| TC05 | 1.0±0.1 | 1.0±0.1 | 1.3±0.1 | 3.0±0.1 |
| TC06 | 2.0±0.1 | 1.1±0.1 | 1.6±0.1 | 4.2±0.1 |
| TC07 | 2.0±0.1 | 1.1±0.1 | 2.6±0.1 | 4.2±0.1 |
| TC10 | 3.6±0.1 | 1.3±0.1 | 2.6±0.1 | 6.2±0.1 |
| TC12 | 4.9±0.1 | 1.6±0.1 | 3.3±0.1 | 8.1±0.1 |

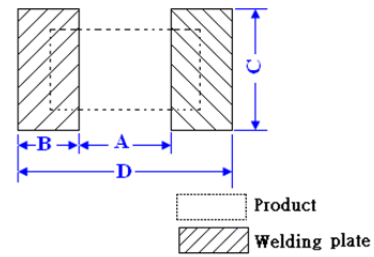

8. Derating Curve

Power rating will change based on continuous load at ambient temperature from -55 to 155°C.

It is constant between -55 to 70°C, and derate to zero when temperature rise from 70 to 155°C.

Voltage rating:

Resistors shall have a rated direct-current (DC) continuous working voltage or an approximate sine-wave root-mean-square (RMS) alternating-current (AC) continuous working voltage at commercial-line frequency and waveform corresponding to the power rating, as determined from the following formula:

$$RCWV = \sqrt{P} \times R$$

Remark: RCWV: Rating Continuous Working Voltage (Volt.) P: power rating (Watt) R: nominal resistance (Ω)

In no case shall the rated DC or RMS AC continuous working voltage be greater than the applicable maximum value.

The overload voltage is 2.5 times RCWV or Max. Overload voltage whichever is lower.

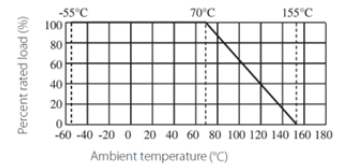

9. Structure

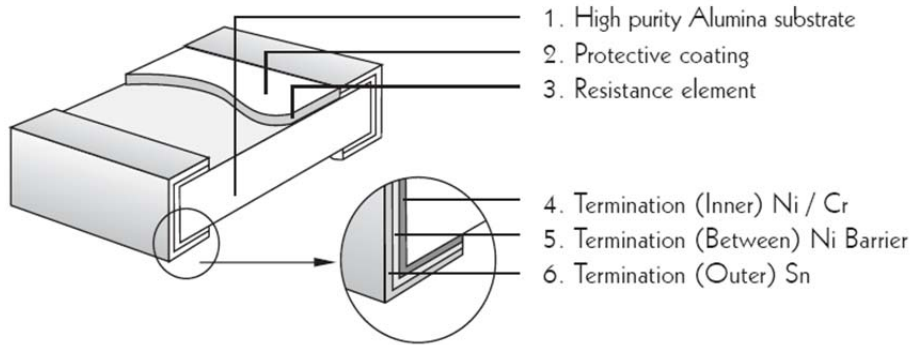

10. Performance Specification

| Characteristic | Limits | Test Method (GB/T5729&JIS-C-5201&IEC60115-1) |
|-------------------------|-------------------|--|
| Temperature Coefficient | Refer to item 6.0 | 4.8 Natural resistance changes per temp. Degree centigrade $\frac{R_2 - R_1}{R_1(t_2 - t_1)} \times 10^6 \text{ (PPM/°C)}$ R ₁ : Resistance Value at room temperature (t ₁) ; R ₂ : Resistance at test temperature (Upper limit temperature or Lower limit temperature) t ₁ : +25°C or specified room temperature t ₂ : Upper limit temperature or Lower limit temperature test temperature |
| Short-time overload | ΔR ≤ ±0.5% | 4.13 Permanent resistance change after the application of a potential of 2.5 times RCWV or Max. Overload Voltage whichever less for 5 seconds.. |
| Insulation resistance | ≥ 1000MΩ | 4.6 The measuring voltage shall be measured with a direct voltage of (100±15)V or a voltage equal to the dielectric withstanding voltage., and apply for 1min |

| | | |
|-----------------------------|---------------------------|--|
| Load life | $\Delta R \leq \pm 0.5\%$ | 4.25 Permanent resistance change after 1,000 hours operating at RCWV with duty cycle 1.5 hours "ON", 0.5 hour "OFF" at 70°C $\pm 2^\circ\text{C}$ ambient. |
| Humidity | $\Delta R \leq 0.3\%$ | 4.24 Temporary resistance change after 240 hours exposure in a humidity test chamber controlled at 40 $\pm 2^\circ\text{C}$ and 90-95% relative humidity, |
| Terminal bending | $\Delta R \leq \pm 0.2\%$ | 4.33 Twist of test board: Y/X = 3/90 mm for 60Seconds |
| Solderability | 95% coverage min. | 4.17 The area covered with a new, smooth, clean, shiny and continuous surface free from concentrated pinholes. Temperature of solder: 245 $\pm 3^\circ\text{C}$; Dwell time in solder: 2~3 seconds. |
| Soldering heat | $\Delta R \leq \pm 0.2\%$ | 4.18 Dip the resistor into a solder bath having a temperature of 260 $\pm 5^\circ\text{C}$ and hold it for 10 ± 1 seconds. |
| Load life in humidity | $\Delta R \leq \pm 0.5\%$ | 7.9 Resistance change after 1,000 hours (1.5 hours "ON", 0.5 hour "OFF") at RCWV in a humidity chamber controlled at 40 $\pm 2^\circ\text{C}$ and 90 to 95% relative humidity. |
| Low Temperature Storage | $\Delta R \leq \pm 0.5\%$ | IEC 60068-2-1(Aa) Lower limit temperature , for 2H. |
| High Temperature Exposure | $\Delta R \leq \pm 0.5\%$ | MIL-STD-202 108A Upper limit temperature , for 1000H. |
| Leaching | No visible damage | J-STD-002 Test D Samples completely immersed for 30 sec in solder bath at 260 $\pm 5^\circ\text{C}$. |
| Rapid change of temperature | $\Delta R \leq \pm 0.5\%$ | 4.19 30 min at lower limit temperature and 30 min at upper limit temperature , 100 cycles. |

11. Soldering Condition

(This is for recommendation, please customer perform adjustment according to actual application)

11.1 Recommend Reflow Soldering Profile : (solder : Sn96.5 / Ag3 / Cu0.5)

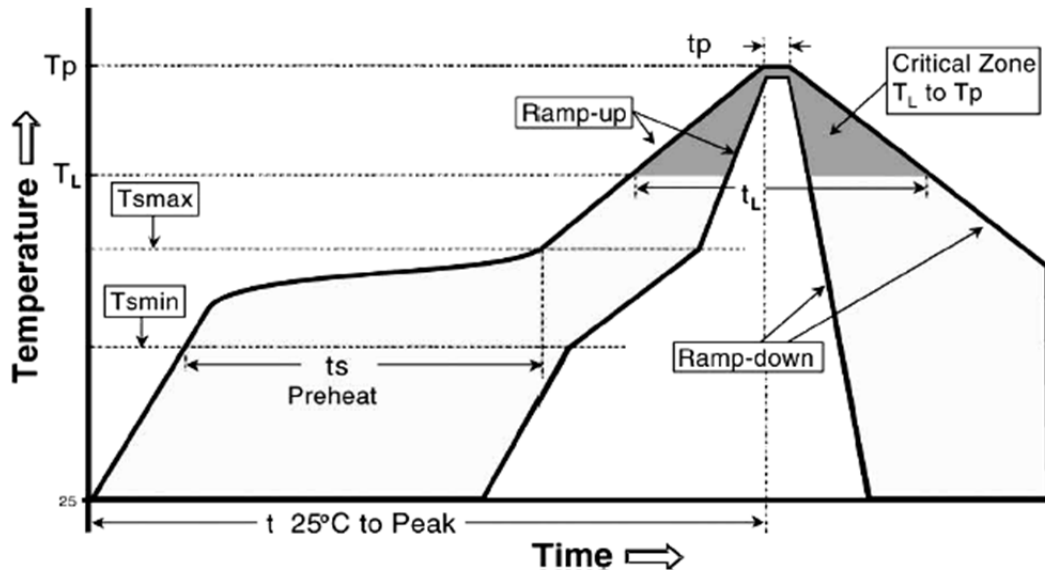

| Profile Feature | Lead (Pb)-Free solder |
|---|----------------------------------|
| Preheat: Temperature Min (T_{smin}) Temperature Max (T_{smax}) Time (T_{smin} to T_{smax}) (t_s) | 150°C 200°C 60 -120seconds |
| Average ramp-up rate: (T_{smax} to T_p) | 3°C / second max. |
| Time maintained above : Temperature (T_l) Time (t_l) | 217°C 60-150 seconds |
| Peak Temperature (T_p) | 260°C |
| Time within $+0$ -5 °C of actual peak Temperature (t_p) ² | 10 seconds |
| Ramp-down Rate | 6°C/second max. |
| Time 25°C to Peak Temperature | 8minutes max. |

Allowed Re-flow times : 2 times

Remark : To avoid discoloration phenomena of chip on terminal electrodes, please use N₂ Re-flow furnace .

11.2 Recommend Wave Soldering Profile : (Apply to 0603 and above size)

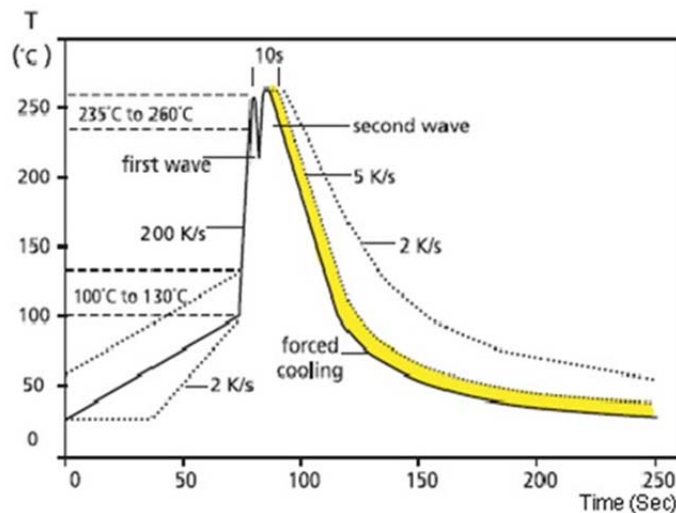

12. Packing

12.1 Dimension of Paper Taping :(Unit: mm)

| Type | A ±0.10 | B ±0.10 | C ±0.05 | $\Phi D_{-0}^{+0.1}$ | E ±0.1 | F ±0.05 | G ±0.1 | W ±0.2 | T ±0.05 |
|------|------------|------------|------------|----------------------|-----------|------------|-----------|-----------|------------|
| TC02 | 0.65 | 1.20 | 2.00 | 1.50 | 1.75 | 3.50 | 4.00 | 8.00 | 0.42 |

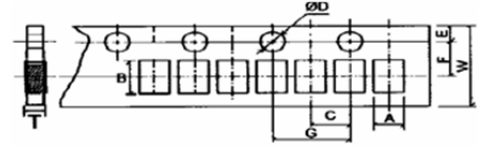

| Type | A ±0.2 | B ±0.2 | C ±0.05 | $\Phi D_{-0}^{+0.1}$ | E ±0.1 | F ±0.05 | G ±0.1 | W ±0.2 | T ±0.1 |
|------|-----------|-----------|------------|----------------------|-----------|------------|-----------|-----------|-----------|
| TC03 | 1.10 | 1.90 | 2.00 | 1.50 | 1.75 | 3.50 | 4.00 | 8.00 | 0.67 |
| TC05 | 1.65 | 2.40 | 2.00 | 1.50 | 1.75 | 3.50 | 4.00 | 8.00 | 0.81 |
| TC06 | 2.00 | 3.60 | 2.00 | 1.50 | 1.75 | 3.50 | 4.00 | 8.00 | 0.81 |
| TC07 | 2.80 | 3.50 | 2.00 | 1.50 | 1.75 | 3.50 | 4.00 | 8.00 | 0.75 |

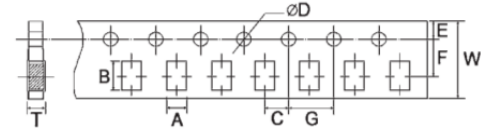

12.2 Dimension of plastic taping:(Unit: mm)

| Type | A ±0.2 | B ±0.2 | C ±0.05 | $\Phi D_{-0}^{+0.1}$ | $\Phi D1_{-0}^{+0.25}$ | E ±0.1 | F ±0.05 | G ±0.1 | W ±0.2 | T ±0.1 |
|------|-----------|-----------|------------|----------------------|------------------------|-----------|------------|-----------|-----------|-----------|
| TC10 | 2.90 | 5.60 | 2.00 | 1.50 | 1.50 | 1.75 | 5.50 | 4.00 | 12.00 | 1.00 |
| TC12 | 3.50 | 6.70 | 2.00 | 1.50 | 1.50 | 1.75 | 5.50 | 4.00 | 12.00 | 1.00 |

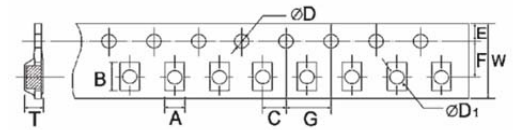

12.3 Dimension of Reel :(Unit: mm)

| Type | Taping | Qty/Reel | A ±0.5 | B ±0.5 | C ±0.5 | D ±1 | M ±2 | W ±1 |
|------|----------|-----------|-----------|-----------|-----------|---------|---------|---------|
| TC02 | Paper | 10,000pcs | 2.0 | 13.0 | 21.0 | 60.0 | 178.0 | 10.0 |
| TC03 | Paper | 5,000pcs | 2.0 | 13.0 | 21.0 | 60.0 | 178.0 | 10.0 |
| TC05 | Paper | 5,000pcs | 2.0 | 13.0 | 21.0 | 60.0 | 178.0 | 10.0 |
| TC06 | Paper | 5,000pcs | 2.0 | 13.0 | 21.0 | 60.0 | 178.0 | 10.0 |
| TC07 | Paper | 5,000pcs | 2.0 | 13.0 | 21.0 | 60.0 | 178.0 | 10.0 |
| TC10 | Embossed | 4,000pcs | 2.0 | 13.0 | 21.0 | 60.0 | 178.0 | 13.8 |
| TC12 | Embossed | 4,000pcs | 2.0 | 13.0 | 21.0 | 60.0 | 178.0 | 13.8 |

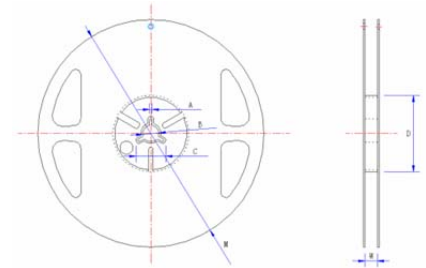

13. Note

13.1. UNI-ROYAL recommend products store in warehouse with temperature between 15 to 35°C under humidity between 25 to 75%RH.

Even under storage conditions recommended above, solder ability of products will be degraded stored over 1 year old.

13.2. Cartons must be placed in correct direction which indicated on carton, otherwise the reel or wire will be deformed.

13.3. Storage conditions as below are inappropriate:

- Stored in high electrostatic environment
- Stored in direct sunshine, rain, snow or condensation.
- Exposed to sea wind or corrosive gases, such as Cl₂, H₂S, NH₃, SO₂, NO₂, etc.

13.4 After the surface of TC series high resistance resistors is coated with flux, the resistance value may be affected (exceeding the resistance value range). After the customer's evaluation, if necessary, corresponding cleaning measures can be taken to restore the resistance. In addition, if the surface of the resistor needs to be coated with other substances, the client needs to evaluate the impact on the product to avoid any impact during use.

14. Record

| Version | Description | Page | Date | Amended by | Checked by |
|---------|--|------|---------------|-------------|------------|
| 1 | First version | 1~7 | Mar.20, 2018 | Haiyan Chen | Nana Chen |
| 2 | 1. Modify the power 2. Modify the resistance range | 3 | Mar.14, 2019 | Haiyan Chen | Yuhua Xu |
| 3 | Modify the dimension of A face value | 3 | Apr.23, 2019 | Haiyan Chen | Yuhua Xu |
| 4 | Modify the High Temperature Exposure conditions | 5 | July.29, 2019 | Haiyan Chen | Yuhua Xu |
| 5 | Add Tolerance | 2~ 3 | Apr.15,2020 | Haiyan Chen | Yuhua Xu |
| 6 | Modify the reflow curve and add the wave soldering curve | 6 | Apr.29, 2020 | Haiyan Chen | Yuhua Xu |
| 7 | Add the TC03 marking | 3 | Jan.14, 2021 | Haiyan Chen | Yuhua Xu |
| 8 | Modify the test limits for Load life 、 Low Temperature Storage 、 High Temperature Exposure and Rapid change of temperature | 6 | Jan.20,2021 | Song Nie | Yuhua Xu |
| 9 | Add the 13.4 | 8 | Jul.12,2021 | Haiyan Chen | John Zhao |

© Uniroyal Electronics Global Co., Ltd. All rights reserved. Specification herein will be changed at any time without prior notice.

X-ON Electronics

Largest Supplier of Electrical and Electronic Components

Click to view similar products for [Thick Film Resistors - SMD category](#):

Click to view products by [Uniroyal manufacturer](#):

Other Similar products are found below :

[CR-05FL7--150R](#) [CR-05FL7--698K](#) [CR-12FP4--324R](#) [CR-12JP4--680R](#) [M55342K06B10D0RS6](#) [M55342K06B14E0RS6](#)
[M55342K06B1E78RS3](#) [M55342K06B24E9RS6](#) [M55342K06B6E19RWL](#) [M55342K06B6E81RS3](#) [M55342M05B200DRWB](#)
[M55342M06B4K70MS3](#) [MC0603-511-JTW](#) [742C083750JTR](#) [MCR01MZPF1202](#) [MCR01MZPF1601](#) [MCR01MZPF1800](#)
[MCR01MZPF6201](#) [MCR01MZPF9102](#) [MCR01MZPJ113](#) [MCR01MZPJ121](#) [MCR01MZPJ125](#) [MCR01MZPJ751](#) [MCR03EZHZ103](#)
[MCR03EZPF2004](#) [MCR03EZPJ270](#) [MCR03EZPJ821](#) [MCR10EZPF1102](#) [MCR10EZPF2700](#) [MCR18EZPJ330](#) [RC1005F1152CS](#)
[RC1005F1182CS](#) [RC1005F1372CS](#) [RC1005F183CS](#) [RC1005F1911CS](#) [RC1005F1912CS](#) [RC1005F203CS](#) [RC1005F2052CS](#)
[RC1005F241CS](#) [RC1005F2431CS](#) [RC1005F3011CS](#) [RC1005F303CS](#) [RC1005F4321CS](#) [RC1005F4642CS](#) [RC1005F471CS](#)
[RC1005F4751CS](#) [RC1005F5621CS](#) [RC1005F6041CS](#) [RC1005J106CS](#) [RC1005J121CS](#)