



厚聲集團

Uni-Royal

以产品和服务成为电子制造业卓越的全球供货商。
做客户、企业成员、合作伙伴的尊敬企业。



2017 ~ 2018

厚聲電阻



Our Mission :

By providing reliable products and services for customers, business members and partners to create greatest value.

我们的使命：

通过提供可信赖的产品和服务，为顾客、企业成员和合作伙伴创造价值。

Our vision :

Become an outstanding global supplier of products and services to the electronics manufacturing industry, as a respected enterprises to customer, corporate members and partners.

我们的愿景：

以产品和服务成为电子制造业卓越的全球供货商。做客户、企业成员、合作伙伴的尊敬企业。



昆山厚声电子工业总部 (Kunshan HQ)

Uni-Royal Group is the world's leading chip resistor and dip resistor industry leader, founded in 1978 in Hsinchu, Taiwan. With more than 38 years of development and experience, the global electronics industry has a deep insight and innovative leadership capabilities. Uni-Royal has a complete R&D team in Taiwan, Kunshan, Xiamen, Shenzhen and Southeast Asia (Thailand), manufacturing plants and sales teams all over the world in the global marketing service network. Group's four famous brands: ROYALOHM, UNIOHM, FOSS, AEON, has become the world's industry customers most preferred, and reliable passive components of the important suppliers and preferred partners.

Uni-Royal has qualified in the ISO9001, ISO14001, TL9000 and TS16949 and other international quality system certification, products and services are widely used in the global electronics industries markets, chips, computers, civil and military and many other high-tech fields. In the past 38 years, the global economy continues to develop, scientific modernization, especially the rapid development of the electronics industry applications. Uni-Royal has always been to leading-edge technology, with the excellent products and industry-leading solutions. Providing the world's many well-known industry customers, for the electronic device-related products and services in full range of needs.

厚声集团是全球晶片电阻与插件电阻行业的领导者，1978年始创于台湾新竹。凭借逾三十八年的发展历程与经验，对全球电子行业拥有着深刻的行业洞察与创新领导的能力。厚声在台湾、昆山、厦门、深圳与东南亚（泰国）拥有完善的电阻研发团队、制造工厂及遍布全球的销售团队和营销服务网络。集团旗下四大著名品牌：ROYALOHM、UNIOHM、FOSS、AEON，已成为全球行业客户的首选，且备受信赖的被动元器件的重要供货商及首选合作伙伴。

厚声先后获得 ISO9001、ISO14001、TL9000 与 TS16949 等多项国际体系认证，产品广泛应用于全球电子——微电子、计算机、民用与军工等众多高科技领域。在过去的三十八年中，随着全球经济的不断发展、现代化的科技更替、特别是电子领域日新月异的应用革新，厚声始终以前沿的技术、出色的产品和领先的解决方案，向全球众多行业知名企业提供全方位的产品和服务。



Uni-Royal Group Growth

- 1978 (Hsinchu, Taiwan) Taiwan Uniroyal Electronics Industry Co., Ltd
- 1988 (Bangkok, Thailand) Royal Electronic Factory (Thailand) Co., Ltd.
- 1992 (Kunshan, China) Kunshan Uniroyal Electronics Industry Co., Ltd
- 2003 (Kunshan Optical Park) Kunshan Foss electronic materials
- 2004 to 2005 (Shenzhen, China) point of sale: Shenzhen Royal Electronics, Shenzhen Nanying Electronics
- 2005 (Kunshan High-tech Zone) Kunshan Uniroyal Electronics Industry Co., Ltd
- 2009 (Xiamen Xiang'an) Aeon technology (Xiamen)
- 2014 (Kunshan, China) Kunshan Uniroyal Optoelectronics technology
- 2016 (Kunshan, China) Sales HQ: Uniroyal International Trade (Kunshan), Xiamen Branch, Shenzhen Branch

厚声集团成长

- 1978年(台湾新竹)台湾厚声电子工业
- 1988年(泰国曼谷)泰国厚声电子工业
- 1992年(中国昆山)昆山厚声电子工业
- 2003年(昆山光电园)福仕电子材料
- 2004年~2005年(中国深圳)销售点: 深圳市泰伸科技、深圳市南瀛电子
- 2005年(昆山高新区)昆山厚声电子科技
- 2009年(厦门翔安)翔声科技(厦门)
- 2014年(中国昆山)昆山厚声光电科技
- 2016年(中国昆山)销售总公司: 厚声国际贸易(昆山)、厦门分公司、深圳分公司

泰国一厂 (Thailand 1988)

厦门厂 (Xiamen 2009)



昆山福仕厂 (Kunshan 2003)

泰国二厂 (Thailand 2015)



Resistor

Resistors are used in all electronic circuits to limit current. Uni-royal production of the resistance products include thin-film, thick-film, metal oxide film, carbon film and winding technology of a single (discrete) resistors, cement-type high-power resistors and various special areas of custom resistors.

电阻器

电阻器被用于所有的电子电路中来限制电流。厚声生产的电阻产品包括薄膜、厚膜、金属氧化物膜、碳膜和绕线技术的单个（分立）电阻器、水泥型大功率电阻器与各类特殊领域客制化电阻器。

Ceramic Materials

The world 's major manufacturers of high-quality materials suppliers, product including the resistance of the end products and semi-finished products; ceramic parts, cement resistance products shell; white porcelain rods, all kinds of traditional dip resistance matrix; component rods, other materials, film rods, tin-plated cap; all kinds of traditional dip resistor semi-finished products.

陶瓷材料

全球各大电阻厂商的优质材料供货商，产品包括电阻产品前段工艺和半成品；陶瓷件、水泥电阻产品外壳；白瓷棒、各类传统插件电阻基体；组分棒、各类传统插件电阻半成品；其他材料、着膜棒、镀锡铁帽、压帽白棒等。



To provide high-quality high-precision ceramic substrate to meet the consumer industry trends and high-end application requirements, used in high-end lighting industry, indoor and outdoor display and special lighting and other industries.

提供优质高精度陶瓷散热基板，满足消费行业发展趋势和高端应用需求，应用于高端照明行业、室内外显示屏及特殊照明等行业。



High-Precision Thin Film Chip Resistors-TC

The product uses precision thin film sputtering technology, By sputtering of high purity alloy target , the film structure is very compact & lon arraying regular, With the excellent temperature stability and noise coefficient, high reliability, products can be widely used for medical equipment, precision measurement equipment, communication and precision industrial control equipment.

高精度薄膜晶片电阻器

产品采用精密薄膜溅射技术，电阻层采用高纯度合金靶材溅射而成，膜层结构致密，离子间排列有规则，具有良好的温度稳定性及噪音系数、可靠性高，产品可广泛应用于医疗器材、精密测量仪器、通讯及精密工业控制设备中。

Anti-Sulfurized Thick Film Chip Resistors – NS

The resistor uses precision thick film printing technology; through the material and manufacture special process, the product has excellent corrosion resistance and anti-sulfurized performance, the product can be widely used in automotive electronics, petrochemical instrument, mining machinery, farm equipment and electronic equipment containing high sulfide gas zone.

抗硫化厚膜晶片电阻器

电阻采用精密厚膜印刷技术，通过特殊的材料及制做工艺，使产品具有极好的耐腐蚀性能及抗硫化性能，产品可广范应用于汽车电子，石化仪表，矿山机械，农场设备及含高硫化气体区域的电子设备。



A series of resistive networks and arrays in which multiple resistors are packaged together are also fabricated. Non-linear resistors for voltage rise due to temperature and voltage variations, as well as variable resistors, including potentiometers, Position sensors and electromagnetic encoders.

厚声生产将多个电阻封装在一起的电阻网络及排列电阻，另外还生产用于抑制由于温度和电压变化导致电压增高的非线性电阻器，以及可变电阻器，包括电位器、调整器、位置传感器和电磁编码器。

High-Voltage Thick Film Chip Resistors-HV

The resistor uses precision thick film printing technology, By the special product design and manufacturing process, have superior to voltage performance, Superior Max. working voltage is more than 2 times normal thick film chip, Could save SMT cost & size, and can effectively reduce the size of the final equipment .

高压厚膜晶片电阻器

电阻采用精密厚膜印刷技术，通过特有的产品设计及制做工艺，使产品具有极好的耐高电压性能，耐高电压特性是常规厚膜产品的2倍多，可减小电路板的安装空间及节约产品成本，同时可有效降低设备的最终尺寸。



Metal Strip Current Sensing Chip Resistors - MS

The products uses photolithography technology allowing patterns to be transfer on the substrate. The resistor layer uses metal alloy which provides excellent temperature stability and temperature coefficient of 30PPM/°C or even lower. This enables the product to be widely used for precision current dividing circuit and power management applications.

金属带电流检测片式电阻器

产品采用黄光影像转移技术，在陶瓷基板上形成电阻路，具有极好的温度稳定性，温度系数30PPM/°C，甚至可以做到更低，产品可广范用于电流检测电路及电源管理电路中。

| Product Name 名称 | Product specifications 产品规格 | Page |
|---|--|------|
| Thick Film Surface Mount Chip Resistors 厚膜表面贴装晶片电阻 | | |
| Ordinary Thick Film Resistors 普通厚膜晶片电阻器 | 01005, 0201, 0402, 0603, 0805, 1206, 1210, 1812, 2010, 2512 | 10 |
| High Resistance Thick Film Resistors 高阻厚膜晶片电阻器 | 0603, 0805, 1206, 1210 | 13 |
| High-Power Thick Film Chip Resistors-HP 高功率厚膜晶片电阻器 | HP02, HP03, HP05, HP06, HP07, HP10, HP11, HP12, SP12 | 14 |
| High-Voltage Thick Film Chip Resistors-HV 高压厚膜晶片电阻器 | HV03, HV05, HV06, HV07, HV10, HV12 | 16 |
| Anti-Surge Thick Film Chip Resistors-AS 抗浪涌厚膜晶片电阻器 | AS03, AS05, AS06, AS07, AS10, AS12 | 18 |
| High-Precision Anti-Surge Thick Film Chip Resistors-PS 高精度抗浪涌厚膜晶片电阻器 | PS02, PS03, PS05, PS06, PS07, PS10, PS12 | 20 |
| Low T.C.R Thick Film Chip Resistors - LT 低温度系数厚膜晶片电阻器 | LT02, LT03, LT05, LT06 | 22 |
| Wide Terminal Thick Film Chip Resistor-WR 宽电极厚膜晶片电阻器 | WR08, WR12, WR18, WR20, WR25 | 24 |
| Trimable Thick Film Chip Resistors-TR 可调厚膜晶片电阻器 | TR03, TR05, TR06 | 26 |
| Anti-Electro Static Discharge Thick Film Chip Resistors-ES 抗静电膜晶片电阻器 | ES01, ES02, ES03, ES05, ES06, ES07 | 28 |
| Non-magnetic Thick Film Chip Resistors - NM 无磁厚膜晶片电阻器 | NM02, NM03, NM05, NM06, NM12 | 30 |
| Thick Film Surface Mount Lead Free Chip Resistors 厚膜表面贴装无铅晶片电阻 | | |
| Complete Pb-Free Thick Film Chip Resistor- PF 完全无铅厚膜晶片电阻器 | PF0A, PF01, PF02, PF03, PF05, PF06, PF07, PF11, PF10, PF12 | 32 |
| Thin Film Type Surface Mount Chip Resistors 薄膜类表面贴装晶片电阻 | | |
| High-Precision Thin Film Chip Resistors-TC 高精度薄膜晶片电阻器 | TC02, TC03, TC05, TC06, TC07, TC10, TC12 | 34 |
| Current Sensing Chip Resistors 电流检测晶片电阻器 | | |
| Current Sensing Chip Resistors-CS 晶片电流检测电阻器 | CS02, CS03, CS05, CS06, CS07, CS10, CS11, CS12 | 36 |
| Metal Strip Current Sensing Chip Resistors - MS 金属带电流检测片式电阻器 | MS05, MS06, MS07, MS10, MS11, MS12, MS17, MS20, MS27 | 38 |
| Ultra Low Chip Resistors-LR 超低晶片电阻器 | LR06, LR10, LR12 | 40 |
| Chip Resistors Shunt -RS 贴片分流电阻器 | RS06, RS12, RS21, RS31 | 42 |
| AEC-Q200 Relevant Provision Resistor AEC-Q200 相关条款电阻器 | | |
| Anti-Sulfurized Thick Film Chip Resistors (Automotive Grade) - NS 抗硫化厚膜晶片电阻器 (汽车级) - NS | NS01, NS02, NS03, NS05, NS06, NS07, NS10, NS12 | 44 |
| AEC-Q200 Version Chip Resistors - HQ 汽车用晶片电阻器 | HQ02, HQ03, HQ05, HQ06, HQ07, HQ10, HQ12 | 46 |
| High Quality Anti-Sulfurized Thick Film Chip Resistors - NQ 高品质抗硫化厚膜电阻器 -NQ | NQ01, NQ02, NQ03, NQ05, NQ06, NQ07, NQ10, NQ12 | 48 |
| Anti-Sulfurized Thick Film Chip Resistor Array-Convex Terminal 抗硫化厚膜晶片排列电阻器 | 2S02, 4S02, 4S03 | 50 |
| Array-Convex Terminal & Network Resistors 排列 & 网络电阻 | | |
| Chip Resistor Array 晶片排列电阻器 | 2F01, 4F01, 2C02, 4C02, 4C03, 2D02, 2D03, 4D02, 4D03, 4DP3, 16P8 | 52 |
| Thick Film Chip Resistors Network 厚膜晶片网络电阻器 | 8R06, 8S06, 10P8, 10S8, 10T8, 10E9 | 54 |
| Packing of Surface Mount Resistors 表面贴装式电阻器包装 | Packing of Surface Mount Resistors | 55 |
| Through Hole Category-Film Resistors 插件类 - 膜层电阻 | | |
| Carbon Film Fixed Resistors 碳膜电阻器 | CFR, CPR | 57 |
| Precision Metal Film Fixed Resistors 精密金属膜电阻器 | MF | 59 |
| Power Metal Fixed Resistors 功率型金属膜固定电阻器 | PMR | 61 |
| Metal Oxide Film Fixed Resistors 金属氧化膜固定电阻器 | MOR | 63 |
| Terminal Type Metal Oxide Film Resistors 端片型金属氧化膜电阻器 | TMOR, TMOV, TMOL | 65 |
| Metal Glaze Film Fixed Resistors 金属玻璃釉膜固定电阻器 | MGR | 66 |
| Fusible Resistors 保险丝电阻器 | FRN | 68 |
| Through Hole Category-Wire-wound Resistors 插件类 - 绕线电阻 | | |
| Wire-Wound Fixed Resistors 绕线型固定电阻器 | KNP, KNH, KNS | 70 |
| Wire-Wound Non-Inductive Fixed Resistors 绕线型无感电阻器 | KNPN | 72 |
| Wire-Wound Anti-Surge Fixed Resistors 绕线耐脉冲电阻器 | KNPA | 74 |
| Wire-Wound Fusible Resistors 绕线保险丝型电阻器 | KNPU | 76 |
| Wire-Wound Power Resistors 高功率绕线型电阻器 | WPR | 78 |
| Thermal Fusing Wire-wound Fixed Resistors 绕线型温度保险丝电阻器 | TFR | 80 |
| Through Hole Category-Special type & Forming process Resistors 插件类 - 特殊型别 & 成型加工电阻 | | |
| Jumper Wires & Zero-Ohm Resistors 跳线及零欧姆电阻器 | ZW, ZOC, ZOT | 81 |
| Copper Plated Steel Lead Wire Type & Cutting Type 铜包钢导线型及切割半成型型 | CP, CO | 82 |
| Vertical Taping 立式编带 | Panasert, Avisert (AVI-1, AVI-2, AVI-3) | 83 |
| M & F Forming Type (M 型 & F 型 < 成型 >) | F, F1, F2, F3, M, MB, MC, MK, T | 86 |

| Product Name 名称 | Product specifications 产品规格 | Page |
|--|--|------|
| Heat-Shrinkable Tube Wrapped Forming Type 套热缩管加工成型 | TZ1, TZ2, TZ3, TM, TF | 87 |
| Carbon Film Leadless Fixed Resistors 碳膜无引线固定电阻器 | MC12、MC24、MC27、MC39 | 89 |
| Metal Film Leadless Fixed Resistors 金属膜无引线固定电阻器 | M12、M24、M27、M39 | 90 |
| Current Sense Resistors 电流检测电阻 | CSRA、CSRB、CSRC、CSRD、CSRE、CSSA、CSSB、CSSC | 93 |
| Standard Packing of Coated Type Resistors 涂装型电阻器包装标准 | Tape/Box, Tape/Reel, Bulk/Box | 95 |
| Thick Film Printing Through Hole Category-Network Resistors 厚膜印刷插件类 - 网络电阻 | | |
| Resistor Network - SIP Series 网络电阻器 - SIP 系列 | RNL、RPL、RNM、RPH | 104 |
| Special Network -SIP Series 特殊网络电阻器 - SIP 系列 | SN0001, SN0002, SN0003, SN0004, RCH, RCN, CNM, CNH | 108 |
| High Voltage Flat Resistors 高压扁平式电阻器 | HFR | 109 |
| Through Hole Category-Traditional Cement Resistors 插件类 - 水泥电阻 | | |
| Axial Leaded Type Cement Fixed Resistors-PRW Series 轴向导线型水泥固定电阻器 -PRW 系列 | PRW、PRWC、PRWC-1、PRWA | 110 |
| Radial Type Cement Fixed Resistors-PRM&PRS Series 立式水泥固定电阻器 -PRM&PRS 系列 | PRM、PRMA、PRMB、PRM、PRMT、 | 112 |
| Power Flat Alloy Resistors-PFA Series 功率型合金箔扁平电阻器 -PFA 系列 | PFAS、PFAP、PFAT | 114 |
| Radial Terminal Type Cement Fixed Resistors-PRT&PRU Series 立式端片型水泥固定电阻器 -PRT&PRU 系列 | PRU0、PRUA、PRUB、PRT0、PRTA、PRTB | 116 |
| Cement Power Type Resistors 水泥功率型电阻 | | |
| Radial Terminal Type Cement Fixed Resistors 立式端片型水泥固定电阻器 | PRVA、PRVB、PRZA、PRZA-1、PRZA-2、PRZC、PRZC-1、PRZD | 118 |
| Terminal Type-With metal mounting bracket 立式端片型带金属安装支架 | PRS、PRTC、PRTD、PRTM | 119 |
| Lead Type Cement Fixed Resistors 导线型水泥固定电阻器 | PHF-1、PHF-2、PHF-3、PRWI | 120 |
| Power Dissipation Mount Fixed Resistors- 铝外壳电阻器 | PDM、PDM-1、PDMS | 121 |
| High Power Wire-wound Aluminum Case Resistors 高功率绕线铝壳电阻器 | HBWR、HEWR | 122 |
| Power Alloy Wire-wound Resistors- 功率合金绕线电阻器 | QH、QL、QR、QRZG | 124 |
| Custom Resistors-Automotive 定制型电阻 - 汽车类 | | |
| Custom Resistors-Automotive-1 定制型电阻器 - 汽车 -1 | BCR、ASSY | 126 |
| Custom Resistors-Automotive-2 定制型电阻器 - 汽车 -2 | HFWR | 127 |
| Custom Resistors-Power Supply, Industrial Control 定制型电阻 - 电源、工控类 | | |
| Custom -Power Supply, Industrial Control-1 定制型电阻器 - 电源、工控 -1 | PHF、FTR、TFRC | 128 |
| Custom -Power Supply, Industrial Control-2 定制型电阻器 - 电源、工控 -2 | QHO、KNHW、KNHB | 129 |
| Custom -Power Supply, Industrial Control-3 定制型电阻器 - 电源、工控 -3 | HPWR、HAWF | 130 |
| Custom -Power Supply, Industrial Control-4 定制型电阻器 - 电源、工控 -4 | HAWR | 131 |
| Test Methods and Explanation 测试方法和注释 | | |
| Test Methods 检测方法 | | 135 |
| Standard Nominal Resistance Values 标准阻值 | | 136 |
| Explanation of Part No. System 料号系统注释 | | 139 |
| Standard Color Code System 标准色码系统 | | 141 |
| 电阻材料 Resistor material | | |
| Ceramic Rod 瓷棒 | OPD、OSD | 144 |
| Capped Ceramic Rod 组帽瓷棒 | OSC | 146 |
| Carbon Film Capped Ceramic Rod 碳膜组帽棒 | CRC、CRD | 148 |
| Metal Film Capped Ceramic Rod 金属膜组帽棒 | MFC、MFD | 150 |
| Metal Oxide Film Capped Ceramic Rod 金属氧化膜组帽棒 | MOC、MOD | 152 |
| Metal Glaze Capped Ceramic Rod 玻璃釉膜组帽棒 | MGC、MGD | 154 |
| Chemical Nickel - Plating Film Capped Ceramic Rod 化学沉积膜组帽棒 | CNC、CND | 156 |
| Zero ohm Copper Plated Rod 瓷棒镀铜膜 | ZOC | 158 |
| Zero ohm-Tinned Iron Rod 0Ω 镀锡铁棒 | TOEO | 158 |
| Tin-Plated Steel Cap 铁帽 | TOC | 160 |
| Ceramic Case 瓷壳 | CKO、CGO | 161 |
| LED Ceramic Substrate LED 陶瓷基板 | | |
| Thin-Film Ceramic Substrate - DPC 薄膜陶瓷基板 | 114.3*114.3mm*0.25/0.28/0.38/0.5/1.0mm | 165 |
| Thick-Film Ceramic Substrate- DPC 厚膜陶瓷基板 | 114.3x114.3x0.5mm | 168 |

Feature (特性)

- Small size & light weight 短小轻薄
- Reduction of assembly costs and matching with placement machine.
可降低装置成本及配合机器组装
- Suitable for both wave & re-flow soldering. 适合波峰焊与回流焊
- Applications: Navigator (GPS), Mobile Phone, Telecom, PDA, Setbox, Meter.
应用于GPS, 移动电话, PDA, 机顶盒, 仪表



Figures (形状)



Derating Curve & Specification

降功率曲线及性能

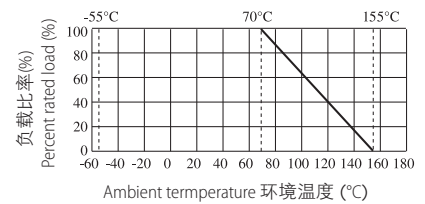

| Type 类型 | 01005 | 0201 | 0402 | 0603 | 0805 | 1206 | 1210 | 1812 | 2010 | 2512 |
|---|------------|------------|------------|------------|------------|------------|------------|------------|------------|------------|
| Size 尺寸 | 0402 | 0603 | 1005 | 1608 | 2012 | 3216 | 3225 | 4532 | 5025 | 6432 |
| Max. Working Voltage 最大工作电压 | 15V | 25V | 50V | 75V | 150V | 200V | 200V | 200V | 200V | 200V |
| Max. Overload Voltage 最大过负荷电压 | 30V | 50V | 100V | 150V | 300V | 400V | 500V | 500V | 500V | 500V |
| Dielectric withstanding Voltage 绝缘耐压 | - | - | 100V | 300V | 500V | 500V | 500V | 500V | 500V | 500V |
| Operating Temperature 工作温度范围 | -55~+155°C | -55~+155°C | -55~+155°C | -55~+155°C | -55~+155°C | -55~+155°C | -55~+155°C | -55~+155°C | -55~+155°C | -55~+155°C |

| Type 类型 | 01005 | 0201 | 0402 | 0603 | 0805 | 1206 | 1210 | 1812 | 2010 | 2512 | |
|---|-------|-----------|-----------|-----------|-----------|--|--|-----------|-----------|-----------|-----------|
| Dimension 尺寸 | L(mm) | 0.40±0.02 | 0.60±0.03 | 1.00±0.10 | 1.60±0.10 | 2.0±0.15 | 3.10±0.15 | 3.10±0.10 | 4.50±0.20 | 5.00±0.10 | 6.35±0.10 |
| | W(mm) | 0.20±0.02 | 0.30±0.03 | 0.50±0.05 | 0.80±0.10 | 1.25 ^{+0.15} _{-0.10} | 1.55 ^{+0.15} _{-0.10} | 2.60±0.20 | 3.20±0.20 | 2.50±0.20 | 3.20±0.20 |
| | H(mm) | 0.13±0.02 | 0.23±0.03 | 0.35±0.05 | 0.45±0.10 | 0.55±0.10 | 0.55±0.10 | 0.55±0.10 | 0.55±0.20 | 0.55±0.10 | 0.55±0.10 |
| | A(mm) | 0.10±0.05 | 0.10±0.05 | 0.20±0.10 | 0.30±0.20 | 0.40±0.20 | 0.45±0.20 | 0.50±0.25 | 0.50±0.20 | 0.60±0.25 | 0.60±0.25 |
| | B(mm) | 0.10±0.03 | 0.15±0.05 | 0.25±0.10 | 0.30±0.20 | 0.40±0.20 | 0.45±0.20 | 0.50±0.20 | 0.50±0.20 | 0.50±0.20 | 0.50±0.20 |
| Resistance Value of Jumper 零欧姆电阻阻值 | <50mΩ | | | | | | | | | | |
| Rated Current of Jumper 零欧姆电阻额定电流 | 0.5A | 0.5A | 1A | 1A | 2A | 2A | 2A | 2A | 2A | 2A | |
| Max. Overload Current of Jumper 零欧姆电阻最大过负荷电流 | 1A | 1A | 2A | 2A | 5A | 10A | 10A | 10A | 10A | 10A | |

| Type 类型 | 01005 | 0201 | 0402 | 0603 | 0805 | 1206 | 1210 | 1812 | 2010 | 2512 | |
|---|------------|----------|------------|--------------|-----------------|--------------|---------------|------------|------|------|----|
| Power Rating at 70°C 功率 | 1/32W | 1/20W | 1/16W | 1/10W | 1/8W | 1/4W | 1/4W | 1/3W | 1/2W | 3/4W | 1W |
| Resistance Range of 0.5%(E-96) 0.5% 的阻值范围 (E-96) | 1Ω~10MΩ | | | | | | | | | | |
| Resistance Range of 1%,2%(E-96) 1%,2% 的阻值范围 (E-96) | 10Ω ~ 10MΩ | 1Ω~ 10MΩ | 0.1Ω~ 10MΩ | 0.1Ω≤R< 10MΩ | 0.02Ω ≤R< 0.1 Ω | 0.1Ω≤R< 10MΩ | 0.01Ω≤R< 0.1Ω | 0.01Ω~10MΩ | | | |
| Resistance Range of 5%(E-24) 5% 的阻值范围 (E-24) | 1Ω~10MΩ | | 0.1Ω~ 10MΩ | 0.1Ω≤R< 10MΩ | 0.02Ω ≤R< 0.1 Ω | 0.1Ω≤R< 10MΩ | 0.01Ω≤R< 0.1Ω | 0.01Ω~10MΩ | | | |

Marking on the Resistors Body (电阻本体字码标示)

- For 01005, 0201, 0402 size, no marking on the body due to the small size of the resistor.
01005, 0201, 0402因电阻本体太小，故本体无标示字码
- ±5% tolerance product: the marking is 3 digits, the first 2 digits are the significant of the resistance and the 3rd digit denotes number of zeros following.
±5%公差产品字码是三位数，前二位是阻值的有效数，第三位表示有几个0
- 0805, 1206, 1210, 2010, 2512 ≤±1%: the marking is 4 digits, the first 3 digits are the significant of the resistance and the 4th digit denotes number of zeros following.
0805, 1206, 1210, 2010, 2512 ≤±1%公差产品字码有四位数字，前三位是阻值的有效数，第四位表示有几个0
- Standard E-96 series values of 0603 ≤±1%: due to the small size of the resistor's body, 3 digits marking will be used to indicate the accurate resistance value by using the following Multiplier & Resistance Code.
0603 ≤±1%公差 E-96系列标准阻值，因电阻本体太小，采用三位阻值代码（数字）及下列指数代码（字母）配合来指明标准的阻值。



153 = 15000Ω = 15KΩ



Below 10Ω: 6R8 = 6.8Ω
10Ω 以下标示: 6R8 = 6.8Ω



2372 = 23700Ω = 23.7KΩ



Below 10Ω: 3R24 = 3.24Ω
10Ω 以下标示: 3R24 = 3.24Ω

Multiplier Code (for 0603 ≤±1% marking) [指数码 (0603≤±1% 标示)]

| Code 代码 | A | B | C | D | E | F | G | H | X | Y | Z |
|---------------|-----------------|-----------------|-----------------|-----------------|-----------------|-----------------|-----------------|-----------------|------------------|------------------|------------------|
| Multiplier 指数 | 10 ⁰ | 10 ¹ | 10 ² | 10 ³ | 10 ⁴ | 10 ⁵ | 10 ⁶ | 10 ⁷ | 10 ⁻¹ | 10 ⁻² | 10 ⁻³ |

Standard E-96 series Resistance Value code (for 0603 ≤±1% marking) [E-96系列标准阻值代码 (对0603≤±1%的字码)]

| Value 阻值 | Code 代码 | Value 阻值 | Code 代码 | Value 阻值 | Code 代码 | Value 阻值 | Code 代码 | Value 阻值 | Code 代码 | Value 阻值 | Code 代码 |
|----------|---------|----------|---------|----------|---------|----------|---------|----------|---------|----------|---------|
| 100 | 01 | 147 | 17 | 215 | 33 | 316 | 49 | 464 | 65 | 681 | 81 |
| 102 | 02 | 150 | 18 | 221 | 34 | 324 | 50 | 475 | 66 | 698 | 82 |
| 105 | 03 | 154 | 19 | 226 | 35 | 332 | 51 | 487 | 67 | 715 | 83 |
| 107 | 04 | 158 | 20 | 232 | 36 | 340 | 52 | 499 | 68 | 732 | 84 |
| 110 | 05 | 162 | 21 | 237 | 37 | 348 | 53 | 511 | 69 | 750 | 85 |
| 113 | 06 | 165 | 22 | 243 | 38 | 357 | 54 | 523 | 70 | 768 | 86 |
| 115 | 07 | 169 | 23 | 249 | 39 | 365 | 55 | 536 | 71 | 787 | 87 |
| 118 | 08 | 174 | 24 | 255 | 40 | 374 | 56 | 549 | 72 | 806 | 88 |
| 121 | 09 | 178 | 25 | 261 | 41 | 383 | 57 | 562 | 73 | 825 | 89 |
| 124 | 10 | 182 | 26 | 267 | 42 | 392 | 58 | 576 | 74 | 845 | 90 |
| 127 | 11 | 187 | 27 | 274 | 43 | 402 | 59 | 590 | 75 | 866 | 91 |
| 130 | 12 | 191 | 28 | 280 | 44 | 412 | 60 | 604 | 76 | 887 | 92 |
| 133 | 13 | 196 | 29 | 287 | 45 | 422 | 61 | 619 | 77 | 909 | 93 |
| 137 | 14 | 200 | 30 | 294 | 46 | 432 | 62 | 634 | 78 | 931 | 94 |
| 140 | 15 | 205 | 31 | 301 | 47 | 442 | 63 | 649 | 79 | 953 | 95 |
| 143 | 16 | 210 | 32 | 309 | 48 | 453 | 64 | 665 | 80 | 976 | 96 |

So the resistance value are marked as the following examples (阻值标示如下):



1.96KΩ = 196 × 10¹ Ω = 29B



12.4Ω = 124 × 10⁻¹ = 10X

- Standard E-24 and not belong to E-96 series values (≤±1%) of 0603 size: the marking is the same as 5% tolerance but marking as underline.
0603≤±1%公差，在标准 E-24 系列中，但不属 E-96 系列的阻值，标示和5%的公差相同，但是在字码下多加一条线



122 = 1200 = 1.2 KΩ



680 = 68Ω

Performance Specifications (性能)

| | | | |
|---------------------------------|--------|--|---|
| Temperature coefficient | 温度系数 | 01005: $1\Omega \leq R \leq 10\Omega$: $\pm 600\text{ppm}/^\circ\text{C}$ $10\Omega < R \leq 100\Omega$: $\pm 400\text{ppm}/^\circ\text{C}$ $> 100\Omega$: $\pm 250\text{ppm}/^\circ\text{C}$ | 0805: $0.02\Omega < R \leq 0.030\Omega$: $\pm 1000\text{ppm}/^\circ\text{C}$ $0.03\Omega < R < 1\Omega$: $\pm 800\text{ppm}/^\circ\text{C}$ $1\Omega \leq R \leq 10\Omega$: $\pm 400\text{ppm}/^\circ\text{C}$ $> 10\Omega$: $\pm 100\text{ppm}/^\circ\text{C}$ |
| | | 0201: $1\Omega \leq R \leq 10\Omega$: $-100 \sim +350\text{ppm}/^\circ\text{C}$ $> 10\Omega$: $\pm 200\text{ppm}/^\circ\text{C}$ | 1206, 1210, 1812, 2010, 2512: $0.01\Omega \leq R \leq 0.015\Omega$: $\pm 1500\text{ppm}/^\circ\text{C}$ $0.015\Omega < R \leq 0.03\Omega$: $\pm 1000\text{ppm}/^\circ\text{C}$ $0.03\Omega < R < 1\Omega$: $\pm 800\text{ppm}/^\circ\text{C}$ $1\Omega \leq R \leq 10\Omega$: $\pm 400\text{ppm}/^\circ\text{C}$ $> 10\Omega$: $\pm 100\text{ppm}/^\circ\text{C}$ |
| | | 0402: $0.1\Omega \leq R < 1\Omega$: $\pm 800\text{ppm}/^\circ\text{C}$ $1\Omega \leq R \leq 10\Omega$: $\pm 400\text{ppm}/^\circ\text{C}$ $> 10\Omega$: $\pm 100\text{ppm}/^\circ\text{C}$ | |
| | | 0603: $0.1\Omega \leq R < 1\Omega$: $\pm 800\text{ppm}/^\circ\text{C}$ $1\Omega \leq R \leq 10\Omega$: $\pm 400\text{ppm}/^\circ\text{C}$ $10\Omega < R \leq 100\Omega$: $\pm 200\text{ppm}/^\circ\text{C}$ $> 100\Omega$: $\pm 100\text{ppm}/^\circ\text{C}$ | |
| Short-time overload | 短时间过负荷 | $\pm 5\%$, $\pm 2\%$: $\pm(2.0\% + 0.1\Omega)$ Max(最大). $\pm 1\%$, $\pm 0.5\%$: $\pm(1.0\% + 0.1\Omega)$ Max(最大). | |
| Insulation resistance | 绝缘电阻 | $\geq 1,000\text{ M}\Omega$ | |
| Dielectric withstanding voltage | 绝缘耐压 | No evidence of flashover, mechanical damage, arcing or insulation breakdown 无击穿, 飞弧及可见机械性损伤 | |
| Terminal bending | 端子弯曲 | $\pm(1.0\% + 0.05\Omega)$ Max(最大). | |
| Soldering heat | 耐焊接热 | $\pm(1.0\% + 0.05\Omega)$ Max(最大). | |
| Solderability | 可焊性 | Min. 95% coverage (最少 95% 覆盖率) | |
| Temperature cycling | 温度循环 | $\pm 5\%$, $\pm 2\%$: $\pm(1.0\% + 0.05\Omega)$ Max(最大). $\pm 1\%$, $\pm 0.5\%$: $\pm(0.5\% + 0.05\Omega)$ Max(最大). | |
| Humidity (Steady State) | 恒定湿热 | $\pm 5\%$, $\pm 2\%$: $\pm(3.0\% + 0.1\Omega)$ Max(最大). $\pm 1\%$, $\pm 0.5\%$: $\pm(0.5\% + 0.1\Omega)$ Max(最大). | |
| Load life in humidity | 湿度寿命 | $\pm 5\%$, $\pm 2\%$: $\pm(3.0\% + 0.1\Omega)$ Max(最大). $\pm 1\%$, $\pm 0.5\%$: $\pm(1\% + 0.1\Omega)$ Max(最大). | |
| Load life | 负载寿命 | $\pm 5\%$, $\pm 2\%$: $\pm(3.0\% + 0.1\Omega)$ Max(最大). $\pm 1\%$, $\pm 0.5\%$: $\pm(1\% + 0.1\Omega)$ Max(最大). | |

• The values which are not of standard E-24 series (2% & 5%) and not of E-96 series (1%) could be offered on a case to case basis.
阻值如不在 E-24 系列 (2% & 5%) 及 E-96 系列 (1%) 可特别提供

Ordering Procedure (Example: 1206 1/4W 5% 1.2 Ω T/R-5000)

订购方式 (例如: 1206 1/4W 5% 1.2 Ω T/R-5000)

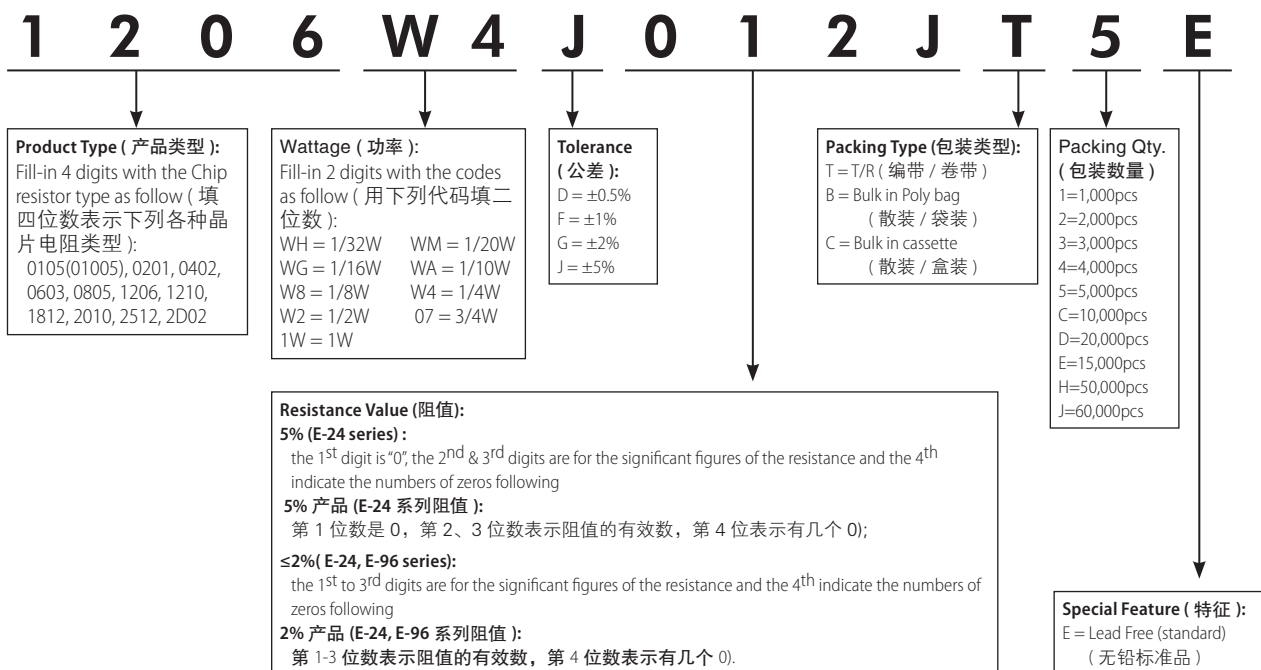

Feature (特性)

- High Resistance 高阻值
- Suitable for reflow & wave soldering 适合波峰焊与回流焊
- Application AV adapters, LCD back-light camera strobe etc. 适用于AV适配器, LCD背光电路, 照相机快门等。

Figures (型状)



Derating Curve & Specification (降功率曲线及性能)



| Type 类型 | Max Working Voltage 最大工作电压 | Max Overload Voltage 最大过负荷电压 | Dielectric Withstanding Voltage 绝缘耐压 | Operating Temperature Range 工作温度范围 |
|---------|----------------------------|------------------------------|--------------------------------------|------------------------------------|
| 0603 | 75V | 150V | 300V | -55~+155°C |
| 0805 | 150V | 300V | 500V | |
| 1206 | 200V | 400V | 500V | |
| 1210 | 200V | 500V | 500V | |

| Type 类型 | Size 尺寸 | Power (功率) (70°C) | L (mm) | W (mm) | H (mm) | A (mm) | B (mm) | Resistance Range (阻值范围) 5% (E24) |
|---------|---------|-------------------|-----------|--|-----------|-----------|-----------|----------------------------------|
| 0603 | 1608 | 1/10W | 1.60±0.10 | 0.80±0.10 | 0.45±0.10 | 0.30±0.20 | 0.30±0.20 | 10M~100M |
| 0805 | 2012 | 1/8W | 2.00±0.15 | 1.25 ^{+0.15} _{-0.10} | 0.55±0.10 | 0.40±0.20 | 0.40±0.20 | |
| 1206 | 3216 | 1/4W | 3.10±0.15 | 1.55 ^{+0.15} _{-0.10} | 0.55±0.10 | 0.45±0.20 | 0.45±0.20 | |
| 1210 | 3225 | 1/2W | 3.10±0.10 | 2.60±0.20 | 0.55±0.10 | 0.50±0.25 | 0.50±0.20 | |

Performance Specification (性能)

| | | |
|---------------------------------|--------|---|
| Temperature coefficient | 温度系数 | ±200ppm/°C |
| Short time overload | 短时间过负荷 | ±(2.0%+0.1Ω) Max (最大) |
| Terminal bending | 端子弯曲 | ±(1.0%+0.05Ω) |
| Solderability | 可焊性 | Min 95% coverage (最少 95% 覆盖率) |
| Dielectric withstanding voltage | 绝缘耐压 | No evidence of flashover, mechanical damage, arcing or insulation breakdown (无击穿, 飞弧及可见机械性损伤) |
| Soldering heat | 耐焊接热 | ±(1.0%+0.05Ω) Max (最大) |
| Temperature cycling | 温度循环 | ±(1.0%+0.05Ω) Max (最大) |
| Load Life in humidity | 湿度寿命 | ±(3.0%+0.1Ω) Max (最大) |
| Load life | 负载寿命 | ±(3.0%+0.1Ω) Max (最大) |
| Humidity (steady state) | 恒定湿热 | ±(3.0%+0.1Ω) Max (最大) |
| Insulation resistance | 绝缘电阻 | ≥1,000 MΩ |

Feature (特性)

- High power in standard size
标准尺寸，高功率
- Suitable for both wave & re-flow soldering
适合波峰焊与回流焊
- Application: AV adapters, LCD back-light, camera strobe etc. 适用于AV适配器, LCD背光电路, 照相机快门等

Figures (型状)



Derating Curve & Specification (降功率曲线及性能)



| Type 类型 | L(mm) | W(mm) | H(mm) | A(mm) | B(mm) |
|-------------|-----------|--|-----------|-----------|-----------|
| HP02 (0402) | 1.00±0.10 | 0.50±0.05 | 0.35±0.05 | 0.20±0.10 | 0.25±0.10 |
| HP03 (0603) | 1.60±0.10 | 0.80±0.10 | 0.45±0.10 | 0.30±0.20 | 0.30±0.20 |
| HP05 (0805) | 2.00±0.15 | 1.25 ^{+0.15} _{-0.10} | 0.55±0.10 | 0.40±0.20 | 0.40±0.20 |
| HP06 (1206) | 3.10±0.15 | 1.55 ^{+0.15} _{-0.10} | 0.55±0.10 | 0.45±0.20 | 0.45±0.20 |
| HP07 (1210) | 3.10±0.10 | 2.60±0.20 | 0.55±0.10 | 0.50±0.25 | 0.50±0.20 |
| HP10 (2010) | 5.00±0.10 | 2.50±0.20 | 0.55±0.10 | 0.60±0.25 | 0.50±0.20 |
| HP11 (1812) | 4.50±0.20 | 3.20±0.20 | 0.55±0.20 | 0.50±0.20 | 0.50±0.20 |
| HP12 (2512) | 6.35±0.10 | 3.20±0.20 | 0.55±0.10 | 0.60±0.25 | 0.50±0.20 |
| SP12 (2512) | 6.35±0.10 | 3.20±0.15 | 1.10±0.10 | 0.60±0.25 | 1.80±0.20 |

*Special offered 特别提供 : HP12 B:1.80±0.25mm

| Type 类型 | Size 尺寸 | Power Rating at 70°C 功率 | Resistance Range of 1% & 5% 1% & 5% 的阻值范围 | Max. Working Voltage 最大工作电压 | Max. Overload Voltage 最大过负荷电压 | Dielectric Withstanding Voltage 绝缘耐压 | Operating Temperature 工作温度范围 |
|---------|-------------|-------------------------|---|-----------------------------|-------------------------------|--------------------------------------|------------------------------|
| HP02 | 0402 (1005) | 1/10W | 1Ω~10M 0Ω | 50V | 100V Rmax=10mΩ, Imax=3A | 100V | -55°C~155°C |
| HP03 | 0603 (1608) | 1/5W | 0.1Ω~10M 0Ω | 75V | 150V Rmax=8mΩ, Imax=5A | 300V | -55°C~155°C |
| HP05 | 0805 (2012) | 1/3W | 10mΩ~10M 0Ω | 150V | 300V Rmax=5mΩ, Imax=6A | 500V | -55°C~155°C |
| HP06 | 1206 (3216) | 1/2W | 10mΩ~10M 0Ω | 200V | 400V Rmax=5mΩ, Imax=10A | 500V | -55°C~155°C |
| HP07 | 1210 (3225) | 3/4W | 0.1Ω~10M 0Ω | 200V | 500V Rmax=4mΩ, Imax=12A | 500V | -55°C~155°C |
| HP10 | 2010 (5025) | 1W | 10mΩ~10M 0Ω | 200V | 500V Rmax=5mΩ, Imax=12A | 500V | -55°C~155°C |
| HP11 | 1812 (4532) | 1.25W | 0.1Ω~10M 0Ω | 200V | 500V Rmax=5mΩ, Imax=12A | 500V | -55°C~155°C |
| HP12 | 2512 (6432) | 2W | 10mΩ~10M 0Ω | 250V | 500V Rmax=5mΩ, Imax=16A | 500V | -55°C~155°C |
| SP12 | 2512 (6432) | 3W | 1Ω~10M | 250V | 500V | 500V | -55°C~155°C |

Performance Specifications (性能)

| | | |
|--|---------------|--|
| Temperature coefficient | 温度系数 | <p>HP02: $1\Omega \leq R \leq 10\Omega$: ± 400 ppm/$^{\circ}\text{C}$ $10\Omega < R \leq 100\Omega$: ± 200 ppm/$^{\circ}\text{C}$ $100\Omega < R \leq 10\text{M}$: ± 100 ppm/$^{\circ}\text{C}$</p> <p>HP03: $0.1\Omega \leq R < 0.2\Omega$: ± 200 ppm/$^{\circ}\text{C}$ $0.2\Omega \leq R \leq 10\text{M}$: ± 100 ppm/$^{\circ}\text{C}$</p> <p>HP05: $10\text{m}\Omega \leq R \leq 15\text{m}\Omega$: ± 800 ppm/$^{\circ}\text{C}$ $15\text{m}\Omega < R \leq 25\text{m}\Omega$: ± 600 ppm/$^{\circ}\text{C}$ $25\text{m}\Omega < R \leq 50\text{m}\Omega$: ± 400 ppm/$^{\circ}\text{C}$ $50\text{m}\Omega < R < 0.1\Omega$: ± 200 ppm/$^{\circ}\text{C}$ $0.1\Omega \leq R \leq 10\text{M}$: ± 100 ppm/$^{\circ}\text{C}$</p> <p>HP06: $10\text{m}\Omega \leq R < 15\text{m}\Omega$: ± 700 ppm/$^{\circ}\text{C}$ $15\text{m}\Omega \leq R < 30\text{m}\Omega$: ± 400 ppm/$^{\circ}\text{C}$ $30\text{m}\Omega \leq R < 50\text{m}\Omega$: ± 300 ppm/$^{\circ}\text{C}$ $50\text{m}\Omega \leq R < 0.1\Omega$: ± 150 ppm/$^{\circ}\text{C}$ $0.1\Omega \leq R \leq 10\text{M}$: ± 100 ppm/$^{\circ}\text{C}$</p> <p>HP07, HP11, SP12: ± 100 ppm/$^{\circ}\text{C}$</p> <p>HP10: $10\text{m}\Omega \leq R < 15\text{m}\Omega$: $0 \sim +800$ ppm/$^{\circ}\text{C}$ $15\text{m}\Omega \leq R < 50\text{m}\Omega$: $0 \sim +600$ ppm/$^{\circ}\text{C}$ $50\text{m}\Omega \leq R < 10\text{M}$: ± 100 ppm/$^{\circ}\text{C}$</p> <p>HP12: $10\text{m}\Omega \leq R < 20\text{m}\Omega$: $0 \sim +800$ ppm/$^{\circ}\text{C}$ $20\text{m}\Omega \leq R \leq 50\text{m}\Omega$: $0 \sim +400$ ppm/$^{\circ}\text{C}$ $50\text{m}\Omega < R \leq 10\text{M}$: ± 75 ppm/$^{\circ}\text{C}$</p> |
| Short-time overload | 短时间过负荷 | <p>$\pm 5\%$: $\pm(2.0\% + 0.1\Omega)$ Max.(最大) $\pm 1\%$: $\pm(1.0\% + 0.1\Omega)$ Max.(最大)</p> |
| Dielectric withstanding voltage | 绝缘耐压 | No Evidence of flashover, mechanical damage, arcing or insulation breakdown 无击穿, 飞弧及可见机械性损伤 |
| Terminal bending | 端子弯曲 | $\pm(1.0\% + 0.05\Omega)$ Max.(最大) |
| Soldering heat | 耐焊接热 | $\pm(1.0\% + 0.05\Omega)$ Max.(最大) |
| Solderability | 可焊性 | Min. 95% Coverage (最少 95% 覆盖率) |
| Temperature cycling | 温度循环 | <p>$\pm 5\%$: $\pm(1.0\% + 0.05\Omega)$ Max.(最大) $\pm 1\%$: $\pm(0.5\% + 0.05\Omega)$ Max.(最大)</p> |
| Humidity (Steady state) | 恒定湿热 | <p>$\pm 5\%$: $\pm(3.0\% + 0.1\Omega)$ Max.(最大) $\pm 1\%$: $\pm(0.5\% + 0.1\Omega)$ Max.(最大)</p> |
| Load life in humidity | 湿度寿命 | <p>$\pm 5\%$: $\pm(3.0\% + 0.1\Omega)$ Max.(最大) $\pm 1\%$: $\pm(1.0\% + 0.1\Omega)$ Max.(最大)</p> |
| Load life | 负载寿命 | <p>$\pm 5\%$: $\pm(3.0\% + 0.1\Omega)$ Max.(最大) $\pm 1\%$: $\pm(1.0\% + 0.1\Omega)$ Max.(最大)</p> |

Ordering Procedure (Example: High Power HP06 1/2W 5% 120K Ω T/R-5000)

订购方式 (例如: 高功率 HP06 1/2W 5% 120K Ω T/R-5000)



Feature (特性)

- Superiority in Max. Working Voltage performance than general thick film Chip Resistors. 在最大工作电压上优于普通厚膜晶片电阻
- Suitable for both wave & re-flow soldering 适合波峰焊及回流焊
- Application: AV adapter, LCD Backlight, Flash Light of camera 适用于AV适配器、LCD背光电路、照相机的闪光灯等

Figures (型状)



Derating Curve & Specification (降功率曲线及性能)



| Type 类型 | Max. Working Voltage 最大工作电压 | Max. Overload Voltage 最大过负荷电压 | Dielectric Withstanding Voltage 绝缘耐压 | Operating Temperature 工作温度范围 |
|---------|-----------------------------|-------------------------------|--------------------------------------|------------------------------|
| HV03 | 200V | 400V | 300V | -55°C~155°C |
| HV05 | 400V | 800V | 500V | -55°C~155°C |
| HV06 | 500V | 1000V | 500V | -55°C~155°C |
| HV07 | 800V | 1500V | 500V | -55°C~155°C |
| HV10 | 2000V | 3000V | 500V | -55°C~155°C |
| HV12 | 3000V | 4000V | 500V | -55°C~155°C |

| Type 类型 | Size 尺寸 | Power Rating 功率 at 70°C | L(mm) | W(mm) | H(mm) | A(mm) | B(mm) | Resistance Range 阻值范围 1% & 5% |
|---------|-------------|-------------------------|-----------|--|-----------|-----------|------------|-------------------------------|
| HV03 | 0603 (1608) | 1/10W | 1.60±0.10 | 0.80±0.10 | 0.45±0.10 | 0.30±0.20 | 0.30± 0.20 | 36KΩ~10MΩ |
| HV05 | 0805 (2012) | 1/8W | 2.00±0.15 | 1.25 ^{+0.15} _{-0.10} | 0.55±0.10 | 0.40±0.20 | 0.40± 0.20 | 100KΩ~10MΩ |
| HV06 | 1206 (3216) | 1/4W | 3.10±0.15 | 1.55 ^{+0.15} _{-0.10} | 0.55±0.10 | 0.45±0.20 | 0.45±0.20 | 100KΩ~10MΩ |
| HV07 | 1210 (3225) | 1/2W | 3.10±0.10 | 2.60±0.20 | 0.55±0.10 | 0.50±0.25 | 0.50±0.20 | 50KΩ~10MΩ |
| HV10 | 2010 (5025) | 3/4W | 5.00±0.10 | 2.50±0.20 | 0.55±0.10 | 0.60±0.25 | 0.50±0.20 | 50KΩ~10MΩ |
| HV12 | 2512 (6432) | 1W | 6.35±0.10 | 3.20±0.20 | 0.55±0.10 | 0.60±0.25 | 0.50±0.20 | 39KΩ~10MΩ |

The non-standard value can be offered on a case to case basis. 特殊规格可特别提供

Performance Specification (性能)

| | | |
|---------------------------------|--------|--|
| Temperature coefficient | 温度系数 | ±100PPM/°C |
| Short-time overload | 短时间过负荷 | ±(2.0%+0.1Ω) Max.(最大) |
| Terminal bending | 端子弯曲 | ±(1.0%+0.05Ω) Max.(最大) |
| Solderability | 可焊性 | Min. 95% Coverage (最少 95% 覆盖率) |
| Temperature Cycling | 温度循环 | 5% : ±(1.0%+0.05Ω) Max.(最大) 1% : ±(0.5%+0.05Ω) Max.(最大) |
| Humidity (Steady State) | 恒定湿热 | ±(3.0%+0.1Ω) Max.(最大) |
| Load life in humidity | 湿度寿命 | ±(3.0%+0.1Ω) Max.(最大) |
| Load life | 负载寿命 | ±(3.0%+0.1Ω) Max.(最大) |
| Insulation resistance | 绝缘电阻 | ≥1,000MΩ |
| Dielectric withstanding voltage | 绝缘耐压 | No evidence of flashover, mechanical damage, arcing or insulation breakdown 无击穿, 飞弧及可见机械性损伤 |
| Soldering heat | 耐焊接热 | ±(1.0% + 0.05Ω) Max.(最大) |

Ordering Procedure (Example: High Voltage HV06 1/4W 5% 120KΩ T/R-5000)

订购方式 (例如: 高压 HV06 1/4W 5% 120KΩ T/R-5000)



Feature (特性)

- Superior Anti-Surge Voltage performance.
优越的抗浪涌电压特性
- Suitable for both wave & re-flow soldering
适合波峰焊与回流焊
- Application AV adapters, LCD back-light camera strobe etc.
适用于AV适配器、LCD背光电路、照相机的快门等

Figures (型状)



Derating Curve (降功率曲线)



Curve of Pulse Duration (脉冲曲线)



Pulse Voltage Limit (电压曲线)



Specification (规格)

| Type 类型 | Size 尺寸 | Max. Working Voltage 最大工作电压 | Max. Overload Voltage 最大过负荷电压 | Dielectric Withstanding Voltage 绝缘耐压 | Operating Temperature 工作温度范围 |
|------------|-------------|--------------------------------|----------------------------------|---|---------------------------------|
| AS03 | 0603 (1608) | 75V | 150V | 300V | -55~+155°C |
| AS05 | 0805 (2012) | 150V | 300V | 500V | |
| AS06 | 1206 (3216) | 200V | 400V | 500V | |
| AS07 | 1210 (3225) | 200V | 500V | 500V | |
| AS10 | 2010 (5025) | 400V | 800V | 500V | |
| AS12 | 2512 (6432) | 500V | 1000V | 500V | |

| Type 类型 | Power (功率) (70°C) | L (mm) | W (mm) | H (mm) | A (mm) | B (mm) | Resistance Range 阻值范围 | Tolerance 公差 |
|------------|----------------------|-----------|--|-----------|-----------|-----------|--------------------------|---------------------|
| AS03 | 1/4W | 1.60±0.10 | 0.80±0.10 | 0.45±0.10 | 0.30±0.20 | 0.30±0.20 | 1Ω~10M | ±5% ±10% ±20% |
| AS05 | 1/2W | 2.00±0.15 | 1.25 ^{+0.15} _{-0.10} | 0.55±0.10 | 0.40±0.20 | 0.40±0.20 | | |
| AS06 | 0.6W | 3.10±0.15 | 1.55 ^{+0.15} _{-0.10} | 0.55±0.10 | 0.45±0.20 | 0.45±0.20 | | |
| AS07 | 3/4W | 3.10±0.10 | 2.60±0.20 | 0.55±0.10 | 0.50±0.25 | 0.50±0.20 | | |
| AS10 | 1.5W | 5.00±0.10 | 2.50±0.20 | 0.55±0.10 | 0.60±0.25 | 0.50±0.20 | | |
| AS12 | 2W | 6.35±0.10 | 3.20±0.20 | 0.55±0.10 | 0.60±0.25 | 0.50±0.20 | | |

*Special offered 特别提供: AS12 B:1.80±0.25mm

Performance Specifications (性能)

| | | |
|---------------------------------|--------|--|
| Temperature coefficient | 温度系数 | 1Ω≤R≤10Ω: ±400ppm/°C 10Ω<R≤10M: ±100ppm/°C |
| Short-time overload | 短时间过负荷 | ±(1.0%+0.1Ω) Max (最大) |
| Terminal bending | 端子弯曲 | ±(1.0%+0.05Ω) Max (最大) |
| Solderability | 可焊性 | Min 95% coverage (最少 95% 覆盖率) |
| Dielectric withstanding voltage | 绝缘耐压 | No evidence of flashover, mechanical damage, arcing or insulation breakdown 无击穿, 飞弧及可见机械性损伤 |
| Soldering heat | 耐焊接热 | ±(1.0%+0.05Ω) Max (最大) |
| Temperature cycling | 温度循环 | ±(1.0%+0.05Ω) Max (最大) |
| Load Life in humidity | 湿度寿命 | ±(3.0%+0.1Ω) Max (最大) |
| Load life | 负载寿命 | ±(3.0%+0.1Ω) Max (最大) |
| Humidity (Steady State) | 恒定湿热 | ±(3.0%+0.1Ω) Max (最大) |
| Single pulse | 单脉冲 | ±(1.0%+0.1Ω) Max (最大) |

Ordering Procedure (Example: Anti-surge AS03 1/4W 5% 10KΩ T/R-5000)

订购方式 (例如: 抗浪涌 AS03 1/4W 5% 10KΩ T/R-5000)



Feature (特性)

- High-Precision, high-power, anti-pulse 高精度、高功率、抗脉冲
- Suitable for reflow & wave soldering 适合波峰焊与回流焊
- Application monitors, power supplies, DVD, camcorder, laptop computer 适用于显示器、电源、DVD 摄像机、手提电脑



Figures (型状)



Derating Curve (降功率曲线)

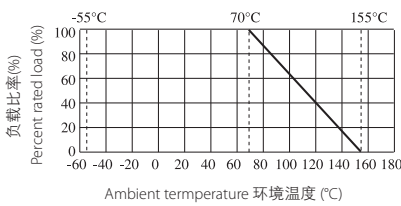

Curve of Pulse Duration (脉冲曲线)



Pulse Voltage Limit (电压曲线)



Specification (性能)

| Type 类型 | Size 尺寸 | Max working voltage 最大工作电压 | Max Overload Voltage 最大过负荷电压 | Dielectric Withstanding Voltage 绝缘耐压 | Operating Temperature 工作温度范围 |
|---------|-------------|----------------------------|------------------------------|--------------------------------------|------------------------------|
| PS02 | 0402 (1005) | 50V | 100V | 100V | -55~+155°C |
| PS03 | 0603 (1608) | 50V | 100V | 300V | |
| PS05 | 0805 (2012) | 150V | 300V | 500V | |
| PS06 | 1206 (3216) | 200V | 400V | 500V | |
| PS07 | 1210 (3225) | 200V | 500V | 500V | |
| PS10 | 2010 (5025) | 400V | 800V | 500V | |
| PS12 | 2512 (6432) | 500V | 1000V | 500V | |

| Type 类型 | Power 功率 (70°C) | L (mm) | W (mm) | H (mm) | A (mm) | B (mm) | Resistance Range 阻值范围 1%(E96), 5%(E24) |
|---------|-----------------|-----------|--|-----------|-----------|-----------|--|
| PS02 | 1/8W | 1.00±0.10 | 0.50±0.05 | 0.35±0.05 | 0.20±0.10 | 0.25±0.10 | 1Ω~10M |
| PS03 | 1/4W | 1.60±0.10 | 0.80±0.10 | 0.45±0.10 | 0.30±0.20 | 0.30±0.20 | |
| PS05 | 1/3W | 2.00±0.15 | 1.25 ^{+0.15} _{-0.10} | 0.55±0.10 | 0.40±0.20 | 0.40±0.20 | 0.1Ω~10M |
| PS06 | 1/2W | 3.10±0.15 | 1.55 ^{+0.15} _{-0.10} | 0.55±0.10 | 0.45±0.20 | 0.45±0.20 | |
| PS07 | 3/4W | 3.10±0.10 | 2.60±0.20 | 0.55±0.10 | 0.55±0.25 | 0.50±0.20 | |
| PS10 | 1.25W | 5.00±0.10 | 2.50±0.20 | 0.55±0.10 | 0.60±0.25 | 0.50±0.20 | 1Ω~10M |
| PS12 | 2W | 6.35±0.10 | 3.20±0.20 | 0.55±0.10 | 0.60±0.25 | 0.50±0.20 | |

*Special offered 特别提供: PS12 B:1.80±0.25mm

Performance Specification (性能)

| | | |
|--|---------------|--|
| Temperature coefficient | 温度系数 | PS02: 1Ω~10Ω: ±400PPM/°C 11Ω~100Ω: ±200PPM/°C >100Ω: ±100PPM/°C PS03, PS05, PS06, PS07, PS10, PS12: ±100ppm/°C |
| Short-time overload | 短时间过负荷 | ±1%:(1.0%+0.1Ω)Max. (最大) ±5%:(2.0%+0.1Ω)Max. (最大) |
| Terminal bending | 端子弯曲 | ±(1.0%+0.05Ω) Max. (最大) |
| Solderability | 可焊性 | Min. 95% Coverage (最少 95% 覆盖率) |
| Soldering heat | 耐焊接热 | ±(1.0% + 0.05Ω) Max.(最大) |
| Load life in humidity | 湿度寿命 | ±1%:(1.0%+0.1Ω)Max. (最大) ±5%:(3.0%+0.1Ω) Max. (最大) |
| Dielectric withstanding voltage | 绝缘耐压 | No evidence of flashover, mechanical damage, arcing or insulation breakdown 无击穿, 飞弧及可见机械性损伤 |
| Temperature Cycling | 温度循环 | ±1%:(0.5%+0.1Ω) Max. (最大) ±5%:(3.0%+0.1Ω) Max. (最大) |
| Load life | 负载寿命 | ±1%:(1.0%+0.1Ω) Max. (最大) ±5%:(3.0%+0.1Ω) Max. (最大) |
| Single pulse | 单脉冲 | ±(1.0%+0.1Ω)Max. (最大) |

Ordering Procedure (Example: PS05 1/3W 5% 120KΩ T/R-5000)

订购方式 (例如: PS05 1/3W 5% 120KΩ T/R-5000)

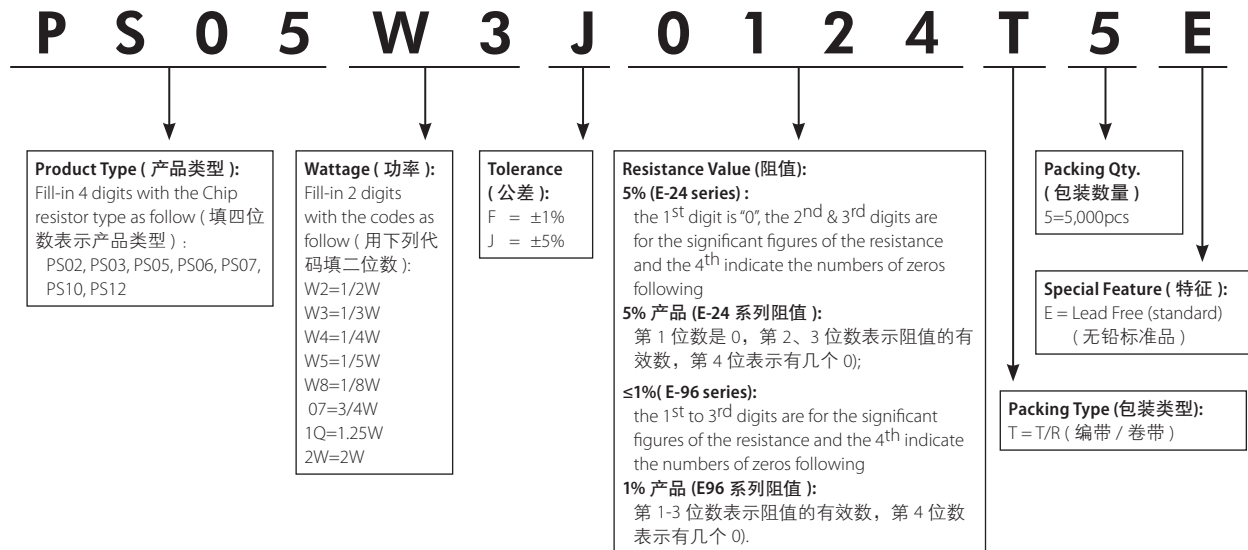

Feature (特性)

- Low T.C.R $\pm 50\text{PPM}/^\circ\text{C}$ 低T.C.R $\pm 50\text{PPM}/^\circ\text{C}$
- Suitable for reflow & wave soldering 适合波峰焊与回流焊
- Application Precision medical equipment, Auto industrial control system, Communication equipment, IPAD, Portable computer, LED lamps, Intelligent home appliances
适用于精密医疗器械、自动工业控制系统、通讯设备、IPAD、手提电脑、LED 灯具、智能家电产品等

Derating Curve (降功率曲线)



Figures (型状)



1. High purity Alumina substrate 高纯度氧化铝基板
2. Protective coating 保护层
3. Resistance element 阻抗元素
4. Termination (Inner) Ni / Cr 端面(内)镍/铬层
5. Termination (Between) Ni Barrier 端面(中)镍层
6. Termination (Outer) Sn 端面(外)锡层(无铅)

Specification (性能)

| Type 类型 | Size 尺寸 | Max working voltage 最大工作电压 | Max Overload Voltage 最大过负荷电压 | Dielectric Withstanding Voltage 绝缘耐压 | Operating Temperature 工作温度范围 |
|------------|-------------|-------------------------------|---------------------------------|---|---------------------------------|
| LT02 | 0402 (1005) | 50V | 100V | 100V | -55~+155°C |
| LT03 | 0603 (1608) | 75V | 150V | 300V | |
| LT05 | 0805 (2012) | 150V | 300V | 500V | |
| LT06 | 1206 (3216) | 200V | 400V | 500V | |

| Type 类型 | Power 功率 (70°C) | L (mm) | W (mm) | H (mm) | A (mm) | B (mm) | Resistance Range 阻值范围 0.25%, 0.5%, 1% |
|------------|--------------------|-----------|--|-----------|-----------|-----------|---|
| LT02 | 1/16W | 1.00±0.10 | 0.50±0.05 | 0.35±0.05 | 0.20±0.10 | 0.25±0.10 | 100Ω~1MΩ |
| LT03 | 1/10W | 1.60±0.10 | 0.80±0.10 | 0.45±0.10 | 0.30±0.20 | 0.30±0.20 | 10Ω~1MΩ |
| LT05 | 1/8W | 2.00±0.15 | 1.25 ^{+0.15} _{-0.10} | 0.55±0.10 | 0.40±0.20 | 0.40±0.20 | |
| LT06 | 1/4W | 3.10±0.15 | 1.55 ^{+0.15} _{-0.10} | 0.55±0.10 | 0.45±0.20 | 0.45±0.20 | |

Performance Specifications (性能)

| | | |
|-------------------------|--------|---|
| Temperature coefficient | 温度系数 | LT02: $\pm 50\text{ppm}/^\circ\text{C}$ LT03: $1\Omega \leq R \leq 10\Omega$: $\pm 200\text{ppm}/^\circ\text{C}$ $10\Omega < R \leq 1\text{M}\Omega$: $\pm 50\text{ppm}/^\circ\text{C}$ LT05: $1\Omega \leq R \leq 10\Omega$: $\pm 100\text{ppm}/^\circ\text{C}$ $10\Omega < R \leq 1\text{M}\Omega$: $\pm 50\text{ppm}/^\circ\text{C}$ LT06: $1\Omega \leq R \leq 10\Omega$: $\pm 100\text{ppm}/^\circ\text{C}$ $10\Omega < R \leq 1\text{M}\Omega$: $\pm 50\text{ppm}/^\circ\text{C}$ |
| Short-time overload | 短时间过负荷 | $\pm(1.0\%+0.1\Omega)\text{Max}$ (最大) |
| Terminal Bending | 端子弯曲 | $\pm(1.0\%+0.05\Omega)\text{Max}$ (最大) |
| Solderability | 可焊性 | Min 95% coverage (最少95%覆盖率) |
| Soldering heat | 耐焊接热 | $\pm(1.0\%+0.05\Omega)\text{Max}$ (最大) |
| Humidity (Steady State) | 恒定温湿 | $\pm(0.5\%+0.05\Omega)\text{Max}$ (最大) |
| Load life | 负载寿命 | $\pm(1.0\%+0.1\Omega)\text{Max}$ (最大) |

Ordering Procedure (Example: LT02 1/16W 1% 100KΩ T/R-10000)

订购方式 (例如: LT02 1/16W 1% 100KΩ T/R-10000)



Feature (特性)

- High power & Wide terminal 高功率，宽电极
- Suitable for both wave & re-flow soldering 适合波峰焊及回流焊
- Application: AV adapters, LCD back-light, camera strobe etc.
适用于AV适配器，LCD背光电路，照相机阀门等

Figures (型状)



1. Protective layer (保护层)
2. Resistive element (阻抗元素)
3. Termination (Inner) Ni / Cr [端面(内)镍/铬层]
4. Termination (Between) Ni [端面(中)镍层]
5. Termination (Outer) Sn [端面(外)锡层(无铅)]
6. High purity Alumina substrate (高纯度氧化铝基板)

Derating Curve & Specification (降功率曲线及性能)



| Type 类型 | L (mm) | W(mm) | H(mm) | A(mm) | B(mm) |
|------------|-----------|-----------|-----------|-----------|-----------|
| WR08(0508) | 1.20±0.10 | 2.0±0.10 | 0.55±0.10 | 0.20±0.10 | 0.30±0.20 |
| WR12(0612) | 1.60±0.15 | 3.20±0.15 | 0.55±0.10 | 0.30±0.20 | 0.45±0.20 |
| WR20(1020) | 2.50±0.15 | 5.00±0.15 | 0.55±0.10 | 0.40±0.20 | 0.60±0.20 |
| WR18(1218) | 3.10±0.10 | 4.60±0.15 | 0.55±0.10 | 0.45±0.20 | 0.40±0.20 |
| WR25(1225) | 3.10±0.15 | 6.25±0.15 | 0.55±0.10 | 0.45±0.20 | 0.65±0.20 |

| Type 类型 | Size 尺寸 | Power 功率 70°C | Resistance Range 阻值范围 | | Max. Working Voltage 最大工作电压 / 电流 | Max. Overload Voltage 最大过负荷电压 / 电流 | Dielectric Withstanding Voltage 绝缘耐压 | Operating Temperature 工作温度范围 | T.C.R 温度系数 PPM/°C |
|---------|---------|------------------|-----------------------|---------|----------------------------------|------------------------------------|--|------------------------------|--|
| | | | 1% | 5% | | | | | |
| WR08 | 1220 | 1/3W | 10Ω~1M | | 150V | 300V | 500V | -55°C ~ 155°C | 10Ω<R≤100Ω:±200 >100Ω:±100 |
| | | 2/3W | 10mΩ~1Ω | | / | / | | | 10mΩ≤R<30mΩ:0~+400 30mΩ≤R≤1Ω:0~+150 |
| | | / | <50mΩ | | 4A | 8A | | | / |
| WR12 | 1632 | 1/2W | 10Ω~1M | 1Ω<R≤1M | 200V | 400V | 1Ω<R≤10Ω:±400 10Ω<R≤100Ω:±200 >100Ω:±100 | | |
| | | 1W | 10mΩ≤R≤1Ω | | / | / | 10mΩ≤R<100mΩ:0~+200 100mΩ≤R≤1Ω:0~+150 | | |
| | | / | <50mΩ | | 5A | 10A | / | | |
| WR20 | 2532 | 1W | 10Ω~1M | 1Ω~1M | 200V | 400V | 1Ω<R≤10Ω:±400 10Ω<R≤100Ω:±200 >100Ω:±100 | | |
| | | / | 10mΩ~1Ω | | / | / | 10mΩ≤R<30mΩ:0~+200 30mΩ≤R≤1Ω:0~+100 | | |
| | | / | <50mΩ | | 6A | 12A | / | | |
| WR18 | 3245 | 1W | 10mΩ~1M | | 200V | 400V | 10mΩ≤R<30mΩ:0~+200 30mΩ≤R≤1Ω:0~+100 1Ω<R≤10Ω:±400 10Ω<R≤100Ω:±200 >100Ω:±100 | | |
| | | / | <50mΩ | | 6A | 10A | / | | |
| | | 2W | 1Ω<R≤1M | | 200V | 400V | 1Ω<R≤10Ω:±400 10Ω<R≤100Ω:±200 >100Ω:±100 | | |
| WR25 | 3264 | 3W | 10mΩ~1Ω | | / | / | 10mΩ≤R<30mΩ:0~+150 30mΩ≤R≤1Ω:0~+100 | | |
| | | / | <50mΩ | | 6A | 15A | / | | |
| | | 2W | 1Ω<R≤1M | | 200V | 400V | 1Ω<R≤10Ω:±400 10Ω<R≤100Ω:±200 >100Ω:±100 | | |

Performance Specification (性能)

| | | |
|---------------------------------|--------|---|
| Short-time overload | 短时间过负荷 | ±5%: $\pm(2.0\% \pm 0.1\Omega)$ Max.(最大) ±1%: $\pm(1.0\% \pm 0.1\Omega)$ Max.(最大) |
| Dielectric withstanding voltage | 绝缘耐压 | No evidence of flashover mechanical damage, arcing or insulation break down. 无击穿, 电弧及可见机械性损伤 |
| Terminal bending | 端子弯曲 | $\pm (1.0\% + \pm 0.05\Omega)$ Max.(最大) |
| Soldering heat | 耐焊接热 | $\pm (1.0\% + 0.05\Omega)$ Max.(最大) |
| Solderability | 可焊性 | Min.95% coverage (最少 95% 覆盖) |
| Temperature cycling | 温度循环 | ±5%: $\pm(1.0\% \pm 0.05\Omega)$ Max.(最大) ±1%: $\pm(0.5\% \pm 0.05\Omega)$ Max.(最大) |
| Load life in humidity | 湿度寿命 | ±5%: $\pm(3.0\% \pm 0.1\Omega)$ Max.(最大) ±1%: $\pm(1.0\% \pm 0.1\Omega)$ Max.(最大) |
| Load life | 负载寿命 | ±5%: $\pm(3.0\% \pm 0.1\Omega)$ Max.(最大) ±1%: $\pm(1.0\% \pm 0.1\Omega)$ Max.(最大) |

Ordering Procedure (Example:Wide Terminal WR18 1W 5% 120KΩ T/R-4000)

订购方式 (例如: 宽电极WR18 1W 5% 120KΩ T/R-4000)

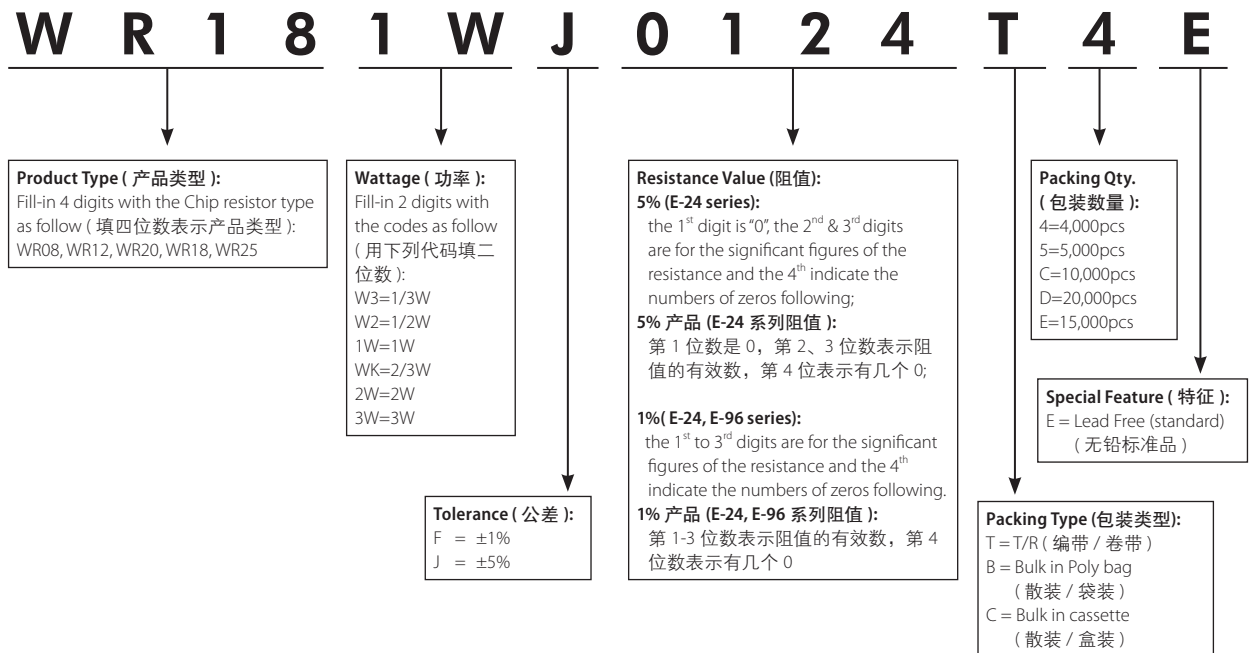

Feature (特性)

- Apply to stable circuit instead of regulating circuit to adjust the application of resistance (laser adjusting resistance machine in client end)
适用于稳定电路中，代替调节电路来调节阻值的应用(客户端激光调阻机)
- Superior heat & humidity withstanding performance 良好的耐高温耐湿性

Figures (型状)

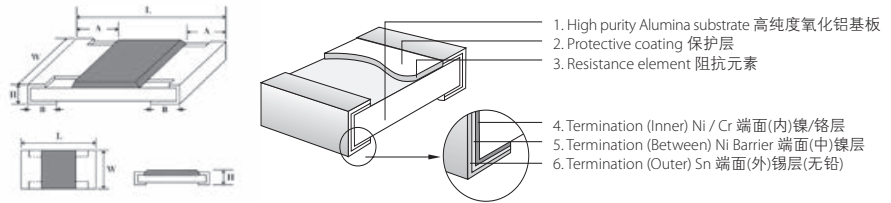

Derating Curve & Specification (降功率曲线及性能)

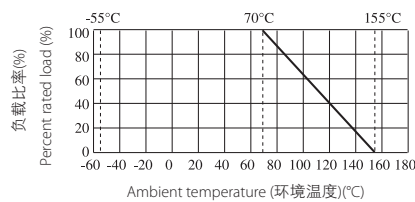

| Type 类型 | Max. Working Voltage 最大工作电压 | Max. Overload Voltage 最大过负荷电压 | Operating Temperature 工作温度范围 |
|---------|-----------------------------|-------------------------------|------------------------------|
| TR03 | 75V | 150V | -55°C~155°C |
| TR05 | 150V | 300V | -55°C~155°C |
| TR06 | 200V | 400V | -55°C~155°C |

| Type 类型 | Size 尺寸 | Power Rating 功率 70°C | L(mm) | W(mm) | H(mm) | A(mm) | B(mm) | Tolerance 公差 | Resistance Range 阻值范围 (E-12) |
|---------|-------------|----------------------|-----------|--|-----------|-----------|-----------|---|------------------------------|
| TR03 | 0603 (1608) | 1/10W | 1.60±0.10 | 0.80±0.10 | 0.45±0.10 | 0.30±0.20 | 0.30±0.20 | R: 0~30% Q: 0~20% T: 0~10% S: -10~0% N: -20~0% P: -30~0% J: ±5% K: ±10% M: ±20% | 1Ω~1M |
| TR05 | 0805 (2012) | 1/8W | 2.00±0.15 | 1.25 ^{+0.15} _{-0.10} | 0.55±0.10 | 0.40±0.20 | 0.40±0.20 | | |
| TR06 | 1206 (3216) | 1/4W | 3.10±0.15 | 1.55 ^{+0.15} _{-0.10} | 0.55±0.10 | 0.45±0.20 | 0.45±0.20 | | |

Performance Specification (性能)

| | |
|------------------------------|--|
| Temperature coefficient 温度系数 | TR03: 1Ω≤R≤10Ω: ±400ppm/°C >10Ω: ±200ppm/°C TR05, TR06: ±200PPM/°C |
| Short-time overload 短时间过负荷 | ±(2.0%+0.1Ω) Max.(最大) |
| Terminal bending 端子弯曲 | ±(1.0%+0.05Ω) Max.(最大) |
| Solderability 可焊性 | Min. 95% coverage (最少 95% 覆盖率) |
| Soldering heat 耐焊接热 | ±(1.0%+0.05Ω) Max.(最大) |
| Temperature cycling 温度循环 | ±(1.0%+0.05Ω) Max.(最大) |
| Load life in humidity 湿度寿命 | ±(3.0%+0.1Ω) Max.(最大) |
| Load life 负载寿命 | ±(3.0%+0.1Ω) Max.(最大) |

Ordering Procedure (Example: Trimmable TR06 1/4W ±20% 120KΩ T/R-5000)

订购方式 (例如: 可调 TR06 1/4W ±20% 120KΩ T/R-5000)

The values which are not of standard E-12 series could be offered on a case to case basis.
阻值如不在 E-12 系列的可特别提供。

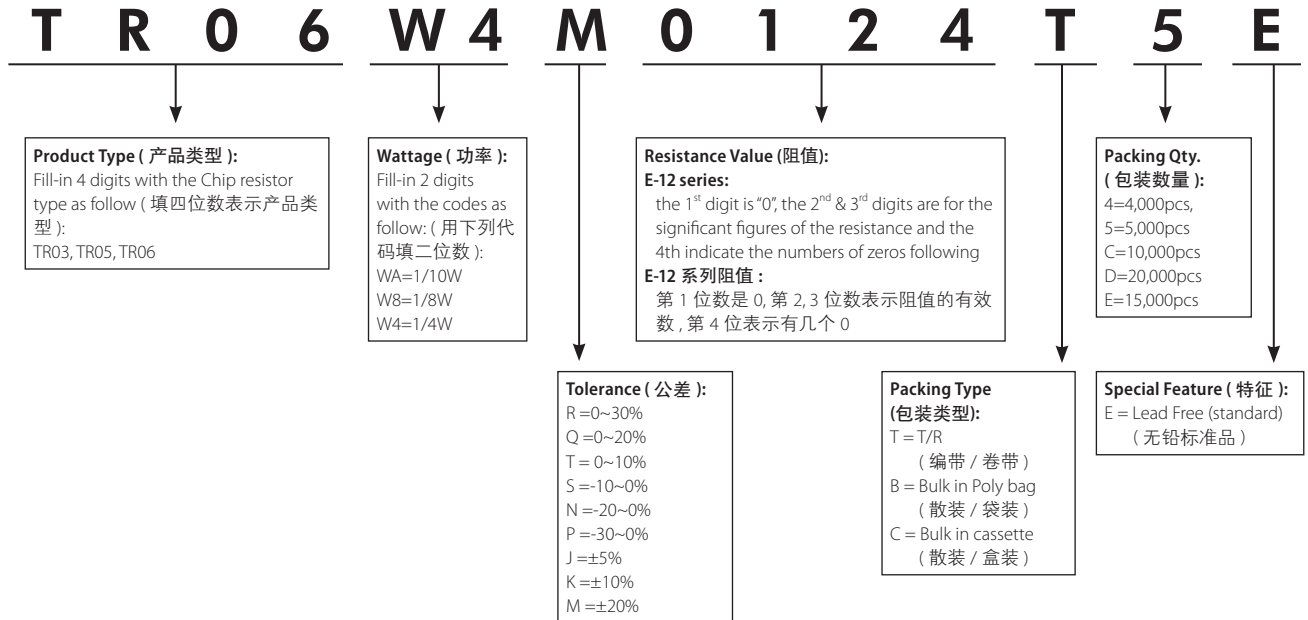

Feature (特性)

- Anti-Electro Static Discharge 抗静电
- High voltage 耐高压
- Suitable for reflow & wave soldering 适合波峰焊与回流焊
- Application Medical Devices, Industrial Controls, AV adapter, Flash lamp of camera, Automotive Industry, Outdoor Equipments
适用于医疗器械、工业控制、电源适配器、照相机的闪光灯、汽车工业及户外设备等

Derating Curve (降功率曲线)



Figures (型状)

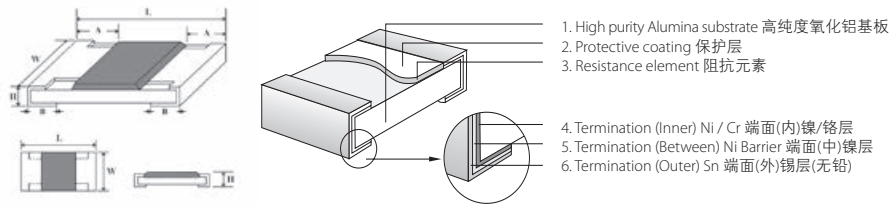

Specification (性能)

| Type 类型 | Size 尺寸 | Max working voltage 最大工作电压 | Max Overload Voltage 最大过负荷电压 | Dielectric Withstanding Voltage 绝缘耐压 | Operating Temperature 工作温度范围 |
|------------|-------------|-------------------------------|---------------------------------|---|---------------------------------|
| ES01 | 0201 (0603) | 25V | 50V | / | -55~+155°C |
| ES02 | 0402 (1005) | 50V | 100V | 100V | |
| ES03 | 0603 (1608) | 150V | 200V | 300V | |
| ES05 | 0805 (2012) | 200V | 400V | 500V | |
| ES06 | 1206 (3216) | 500V | 1000V | 500V | |
| ES07 | 1210 (3225) | 800V | 1500V | 500V | |

| Type 类型 | Power 功率 (70°C) | L (mm) | W (mm) | H (mm) | A (mm) | B (mm) | Resistance Range 阻值范围 1% & 5% |
|------------|--------------------|-----------|--|-----------|-----------|-----------|-------------------------------------|
| ES01 | 1/20W | 0.60±0.03 | 0.30±0.03 | 0.23±0.03 | 0.10±0.05 | 0.15±0.05 | 1Ω~10MΩ |
| ES02 | 1/16W | 1.00±0.10 | 0.50±0.05 | 0.35±0.05 | 0.20±0.10 | 0.25±0.10 | |
| ES03 | 1/4W | 1.60±0.10 | 0.80±0.10 | 0.45±0.10 | 0.30±0.20 | 0.30±0.20 | |
| ES05 | 2/5W | 2.00±0.15 | 1.25 ^{+0.15} _{-0.10} | 0.55±0.10 | 0.40±0.20 | 0.40±0.20 | |
| ES06 | 2/3W | 3.10±0.15 | 1.55 ^{+0.15} _{-0.10} | 0.55±0.10 | 0.45±0.20 | 0.45±0.20 | |
| ES07 | 1/2W | 3.10±0.10 | 2.60±0.20 | 0.55±0.10 | 0.50±0.25 | 0.50±0.20 | |

Performance Specifications (性能)

| | | | |
|---------------------------------|---|---|--|
| Temperature coefficient 温度系数 | ES01: 1Ω≤R≤10Ω: ±400ppm/°C 10Ω<R≤10MΩ: ±200ppm/°C ES02~ES07: 1Ω≤R≤10Ω: ±200ppm/°C 10Ω<R≤10MΩ: ±100ppm/°C | Humidity (Steady State) 恒定温热 | ±1%±(0.5%+0.1Ω)Max (最大) ±5%±(3.0%+0.1Ω) Max (最大) |
| Short-time overload 短时间过负荷 | ±1%±(1.0%+0.1Ω)Max (最大) ±5%±(2.0%+0.1Ω)Max (最大) | Dielectric withstanding voltage 绝缘耐压 | No evidence of flashover, mechanical damage, arcing or insulation breakdown 无击穿, 飞弧及可见机械性损伤 |
| Terminal Bending 端子弯曲 | ±(1.0%+0.05Ω) Max (最大) | Temperature cycling 温度循环 | ±1%±(0.5%+0.05Ω) Max (最大) ±5%±(1.0%+0.05Ω) Max (最大) |
| Solderability 可焊性 | Min 95% coverage (最少95%覆盖率) | Load life 负载寿命 | ±1%±(1.0%+0.1Ω) Max (最大) ±5%±(3.0%+0.1Ω) Max (最大) |
| Soldering heat 耐焊接热 | ±(1.0%+0.05Ω) Max (最大) | ESD 抗静电 | ±(1.0%+0.05Ω) Max (最大) |

ESD Limiting Voltage Curve (抗静电曲线)

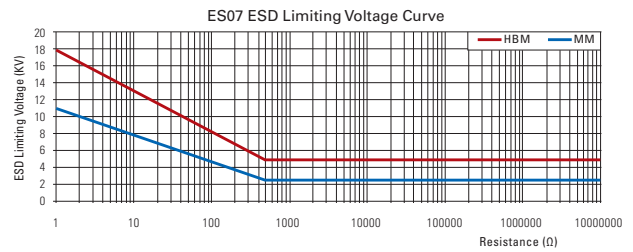
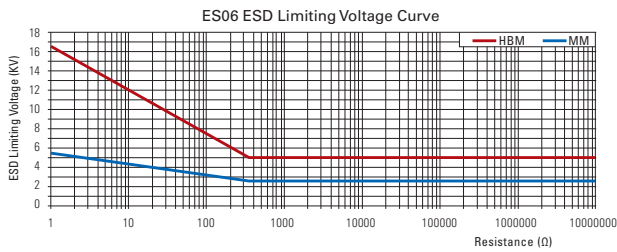
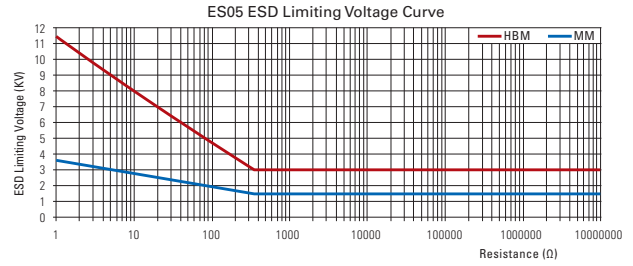
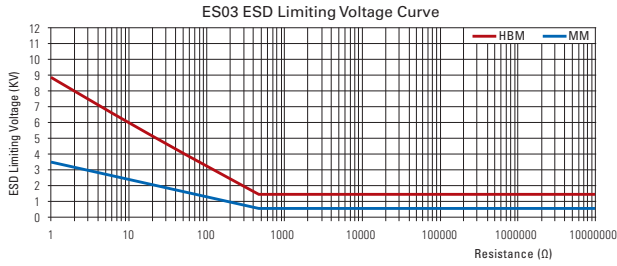
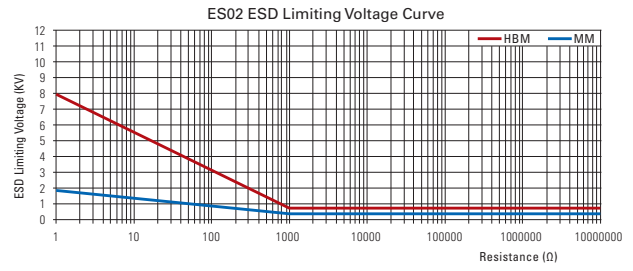
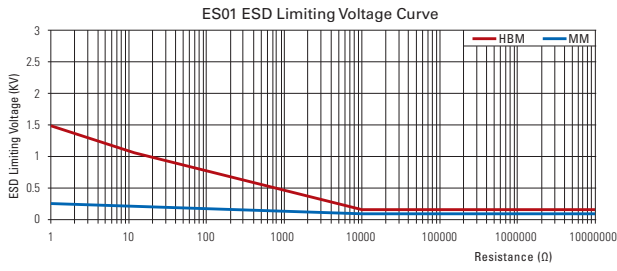

NOTE 备注: HBM:100PF 1K5 1Cycle; MM:200PF 0Q 1Cycle

Ordering Procedure (Example: ES06 2/3W 5% 1.2Ω T/R-5000)

订购方式 (例如: ES06 2/3W 5% 1.2Ω T/R-5000)

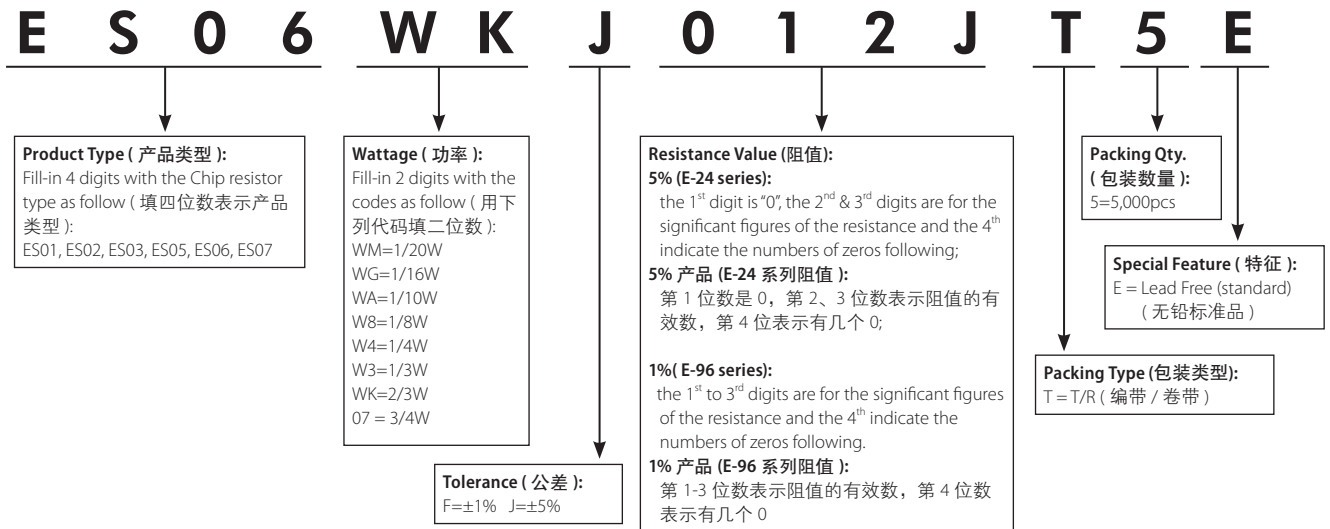

Feature (特性)

- Non-magnetic 无磁性
- Suitable for reflow & wave soldering 适合波峰焊与回流焊
- Application Mobile Phone, PDA, Setbox, Meter 适用于移动电话、PDA、机顶盒、仪表



Figures (型状)

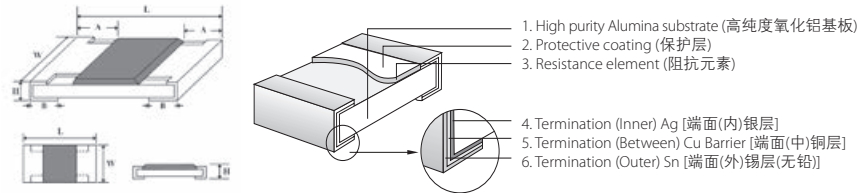

Derating Curve (降功率曲线)



Specification (性能)

| Type 类型 | Size 尺寸 | Max working voltage 最大工作电压 | Max Overload Voltage 最大过负荷电压 | Operating Temperature 工作温度范围 |
|---------|-------------|----------------------------|------------------------------|------------------------------|
| NM02 | 0402 (1005) | 50V | 100V | -55~+155°C |
| NM03 | 0603 (1608) | 75V | 150V | |
| NM05 | 0805 (2012) | 150V | 300V | |
| NM06 | 1206 (3216) | 200V | 400V | |
| NM12 | 2512 (6432) | 200V | 500V | |

| Type 类型 | Power 功率 (70°C) | L (mm) | W (mm) | H (mm) | A (mm) | B (mm) | Resistance Range 阻值范围 1%(E96), 5%(E24) |
|---------|-----------------|-----------|--|-----------|-----------|-----------|---|
| NM02 | 1/16W | 1.00±0.10 | 0.50±0.05 | 0.35±0.05 | 0.20±0.10 | 0.25±0.10 | 1Ω~10M |
| NM03 | 1/10W | 1.60±0.10 | 0.80±0.10 | 0.45±0.10 | 0.30±0.20 | 0.30±0.20 | |
| NM05 | 1/8W | 2.00±0.15 | 1.25 ^{+0.15} _{-0.10} | 0.55±0.10 | 0.40±0.20 | 0.40±0.20 | |
| NM06 | 1/4W | 3.10±0.15 | 1.55 ^{+0.15} _{-0.10} | 0.55±0.10 | 0.45±0.20 | 0.45±0.20 | |
| NM12 | 1W | 6.35±0.10 | 3.20±0.20 | 0.55±0.10 | 0.60±0.25 | 0.50±0.20 | |

Performance Specification (性能)

| | |
|--------------------------------------|--|
| Temperature coefficient 温度系数 | 1Ω≤R≤10 Ω: ±400ppm/°C 10Ω<R≤100 Ω: ±200ppm/°C R>100Ω: ±100ppm /°C |
| Short-time overload 短时间过负荷 | ±1%:±(1.0%+0.1Ω)Max.(最大) ±5%:±(2.0%+0.1Ω)Max.(最大) |
| Terminal bending 端子弯曲 | ±(1.0%+0.05Ω)Max.(最大) |
| Solderability 可焊性 | Min. 95% Coverage (最少 95% 覆盖率) |
| Soldering heat 耐焊接热 | ±(1.0%+0.05Ω) Max.(最大) |
| Humidity (Steady State) 恒定湿热 | ±1%:±(0.5%+0.1Ω)Max.(最大) ±5%:±(3.0%+0.1Ω) Max.(最大) |
| Dielectric withstanding voltage 绝缘耐压 | No evidence of flashover, mechanical damage, arcing or insulation breakdown 无击穿, 飞弧及可见机械性损伤 |
| Temperature Cycling 温度循环 | ±1%:±(0.5%+0.05Ω) Max.(最大) ±5%:±(1.0%+0.05Ω) Max.(最大) |
| Load life 负载寿命 | ±1%:±(1.0%+0.1Ω) Max.(最大) ±5%:±(3.0%+0.1Ω) Max.(最大) |

Ordering Procedure (Example: NM02 1/16W 5% 1.2 Ω T/R-10000)

订购方式 (例如: NM02 1/16W 5% 1.2 Ω T/R-10000)

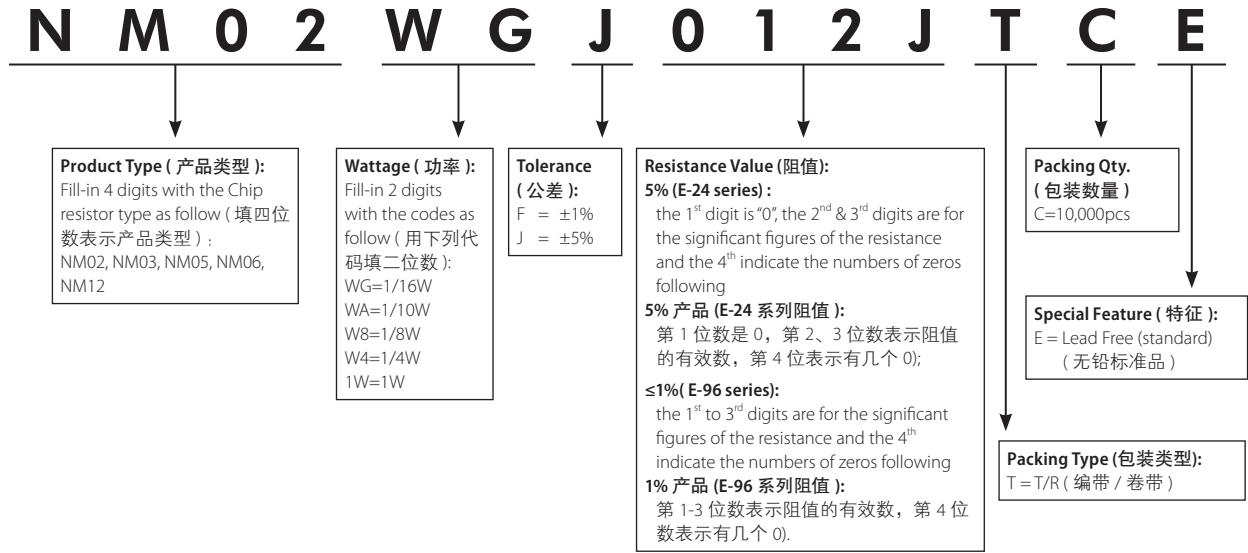

Feature (特性)

- Total Lead Free in whole resistor body 电阻本体完全不含铅
- Small size and light weight 体积小、重量轻
- Reduction of assembly costs and matching with placement machine 可降低装置成本及配合机器组装
- Suitable for both wave & re-flow soldering 适合波峰焊与回流焊



Figures (型状)

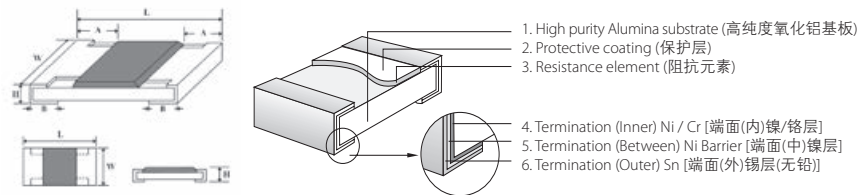

Derating Curve (降功率曲线)

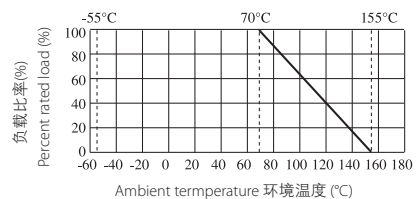

| Type 类型 | PF0A | PF01 | PF02 | PF03 | PF05 | PF06 | PF07 | PF11 | PF10 | PF12 |
|---|-----------------|----------------|----------------|----------------|----------------|----------------|----------------|----------------|----------------|----------------|
| Size 尺寸 | 01005 (0402) | 0201 (0603) | 0402 (1005) | 0603 (1608) | 0805 (2012) | 1206 (3216) | 1210 (3225) | 1812 (4532) | 2010 (5025) | 2512 (6432) |
| Max. Working Voltage 最大工作电压 | 15V | 25V | 50V | 75V | 150V | 200V | 200V | 200V | 200V | 200V |
| Max. Overload Voltage 最大过负荷电压 | 30V | 50V | 100V | 150V | 300V | 400V | 500V | 500V | 500V | 500V |
| Dielectric Withstanding Voltage 绝缘耐压 | - | - | 100V | 300V | 500V | 500V | 500V | 500V | 500V | 500V |
| Operating Temperature 工作温度范围 | -55~+155°C | | | | | | | | | |

| Type 类型 | PF0A | PF01 | PF02 | PF03 | PF05 | PF06 | PF07 | PF11 | PF10 | PF12 | |
|--|----------|-----------|-----------|-----------|-----------|--|--|-----------|-----------|-----------|-----------|
| Power Rating at 70°C 功率 | 1/32W | 1/20W | 1/16W | 1/10W | 1/8W | 1/4W | 1/2W | 3/4W | 3/4W | 1W | |
| Dimension 尺寸 | L(mm) | 0.40±0.02 | 0.60±0.03 | 1.00±0.10 | 1.60±0.10 | 2.0±0.15 | 3.10±0.15 | 3.10±0.10 | 4.50±0.20 | 5.00±0.10 | 6.35±0.10 |
| | W(mm) | 0.20±0.02 | 0.30±0.03 | 0.50±0.05 | 0.80±0.10 | 1.25 ^{+0.15} _{-0.10} | 1.55 ^{+0.15} _{-0.10} | 2.60±0.20 | 3.20±0.20 | 2.50±0.20 | 3.20±0.20 |
| | H(mm) | 0.13±0.02 | 0.23±0.03 | 0.35±0.05 | 0.45±0.10 | 0.55±0.10 | 0.55±0.10 | 0.55±0.10 | 0.55±0.20 | 0.55±0.10 | 0.55±0.10 |
| | A(mm) | 0.10±0.05 | 0.10±0.05 | 0.20±0.10 | 0.30±0.20 | 0.40±0.20 | 0.45±0.20 | 0.50±0.25 | 0.50±0.20 | 0.60±0.25 | 0.60±0.25 |
| | B(mm) | 0.10±0.03 | 0.15±0.05 | 0.25±0.10 | 0.30±0.20 | 0.40±0.20 | 0.45±0.20 | 0.50±0.20 | 0.50±0.20 | 0.50±0.20 | 0.50±0.20 |
| Resistance Value of Jumper 零欧姆电阻阻值 | <50mΩ | | | | | | | | | | |
| Rated Current of Jumper 零欧姆电阻额定电流 | 0.5A | 0.5A | 1A | 1A | 2A | 2A | 2A | 2A | 2A | 2A | |
| Max. Overload Current of Jumper 零欧姆电阻最大过负荷电流 | 1A | 1A | 2A | 2A | 5A | 10A | 10A | 10A | 10A | 10A | |
| Resistance Range of 1% (E-96) 1% 的阻值范围 (E-96) | 10Ω~10MΩ | | | | | 1Ω~10MΩ | | | | | |
| Resistance Range of 5% (E-24) 5% 的阻值范围 (E-24) | 1Ω~10MΩ | | | | | | | | | | |

Performance Specifications (性能)

| | | |
|---------------------------------|--------|---|
| | | PF0A: 1Ω≤R≤10Ω: ±600ppm/°C 10Ω<R≤100Ω: ±400ppm/°C >100Ω: ±250ppm/°C |
| Temperature coefficient | 温度系数 | PF01: 1Ω≤R≤10Ω: ±400ppm/°C >10Ω: ±200ppm/°C PF02,PF03,PF05,PF06,PF07,PF10,PF11,PF12: 1Ω≤R≤10Ω: ±400ppm/°C 10Ω<R≤100Ω: ±200ppm/°C >100Ω: ±100ppm/°C |
| Short-time overload | 短时间过负荷 | ±5%, ±2%: ±(2.0% + 0.1Ω) Max(最大). ±1%, ±0.5%: ±(1.0% + 0.1Ω) Max(最大). PF0A : ±(2.0% + 0.1Ω) Max(最大). |
| Insulation resistance | 绝缘电阻 | ≥ 1,000 MΩ |
| Dielectric withstanding voltage | 绝缘耐压 | No evidence of flashover, mechanical damage, arcing or insulation breakdown 无击穿, 飞弧及可见机械性损伤 |
| Terminal bending | 端子弯曲 | ±(1.0% + 0.05Ω) Max(最大). |
| Soldering heat | 耐焊接热 | ±(1.0% + 0.05Ω) Max(最大). |
| Solderability | 可焊性 | Min. 95% coverage (最少 95% 覆盖率) |
| Temperature cycling | 温度循环 | ±5%, ±2%: ±(1.0% + 0.05Ω) Max(最大). ±1%, ±0.5%: ±(0.5% + 0.05Ω) Max(最大). PF0A : ±(1.0% + 0.05Ω) Max(最大). |
| Humidity (Steady State) | 恒定湿热 | ±5%, ±2%: ±(3.0% + 0.1Ω) Max(最大). ±1%, ±0.5%: ±(0.5% + 0.1Ω) Max(最大). PF0A : ±(3.0% + 0.1Ω) Max(最大). |
| Load life in humidity | 湿度寿命 | ±5%, ±2%: ±(3.0% + 0.1Ω) Max(最大). ±1%, ±0.5%: ±(1% + 0.1Ω) Max(最大). PF0A : ±(3.0% + 0.1Ω) Max(最大). |
| Load life | 负载寿命 | ±5%, ±2%: ±(3.0% + 0.1Ω) Max(最大). ±1%, ±0.5%: ±(1% + 0.1Ω) Max(最大). PF0A : ±(3.0% + 0.1Ω) Max(最大). |

Ordering Procedure (Example: PF02 1/16W 5% 2.2Ω T/R-10000)

订购方式 (例如: PF02 1/16W 5% 2.2Ω T/R-10000)

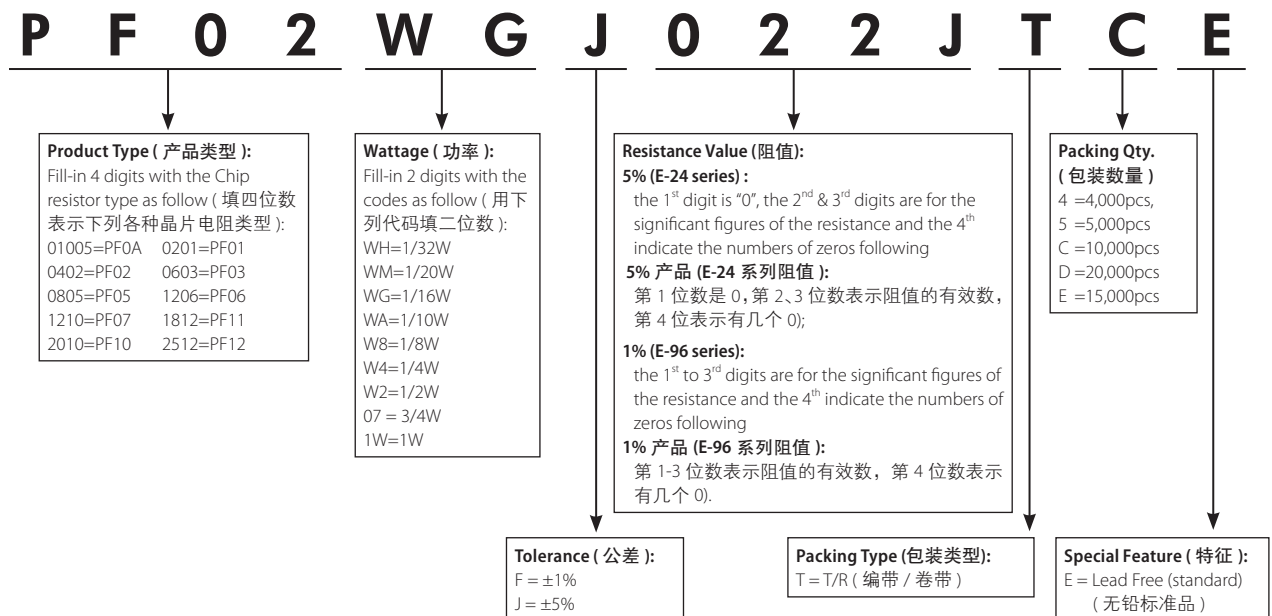

Feature (特性)

- Thin film NiCr Resistance element
薄膜镍铬阻抗组件
- Very tight tolerance $\pm 0.05\% \sim \pm 1\%$
高精度的公差 $\pm 0.05\% \sim \pm 1\%$
- Extremely low TCR $\pm 5\text{ppm} \sim \pm 50\text{ppm}$
极低的温度系数 $\pm 5\text{ppm} \sim \pm 50\text{ppm}$
- Completed Lead-free 完全无铅产品

Application (应用)

- Medical Equipment 医疗器材
- Testing / Measurement Equipment 检测仪器
- Communication Device, Cell Phone, GPS, PDA,
通讯用具, 手机, GPS, PDA
- Automatic equipment controller 自动化设备控制器
- Printer Equipment 打印机材
- Converters 变频器



Figures (型状)

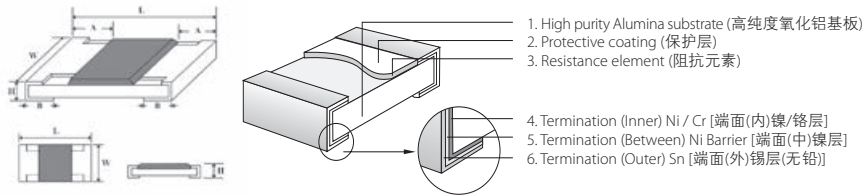

Derating Curve (降功率曲线)

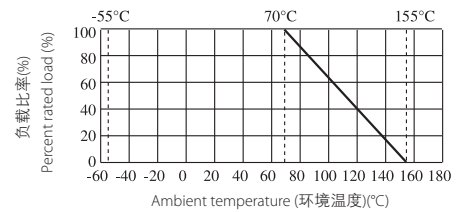

| Type 类型 | Size 尺寸 | L (mm) | W (mm) | H (mm) | A (mm) | B (mm) |
|---------|-------------|-----------|--|-----------|-----------|-----------|
| TC02 | 0402 (1005) | 1.00±0.10 | 0.50±0.05 | 0.35±0.05 | 0.20±0.10 | 0.25±0.10 |
| TC03 | 0603 (1608) | 1.60±0.10 | 0.80±0.10 | 0.45±0.10 | 0.30±0.20 | 0.30±0.20 |
| TC05 | 0805 (2012) | 2.00±0.15 | 1.25 ^{+0.15} _{-0.10} | 0.55±0.10 | 0.40±0.20 | 0.40±0.20 |
| TC06 | 1206 (3216) | 3.10±0.15 | 1.55 ^{+0.15} _{-0.10} | 0.55±0.10 | 0.45±0.20 | 0.45±0.20 |
| TC07 | 1210 (3225) | 3.10±0.10 | 2.60±0.20 | 0.55±0.10 | 0.45±0.20 | 0.45±0.20 |
| TC10 | 2010 (5025) | 5.00±0.10 | 2.50±0.20 | 0.55±0.10 | 0.60±0.25 | 0.50±0.20 |
| TC12 | 2512 (6432) | 6.35±0.10 | 3.20±0.20 | 0.55±0.10 | 0.60±0.25 | 0.50±0.20 |

Performance Specifications (性能)

| | | | |
|----------------------------|--|------------------------------|----------------------------------|
| Short-time overload 短时间过负荷 | $\Delta R \leq \pm 0.5\%$ | Humidity (Steady State) 恒定湿热 | $\Delta R \leq \pm 0.3\%$ |
| Insulation Resistance 绝缘电阻 | $\geq 1,000\text{M}\Omega$ | Terminal bending 端子弯曲 | $\Delta R \leq \pm 0.2\%$ |
| Load life humidity 湿度寿命 | $\Delta R \leq \pm 0.5\%$ | Solderability 可焊性 | Min 95% coverage (最少 95% 覆盖率) |
| Load life 负载寿命 | $\Delta R \leq \pm 0.2\%$ $> 7\text{K}\Omega \Delta R \leq \pm 0.5\%$ | Soldering heat 耐焊接热 | $\Delta R \leq \pm 0.2\%$ |

Feature (特性)

| Type 类型 | Power Rating 功率 at 70°C | Operating Temperature 工作温度范围 | Max.Working Voltage 最大工作 电压 | Max.Overload Voltage 最大过负荷 电压 | Dielectric With-standing Voltage 绝缘耐压 | Resistance Range 阻值范围 | | | | TCR 温度系数 |
|------------|-------------------------------|------------------------------------|--------------------------------------|--|--|-----------------------|------------|-----------|-----------|-------------|
| | | | | | | ±0.05% | ±0.1% | ±0.25% | ±0.5% ±1% | |
| TC02 | 1/16W | -55°C~+155°C | 25V | 50V | 100V | / | 100Ω~2KΩ | 100Ω~2KΩ | 100Ω~2KΩ | ±5PPM/°C |
| | | | | | | / | 50Ω~12KΩ | 50Ω~12KΩ | 50Ω~12KΩ | ±10PPM/°C |
| | | | | | | / | 10Ω~332KΩ | 10Ω~332KΩ | 10Ω~332KΩ | ±25PPM/°C |
| | | | | | | / | 10Ω~332KΩ | 10Ω~332KΩ | 10Ω~332KΩ | ±50PPM/°C |
| TC03 | 1/10W | -55°C~+155°C | 75V | 150V | 300V | / | 100Ω~4KΩ | 100Ω~4KΩ | 100Ω~4KΩ | ±5PPM/°C |
| | 1/6W | | | | | / | 10Ω~50KΩ | 10Ω~50KΩ | 10Ω~50KΩ | ±10PPM/°C |
| | | | | | | 4.7Ω~332K | 4.7Ω~1MΩ | 1.5Ω~1MΩ | 1Ω~1MΩ | ±25PPM/°C |
| TC05 | 1/8W | -55°C~+155°C | 150V | 300V | 500V | / | 100Ω~10KΩ | 100Ω~10KΩ | 100Ω~10KΩ | ±5PPM/°C |
| | 1/4W | | | | | / | 10Ω~100KΩ | 10Ω~100KΩ | 10Ω~100KΩ | ±10PPM/°C |
| | | | | | | 4.7Ω~511K | 4.7Ω~2MΩ | 1Ω~2MΩ | 1Ω~2MΩ | ±25PPM/°C |
| | | | | | | 4.7Ω~511K | 4.7Ω~2MΩ | 1Ω~2MΩ | 1Ω~2MΩ | ±50PPM/°C |
| TC06 | 1/4W | -55°C~+155°C | 200V | 400V | 500V | / | 100Ω~15KΩ | 100Ω~15KΩ | 100Ω~15KΩ | ±5PPM/°C |
| | 1/3W | | | | | / | 10Ω~200KΩ | 10Ω~200KΩ | 10Ω~200KΩ | ±10PPM/°C |
| | | | | | | 4.7Ω~1M | 4.7Ω~2.5MΩ | 1Ω~2.5MΩ | 1Ω~2.5MΩ | ±25PPM/°C |
| | | | | | | 4.7Ω~1M | 4.7Ω~2.5MΩ | 1Ω~2.5MΩ | 1Ω~2.5MΩ | ±50PPM/°C |
| TC07 | 1/3W | -55°C~+155°C | 200V | 400V | 500V | / | 100Ω~25KΩ | 100Ω~25KΩ | 100Ω~25KΩ | ±5PPM/°C |
| | | | | | | / | 50Ω~200KΩ | 50Ω~200KΩ | 50Ω~200KΩ | ±10PPM/°C |
| | | | | | | 4.7Ω~1M | 4.7Ω~2.5MΩ | 1Ω~2.5MΩ | 1Ω~2.5MΩ | ±25PPM/°C |
| | | | | | | 4.7Ω~1M | 4.7Ω~2.5MΩ | 1Ω~2.5MΩ | 1Ω~2.5MΩ | ±50PPM/°C |
| TC10 | 1/3W | -55°C~+155°C | 200V | 400V | 500V | / | 100Ω~25KΩ | 100Ω~25KΩ | 100Ω~25KΩ | ±5PPM/°C |
| | 1/2W | | | | | / | 50Ω~200KΩ | 50Ω~200KΩ | 50Ω~200KΩ | ±10PPM/°C |
| | | | | | | 4.7Ω~1M | 4.7Ω~3MΩ | 1Ω~3MΩ | 1Ω~3MΩ | ±25PPM/°C |
| | | | | | | 4.7Ω~1M | 4.7Ω~3MΩ | 1Ω~3MΩ | 1Ω~3MΩ | ±50PPM/°C |
| TC12 | 3/4W | -55°C~+155°C | 200V | 400V | 500V | / | 100Ω~25KΩ | 100Ω~25KΩ | 100Ω~25KΩ | ±5PPM/°C |
| | 1W | | | | | / | 50Ω~200KΩ | 50Ω~200KΩ | 50Ω~200KΩ | ±10PPM/°C |
| | | | | | | 10Ω~1M | 10Ω~3MΩ | 10Ω~3MΩ | 10Ω~3MΩ | ±25PPM/°C |
| | | | | | | 10Ω~1M | 10Ω~3MΩ | 10Ω~3MΩ | 10Ω~3MΩ | ±50PPM/°C |
| | | | | | | 4.7Ω~9.76Ω | 4.7Ω~10Ω | 1Ω~10Ω | 1Ω~10Ω | ±25PPM/°C |
| | | | | | | 4.7Ω~9.76Ω | 4.7Ω~10Ω | 1Ω~10Ω | 1Ω~10Ω | ±50PPM/°C |
| 1/2W | | | | | | | | | | |

Ordering Procedure (Example:Thin Film TC06 1/3W 0.1% 25PPM 1KΩ T/R-5000)

订购方式(例如: 薄膜TC06 1/3W 0.1% 25PPM 1KΩ T/R-5000)

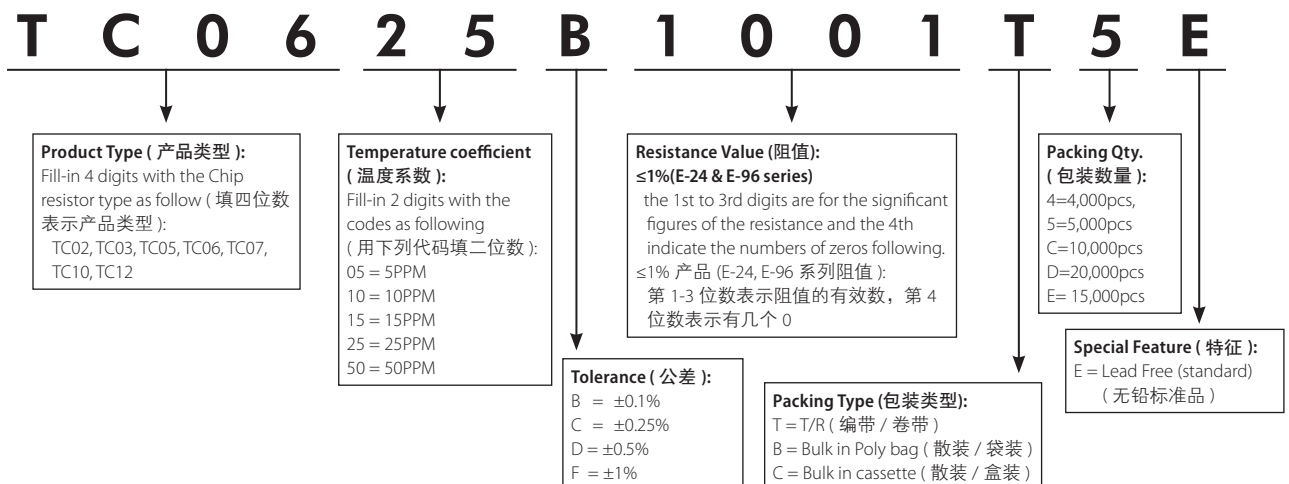

Feature (特性)

- Ultra-low Value
超低阻值
- Low Temperature Coefficient
低温度系数
- Suitable for reflow & wave soldering
适合波峰焊及回流焊
- Application: Power supply
应用于电源

Figures (型状)

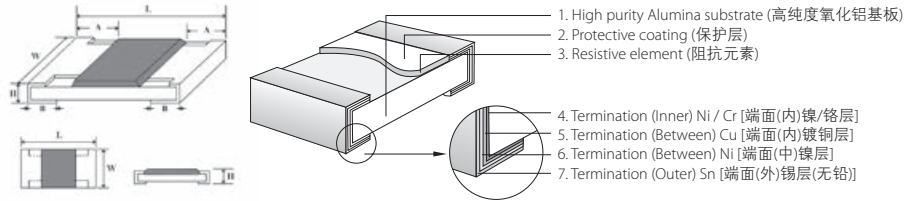

Derating Curve & Specification (降功率曲线及性能)

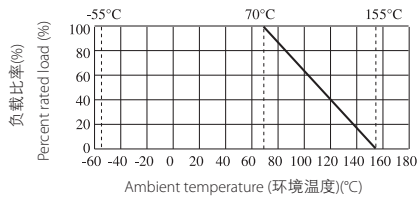

| Type 类型 | Dielectric Withstanding Voltage 绝缘耐压 | Operating Temperature 工作温度范围 |
|------------|---|---------------------------------|
| CS02 | 100V | -55°C~155°C |
| CS03 | 300V | -55°C~155°C |
| CS05 | 500V | -55°C~155°C |
| CS06 | 500V | -55°C~155°C |
| CS07 | 500V | -55°C~155°C |
| CS10 | 500V | -55°C~155°C |
| CS11 | 500V | -55°C~155°C |
| CS12 | 500V | -55°C~155°C |

| Type 类型 | Size 尺寸 | Power Rating 功率 70°C | L(mm) | W(mm) | H(mm) | A(mm) | B(mm) | Resistance Range 阻值范围 1% & 5% | T.C.R. 温度系数 |
|------------|----------------|----------------------------|-------------|--|-----------|-----------|-----------|-------------------------------------|--|
| CS02 | 0402 (1005) | 1/8W | 1.00±0.10 | 0.50±0.05 | 0.35±0.05 | 0.20±0.10 | 0.25±0.10 | 50mΩ~1Ω | 50mΩ≤R<100mΩ: ±700 ppm/°C 100mΩ≤R≤1Ω: ±200 ppm/°C |
| CS03 | 0603 (1608) | 1/5W | 1.60±0.10 | 0.80±0.10 | 0.45±0.10 | 0.30±0.20 | 0.30±0.20 | 20mΩ~1Ω | 20mΩ≤R<30mΩ: ±800 ppm/°C 30mΩ≤R<33mΩ: ±600 ppm/°C 33mΩ≤R≤50mΩ: ±400 ppm/°C 50mΩ<R≤0.1Ω: ±300 ppm/°C 0.1Ω<R≤1Ω: ±200 ppm/°C |
| CS05 | 0805 (2012) | 1/4W | 2.00±0.15 | 1.25 ^{+0.15} _{-0.10} | 0.55±0.10 | 0.40±0.20 | 0.40±0.20 | 10mΩ~1Ω | 10mΩ≤R≤15mΩ: ±800 ppm/°C 15mΩ<R≤25mΩ: ±600 ppm/°C 25mΩ<R≤50mΩ: ±400 ppm/°C 50mΩ<R≤0.2Ω: ±200 ppm/°C 0.2Ω<R≤1Ω: ±100 ppm/°C |
| CS06 | 1206 (3216) | 1/3W | 3.10±0.15 | 1.55 ^{+0.15} _{-0.10} | 0.55±0.10 | 0.45±0.20 | 0.45±0.20 | 10mΩ~1Ω | 10mΩ≤R<15mΩ: ±700ppm/°C 15mΩ≤R≤30mΩ: ±400ppm/°C 30mΩ<R≤50mΩ: ±300ppm/°C 50mΩ<R≤0.1Ω: ±200ppm/°C 0.1Ω<R≤1Ω: ±150ppm/°C |
| CS07 | 1210 (3225) | 1/2W | 3.10+/-0.10 | 2.60±0.20 | 0.55±0.10 | 0.50±0.25 | 0.50±0.20 | 10mΩ~1Ω | 10mΩ≤R<15mΩ: ±500ppm/°C 15mΩ≤R<20mΩ: ±400ppm/°C 20mΩ≤R≤50mΩ: ±300ppm/°C 50mΩ<R≤1Ω: ±100ppm/°C |
| CS10 | 2010 (5025) | 3/4W | 5.00±0.10 | 2.50±0.20 | 0.55±0.10 | 0.60±0.25 | 0.50±0.20 | 10mΩ~1Ω | 10mΩ≤R<15mΩ: ±600ppm/°C 15mΩ≤R<20mΩ: ±500ppm/°C 20mΩ≤R≤30mΩ: ±300ppm/°C 30mΩ<R≤50mΩ: ±200ppm/°C 50mΩ<R≤0.1Ω: ±150ppm/°C 0.1Ω<R≤1Ω: ±100ppm/°C |
| CS11 | 1812 (4532) | 3/4W | 4.50±0.20 | 3.20±0.20 | 0.55±0.20 | 0.50±0.20 | 0.80±0.30 | 10mΩ~1Ω | 10mΩ≤R<20mΩ: ±500ppm/°C 20mΩ≤R<50mΩ: ±400ppm/°C 50mΩ≤R≤0.1Ω: ±200ppm/°C 0.1Ω<R≤1Ω: ±100ppm/°C |
| CS12 | 2512 (6432) | 1W | 6.35±0.10 | 3.20±0.20 | 0.55±0.10 | 0.60±0.25 | 0.80±0.30 | 10mΩ~1Ω | 10mΩ≤R<15mΩ: ±600ppm/°C 15mΩ≤R<20mΩ: ±400ppm/°C 20mΩ≤R≤30mΩ: ±300ppm/°C 30mΩ<R≤50mΩ: ±200ppm/°C 50mΩ<R≤0.1Ω: ±150ppm/°C 0.1Ω<R≤1Ω: ±100ppm/°C |

Performance Specifications (性能)

| | | |
|--|---------------|---|
| Short-time overload | 短时间过负荷 | 1%±(1.0%+0.005Ω) Max. (最大) 5%±(2.0%+0.005Ω) Max. (最大) |
| Terminal bending | 端子弯曲 | ±(1.0%+0.005Ω) Max. (最大) |
| Solderability | 可焊性 | Min. 95% coverage (最少95%覆盖率) |
| Dielectric withstanding Voltage | 绝缘耐压 | No evidence of flashover, mechanical damages, arcing or insulation breakdown 无击穿, 飞弧及可见机械性损伤 |
| Temperature cycling | 温度循环 | ±(1.0%+0.005Ω) Max. (最大) |
| Soldering heat | 耐焊接热 | ±(1.0%+0.005Ω) Max. (最大) |
| Load life in humidity | 湿度寿命 | 1%±(1.0%+0.005Ω) Max. (最大) 5%±(3.0%+0.005Ω) Max. (最大) |
| Load life | 负载寿命 | 1%±(1.0%+0.005Ω) Max. (最大) 5%±(3.0%+0.005Ω) Max. (最大) |

* CS07 size in 0.75W 0.1~1Ω 100PPM/°C could be provided specially (* CS07 0.75W 0.1~1Ω 100PPM/°C 可特别提供)

Ordering Procedure (Example: CS12 1W 5% 22mΩ T/R-4000)

订购方式 (例如: CS12 1W 5% 22mΩ T/R-4000)

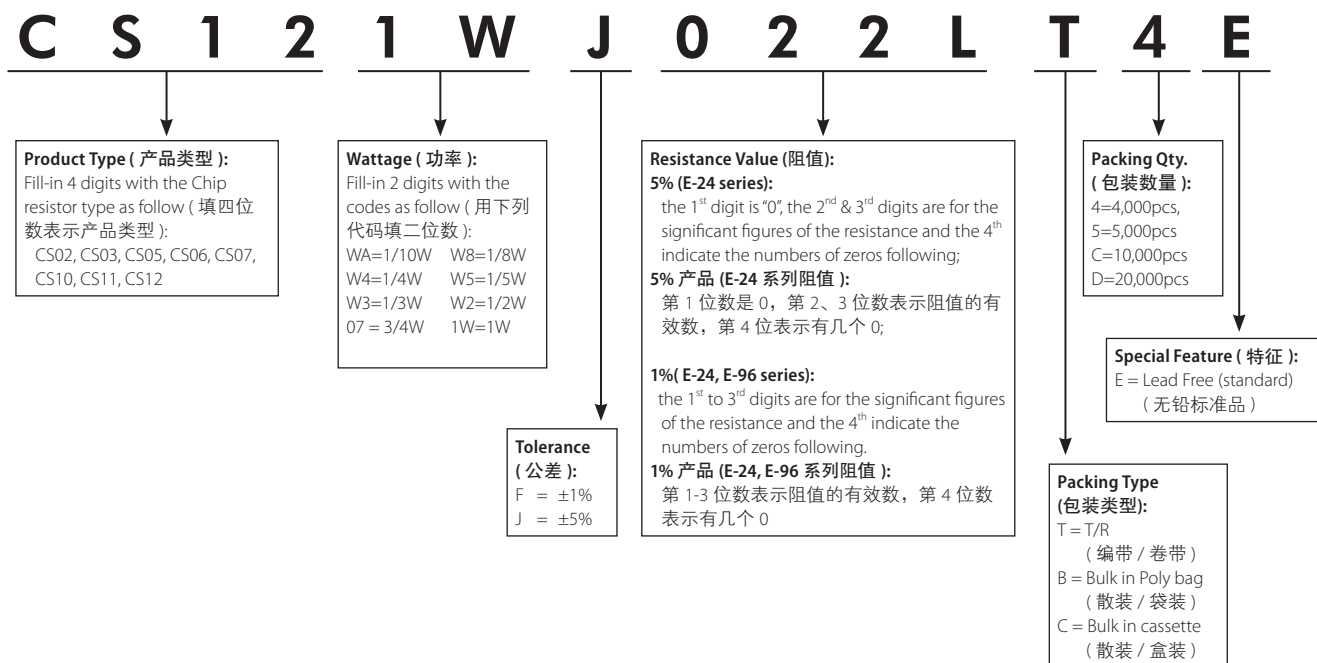

Feature (特性)

- Able to withstand high power 耐高功率
- Ultra Low sensing resistance 超低感应电阻
- Excellent frequency response 优秀的频率响应
- Excellent temperature coefficient characteristics 优秀的温度系数特性
- AEC-Q200 qualified. 符合AEC-Q200 相关条款



Application (应用)

- Mobile electronic equipment-Cellular phone, NB Tablet PC, GPS,DSC, HDD
移动电话、平板计算机、GPS、DSC、硬盘驱动器
- DC-DC converter, Adapter, Battery pack and charger
直流转换器、适配器、电池和充电器
- Switching power supply 开关电源
- Voltage Regulation module 电压调整模块
- Power management applications 电源管理应用

Derating Curve (降功率曲线)

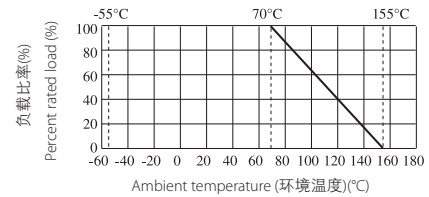

Figures (型状)

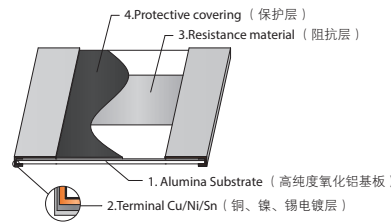
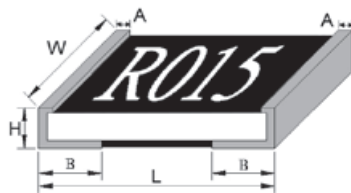

Specification (性能)

| Type 类型 | Size 尺寸 | Power Rating 功率 70°C | Dimension(尺寸)(mm) | | | | | Resistance Range 阻值范围 ±1% & ±5% | T.C.R. 温度系数 |
|------------|------------|----------------------------|---------------------|-----------|-----------|------|----------------|---------------------------------------|-------------------------------------|
| | | | L | W | H | A | B | | |
| MS05 | 0805 | 1W | 2.00±0.30 | 1.20±0.30 | 0.60±0.20 | ≤1.0 | 0.50±0.25 | 10mΩ | ±50ppm/°C ±100ppm/°C |
| | | 0.5W | | | | | | 5~30mΩ | |
| MS06 | 1206 | 1W | 3.10±0.20 | 1.60±0.30 | 0.70±0.20 | ≤1.0 | 0.50~1.00±0.25 | 5~20mΩ | ±100ppm/°C ±50ppm/°C |
| | | | | | | | | 21~51mΩ | |
| MS07 | 1210 | 1.5W | 3.10±0.20 | 2.50±0.25 | 0.70±0.20 | ≤1.0 | 0.65±0.25 | 3~150mΩ | ±30ppm/°C |
| MS11 | 1812 | 2W | 4.40±0.20 | 3.20±0.25 | 0.70±0.20 | ≤1.0 | 0.80~1.50±0.30 | 2~100mΩ | ±30ppm/°C |
| MS10 | 2010 | 1.5W | 5.00±0.20 | 2.50±0.25 | 0.70±0.20 | ≤1.0 | 0.70~1.40±0.30 | 2~10mΩ | ±50ppm/°C ±30ppm/°C |
| | | | | | | | | 11~150mΩ | |
| MS12 | 2512 | 3W | 6.35±0.20 | 3.20±0.25 | 0.70±0.20 | ≤1.0 | 1.8~2.50±0.30 | 1~2mΩ | ±50ppm/°C ±30ppm/°C ±30ppm/°C |
| | | 3W | | | | | | 3~100mΩ | |
| | | 2W | | | | | | 101~250mΩ | |
| MS28 | 2728 | 4W | 6.70±0.20 | 7.20±0.25 | 0.70±0.20 | ≤1.0 | 0.80±0.30 | 5~100mΩ | ±50ppm/°C |
| MS17 | 2817 | 3W | 7.10±0.20 | 4.20±0.20 | 0.70±0.20 | ≤1.0 | 1.10~1.50±0.30 | 3~150mΩ | ±30ppm/°C |
| | | | | | | | | 10~20mΩ | |
| MS20 | 4320 | 5W | 11.00±0.30 | 5.00±0.25 | 0.65±0.20 | ≤1.0 | 2.50±0.30 | 2~9mΩ | ±30ppm/°C |
| | | 21~50mΩ | | | | | | | |
| MS27 | 4527 | 5W | 11.60±0.30 | 6.70±0.25 | 0.60±0.20 | ≤1.0 | 2.50±0.30 | 10~30mΩ | ±30ppm/°C |
| | | 3W | | | | | | 2~9mΩ | |
| | | | 11.60±0.30 | 6.70±0.25 | 0.60±0.20 | ≤1.0 | 2.50±0.30 | 31~100mΩ | ±30ppm/°C |

* 特别提供白底黑字产品
* White background and black text on special offer product

* Other sizes and resistor values can be customized on request.
* 其他规格和阻值可特别提供

Performance Specifications (性能)

| | | |
|----------------------------------|---------------|---|
| Short-time overload | 短时间过负荷 | 1% & 2%: $\pm(1\%+0.001 \Omega)$ Max (最大) 5%: $\pm(2\%+0.001 \Omega)$ Max (最大) |
| Solderability | 可焊性 | Min 95% coverage (最少95%覆盖率) |
| Temperature cycling | 温度循环 | $\pm(0.5\%+0.005\Omega)$ Max. (最大) |
| Low Temperature Storage | 低温放置 | $\pm(1\%+0.001 \Omega)$ Max. (最大) |
| High Temperature Exposure | 高温放置 | $\pm(1\%+0.001 \Omega)$ Max. (最大) |
| Soldering heat | 耐焊接热 | $\pm(0.5\%+0.005\Omega)$ Max. (最大) |
| Load life in humidity | 湿度寿命 | 1% & 2%: $\pm(1\%+0.001 \Omega)$ Max. (最大) 5%: $\pm(3\%+0.001 \Omega)$ Max. (最大) |
| Load life | 负载寿命 | 1% & 2%: $\pm(1\%+0.001 \Omega)$ Max. (最大) 5%: $\pm(3\%+0.001 \Omega)$ Max. (最大) |
| Biased Humidity | 偏置湿度 | 1% & 2%: $\pm(1\%+0.001 \Omega)$ Max (最大) 5%: $\pm(3\%+0.001 \Omega)$ Max (最大) |

Ordering Procedure (Example: MS12 3W 1% 10m Ω T/R-4000)

订购方式 (例如: MS12 3W 1% 10m Ω T/R-4000)

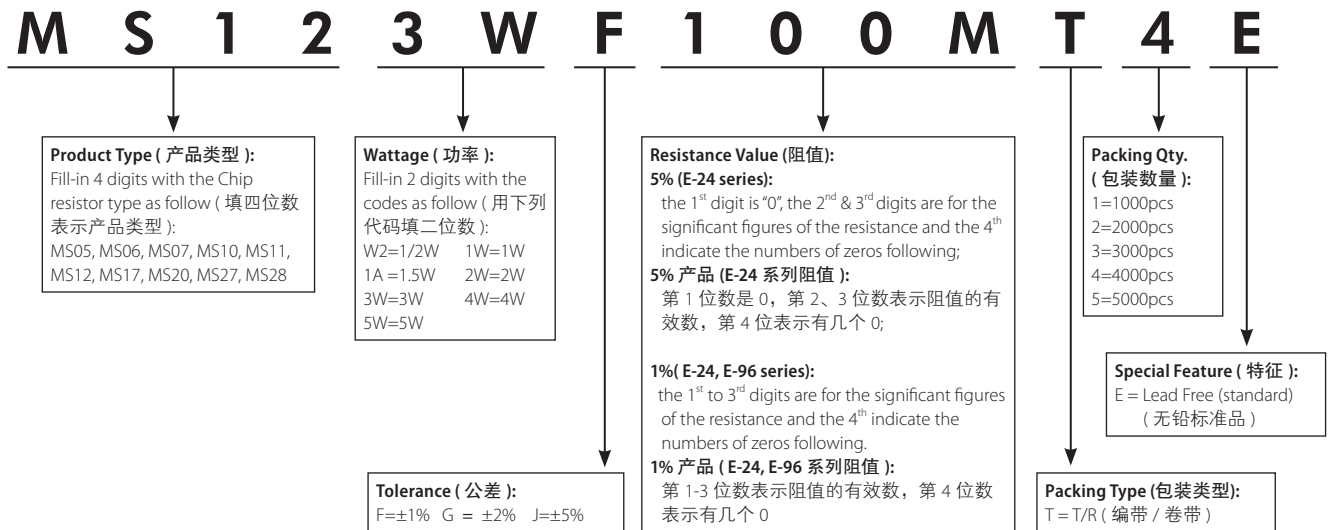

注: 下单规则请见 P139

Feature (特性)

- High power rating up to 3 watts 高功率可达 3W
- Low T.C.R until ± 50 PPM 较低的温度系数 ± 50 PPM
- Low resistance values, from 0.5m Ω to 15m Ω 阻值低 0.5m Ω ~15m Ω
- Wide range package size 1206/2010/2512 尺寸为 1206、2010、2512
- Tolerance: $\pm 1\%$, $\pm 2\%$, $\pm 5\%$ 精度: $\pm 1\%$, $\pm 2\%$, $\pm 5\%$

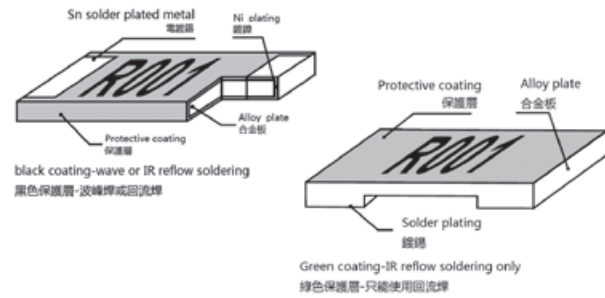

Derating Curve (降功率曲线)

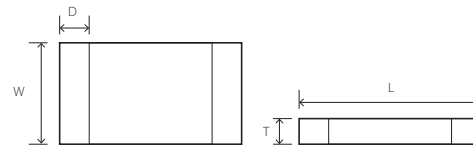
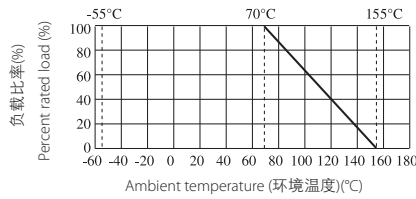

| Type 类型 | Power Rating at 70°C 额定功率 | T.C.R PPM/°C | Resistance Range(m Ω) 阻值范围 | Dimension(mm) 尺寸 | | | | Color 颜色 | Soldering 焊接 |
|------------------------------|---------------------------------|-----------------|--|------------------|------------------|------------------------------|------------------------------|-------------|---|
| | | | | L | W | T | D | | |
| Standard 标准 | | | | | | | | | |
| LR06 (1206) | 1W | ± 200 | 0.5 | 3.20 \pm 0.254 | 1.60 \pm 0.104 | 0.60 \pm 0.20 | 0.980 \pm 0.380 | Black 黑色 | IR reflow 回流焊 |
| | | ± 50 | 0.75~10 | | | | | | |
| LR12 (2512) | 1W | ± 150 | 2,5,3 | 6.35 \pm 0.254 | 3.18 \pm 0.254 | Depends on value 由阻值决定 | Depends on value 由阻值决定 | Black 黑色 | Wave or IR reflow 波峰焊或回流焊 |
| | | ± 100 | 4,5,10 | | | | | | |
| | | ± 75 | 6,6,5,7 | | | | | | |
| | | ± 50 | 0.5,0.75,1,1.5,2 | | | | | | |
| | | ± 50 | 11,12,13,14,15 | | | | | Green 绿色 | IR reflow 回流焊 |
| High Power Rating 高功率 | | | | | | | | | |
| LR10 (2010) | 1.5W | ± 200 | 0.5 | 5.08 \pm 0.254 | 2.54 \pm 0.15 | 0.60 \pm 0.20 | 1.665 \pm 0.625 | Black 黑色 | IR reflow 回流焊 |
| | | ± 50 | 0.75~10 | | | | | | |
| LR12 (2512) | 2.0W | ± 150 | 2,3,5 | 6.35 \pm 0.254 | 3.18 \pm 0.254 | Depends on value 由阻值决定 | Depends on value 由阻值决定 | Black 黑色 | Wave or IR reflow IR reflow 波峰焊或回流焊 |
| | | ± 100 | 4,5,10 | | | | | | |
| | | ± 75 | 6,6,5,7 | | | | | | |
| | | ± 50 | 0.5,0.75,1,1.5,2 | | | | | | |
| | | ± 50 | 6.5,7,8,9,10 | | | | | Green 绿色 | IR reflow 回流焊 |
| | 2.5W | ± 50 | 4,4,5,5,6 | | | | | Green 绿色 | IR reflow 回流焊 |
| | 3W | ± 100 | 0.5,0.75 | | | | | Green 绿色 | IR reflow 回流焊 |
| | | ± 50 | 1,1.5,2,3 | | | | | | |

Note: LR12 2W special TCR available case by case on basis.

注意: LR12 2W 特殊 TCR 可以特别提供。

Standard Operating Temp -55°C~+170°C

标准的工作温度 -55°C ~ +170°C

Performance Specifications (性能)

| | | |
|-------------------------------------|---------------|--|
| Short-time overload | 短时间过负荷 | Black coating 黑色涂层 :±0.5% Max(最大) Green coating 绿色涂层 :±1% Max(最大) |
| Resistance to Soldering heat | 耐焊接热 | Black coating 黑色涂层 :±0.5% Max(最大) Green coating 绿色涂层 :±1% Max(最大) |
| Solderability | 可焊性 | Min.95% coverage (最少 95% 覆盖) |
| Thermal Shock | 热冲击 | Black coating 黑色涂层 :±0.5% Max(最大) Green coating 绿色涂层 :±1% Max(最大) |
| Load life | 负载寿命 | ±1% Max(最大) |

Ordering Procedure (Example:LR12 2W 1% 5mΩ T/R-2000)

订购方式 (例如: LR12 2W 1% 5mΩ T/R-2000)

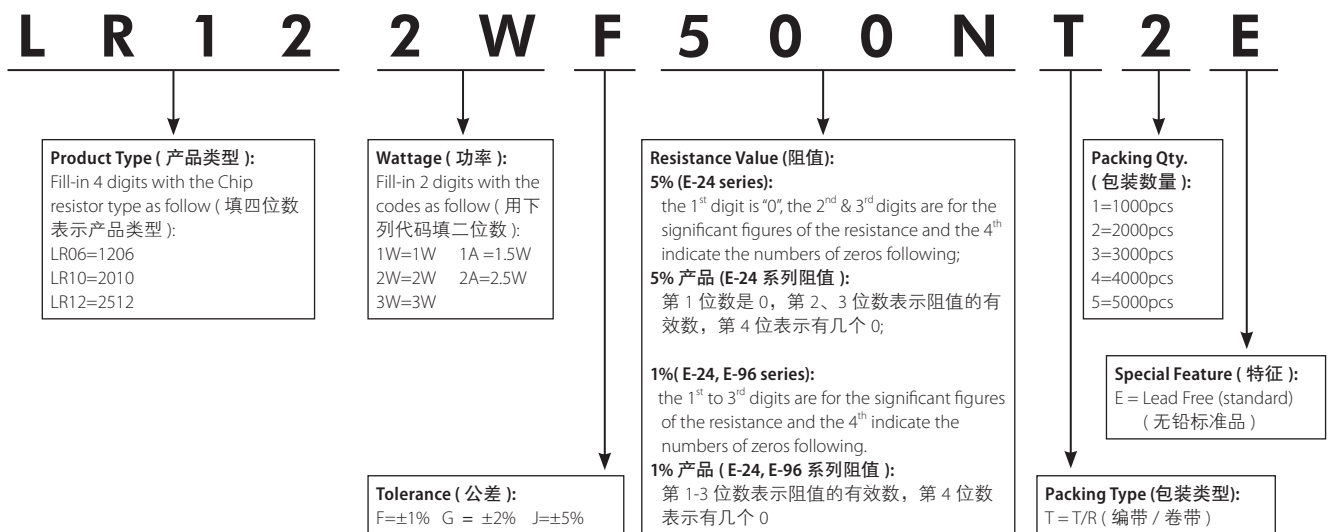

Feature (特性)

- Electron beam welding structure, stable performance
电子束焊结构，性能稳定
- Comply with ROHS standard
符合欧盟 ROHS 标准
- Very low resistance
极低电阻值

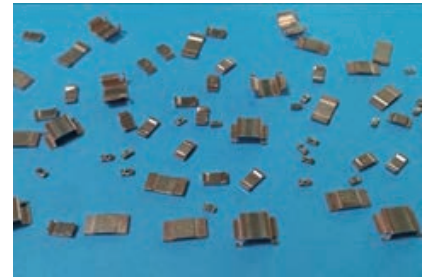

Application (应用)

- Used in automobiles, fan, lighting
应用于汽车、风机、照明
- Current module, electric welding machine, electric tool industry applications
电流模块，电焊机，电动工具领域应用
- There are two side and four end structures
有二端及四端引线结构

Derating Curve (降功率曲线)

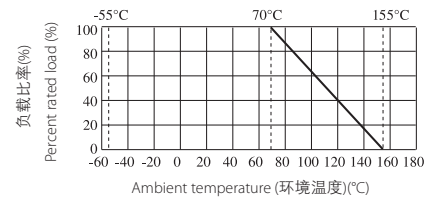

Dimension (尺寸) mm

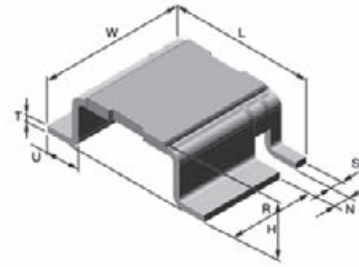
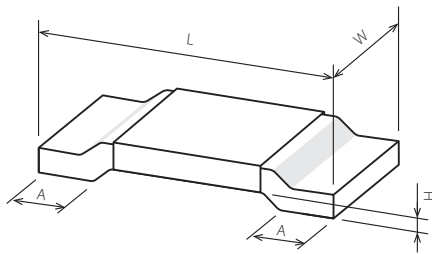

| Type 类型 | Size 规格 | Power Rating 功率 70°C | Dimension(尺寸)(mm) | | | | Resistance Range 阻值范围 ±1% | T.C.R. 温度系数 |
|------------|------------|-------------------------|---------------------|-----------|-----------|-----------|---------------------------------|----------------|
| | | | L | W | H | A | | |
| RS12 | 2512 | 3W | 6.30±0.20 | 3.10±0.30 | 0.50±0.10 | 1.20±0.20 | 0.4 ~ 1mΩ | |
| RS21 | 3921 | 5W | 10.00±0.20 | 5.10±0.40 | 0.50±0.10 | 2.20±0.20 | 0.5~ 1mΩ | ±50 ppm/°C |
| RS31 | 5931 | 7W | 15.00±0.30 | 7.60±0.40 | 0.50±0.10 | 4.20±0.30 | 0.5mΩ | |

| Type 类型 | Size 规格 | Power Rating 功率 70°C | Dimension(尺寸)(mm) | | | | | | | | Resistance Range 阻值范围 ±1% | T.C.R. 温度系数 |
|------------|------------|-------------------------|---------------------|--------------|----------|----------|----------|----------|----------|----------|---------------------------------|----------------|
| | | | L | W | H | R | S | T | U | N | | |
| RS26 | 4026 | 3W | 10.1±0.20 | 6.6+0.5/-0.2 | 3.0±0.20 | 5.2±0.20 | 0.7±0.10 | 0.4±0.10 | 2.0±0.10 | 1.0±0.15 | 0.5mΩ | ±100ppm/°C |

* 其他规格和阻值可特别提供

* Other sizes and resistor values can be customized on request.

Performance Specifications (性能)

| | | |
|---------------------------|--------|---|
| Short-time Overload | 短时间过负荷 | 1% & 2%: $\pm(1\%+0.001 \Omega)$ Max 5%: $\pm(2\%+0.001 \Omega)$ Max |
| Solderability | 可焊性 | 95% coverage (最少 95% 覆盖率) |
| Temperature cycling | 温度循环 | $\pm(1.0\%+0.005\Omega)$ Max. (最大) |
| Low Temperature Storage | 低温放置 | $\pm(1\%+0.001 \Omega)$ Max |
| High Temperature Exposure | 高温放置 | $\pm(1\%+0.001 \Omega)$ Max |
| Soldering heat | 耐焊接热 | $\pm(1.0\%+0.005\Omega)$ Max. (最大) |
| Load life in humidity | 湿度寿命 | 1% & 2%: $\pm(1\%+0.001 \Omega)$ Max 5%: $\pm(3\%+0.001 \Omega)$ Max |
| Load life | 负载寿命 | 1% & 2%: $\pm(1\%+0.001 \Omega)$ Max 5%: $\pm(3\%+0.001 \Omega)$ Max |

Ordering Procedure (Example: RS12 3W 1% 0.5m Ω T/R-1000)

订购方式 (例如: RS12 3W 1% 0.5m Ω T/R-1000)

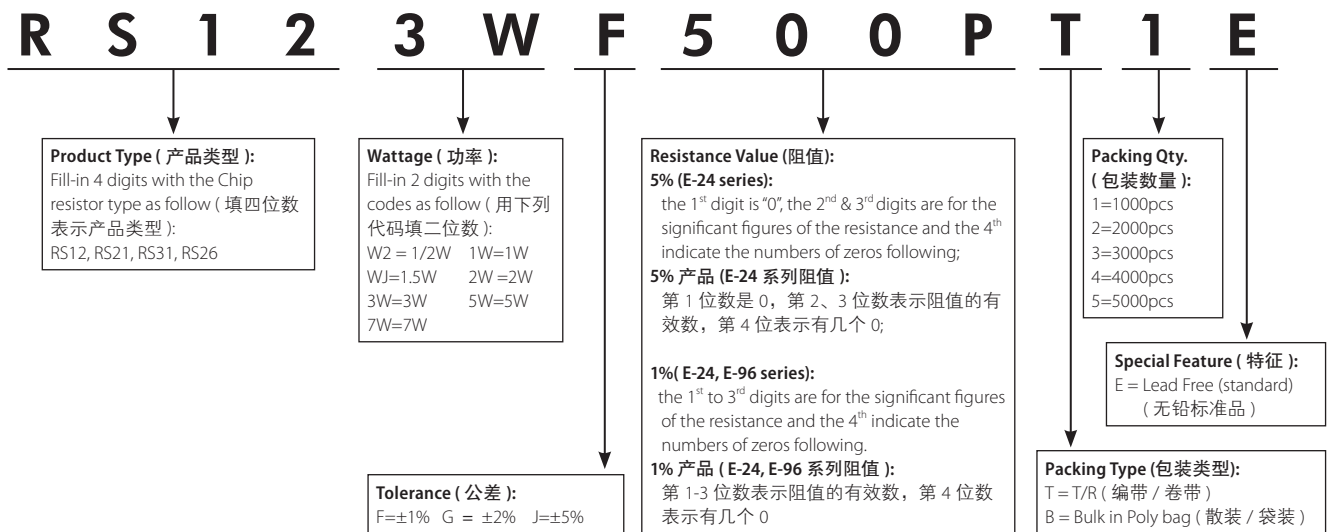

Feature (特性)

- Application automobile industry, comply with the relevant provisions of AEC-Q200, 100% power rating under +125°C
用于汽车, 符合 AEC-Q200 相关条款, +125°C 温度下 100% 功率使用
- Excellent Anti-sulfurized performance 抗硫化性能强
- Superior Anti-Surge Voltage performance 优越的抗浪涌电压特性
- Suitable for reflow & wave soldering 适合波峰焊与回流焊
- Application Car, Power Supply 适用于汽车、电源等

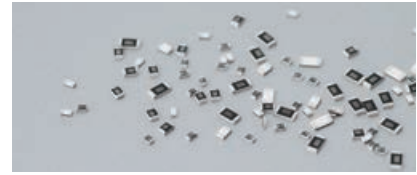

Figures (型状)

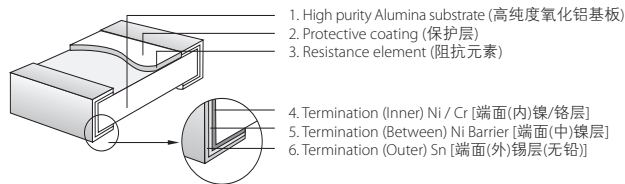
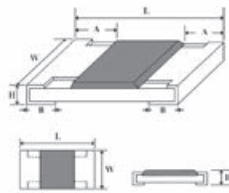

Derating Curve (降功率曲线)

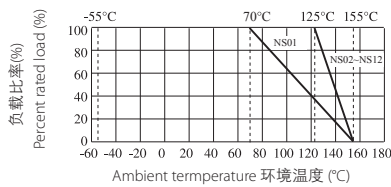

Curve of Pulse Duration (脉冲曲线)

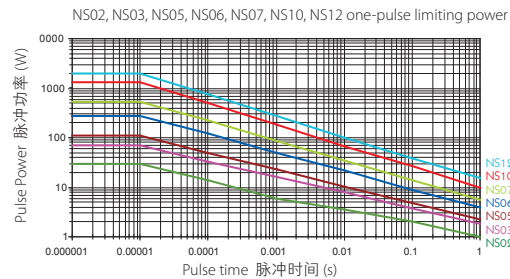

Specification (性能)

| Type 类型 | Size 尺寸 | Max working voltage 最大工作电压 | Max Overload Voltage 最大过负荷电压 | Dielectric Withstanding Voltage 绝缘耐压 | Resistance Value of Jumper 零欧姆电阻阻值 | Rated Current of Jumper 零欧姆电阻额定电流 | Max. Overload Current of Jumper 零欧姆电阻最大过负荷电流 | Operating Temperature 工作温度范围 |
|---------|-------------|----------------------------|------------------------------|--------------------------------------|------------------------------------|-----------------------------------|--|------------------------------|
| NS01 | 0201 (0603) | 25V | 50V | / | < 50mΩ | 0.5A | 1A | -55~+155°C |
| NS02 | 0402 (1005) | 50V | 100V | 100V | < 50mΩ | 1A | 2A | |
| NS03 | 0603 (1608) | 75V | 150V | 300V | < 50mΩ | 1A | 2A | |
| NS05 | 0805 (2012) | 150V | 300V | 500V | < 50mΩ | 2A | 5A | |
| NS06 | 1206 (3216) | 200V | 400V | 500V | < 50mΩ | 2A | 10A | |
| NS07 | 1210 (3225) | 200V | 500V | 500V | < 50mΩ | 2A | 10A | |
| NS10 | 2010 (5025) | 200V | 500V | 500V | < 50mΩ | 2A | 10A | |
| NS12 | 2512 (6432) | 200V | 500V | 500V | < 50mΩ | 2A | 10A | |

| Type 类型 | Power 功率 | L (mm) | W (mm) | H (mm) | A (mm) | B (mm) | Resistance Range 阻值范围 1%(E96), 5%(E24) |
|---------|----------|-----------|--|-----------|-----------|-----------|---|
| NS01 | 1/20W | 0.60±0.03 | 0.30±0.03 | 0.23±0.03 | 0.12±0.05 | 0.15±0.05 | 1Ω~10M Ω |
| NS02 | 1/16W | 1.00±0.10 | 0.50±0.05 | 0.35±0.05 | 0.20±0.10 | 0.25±0.10 | |
| NS03 | 1/10W | 1.60±0.10 | 0.80±0.10 | 0.45±0.10 | 0.30±0.20 | 0.30±0.20 | |
| NS05 | 1/8W | 2.00±0.15 | 1.25 ^{+0.15} _{-0.10} | 0.55±0.10 | 0.40±0.20 | 0.40±0.20 | |
| NS06 | 1/4W | 3.10±0.15 | 1.55 ^{+0.15} _{-0.10} | 0.55±0.10 | 0.45±0.20 | 0.45±0.20 | |
| NS07 | 1/3W | 3.10±0.10 | 2.60±0.20 | 0.55±0.10 | 0.50±0.25 | 0.50±0.20 | |
| NS10 | 3/4W | 5.00±0.10 | 2.50±0.20 | 0.55±0.10 | 0.60±0.25 | 0.50±0.20 | |
| NS12 | 1W | 6.35±0.10 | 3.20±0.20 | 0.55±0.10 | 0.60±0.25 | 0.50±0.20 | |

* Special offered 特别提供 : NS12 B:1.80±0.25mm

Performance Specification (性能)

| Test Item 试验项目 | Test Methods 试验方法 | Evaluation Criteria 判定标准 |
|---|--|---|
| Temperature coefficient 温度系数 | Measure between -55°C ~+125°C 测定范围: -55°C ~+125°C | 1Ω≤R≤10 Ω: ±400 ppm/°C 10Ω<R≤100 Ω: ±200 ppm/°C 100Ω<R≤10MΩ: ±100 ppm/°C NS01:10Ω<R≤10M: ±200 ppm/°C |
| Short-time overload 短时间过负荷 | 2.5x Rated voltage or Max. Overload Voltage whichever is lower for 5 seconds, then check the resistance. 2.5 倍额定电压或最大过负荷电压 (取其低者), 持续 5 秒钟, 然后测阻值. | ±1%±(1.0%+0.1Ω)Max (最大) ±5%±(2.0%+0.1Ω)Max (最大) |
| Terminal Bending 端子弯曲 | Bending Distance 3mm, Duration: 60s±5s, then check the resistance. 弯曲距离: 3mm, 保持时间: 60s±5s, 然后测试阻值. | ±(1.0%+0.05Ω)Max (最大) |
| Solderability 可焊性 | 245±3°C; 2~3s 245±3°C; 2~3 秒 | 95% coverage Min 覆盖率 ≥95% |
| Soldering heat 耐焊接热 | 260±5°C; 10±1s 260±5°C; 10±1 秒 | ±(1.0%+0.05Ω) Max (最大) |
| Moisture Resistance 耐湿性 | 25°C~65°C, 90~100%RH, 2.5Hr; 65°C 90~100%RH, 3Hr; 65°C~25°C 80~100%RH, 2.5Hr, 10 cycles, Measurement at 24 hours after test conclusion 25°C~65°C, 90~100%RH, 2.5 小时; 65°C 90~100%RH, 3 小时; 65°C~25°C, 80~100%RH, 2.5 小时, 10 个循环, 试验结束 24 小时后进行测试. MIL-STD-202 Method 106 | ±1%: ±(1.0%+0.1Ω)Max (最大) ±5%: ±(3.0%+0.1Ω) Max (最大) |
| Biased Humidity 偏置湿度 | 10% rated power, 85°C/85%RH, 1000Hr, Measurement at 24 hours after test conclusion 10% 额定功率, 85°C/85%RH, 持续通电 1000 小时, 试验结束 24 小时后进行测试. MIL-STD-202 Method 103 | ±1%: ±(1.0%+0.1Ω)Max (最大) ±5%: ±(3.0%+0.1Ω) Max (最大) |
| Dielectric withstanding voltage 绝缘耐压 | Resistor shall be clamped in the trough of 90° metallic V-block and shall be tested at AC potential respectively specified in the given list of each product type for 60~70s. 电阻固定在 90° 的 V 型槽中, 根据不同产品规定交流电压, 持续 60~70 秒. | No evidence of flashover, mechanical damage, arcing or insulation breakdown 无击穿, 飞弧及可见机械性损伤 |
| Temperature cycling 温度循环 | -55±3°C 30min ~normal temperature 10min-15min~155±2°C 30min~normal temperature 10min-15min, 1000 cycles, Measurement at 24 hours after test conclusion. -55±3°C(30 分钟)~ 室温(10-15 分钟)~155±2°C(30 分钟)~ 室温(10-15 分钟) 1000 个循环, 试验结束 24 小时后进行测试 JESD22 Method JA-104 | ±(1.0%+0.1Ω) Max (最大) |
| Load life 负载寿命 | NS01: 125°C, 35% power, NS02~NS12: 125°C, 100% power, at RCWV or Max.Working Voltage whichever less, 1,000 hours(1.5 hours "ON", 0.5hours"OFF"), Measurement at 24±2 hours after test conclusion. NS01: 125°C, 35% 功率, NS02~NS12: 125°C, 100% 功率, 额定工作电压或最大工作电压 (取其低者), 持续时间: 1,000 小时 (1.5 小时 "通", 0.5 小时 "断"), 试验结束 24 小时后进行测试 MIL-STD-202 Method 108 | ±1%: ±(1.0%+0.1Ω) Max (最大) ±5%: ±(3.0%+0.1Ω) Max (最大) |
| Sulfuration test 硫化测试 | Soaked in industrial oil with sulfur substance 3.5% contained 105°C ±3°C 500h 工业用油含硫成份 3.5%, 105°C±3, 500H | ΔR≤±(5%+0.1Ω) |

Ordering Procedure (Example: NS06 1/4W 5% 1.2 Ω T/R-5000)

订购方式 (例如: NS06 1/4W 5% 1.2 Ω T/R-5000)

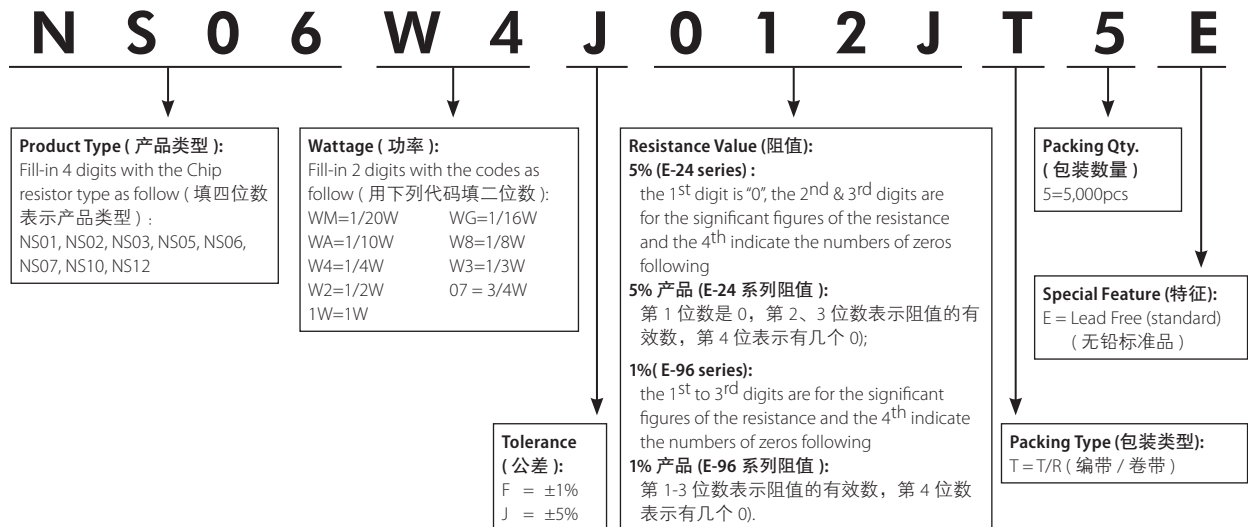

Feature (特性)

- Comply with the relevant provision of AEC-Q200, 100% power rating under +125°C
符合AEC-Q200相关条款，+125°C 温度下100%功率使用
- Suitable for reflow & wave soldering. 适合波峰焊与回流焊
- Application car. 适用于汽车

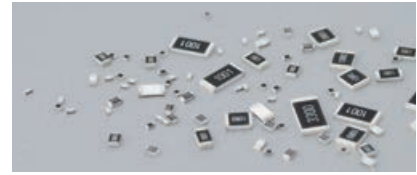

Figures (型状)

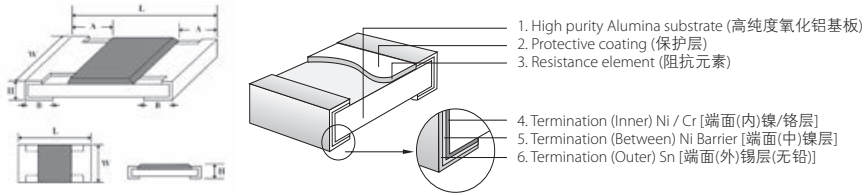

Derating Curve 降功率曲线

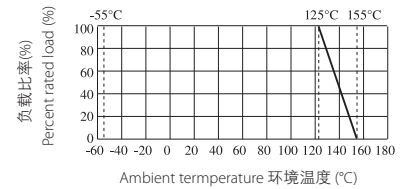

Specification (性能)

| Type 类型 | Max working voltage 最大工作电压 | Max Overload Voltage 最大过负荷电压 | Dielectric Withstanding Voltage 绝缘耐压 | Resistance Value of Jumper 零欧姆电阻阻值 | Rated Current Of Jumper 零欧姆电阻额定电流 | Max. Overload Current of Jumper 零欧姆电阻最大过负荷电流 | Operating Temperature 工作温度范围 |
|---------|----------------------------|------------------------------|--------------------------------------|------------------------------------|-----------------------------------|--|------------------------------|
| HQ02 | 50V | 100V | 100V | < 50mΩ | 1A | 2A | -55~+155°C |
| HQ03 | 75V | 100V | 300V | | 1A | 2A | |
| HQ05 | 150V | 300V | 500V | | 2A | 5A | |
| HQ06 | 200V | 400V | 500V | | 2A | 10A | |
| HQ07 | 200V | 500V | 500V | | 2A | 10A | |
| HQ10 | 200V | 500V | 500V | | 2A | 10A | |
| HQ12 | 200V | 500V | 500V | | 2A | 10A | |

| Type 类型 | Size 尺寸 | Power 功率 (125°C) | L (mm) | W (mm) | H (mm) | A (mm) | B (mm) | Resistance Range 阻值范围 1%(E96), 5%(E24) |
|---------|-------------|------------------|-----------|--|-----------|-----------|-----------|--|
| HQ02 | 0402 (1005) | 1/16W | 1.00±0.10 | 0.50±0.05 | 0.35±0.05 | 0.20±0.10 | 0.25±0.10 | 1Ω~10M |
| HQ03 | 0603 (1608) | 1/10W | 1.60±0.10 | 0.80±0.10 | 0.45±0.10 | 0.30±0.20 | 0.30±0.20 | |
| HQ05 | 0805 (2012) | 1/8W | 2.00±0.15 | 1.25 ^{+0.15} _{-0.10} | 0.55±0.10 | 0.40±0.20 | 0.40±0.20 | |
| HQ06 | 1206 (3216) | 1/4W | 3.10±0.15 | 1.55 ^{+0.15} _{-0.10} | 0.55±0.10 | 0.45±0.20 | 0.45±0.20 | |
| HQ07 | 1210 (3225) | 1/3W | 3.10±0.10 | 2.60±0.20 | 0.55±0.10 | 0.50±0.25 | 0.50±0.20 | |
| HQ10 | 2010 (5025) | 3/4W | 5.00±0.10 | 2.50±0.20 | 0.55±0.10 | 0.60±0.25 | 0.50±0.20 | |
| HQ12 | 2512 (6432) | 1W | 6.35±0.10 | 3.20±0.20 | 0.55±0.10 | 0.60±0.25 | 0.50±0.20 | |

*Special offers 特别提供: HQ12 B:1.80±0.25mm

Performance Specification (性能)

| Test Item 试验项目 | Test Methods 试验方法 | Evaluation Criteria 判定标准 |
|---|---|--|
| Temperature coefficient 温度系数 | Measure between: -55°C ~+125°C 测定范围: -55°C ~+125°C | 1Ω≤R≤10 Ω: ±400ppm/°C 10Ω<R≤100 Ω: ±200ppm/°C 100Ω<R≤10MΩ: ±100ppm/°C |
| Short-time overload 短时间过负荷 | 2.5x Rated voltage or Max. Overload Voltage whichever is lower for 5 seconds, then check the resistance. 2.5 倍额定电压或最大过负荷电压 (取其低者), 持续 5 秒钟, 然后测阻值。 | ±1%±(1.0%+0.1Ω)Max (最大) ±5%±(2.0%+0.1Ω)Max (最大) |
| Terminal Bending 端子弯曲 | Bending Distance 3mm, Duration: 60s±5s, then check the resistance. 弯曲距离: 3mm, 保持时间: 60s±5s, 然后测试阻值。 | ±(1.0%+0.05Ω)Max(最大) |
| Solderability 可焊性 | 245±3°C; 2~3s 245±3°C; 2~3 秒 | 95% coverage Min 覆盖率 ≥95% |
| Soldering heat 耐焊接热 | 260±5°C; 10±1s 260±5°C; 10±1 秒 | ±(1.0%+0.05Ω) Max (最大) |
| Moisture Resistance 耐湿性 | 25°C~65°C, 90~100%RH, 2.5Hr; 65°C 90~100%RH, 3Hr; 65°C~25°C 80~100%RH, 2.5Hr, 10 cycles, Measurement at 24 hours after test conclusion 25°C~65°C, 90~100%RH, 2.5 小时; 65°C 90~100%RH, 3 小时; 65°C~25°C, 80~100%RH, 2.5 小时, 10 个循环, 试验结束 24 小时后进行测试。 MIL-STD-202 Method 106 | ±1%: ±(1.0%+0.1Ω)Max (最大) ±5%: ±(3.0%+0.1Ω) Max (最大) |
| Biased Humidity 偏置湿度 | 10% rated power, 85°C/85%RH, 1000Hr, Measurement at 24 hours after test conclusion 10% 额定功率, 85°C/85%RH, 持续通电 1000 小时, 试验结束 24 小时后进行测试。 MIL-STD-202 Method 103 | ±1%: ±(1.0%+0.1Ω)Max (最大) ±5%: ±(3.0%+0.1Ω) Max (最大) |
| Dielectric withstanding voltage 绝缘耐压 | Resistor shall be clamped in the trough of 90° metallic V-block and shall be tested at AC potential respectively specified in the given list of each product type for 60~70s. 电阻固定在 90° 的 V 型槽中, 根据不同产品规定交流电压, 持续 60~70 秒。 | No evidence of flashover, mechanical damage, arcing or insulation breakdown 无击穿, 飞弧及可见机械性损伤 |
| Temperature cycling 温度循环 | -55±3°C 30min ~normal temperature 10min-15min~155±2°C 30min~normal temperature 10min-15min, 1000 cycles, Measurement at 24 hours after test conclusion. -55±3°C(30 分钟)~ 室温(10-15 分钟)~155±2°C(30 分钟)~ 室温(10~15 分钟) 1000 个循环, 试验结束 24 小时后进行测试。 JESD22 Method JA-104 | ±(1.0%+0.1Ω) Max (最大) |
| Load life 负载寿命 | 125°C, at RCWV or Max.Working Voltage whichever less, 1,000 hours(1.5 hours "ON", 0.5 hours "OFF"), Measurement at 24±2 hours after test conclusion. 125°C, 额定工作电压或最大工作电压 (取其低者), 持续时间: 1,000 小时 (1.5 小时 "通", 0.5 小时 "断"), 试验结束 24 小时后进行测试。 MIL-STD-202 Method 108 | ±1%: ±(1.0%+0.1Ω) Max (最大) ±5%: ±(3.0%+0.1Ω) Max (最大) |
| Sulfuration test 硫化测试 | H2S 3~5PPM 50°C±2°C 91%~93% RH 1000H | ±5%±(5.0%+0.1 Ω)Max ±1%±(1.0%+0.1 Ω)Max |

Ordering Procedure (Example: HQ06 1/4W 5% 1.2 Ω T/R-5000)

订购方式 (例如: HQ06 1/4W 5% 1.2 Ω T/R-5000)

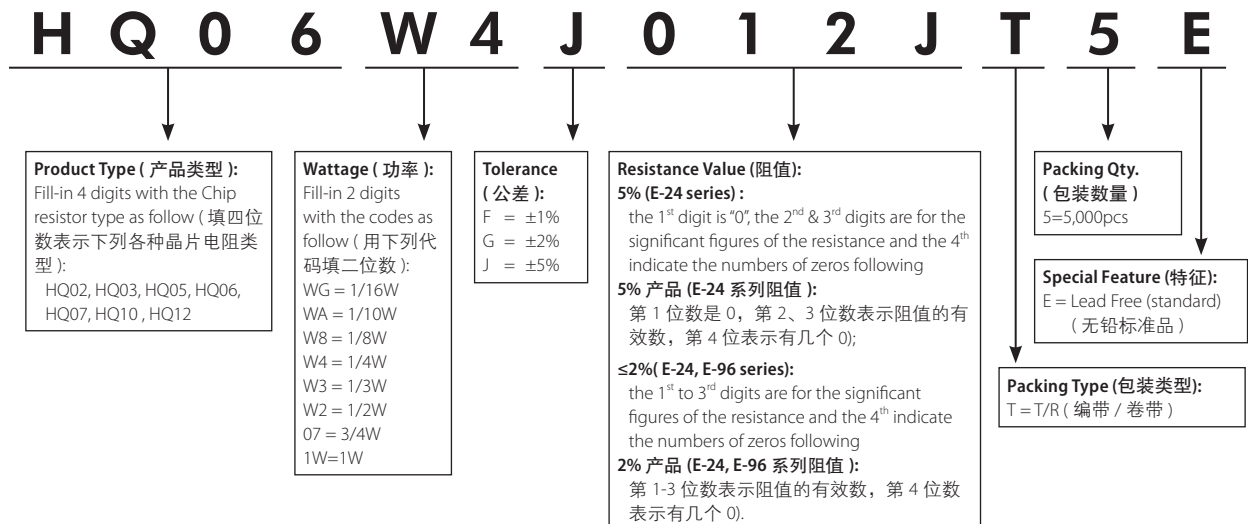

Feature (特性)

- Anti-sulfurized 抗硫化
- AEC-Q200 qualified 符合 AEC-Q200 相关条款
- Suitable for reflow & wave soldering 适合波峰焊和回流焊
- Application car, IPAD, LED lamps, Intelligent home appliances, Medical equipment, Kinds of industrial control devices & Industrial supplies
适用于汽车、IPAD、LED 灯具、智能家电产品、医疗设备、各种工业控制装置及工业电源等



Figures (型状)

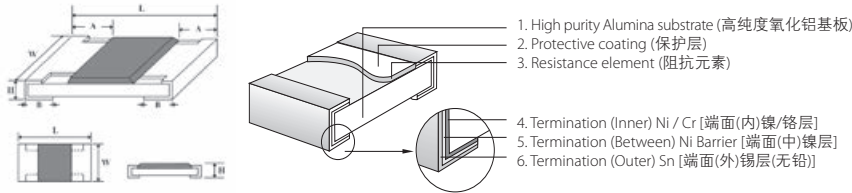

Derating Curve (降功率曲线)

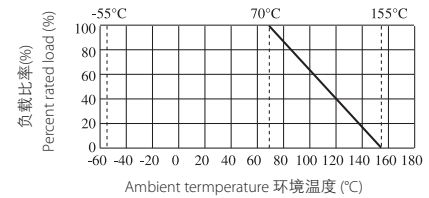

Specification (性能)

| Type 类型 | Size 尺寸 | Max Working Voltage 最大工作电压 | Max Overload Voltage 最大过负荷电压 | Dielectric Withstanding Voltage 绝缘耐压 | Resistance Value of Jumper 零欧姆电阻阻值 | Rated Current of Jumper 零欧姆电阻额定电流 | Max. Overload Current of Jumper 零欧姆电阻最大过负荷电流 | Operating Temperature 工作温度范围 |
|---------|-------------|----------------------------|------------------------------|--------------------------------------|------------------------------------|-----------------------------------|--|------------------------------|
| NQ01 | 0201 (0603) | 25V | 50V | / | <50mΩ | 0.5A | 1A | -55~+155°C |
| NQ02 | 0402 (1005) | 50V | 100V | 100V | <50mΩ | 1A | 2A | |
| NQ03 | 0603 (1608) | 75V | 150V | 300V | <50mΩ | 1A | 2A | |
| NQ05 | 0805 (2012) | 150V | 300V | 500V | <50mΩ | 2A | 5A | |
| NQ06 | 1206 (3216) | 200V | 400V | 500V | <50mΩ | 2A | 10A | |
| NQ07 | 1210 (3225) | 200V | 500V | 500V | <50mΩ | 2A | 10A | |
| NQ10 | 2010 (5025) | 200V | 500V | 500V | <50mΩ | 2A | 10A | |
| NQ12 | 2512 (6432) | 200V | 500V | 500V | <50mΩ | 2A | 10A | |

| Type 类型 | Size 尺寸 | Power 功率 (70°C) | L (mm) | W (mm) | H (mm) | A (mm) | B (mm) | Resistance Range 阻值范围 1%(E96), 5%(E24) |
|---------|-------------|-----------------|-----------|--|-----------|-----------|-----------|---|
| NQ01 | 0201 (0603) | 1/20W | 0.60±0.03 | 0.30±0.03 | 0.23±0.03 | 0.12±0.05 | 0.15±0.05 | 0.5%,1%,2%,5%: 1Ω~10M 0Ω |
| NQ02 | 0402 (1005) | 1/16W | 1.00±0.10 | 0.50±0.05 | 0.35±0.05 | 0.20±0.10 | 0.25±0.10 | |
| NQ03 | 0603 (1608) | 1/10W | 1.60±0.10 | 0.80±0.10 | 0.45±0.10 | 0.30±0.20 | 0.30±0.20 | |
| NQ05 | 0805 (2012) | 1/8W | 2.00±0.15 | 1.25 ^{+0.15} _{-0.10} | 0.55±0.10 | 0.40±0.20 | 0.40±0.20 | |
| NQ06 | 1206 (3216) | 1/4W | 3.10±0.15 | 1.55 ^{+0.15} _{-0.10} | 0.55±0.10 | 0.45±0.20 | 0.45±0.20 | |
| NQ07 | 1210 (3225) | 1/2W | 3.10±0.10 | 2.60±0.20 | 0.55±0.10 | 0.50±0.25 | 0.50±0.20 | |
| NQ10 | 2010 (5025) | 3/4W | 5.00±0.10 | 2.50±0.20 | 0.55±0.10 | 0.60±0.25 | 0.50±0.20 | |
| NQ12 | 2512 (6432) | 1W | 6.35±0.10 | 3.20±0.20 | 0.55±0.10 | 0.60±0.25 | 0.50±0.20 | |

Performance Specification (性能)

| Test Item 试验项目 | Test Methods 试验方法 | Evaluation Criteria 判定标准 |
|---|---|---|
| Temperature coefficient 温度系数 | Measure between: -55°C ~+125°C 测定范围: -55°C ~+125°C | 1Ω≤R≤10 Ω: ±400 ppm/°C 10Ω<R≤100 Ω: ±200 ppm/°C 100Ω<R≤10MΩ: ±100 ppm/°C NQ01:10Ω<R≤10M: ±200 ppm/°C |
| Short-time overload 短时间过负荷 | 2.5x Rated voltage or Max. Overload Voltage whichever is lower for 5 seconds, then check the resistance 2.5 倍额定电压或最大过负荷电压 (取其低者), 持续 5 秒钟, 然后测阻值 | ±1%±(1.0%+0.1Ω)Max (最大) ±5%±(2.0%+0.1Ω)Max (最大) |
| Terminal Bendin 端子弯曲 | Bending Distance 3mm, Duration:60s±5s, then check the resistance. 弯曲距离:3mm, 保持时间:60s±5s, 然后测试阻值 | ±(1.0%+0.05Ω)Max (最大) |
| Solderability 可焊性 | 245±3°C; 2~3 秒 245±3°C; 2~3S | 95% coverage Min 覆盖率 ≥95% |
| Soldering heat 耐焊接热 | 260±5°C; 10±1S 260±5°C; 10±1 秒 | ±(1.0%+0.05Ω) Max (最大) |
| Mouisture Resistance 耐湿性 | 25°C~65°C,90~100%RH, 2.5H, 65°C 90~100%RH, 3H, 65°C~25°C, 80~100%RH, 2.5Hr, 10 cycles, Measurement at 24 hours after test conclusion 25°C~65°C,90~100%RH, 2.5 小时; 65°C 90~100%RH, 3 小时; 65°C~25°C,80~100%RH, 2.5 小时,10 个循环, 试验结束 24 小时后进行测试 MIL-STD-202 Method 106 | ±1%: ±(1.0%+0.1Ω)Max (最大) ±5%: ±(3.0%+0.1Ω) Max (最大) |
| Biased Humidity 偏置湿度 | 10% rated power, 85°C/85%RH, 1000Hr, Measurement at 24 hours after test conclusion 10% 额定功率, 85°C/85%RH, 持续通电 1000 小时, 试验结束 24 小时后进行测试. MIL-STD-202 Method 103 | ±1%: ±(1.0%+0.1Ω)Max (最大) ±5%: ±(3.0%+0.1Ω) Max (最大) |
| Dielectric withstanding voltage 绝缘耐压 | Resistor shall be clamped in the trough of 90°C metallic V-block and shall be tested at AC potential respectively specified in the given list of each product type for 60~70s. 电阻固定在 90°C 的 V 型槽中, 根据不同产品规定交流电压, 持续 60~70 秒. | No evidence of flashover, mechanical damage, arcing or insulation breakdown 无击穿, 飞弧及可见机械性损伤 |
| Temperature cycling 温度循环 | -55±3°C 30min ~normal temperature 10min-15min~155±2°C 30min~normal temperature 10min-15min, 1000 cycles, Measurement at 24 hours after test conclusion. -55±3°C(30 分钟)~室温(10-15 分钟)~155±2°C(30 分钟)~室温(10~15 分钟) 1000 个循环, 试验结束 24 小时后进行测试 JESD22 Method JA-104 | ±(1.0%+0.1Ω) Max (最大) |
| Load life 负载寿命 | 1,000 hours at 125 °C, derated voltage applied for 1.5 hours on, 0.5 hour off, Measurement at 24±2hours after test conclusion. 在 125°C 下, 施加降额电压, 1.5 小时“通”, 0.5 小时“断”, 试验结束 24 小时后进行测试 MIL-STD-202 Method 108 | ±1%: ±(1.0%+0.1Ω) Max (最大) ±5%: ±(3.0%+0.1Ω) Max (最大) |
| Sulfuration test 硫化测试 | Soaked in industrial oil with sulfur substance 3.5% contained 105°C ±3°C 500h 工业用油含硫磺成份 3.5%, 105°C±3, 500H | ΔR≤±(5%+0.1Ω) |

Ordering Procedure (Example: NQ06 1/4W 5% 1.2 Ω T/R-5000)

订购方式 (例如: NQ06 1/4W 5% 1.2 Ω T/R-5000)

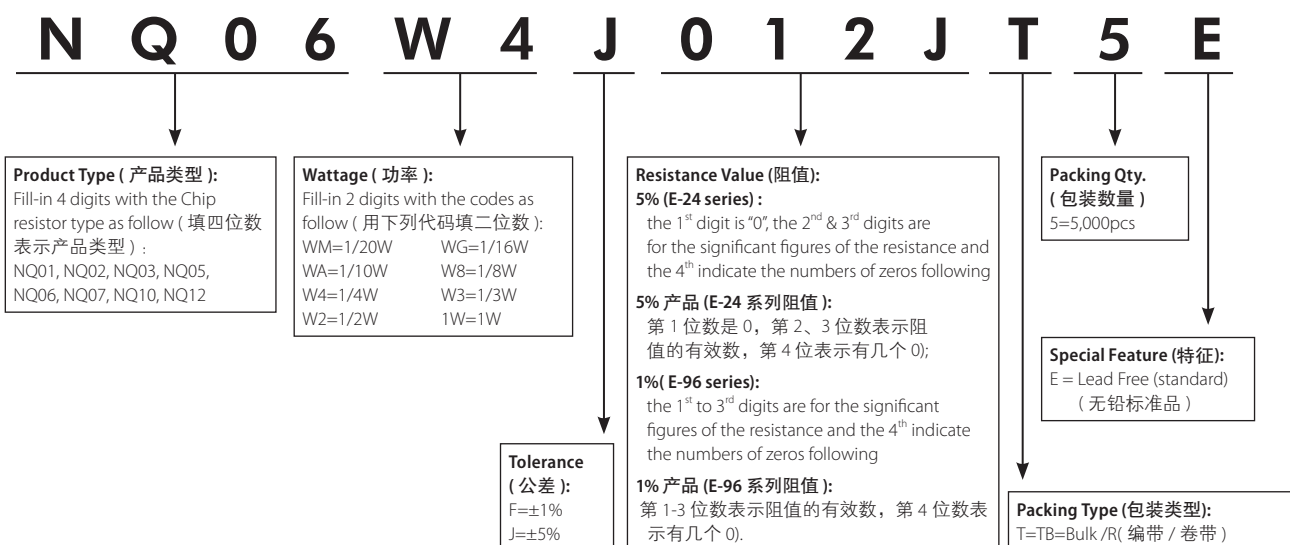

Feature (特性)

- Anti-Sulfidation 抗硫化
- Suitable for reflow & wave soldering 适合波峰焊与回流焊
- Application car, power 适用于汽车、电源等



Derating Curve (降功率曲线)

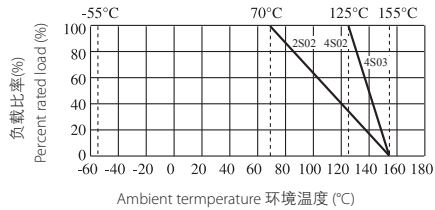

Dimension (mm) & Conformation [尺寸(mm)与结构]

| Type 类型 | 2S02 | 4S02 | 4S03 |
|----------------------------------|--------------|--------------------|--------------------|
| Size 尺寸 | 0402×2 | 0402×4 | 0603×4 |
| Dimension 规格 (mm) | | | |
| Equivalent Circuit Diagram 等效电路图 | <p>R1=R2</p> | <p>R1=R2=R3=R4</p> | <p>R1=R2=R3=R4</p> |

Characteristics (特性)

| Type 类型 | Power Rating 功率 | Max. Working Voltage 最大工作电压 | Max. Overload Voltage 最大过负荷电压 | Resistance Range 阻值范围 | Dielectric Withstanding Voltage 绝缘耐压 | Tolerance 公差 | Operating Temperature 工作温度范围 | Resistance Value of Jumper 零欧姆电阻阻值 | Rated Current of Jumper 零欧姆电阻额定电流 | T.C.R 温度系数 (PPM/°C) |
|---------|-----------------|-----------------------------|-------------------------------|-----------------------|--------------------------------------|--------------|------------------------------|------------------------------------|-----------------------------------|------------------------|
| 2S02 | 1/16W | 50V | 100V | 10Ω~1MΩ | 100 | ±1%, ±5% | -55°C~+155°C | <50mΩ | 1A | ±200 |
| 4S02 | | | | 10Ω~1MΩ | 100 | | | | | ±200 |
| 4S03 | | | | 1Ω~1MΩ | 300 | | | | | ≥10Ω:±200 <10Ω:±400 |

Performance Specification (性能)

| Test Item 试验项目 | Test Methods 试验方法 | Evaluation Criteria 判定标准 |
|---|--|--|
| Short-time overload 短时间过负荷 | 2.5x Rated voltage or Max. Overload Voltage whichever is lower for 5 seconds, then check the resistance. 2.5 倍额定电压或最大过负荷电压 (取其低者), 持续 5 秒钟, 然后测阻值。 | $\pm(2.0\%+0.1\Omega)$ Max (最大) |
| Terminal Bending 端子弯曲 | Bending Distance 3mm, Duration: 60s \pm 5s, then check the resistance. 弯曲距离: 3mm, 保持时间: 60s \pm 5s, 然后测试阻值。 | $\pm(1.0\%+0.05\Omega)$ Max (最大) |
| Solderability 可焊性 | 245 \pm 3 $^{\circ}$ C; 2~3s 245 \pm 3 $^{\circ}$ C; 2~3 秒 | 95% coverage Min 覆盖率 \geq 95% |
| Soldering heat 耐焊接热 | 260 \pm 5 $^{\circ}$ C; 10 \pm 1s 260 \pm 5 $^{\circ}$ C; 10 \pm 1 秒 | $\pm(1.0\%+0.05\Omega)$ Max (最大) |
| Moisture Resistance 耐湿性 | 25 $^{\circ}$ C~65 $^{\circ}$ C, 90~100%RH, 2.5Hr; 65 $^{\circ}$ C 90~100%RH, 3Hr; 65 $^{\circ}$ C~25 $^{\circ}$ C 80~100%RH, 2.5Hr, 10 cycles, Measurement at 24 hours after test conclusion 25 $^{\circ}$ C~65 $^{\circ}$ C, 90~100%RH, 2.5 小时; 65 $^{\circ}$ C 90~100%RH, 3 小时; 65 $^{\circ}$ C~25 $^{\circ}$ C, 80~100%RH, 2.5 小时, 10 个循环, 试验结束 24 小时后进行测试。 MIL-STD-202 Method 106 | $\pm(3.0\%+0.1\Omega)$ Max (最大) |
| Biased Humidity 偏置湿度 | 10% rated power, 85 $^{\circ}$ C/85%RH, 1000Hr, Measurement at 24 hours after test conclusion 10% 额定功率, 85 $^{\circ}$ C/85%RH, 持续通电 1000 小时, 试验结束 24 小时后进行测试。 MIL-STD-202 Method 103 | $\pm(3.0\%+0.1\Omega)$ Max (最大) |
| Dielectric withstanding voltage 绝缘耐压 | Resistor shall be clamped in the trough of 90 $^{\circ}$ C metallic V-block and shall be tested at AC potential respectively specified in the given list of each product type for 60~70s. 电阻固定在 90 $^{\circ}$ C 的 V 型槽中, 根据不同产品规定交流电压, 持续 60~70 秒。 | No evidence of flashover, mechanical damage, arcing or insulation breakdown 无击穿, 飞弧及可见机械性损伤 |
| Temperature cycling 温度循环 | -55 \pm 3 $^{\circ}$ C 30min ~normal temperature 10min-15min~155 \pm 2 $^{\circ}$ C 30min~normal temperature 10min-15min 1000 cycles, Measurement at 24 hours after test conclusion. -55 \pm 3 $^{\circ}$ C(30 分钟)~ 室温 (10-15 分钟)~155 \pm 2 $^{\circ}$ C(30 分钟)~ 室温 (10~15 分钟) 1000 个循环, 试验结束 24 小时后进行测试。 JESD22 Method JA-104 | $\pm(1.0\%+0.1\Omega)$ Max (最大) |
| Load life 负载寿命 | 2S02, 4S02: 125 $^{\circ}$ C, 35% power, 4S03: 125 $^{\circ}$ C, 100% power, at RCWV or Max.Working Voltage whichever less, 1,000 hours(1.5 hours "ON", 0.5hours "OFF"), Measurement at 24 \pm 2 hours after test conclusion. 2S02, 4S02: 125 $^{\circ}$ C, 35% 功率, 4S03: 125 $^{\circ}$ C, 100% 功率, 额定工作电压或最大工作电压 (取其低者), 持续时间: 1,000 小时 (1.5 小时 "通", 0.5 小时 "断"), 试验结束 24 小时后进行测试。 MIL-STD-202 Method 108 | $\pm(3.0\%+0.1\Omega)$ Max (最大) |
| Sulfuration test 硫化测试 | Soaked in industrial oil with sulfur substance 3.5% contained 105 $^{\circ}$ C \pm 3 $^{\circ}$ C 500h 工业用油含硫成份 3.5%, 105 $^{\circ}$ C \pm 3, 500H | $\Delta R \leq \pm(5\%+0.1\Omega)$ |

Ordering Procedure (Example: 2S02 1/16W \pm 5%1.2K T/R-10000)

订购方式 (例如: 2S02 1/16W \pm 5%1.2K T/R-10000)

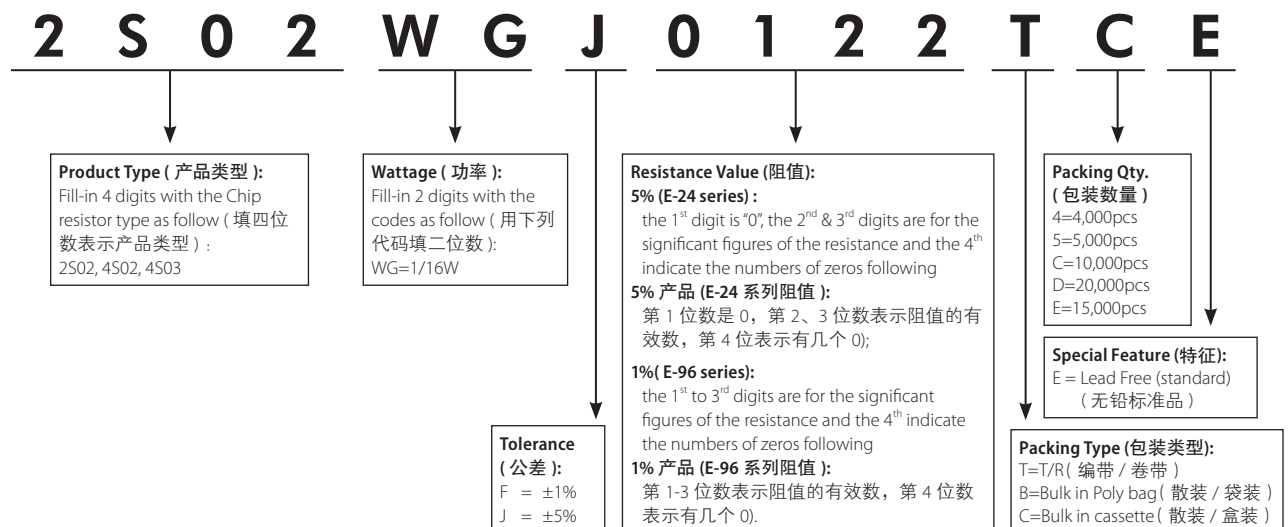

Feature (特性)

- High density, more than 1 resistors in one small case 高度密集, 多个电阻在一个表贴封装中
- Improvement of placement efficiency 装配效率高
- Tape/Reel packaging is suitable for automatic placement machine 编带卷装适合自动化机器
- Superior solderability 优越焊锡性
- Application: Master board, CD & DVD Rom, Hard Disk, RAM
应用于 CD、DVD、硬盘、内存、主板等



Equivalent Circuit Diagram (等效电路图)

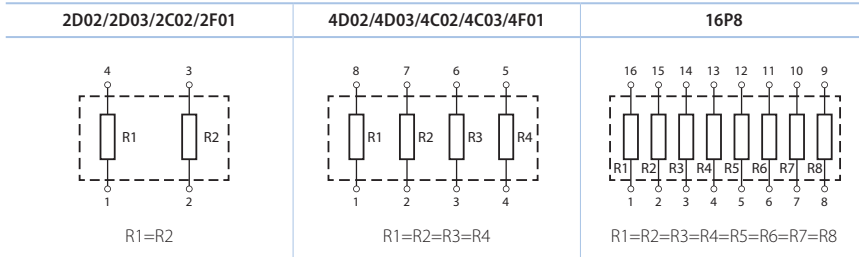

Derating Curve (降功率曲线)

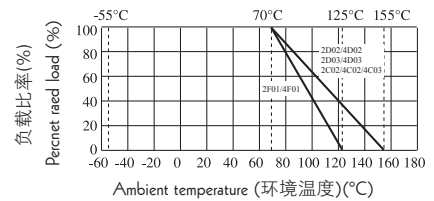

Dimensions in mm (外观尺寸)

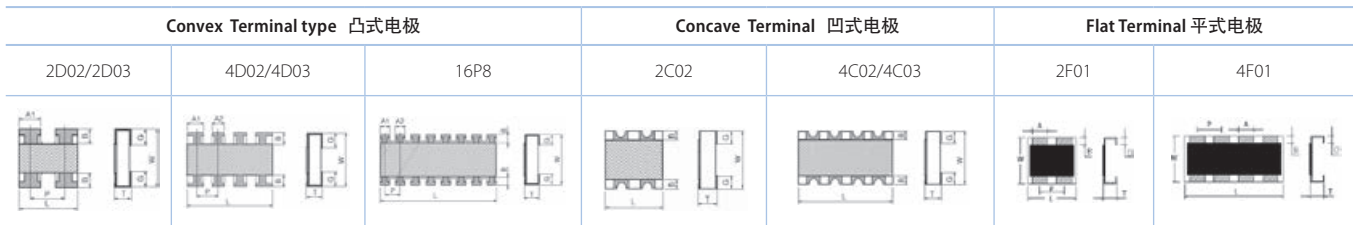

| Type 类型 | Dimensions 尺寸 (mm) | | | | | | | |
|-------------|--------------------|-----------|-----------|-----------|-----------|-----------|-----------|-----------|
| | L | W | T | A1 | A2 | B | P | G |
| 2D02 0402*2 | 1.0±0.10 | 1.0±0.10 | 0.35±0.10 | 0.33±0.10 | / | 0.15±0.05 | 0.65±0.05 | 0.25±0.1 |
| 4D02 0402*4 | 2.0±0.10 | 1.0±0.10 | 0.45±0.10 | 0.40±0.05 | 0.30±0.05 | 0.20±0.15 | 0.50±0.05 | 0.30±0.15 |
| 2D03 0603*2 | 1.60±0.15 | 1.60±0.15 | 0.50±0.10 | 0.60±0.15 | / | 0.30±0.10 | 0.80±0.05 | 0.25±0.10 |
| 4D03 0603*4 | 3.20±0.20 | 1.60±0.20 | 0.50±0.10 | 0.65±0.15 | 0.50±0.15 | 0.30±0.15 | 0.80±0.10 | 0.30±0.15 |
| 16P8 | 4.0±0.20 | 1.60±0.15 | 0.45±0.10 | 0.45±0.05 | 0.30±0.05 | 0.30±0.15 | 0.50±0.05 | 0.40±0.15 |
| 2C02 0402*2 | 1.0±0.10 | 1.0±0.10 | 0.35±0.10 | / | / | 0.15±0.10 | / | 0.30±0.10 |
| 4C02 0402*4 | 2.0±0.10 | 1.0±0.10 | 0.45±0.10 | / | / | 0.15±0.10 | / | 0.30±0.10 |
| 4C03 0603*4 | 3.20±0.20 | 1.60±0.20 | 0.60±0.10 | / | / | 0.30±0.20 | / | 0.4±0.10 |
| 2F01 0201*2 | 0.8±0.1 | 0.6±0.1 | 0.35±0.1 | 0.3±0.1 | / | 0.15±0.1 | 0.5±0.05 | 0.15±0.1 |
| 4F01 0201*4 | 1.4±0.1 | 0.6±0.1 | 0.35±0.1 | 0.2±0.1 | / | 0.15±0.1 | 0.4±0.05 | 0.15±0.1 |

Ratings (规格)

| Type 类型 | Rated power (功率) 70°C | Max Working Voltage 最大工作电压 | Max Overload Voltage 最大过负荷电压 | Dielectric Withstanding Voltage 绝缘耐压 | Resistance Range 阻值范围 ±5%, ±1% | Temperature Coefficient 温度系数 PPM/°C | Operating Temperature 工作温度范围 | Resistance Value of Jumper 零欧姆电阻阻值 | Rated Current of Jumper 零欧姆电阻额定电流 |
|------------|-----------------------------|-------------------------------|---------------------------------|---|--------------------------------------|---|---------------------------------|---------------------------------------|--------------------------------------|
| 2D02 | 1/16W | 50V | 100V | 100V | 10Ω~1MΩ | ±200 | | | |
| 4D02 | 1/16W | 50V | 100V | 100V | 10Ω~1MΩ | ±200 | | | |
| 2D03 | 1/16W | 50V | 100V | 100V | 10Ω~1MΩ | ±200 | | | |
| 4D03 | 1/16W | 50V | 100V | 300V | 1Ω~1MΩ | ≥10Ω:±200 <10Ω:±400 | | | |
| 4DP3 | 1/10W | 50V | 100V | 300V | 1Ω~1MΩ | ≥10Ω:±200 <10Ω:±400 | -55°C~+155°C | <50mΩ | 1A |
| 16P8 | 1/16W | 50V | 100V | 300V | 1Ω~1MΩ | ≥10Ω:±200 <10Ω:±400 | | | |
| 2C02 | 1/16W | 50V | 100V | 100V | 10Ω~1MΩ | ±200 | | | |
| 4C02 | 1/16W | 50V | 100V | 100V | 10Ω~1MΩ | ±200 | | | |
| 4C03 | 1/16W | 50V | 100V | 300V | 1Ω~1MΩ | ≥10Ω:±200 <10Ω:±400 | | | |
| 2F01 | 1/20W | 12.5V | 25V | / | 10Ω~1MΩ | ±200 | -55°C ~+125°C | <50mΩ | 1A |
| 4F01 | 1/20W | 12.5V | 25V | / | 10Ω~1MΩ | ±200 | | | |

Performance Specification (性能)

| | | |
|---------------------------------|--------|---|
| Short-time overload | 短时间过负荷 | ± (2.0%±0.1Ω) Max.(最大) 2F01: 1%:±1%+0.05Ω,5%:±2%+0.05Ω |
| Insulation Resistance | 绝缘电阻 | ≥1000MΩ |
| Dielectric withstanding voltage | 绝缘耐压 | No evidence of flashover mechanical damage, arcing or insulation break down. 无击穿, 飞弧及可见机械性损伤 |
| Terminal bending | 端子弯曲 | ± (1.0%±0.05Ω) Max.(最大) |
| Soldering heat | 耐焊接热 | ΔR/R ≤ ± (1.0%+0.05Ω) |
| Solderability | 可焊性 | Min.95% coverage (最少 95% 覆盖) |
| Temperature cycling | 温度循环 | ΔR/R ≤ ± (1.0%+0.05Ω) 2F01: 1%:±0.5%+0.05Ω,5%:±1%+0.05Ω |
| Load life in humidity | 湿度寿命 | ±(3.0%±0.1Ω)Max. 最大 2F01: 1%:±2%+0.1Ω,5%: 3.0%±0.1Ω |
| Load life | 负载寿命 | ±(3.0%±0.1Ω)Max. 最大 2F01: 1%:±2%+0.1Ω,5%: 3.0%±0.1Ω |

Ordering Procedure (Example: 2F01 1/20W ±5% 10K T/R-10000)

订购方式 (例如: 2F01 1/20W ±5% 10K T/R-10000)

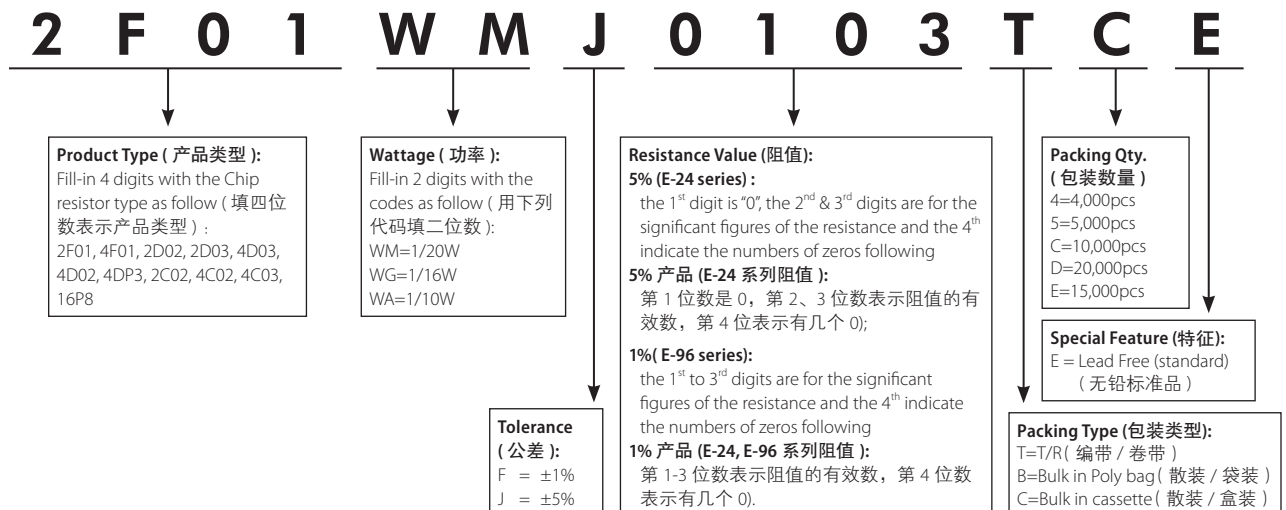

Feature (特性)

- High density, more than 1 resistors in one small case 高度密集, 多个电阻在一个表贴封装中
- Improvement of placement efficiency 装配效率高
- Tape/Reel packaging is suitable for automatic placement machine 编带卷装适合自动化机器
- Superior solderability 优越焊锡性

Dimension (尺寸) (mm)

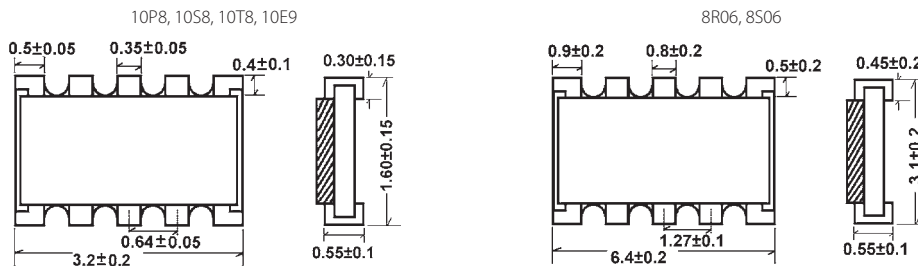

Equivalent Circuit Diagram (等效电路图)

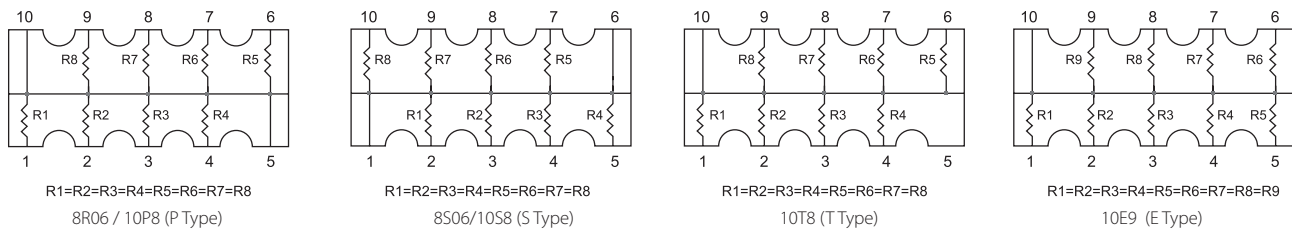

Characteristics (特性)

| | | 10P8,10S8,10T8,10E9 | 8R06, 8S06 |
|---------------------------------|-----------|---------------------------------------|------------------------------|
| Rated Power at 70°C | 功率 | 1/32W [1/16W special provide (可特别提供)] | 1/16W |
| Max. Working Voltage | 最大工作电压 | 25V | 50V |
| Max. Overload Voltage | 最大过负荷电压 | 50V | 100V |
| Dielectric withstanding Voltage | 绝缘耐压 | 50V | 100V |
| Operating temperature | 工作温度 | -55°C ~ +155 °C | 55°C ~ +155 °C |
| Resistance Range | 阻值范围 | 10Ω~1MΩ | ±1% :30Ω~1MΩ ±5% :10Ω~1MΩ |
| Resistance Value of Jumper | 零欧姆电阻阻值 | <50mΩ | / |
| Rated Current of Jumper | 零欧姆电阻额定电流 | 0.5A | / |

Performance Specification (性能)

| Temperature Coefficient | 温度系数 | ±200PPM/°C |
|---------------------------------|--------|--|
| Short-time overload | 短时间过负荷 | ±(2.0% ±0.05Ω) Max.(最大) |
| Insulation resistance | 绝缘电阻 | ≥1,000MΩ |
| Dielectric withstanding voltage | 绝缘耐压 | No evidence of flashover, mechanical damage, arcing or insulation breakdown 无击穿, 飞弧及可见机械性损伤 |
| Terminal bending | 端子弯曲 | ±(1.0% ±0.05Ω) Max.(最大) |
| Soldering heat | 耐焊接热 | ΔR/R ≤ ±(1.0% ±0.05Ω) |
| Solderability | 可焊性 | Min.95% coverage (最少 95% 覆盖率) |
| Load life in humidity | 湿度寿命 | ±(3.0% ±0.1Ω) Max.(最大) |
| Load life | 负载寿命 | ±(3.0% ±0.1Ω) Max.(最大) |

- Please refer to page 12 for the information of Ordering Procedure (Part No.)
订购方式, 请参考第 12 页 (料号)

Dimension of Paper Taping (纸带尺寸)(mm)

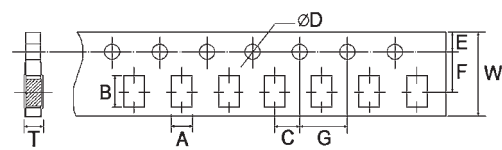
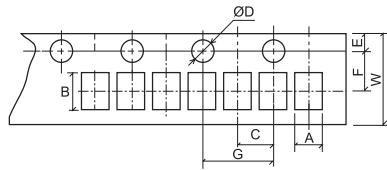

01005 0201 2F01 4F01 PF0A NS01 0402 HP02 HQ02 NM02 TC02 PF02
PS02 CS02 NS02 2C02 4C02 4D02 2D02 2S02 4S02

0603 0805 1206 1210 2010 0508 0612 1020 HQ03 HQ05 HQ06 HQ07 HQ10 HP03 HP05 HP06 HP07 HP10 HV03 HV05 HV06
HV07 HV10 NM03 NM05 NM06 NS03 NS05 NS06 NS07 NS10 AS03 AS05 AS06 AS07 AS10PS03 PS05 PS06 PS07 PS10 CS03
CS05 CS06 CS07 CS10 TC03 TC05 TC06 TC07 TC10 TR05 TR06 2F014F01 2D03 4D03 4C03 10P8 10S8 10T8 10E9 16P8

| Type (类型) | A±0.2 | B±0.2 | C±0.05 | ØD ^{+0.1} ₋₀ | E±0.1 | F±0.05 | G±0.1 | W±0.2 | T±0.1 |
|--|-----------|-----------|--------|----------------------------------|-------|--------|-------|-------|-------|
| 01005, PF0A | 0.24±0.05 | 0.45±0.05 | 2.0 | 1.5 | 1.75 | 3.5 | 4.0 | 8.0 | 0.40 |
| 0201, ES01, PF01, NS01 | 0.40±0.05 | 0.70±0.05 | 2.0 | 1.5 | 1.75 | 3.5 | 4.0 | 8.0 | 0.42 |
| 0402, CS02, CQ02, ES02, HP02, HQ02, PF02, LT02, NM02, TC02, PS02 | 0.65 | 1.15 | 2.0 | 1.5 | 1.75 | 3.5 | 4.0 | 8.0 | 0.45 |
| 0603, AS03, PS03, CQ03, ES03, HP03, HQ03, HV03, PF03, LT03, NM03, NS03, TC03, TR03 | 1.10 | 1.90 | 2.0 | 1.5 | 1.75 | 3.5 | 4.0 | 8.0 | 0.67 |
| WR08, 0805, AS05, CQ05, CS05, ES05, HP05, HV05, HQ05, LE05, PF05, LT05, MS05, NM05, NS05, PS05, TC05, TR05 | 1.65 | 2.40 | 2.0 | 1.5 | 1.75 | 3.5 | 4.0 | 8.0 | 0.81 |
| WR12, 1206, AS06, CQ06, CS06, ES06, HP06, HQ06, HV06, PF06, LE06, LT06, MS06, NS06, NM06, PS06, TC06, TR06 | 2.00 | 3.60 | 2.0 | 1.5 | 1.75 | 3.5 | 4.0 | 8.0 | 0.81 |
| 1210, CQ07, HQ07, HP07, CS07, ES07, HV07, PF07, MS07, PS07, AS07, TC07, NS07 | 2.80 | 3.50 | 2.0 | 1.5 | 1.75 | 3.5 | 4.0 | 8.0 | 0.75 |
| 2010, AS10, CQ10, HQ10, HP10, CS10, HV10, NS10, MS10, PS10, WR20, PF10 | 2.80 | 5.40 | 2.0 | 1.5 | 1.75 | 5.5 | 4.0 | 12.0 | 0.75 |
| 2D02, 2C02, 2S02 | 1.20 | 1.20 | 2.0 | 1.5 | 1.75 | 3.5 | 4.0 | 8.0 | 0.45 |
| 4D02, 4C02, 4S02 | 1.20 | 2.20 | 2.0 | 1.5 | 1.75 | 3.5 | 4.0 | 8.0 | 0.70 |
| 2F01 | 0.79 | 1.0 | 2.0 | 1.5 | 1.75 | 3.5 | 4.0 | 8.0 | 0.5 |
| 4F01 | 0.9 | 1.7 | 2.0 | 1.5 | 1.75 | 3.5 | 4.0 | 8.0 | 0.5 |
| 2D03 | 1.90 | 1.90 | 2.0 | 1.5 | 1.75 | 3.5 | 4.0 | 8.0 | 0.83 |
| 4D03, 4C03, 4S03 | 2.00 | 3.60 | 2.0 | 1.5 | 1.75 | 3.5 | 4.0 | 8.0 | 0.83 |
| 10P8, 10S8, 10T8, 10E9 | 2.00 | 3.60 | 2.0 | 1.5 | 1.75 | 3.5 | 4.0 | 8.0 | 0.85 |
| 16P8 | 1.80 | 4.30 | 2.0 | 1.5 | 1.75 | 5.5 | 4.0 | 12.0 | 0.75 |
| MS17 | 4.5 | 7.4 | 2.0 | 1.5 | 1.75 | 7.5 | 4.0 | 16.0 | 1.1 |
| MS20 | 5.4 | 11.5 | 2.0 | 1.5 | 1.75 | 11.5 | 4.0 | 24.0 | 1.2 |
| MS27 | 7.2 | 11.9 | 2.0 | 1.5 | 1.75 | 11.5 | 4.0 | 24.0 | 1.1 |

Dimension of Embossed Taping (塑胶带尺寸)(mm)

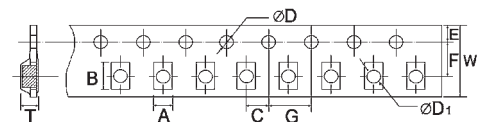

| Type (类型) | A±0.2 | B±0.2 | C±0.05 | ØD ^{+0.1} ₋₀ | ØD ₁ ^{+0.25} ₋₀ | E±0.1 | F±0.05 | G±0.1 | W±0.2 | T±0.1 |
|--|-------|-------|--------|----------------------------------|--|-------|--------|-------|-------|-------|
| TC10 | 2.9 | 5.6 | 2.0 | 1.5 | 1.5 | 1.75 | 5.5 | 4.0 | 12 | 1.0 |
| WR18, 1812, CS11, HP11, MS11 | 3.5 | 4.8 | 2.0 | 1.5 | 1.5 | 1.75 | 5.5 | 4.0 | 12 | 1.0 |
| WR25, 2512, AS12, CS12, CQ12, HP12, HQ12, HV12, PF11, PF12, MS12, NM12, PS12, TC12 | 3.5 | 6.7 | 2.0 | 1.5 | 1.5 | 1.75 | 5.5 | 4.0 | 12 | 1.0 |
| 8R06, 8S06 | 3.4 | 6.6 | 2.0 | 1.5 | 1.5 | 1.75 | 5.5 | 4.0 | 12 | 1.0 |

Dimension of Reel (卷轴尺寸)(mm)

| Type (类型) | Tape 编带 | Qty. / Reel 数量 / 卷装 | Tape Width 纸带宽 | W±1 |
|--|--------------|------------------------|-------------------|------|
| 01005, PF0A | Paper 纸带 | 20,000pcs | 8mm | 10 |
| 0201, 0402, CS02, CQ02, ES01, ES02, HP02, HQ02, LF01, PF02, LT02, NM02, TC02, PS02, NS02 | Paper 纸带 | 10,000pcs | 8mm | 10 |
| 0603, AS03, CQ03, CS03, ES03, HP03, HQ03, HV03, PF03, LT03, NM03, NS03, PS03, TC03 | Paper 纸带 | 5,000pcs | 8mm | 10 |
| WR08, 0805, AS05, CQ05, CS05, ES05, HP05, HQ05, HV05, LE05, PF05, LT05, MS05, NM05, NS05, PS05, TC05, TR05 | Paper 纸带 | 5,000pcs | 8mm | 10 |
| WR12, 1206, AS06, CQ06, CS06, ES06, HP06, HQ06, HV06, PF06, LT06, MS06, NS06, NM06, PS06, TC06, TR06 | Paper 纸带 | 5,000pcs | 8mm | 10 |
| 1210, CS07, CQ07, ES07, HP07, HQ07, HV07, PF07, MS07, PS07, AS07, TC07 | Paper 纸带 | 5,000pcs | 8mm | 10 |
| WR20, 2010, AS10, CQ10, CS10, HP10, HQ10, HV10, PF10, MS10, PS10 | Paper 纸带 | 4,000pcs | 12mm | 13.8 |
| WR18, 1812, CS11, HP11, MS11, TC10, PF11 | Embossed 塑胶带 | 4,000pcs | 12mm | 13.8 |
| WR25, 2512, AS12, CQ12, CS12, HP12, HQ12, HV12, PF12, MS12, NM12, PS12, TC12 | Embossed 塑胶带 | 4,000pcs | 12mm | 13.8 |
| 2D02, 2C02, 2S02 | Paper 纸带 | 10,000pcs | 8mm | 10 |
| 4D02, 4C02, 4S02 | Paper 纸带 | 10,000pcs | 8mm | 10 |
| 2D03, 4D03, 4C03, 4S03 | Paper 纸带 | 5,000pcs | 8mm | 10 |
| 10P8, 10S8, 10T8, 10E9 | Paper 纸带 | 5,000pcs | 8mm | 10 |
| 16P8 | Paper 纸带 | 4,000pcs | 12mm | 13.8 |
| MS17 | Embossed 塑胶带 | 1,000pcs | 16mm | 17 |
| MS20, MS27 | Embossed 塑胶带 | 1,000pcs | 24mm | 25.4 |
| 8R06, 8S06 | Embossed 塑胶带 | 4,000[pcs | 12mm | 13.8 |

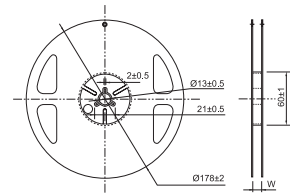

*Remark: 15,000 pcs/reel package could be offered for 0402 size. (备注 : 0402 可提供 15,000 只包装)

Dimension of Bulk Cassette (散装箱尺寸) (mm)

36(H)×12(W)×110(L)

Bulk Cassette packing available on a case to case basis (散装箱可特别提供)



Feature (特性)

- High quality performance 高品质
- Great economy 低成本
- Flame Retardant available 可提供不燃性涂装
- Automatically insertable 适用自动化插件



Dimension(尺寸) mm

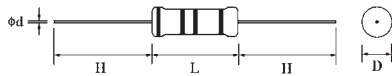

Derating Curve (降功率曲线)

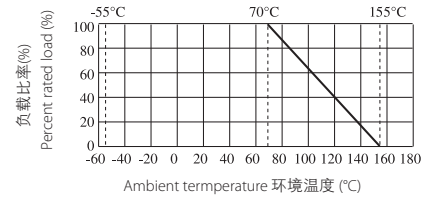

Specification(性能)

| 料号 | 类型 | Power Rating 功率 70 °C | Dimension (尺寸)(mm) | | | | | MAX. Working Voltage 最大工作 电压 | MAX. Overload Voltage 最大过负荷 电压 | Dielectric Withstanding Voltage 绝缘耐压 | Resistance Range 阻值范围 | Tolerance 公差 |
|-----------------------------------|-----------|-----------------------------|--------------------|----------|--------|-----|----|--|--|---|-----------------------------|--------------------|
| | | | D | L | d±0.05 | H±3 | PT | | | | | |
| Ordinary Products(普通产品) | | | | | | | | | | | | |
| CFR0W8 | CFR-12 | 1/8W | 1.9±0.3 | 3.3±0.3 | 0.45 | 28 | 52 | 200V | 400V | 400V | 1Ω~1MΩ | ±2% ±5% ±10% |
| CFR0S4 | CFR-25-S | 1/4W-S | 1.9±0.3 | 3.3±0.3 | 0.45 | 28 | 52 | 200V | 400V | 400V | 1Ω~1MΩ | |
| CFR0W4 | CFR-25 | 1/4W | 2.2±0.3 | 6.5±1.0 | 0.54 | 28 | 52 | 250V | 500V | 500V | 1Ω~10MΩ | |
| CFR0W2 | CFR-50 | 1/2W | 3.0±0.6 | 9.5±1.0 | 0.54 | 28 | 52 | 350V | 700V | 700V | 1Ω~10MΩ | |
| CFR01S | CFR-100-S | 1W-S | 4.5±0.6 | 11.5±1.0 | 0.70 | 28 | 52 | 500V | 1000V | 1000V | 1Ω~10MΩ | |
| CFR01W | CFR-100 | 1W | 5.0±0.6 | 15.5±1.0 | 0.70 | 28 | 64 | 500V | 1000V | 1000V | 1Ω~10MΩ | |
| CFR02S | CFR-200-S | 2W-S | 5.0±0.6 | 15.5±1.0 | 0.70 | 28 | 64 | 500V | 1000V | 1000V | 1Ω~10MΩ | |
| CFR02W | CFR-200 | 2W | 6.0±0.6 | 17.5±1.0 | 0.75 | 28 | 64 | 500V | 1000V | 1000V | 1Ω~10MΩ | |
| CFR03S | CFR-300-S | 3W-S | 6.0±0.6 | 17.5±1.0 | 0.75 | 28 | 64 | 500V | 1000V | 1000V | 1Ω~10MΩ | |
| High Power Products(高功率产品) | | | | | | | | | | | | |
| CPR0W2 | CPR-50 | 1/2W | 2.2±0.5 | 6.5±1.0 | 0.54 | 28 | 52 | 300V | 500V | 700V | 3Ω~10MΩ | ±2% |
| CPR01W | CPR-100 | 1W | 3.5±0.5 | 9.5±1.0 | 0.54 | 28 | 52 | 500V | 700V | 1000V | 3Ω~10MΩ | ±5% |
| CPR02W | CPR-200 | 2W | 4.5±0.5 | 11.0±1.0 | 0.70 | 28 | 52 | 500V | 1000V | 1000V | 3Ω~10MΩ | ±10% |

- Standard E-24 series values in ±5% ±10% & ±20% tolerance
标准 E-24 系列公差为 ±5%、±10% & ±20%
- Standard: Beige color, CFR1WS, CFR2WS, CFR3WS with light brown color, High Power Products with Grey-green
正常尺寸涂标准米黄色底漆, CFR1WS、CFR2WS、CFR3WS 涂浅棕色底漆, 高功率产品涂灰绿色底漆
- For any special inquiry such as too Low or too High ohmic values is available on a case to case basis
特殊要求, 含超高、超低阻值也可特别安排生产

Performance Specification(性能)

| | | |
|--|---------------|---|
| Temperature coefficient | 温度系数 | ≤10 Ω: ±300PPM/°C; 11Ω~99KΩ: ±450PPM/°C 100KΩ~1MΩ: 0~700PPM/°C; 1.1MΩ~10MΩ: 0~1500PPM/°C; |
| Short-time Overload | 短时间过负荷 | CFR Products (CFR 产品): ΔR/R ≤ ±(1%+0.05 Ω) CPR Products (CPR 产品): ΔR/R ≤ ±(0.75%+0.05 Ω) |
| Dielectric withstanding voltage | 绝缘耐压 | With no evidence of flashover,mechanical damage,arcing or insulation breakdown (无击穿·飞弧及可见机械损伤) |
| Terminal strength | 端子强度 | No evidence of mechanical damage (无可见机械损伤) |
| Soldering heat | 耐焊接热 | ΔR/R ≤ ±(1%+0.05 Ω) with no evidence of mechanical damage (无可见机械损伤) |
| Solderability | 可焊性 | Min.95% coverage (最少 95% 覆盖率) |
| Resistance to solvent | 耐溶剂 | No deterioration of protective coating and markings (包封层, 色码完整) |
| Temperature cycling | 温度循环 | ΔR/R ≤ ±(1%+0.05 Ω) with no evidence of mechanical damage (无可见机械损伤) |
| Load life in humidity | 湿度寿命 | CFR Ordinary Products (CFR 普通产品): ΔR/R ±3%for < 100kΩ, ±5% for ≥100kΩ CFR Flame retardant type(CFR 阻燃性产品): ΔR/R ±5%for < 100kΩ, ±10%for ≥100kΩ High Power Products (高功率产品):ΔR/R ±(3%+0.05Ω) |
| Load life | 负载寿命 | CFR Ordinary Products (普通产品): ΔR/R ±2%for < 56kΩ, ±3%for ≥56kΩ CFR Flame retardant type (CFR 阻燃性产品): ΔR/R ±5%for < 100kΩ, ±10%for ≥100kΩ High Power Products (高功率产品):ΔR/R ±(3%+0.05Ω) |

Ordering Procedure (Example: CFR 1/4WS 5% 10Ω T/B-5000)

订购方式 (例如: CFR1/4WS 5% 10Ω T/B-5000)

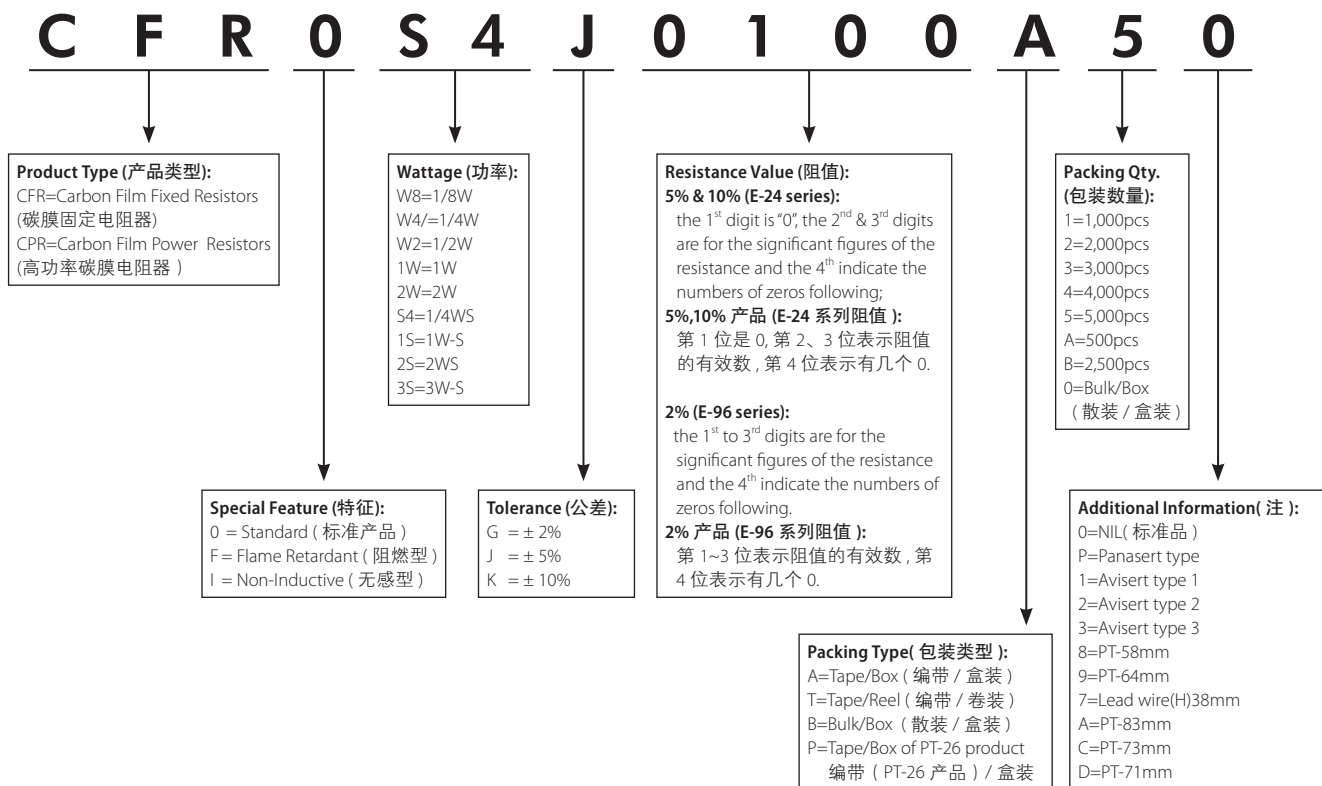

Feature (特性)

- EIA standard color. EIA标准色码
- Flame Retardant type available 可提供不燃性漆
- Low noise & voltage coefficient 噪声低，电压系数小
- Low temperature coefficient range 温度系数低
- Multiple epoxy coating on vacuum-deposited metal film provides superior moisture protection
真空溅射金属皮膜涂多层环氧树脂，防水性效果好
- Nichrome resistive element provides stable performance in various environments
镍基金属膜层的采用使各项性能更加稳定



Dimension(尺寸) mm



Derating Curve (降功率曲线)

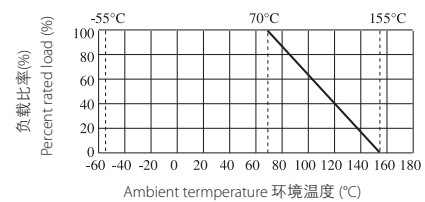

Specification(性能)

| Part No 料号 | Type 类型 | Power Rating 功率 70°C | Dimension (尺寸)(mm) | | | | | MAX. Working Voltage 最大工作电压 | MAX. Overload Voltage 最大过负荷电压 | Dielectric Withstanding Voltage 绝缘耐压 |
|---------------|------------|-------------------------|--------------------|----------|--------|-----|----|--------------------------------|----------------------------------|---|
| | | | D | L | d±0.05 | H±3 | PT | | | |
| MF0W8 | MF-12 | 1/8W | 1.9±0.3 | 3.3±0.3 | 0.45 | 28 | 52 | 200V | 400V | 400V |
| MF0S4 | MF-25-S | 1/4W-S | 1.9±0.3 | 3.3±0.3 | 0.45 | 28 | 52 | | | |
| MF004 | MF-40-SS | 0.4W-SS | 1.9±0.5 | 3.3±0.3 | 0.45 | 28 | 52 | 200V | 400V | 400V |
| MF0W4 | MF-25 | 1/4W | 2.2±0.3 | 6.5±1.0 | 0.54 | 28 | 52 | 250V | 500V | 500V |
| MF0S2 | MF-50-S | 1/2W-S | 2.2±0.5 | 6.5±1.0 | 0.54 | 28 | 52 | 250V | 500V | 250V |
| MF0W2 | MF-50 | 1/2W | 3.0±0.6 | 9.5±1.0 | 0.54 | 28 | 52 | 350V | 700V | 700V |
| MF006 | MF-60-S | 0.6W-S | 2.2±0.5 | 6.5±1.0 | 0.54 | 28 | 52 | 250V | 500V | 500V |
| MF01S | MF-100-S | 1W-S | 3.0±0.6 | 9.5±1.0 | 0.54 | 28 | 52 | 350V | 700V | 700V |
| MF01W | MF-100 | 1W | 4.5±0.6 | 11.5±1.0 | 0.70 | 28 | 52 | 500V | 1000V | 1000V |
| MF02S | MF-200-S | 2W-S | 4.5±0.6 | 11.5±1.0 | 0.70 | 28 | 52 | 500V | 1000V | 1000V |
| MF02W | MF-200 | 2W | 5.0±0.6 | 15.5±1.0 | 0.70 | 28 | 64 | 500V | 1000V | 1000V |
| MF03S | MF-300-S | 3W-S | 5.0±0.6 | 15.5±1.0 | 0.70 | 28 | 64 | 500V | 1000V | 1000V |
| MF03W | MF-300 | 3W | 6.0±0.6 | 17.5±1.0 | 0.75 | 28 | 64 | 500V | 1000V | 1000V |

| Part No 料号 | Type 类型 | Standard Order 标准品 | | | Special Order 特殊订购品 | | |
|---------------|------------|--------------------|--------------------------|-------------|---------------------|--------------------------|-------------|
| | | Tolerance 公差 | Resistance Range 阻值范围 | TCR 温度系数 | Tolerance 公差 | Resistance Range 阻值范围 | TCR 温度系数 |
| MF0W8 | MF0W8 | ±1% | 10Ω~1MΩ | ±50 | ±0.25% | 51.1Ω~200KΩ | ±15 |
| MF0S4 | MF0S4 | ±2% | 10Ω~1MΩ | ±100 | ±0.5% | 51.1Ω~511KΩ | ±25 |
| MF004 | MF004 | ±5% | 1Ω~1MΩ | ±200 | ±0.5% | 51.1Ω~511KΩ | ±50 |
| MF0W4 | MF-25 | ±1% | 10Ω~1MΩ | ±50 | ±0.1% | 10Ω~1MΩ | ±15 |
| MF0S2 | MF-50-S | ±2% | 1Ω~1MΩ | ±100 | ±0.25% | 10Ω~1MΩ | ±25 |
| MF006 | MF-60-S | ±5% | 1Ω~1MΩ | ±200 | ±0.5% | 10Ω~1MΩ | ±50 |
| MF0W2 | MF-50 | ±1% | 10Ω~1MΩ | ±50 | ±0.1% | 100Ω~330KΩ | ±15 |
| MF01S | MF-100-S | ±2% | 10Ω~1MΩ | ±100 | ±0.25% | 51.1Ω~511KΩ | ±25 |
| | | ±5% | 1Ω~1MΩ | ±200 | ±0.5% | 10Ω~1MΩ | ±50 |
| MF01W | MF-100 | ±1% | 51.1Ω~1MΩ | ±50 | ±0.1% | 100Ω~330KΩ | ±15 |
| MF02S | MF-200-S | ±2% | 51.1Ω~1MΩ | ±100 | ±0.25% | 51.1Ω~511KΩ | ±25 |
| MF02W | MF-200 | | | | | | |
| MF03S | MF-300-S | | | | | | |
| MF03W | MF-300 | ±5% | 1Ω~1MΩ | ±200 | ±0.5% | 51.1Ω~1MΩ | ±50 |

Performance Specification(性能)

| | | |
|---------------------------------|--------|--|
| Temperature coefficient | 温度系数 | Reference table(参考上表) |
| Short-time Overload | 短时间过负荷 | $\Delta R/R \leq \pm(0.5\%+0.05\Omega)$, with no evidence of mechanical damage (无可见机械损伤) |
| Dielectric withstanding voltage | 绝缘耐压 | With no evidence of flashover, mechanical damage, arcing or insulation breakdown (无击穿·飞弧及可见机械损伤) |
| Pulse Overload | 脉冲过负荷 | $\Delta R/R \leq \pm(1\%+0.05)$, with no evidence of mechanical damage (无可见机械损伤) |
| Terminal strength | 端子强度 | No evidence of mechanical damage (无可见机械损伤) |
| Soldering heat | 耐焊接热 | $\Delta R/R \leq \pm(1\%+0.05\Omega)$ with no evidence of mechanical damage (无可见机械损伤) |
| Solderability | 可焊性 | Min.95% coverage (最少95%覆盖率) |
| Resistance to solvent | 耐溶剂 | No deterioration of protective coating and markings (封装层, 色码完整) |
| Temperature cycling | 温度循环 | $\Delta R/R \leq \pm(1\%+0.05\Omega)$ with no evidence of mechanical damage (无可见机械损伤) |
| Load life in humidity | 湿度寿命 | Normal type(普通型): $\Delta R/R \leq \pm 1.5\%$ & Flame retardant type(阻燃性): $\Delta R/R \leq \pm 5\%$ |
| Load life | 负载寿命 | Normal type(普通型): $\Delta R/R \leq \pm 1.5\%$ & Flame retardant type(阻燃性): $\Delta R/R \leq \pm 5\%$ |

Ordering Procedure (Example: MF 1/8W 1% 47.5K Ω T/R-5000)

订购方式(例如: MF 1/8W 1% 47.5K Ω T/R-5000)

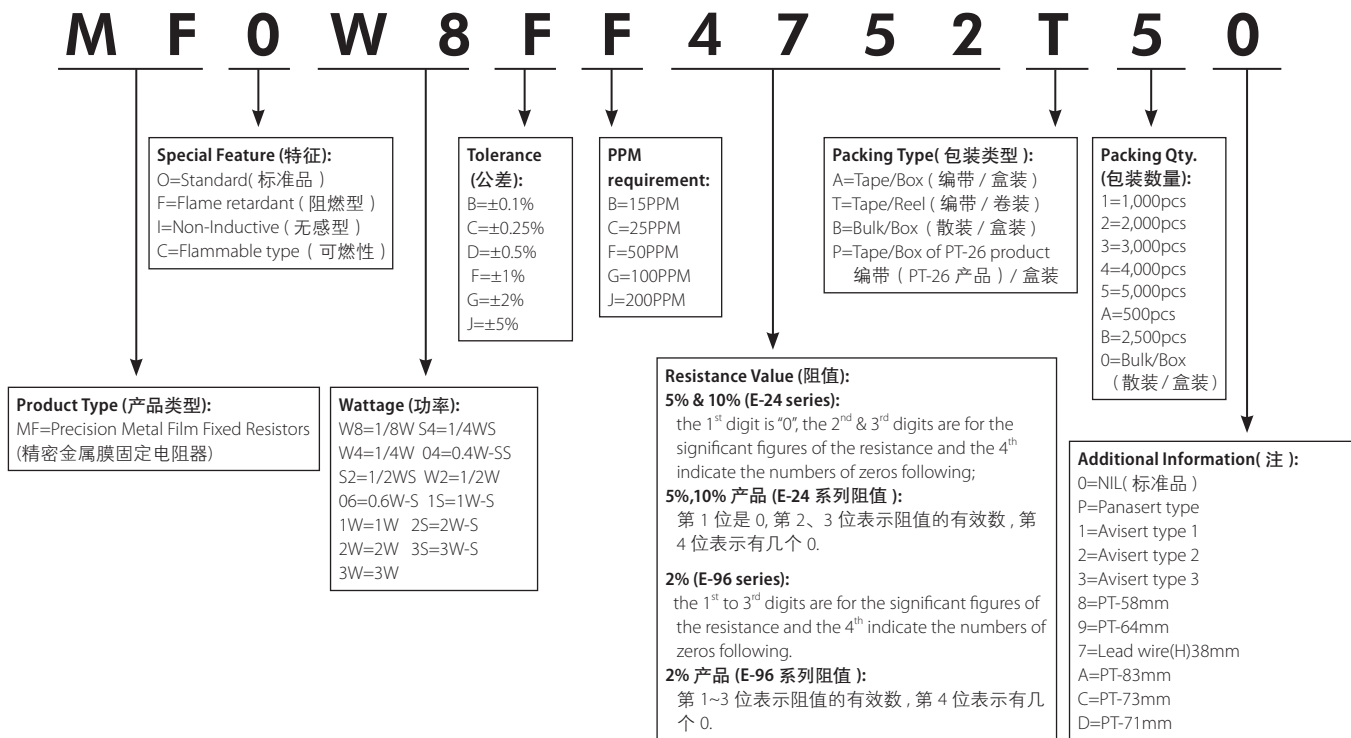

New/Old Part.no Contrast (新旧料号对照)

| New Part.no 新料号 | Old Part.no 旧料号 | New Part.no 新料号 | Old Part.no 旧料号 |
|-----------------|-----------------|-----------------|-----------------|
| MF0W8FF***A*0 | MFR0W8F***A*0 | MF01SFF***A*0 | MFR01SF***A*0 |
| MF0S4FF***A*0 | MFR0S4F***A*0 | MF01WFF***A*0 | MFR01WF***A*0 |
| MF004FF***A*0 | MFR004F***A*0 | MF02SFF***A*0 | MFR02SF***A*0 |
| MF0W4FF***A*0 | MFR0W4F***A*0 | MF02WFF***A*0 | MFR02WF***A*0 |
| MF0S2FF***A*0 | MFR0S2F***A*0 | MF03SFF***A*0 | MFR03SF***A*0 |
| MF0W2FF***A*0 | MFR0W2F***A*0 | MF03WFF***A*0 | MFR03WF***A*0 |
| MF006FF***A*0 | MFR006F***A*0 | | |

Feature (特性)

- High power in small body size 体积小功率高
- Excellent flame Retardant coating 优异阻燃性涂装
- High stability even in bad environment 恶劣环境下同样稳定工作
- Match the safety requirement 满足安全标准要求



Dimension(尺寸) mm



Derating Curve (降功率曲线)

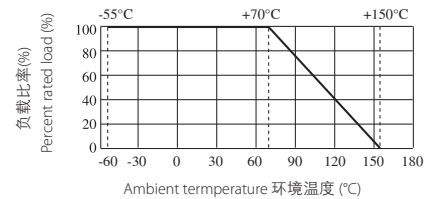

| Part No 料号 | Type 类型 | Power Rating 功率 70°C | Dimension (尺寸)(mm) | | | | | MAX.Working Voltage 最大工作电压 | MAX.Overload Voltage 最大过负荷电压 | Dielectric Withstanding Voltage 绝缘耐压 | Resistance Range 阻值范围 |
|---------------|------------|----------------------------|--------------------|----------|--------|-----|----|-------------------------------|---------------------------------|---|--------------------------|
| | | | D | L | d±0.05 | H±3 | PT | | | | |
| PMR01S | PMR-100-S | 1WS | 2.2±0.5 | 6.5±1.0 | 0.54 | 28 | 52 | 500V | 600V | 350V | 10Ω~10MΩ |
| PMR02S | PMR-200-S | 2WS | 4.0±0.6 | 11.0±1.0 | 0.70 | 28 | 52 | 500V | 600V | 350V | 3.9Ω~680KΩ |
| PMR03S | PMR-300-S | 3WS | 5.0±0.6 | 15.5±1.0 | 0.75 | 28 | 64 | 750V | 800V | 350V | 12Ω~180KΩ |

Performance Specification(性能)

| | | |
|--------------------------------|---------------|--|
| Temperature coefficient | 温度系数 | 1WS: ±200PPM/°C (±2%); ±250PPM/°C (±5%) 2WS: ±350PPM/°C (3.9Ω~100KΩ); ±400PPM/°C (101KΩ~680KΩ) 3WS: ±350PPM/°C (12Ω~100KΩ); ±400PPM/°C (101KΩ~180KΩ) |
| Short-time Overload | 短时间过负荷 | ΔR/R ≤ ±(2%+0.05 Ω), with no evidence of mechanical damage (无可见机械损伤) |
| Terminal strength | 端子强度 | with no evidence of mechanical damage (无可见机械损伤) |
| Soldering heat | 耐焊接热 | ΔR/R ≤ ±(1%+0.05 Ω), with no evidence of mechanical damage (无可见机械损伤) |
| Solderability | 可焊性 | Min.95% coverage (最少95%覆盖率) |
| Temperature cycling | 温度循环 | ΔR/R ≤ ±(2%+0.05 Ω) with no evidence of mechanical damage (无可见机械损伤) |
| Load life in humidity | 湿度寿命 | 1WS: ΔR/R ≤ ±(5%+0.05 Ω) Max; 2WS&3WS: <100KΩ: ΔR/R ≤ ±(5%+0.05 Ω) Max ≥100KΩ: ΔR/R ≤ ±(10%+0.05 Ω) Max |
| Load life | 负载寿命 | 1WS: ΔR/R ≤ ±(5%+0.05 Ω) Max; 2WS&3WS: <100KΩ: ΔR/R ≤ ±(5%+0.05 Ω) Max ≥100KΩ: ΔR/R ≤ ±(10%+0.05 Ω) Max |
| Flame retardant | 阻燃 | Resistor insulation is self-extinguishing within 10 seconds after externally applied flame is removed 火焰移开后 10 秒内, 电阻自动绝燃, 无可见火焰 |

Ordering Procedure (Example: PMR1WS 5% 100Ω T/B-5000)

订购方式 (例如: PMR1WS 5% 100Ω T/B-5000)

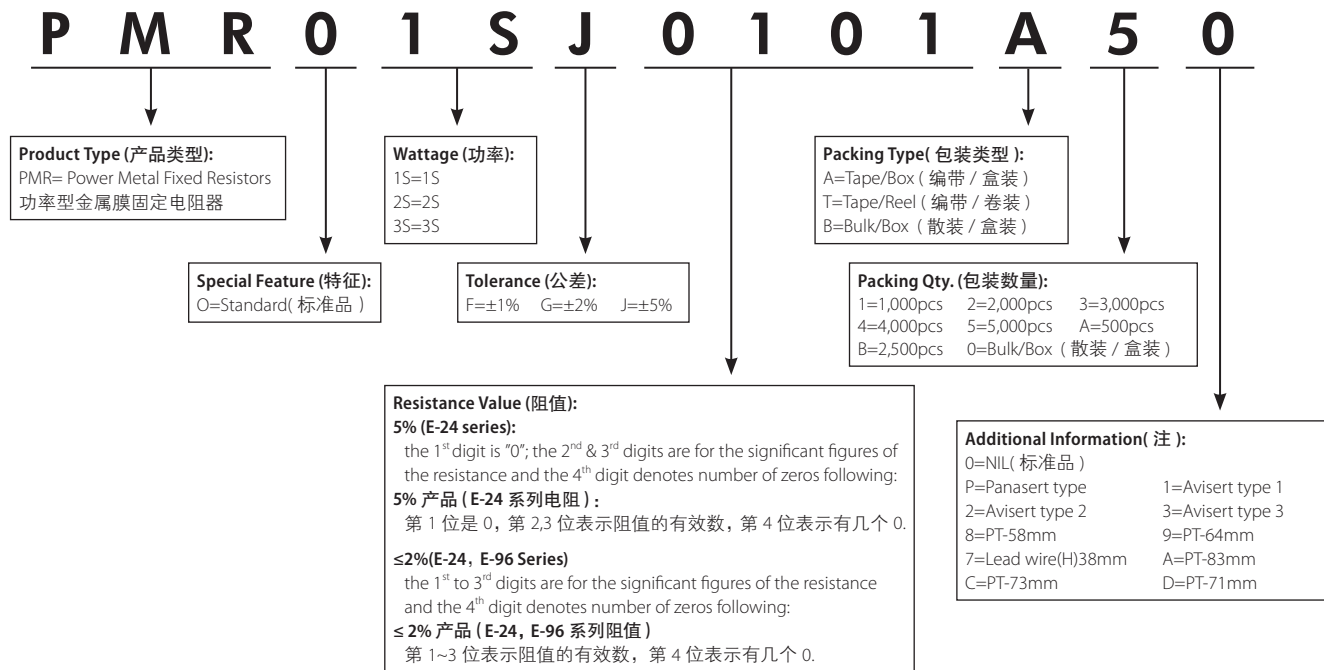

New/Old Part.no Contrast (新旧料号对照)

| New Part.no 新料号 | Old Part.no 旧料号 |
|-----------------|-----------------|
| PMR01SJ****A*0 | MPR01WJ****A*0 |
| PMR03SJ****A*0 | MPR03WJ****A*0 |

Feature (特性)

- Excellent flame retardant coating 优异不燃性涂装
- High stability even in bad environment 恶劣环境下同样稳定工作
- High purity ceramic core 高纯度瓷芯
- Meet EIA-RC2655A requirements 满足EIA-RC2655A标准要求
- High safety standard 满足安全性标准要求



Dimension(尺寸) mm



Derating Curve (降功率曲线)

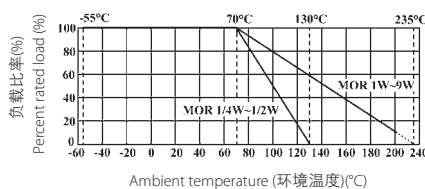

Heat Rise Chart (表面温升)

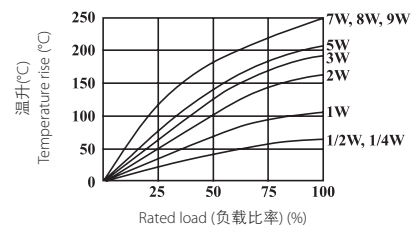

Specification(性能)

| Part No. 料号 | Type 类型 | Power Rating 功率 70°C | Dimension (尺寸)(mm) | | | | | MAX. Working Voltage 最大工作电压 | MAX. Overload Voltage 最大过负荷电压 | Dielectric Withstanding Voltage 绝缘耐压 | Resistance Range 阻值范围 |
|----------------|------------|----------------------------|--------------------|----------|---------|-----|-----|--------------------------------------|--|---|-----------------------------|
| | | | D | L | d ±0.05 | H±3 | PT | | | | |
| MOR0W4 | MOR-25 | 1/4W | 2.2±0.5 | 6.5±1.0 | 0.54 | 28 | 52 | 250V | 400V | 250V | 0.1Ω~470KΩ |
| MOR0S2 | MOR-50-S | 1/2W-S | 2.2±0.5 | 6.5±1.0 | 0.54 | 28 | 52 | 250V | 400V | 250V | 0.1Ω~470KΩ |
| MOR0W2 | MOR-50 | 1/2W | 3.0±0.6 | 9.5±1.0 | 0.54 | 28 | 52 | 250V | 400V | 250V | 0.1Ω~560KΩ |
| MOR01S | MOR-100-S | 1W-S | 3.5±0.6 | 9.5±1.0 | 0.54 | 28 | 52 | 350V | 600V | 350V | 0.1Ω~560KΩ |
| MOR01W | MOR-100 | 1W | 4.5±0.6 | 11.5±1.0 | 0.70 | 28 | 52 | 350V | 600V | 350V | 0.1Ω~560KΩ |
| MOR02S | MOR-200-S | 2W-S | 4.5±0.6 | 11.5±1.0 | 0.70 | 28 | 52 | 350V | 600V | 350V | 0.1Ω~560KΩ |
| MOR02W | MOR-200 | 2W | 5.0±0.6 | 15.5±1.0 | 0.70 | 28 | 64 | 350V | 600V | 350V | 0.1Ω~560KΩ |
| MOR03S | MOR-300-S | 3W-S | 5.0±0.6 | 15.5±1.0 | 0.70 | 28 | 64 | 350V | 600V | 350V | 0.1Ω~560KΩ |
| MOR03W | MOR-300 | 3W | 6.0±0.6 | 17.5±1.0 | 0.75 | 28 | 64 | 500V | 800V | 500V | 0.1Ω~560KΩ |
| MOR05S | MOR-500-S | 5W-S | 6.0±0.6 | 17.5±1.0 | 0.75 | 28 | 64 | 500V | 800V | 500V | 0.1Ω~560KΩ |
| MOR05W | MOR-500 | 5W | 8.0±0.6 | 24.5±1.0 | 0.75 | 38 | 90 | 750V | 1000V | 750V | 0.1Ω~680KΩ |
| MOR07W | MOR-700 | 7W | 8.0±0.6 | 29.5±1.0 | 0.75 | 38 | B/B | 750V | 1000V | 750V | 20Ω~150KΩ |
| MOR08W | MOR-800 | 8W | 8.0±0.6 | 39.5±1.0 | 0.75 | 38 | B/B | 750V | 1000V | 750V | 30Ω~200KΩ |
| MOR09W | MOR-900 | 9W | 8.0±0.6 | 52.5±1.0 | 0.75 | 38 | B/B | 750V | 1000V | 750V | 50Ω~200KΩ |

- Standard E-24 Series ±5% tolerance 标准 E-24 系列 ±5% 公差阻值
- Standard Gray base color for Normal Size product, Blue color for Small Size product 正常尺寸产品涂灰色底漆, 小尺寸产品涂海蓝色底漆
- Standard Non-Flammable coating 标准不燃性涂装
- Non-Inductive type available on a case to case basis 无感, 可特别生产

Performance Specification(性能)

| | | |
|--|--------|---|
| Temperature coefficient | 温度系数 | 1/4W,1/2WS: $\leq 100K\Omega$: $\pm 350PPM/^{\circ}C$; $100K\Omega < R \leq 470K\Omega$: $0 \sim 700PPM/^{\circ}C$ 1/2W,1WS: $\leq 120K\Omega$: $\pm 350PPM/^{\circ}C$; $120K\Omega < R \leq 560K\Omega$: $0 \sim 700PPM/^{\circ}C$ 1W,2W,2WS,3W,3WS,5WS: $\leq 150K\Omega$: $\pm 350PPM/^{\circ}C$; $150K\Omega < R \leq 560K\Omega$: $0 \sim 700PPM/^{\circ}C$ 5W; $\leq 180K\Omega$: $\pm 350PPM/^{\circ}C$; $180K\Omega < R \leq 680K\Omega$: $0 \sim 700PPM/^{\circ}C$ 7W,8W, 9W: $\pm 350PPM/^{\circ}C$ |
| Short-time Overload | 短时间过负荷 | Normal size(正常尺寸), $\Delta R/R \leq \pm(1\%+0.05\Omega)$, with no evidence of mechanical damage (无可见机械损伤) Small size(小尺寸), $\Delta R/R \leq \pm(2\%+0.05\Omega)$, with no evidence of mechanical damage (无可见机械损伤) |
| Dielectric withstanding voltage | 绝缘耐压 | No evidence of flashover,mechanical damage,arcing or insulation breakdown (无击穿、飞弧及可见机械损伤) |
| Pulse Overload | 脉冲过负荷 | Normal size(正常尺寸), $\Delta R/R \leq \pm(2\%+0.05\Omega)$, with no evidence of mechanical damage (无可见机械损伤) Small size(小尺寸), $\Delta R/R \leq \pm(5\%+0.05\Omega)$, with no evidence of mechanical damage (无可见机械损伤) |
| Terminal strength | 端子强度 | No evidence of mechanical damage (无可见机械损伤) |
| Soldering heat | 耐焊接热 | $\Delta R/R \leq \pm(1\%+0.05\Omega)$, with no evidence of mechanical damage (无可见机械损伤) |
| Solderability | 可焊性 | Min.95% coverage (最少 95% 覆盖率) |
| Resistance to solvent | 耐溶剂 | No deterioration of protective coating and markings (包封层, 色码完整) |
| Temperature cycling | 温度循环 | $\Delta R/R \leq \pm(2\%+0.05\Omega)$ with no evidence of mechanical damage (无可见机械损伤) |
| Humidity (Steady State) | 恒定湿热 | $\Delta R/R \leq \pm(2\%+0.05\Omega)$ with no evidence of mechanical damage (无可见机械损伤) |
| Load life in humidity | 湿度寿命 | $< 100k\Omega$: $\pm(5\%+0.05\Omega)$ MAX, $\geq 100k\Omega$: $\pm(10\%+0.05\Omega)$ MAX; |
| Load life | 负载寿命 | $< 100k\Omega$: $\pm(5\%+0.05\Omega)$ MAX, $\geq 100k\Omega$: $\pm(10\%+0.05\Omega)$ MAX; |
| Flame retardant | 阻燃 | Resistor insulation is self-extinguishing within 10 seconds after externally applied flame is removed (火焰移开后 10 秒内, 电阻自动绝燃, 无可见火焰) |

Ordering Procedure (Example: MOR 1W-S 5% 8.2 Ω T/B-1000)

订购方式 (例如: MOR 1W-S 5% 8.2 Ω T/B-1000)

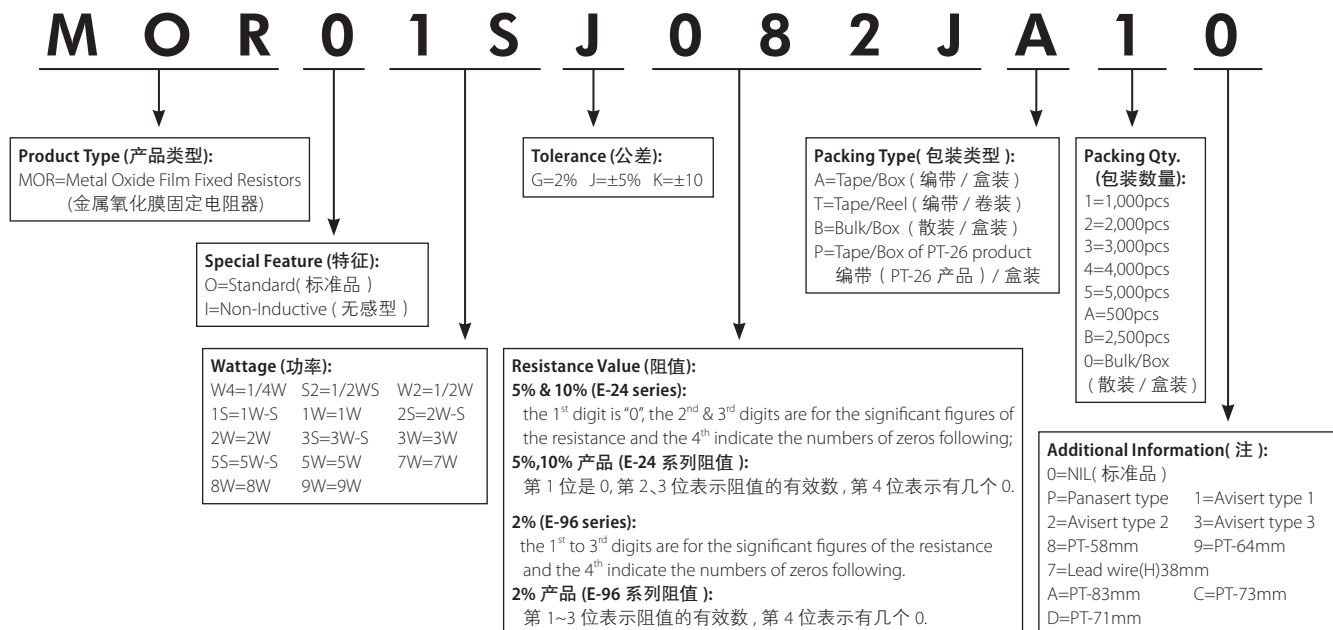

Feature (特性)

- Excellent flame retardant coating 优异不燃性涂装
- High Stability even in bad environment 恶劣环境下同样稳定工作
- High purity ceramic core 高纯度瓷芯
- High safety standard 电器性能稳定
- Meet EIAJ-RC2655A requirements 达到 EIAJ-RC2655A 标准要求
- Too low or too high ohmic value can be provided on a case to case basis 超低或超高阻值也能特别提供



Vertical type - TMOV

端片 MOR 电阻-立式 (TMOV)

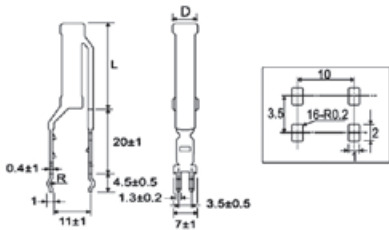

"L" type terminal - TMOL

端片 MOR 电阻-L型端片 (TMOL)

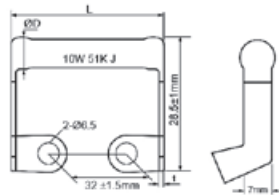

Radial type - TMOR

端片 MOR 电阻-卧式 (TMOR)

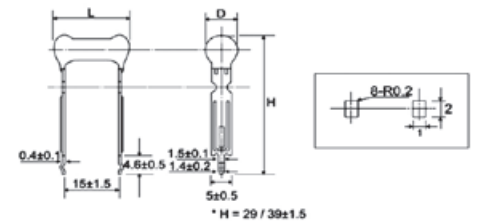

Specification(性能)

| Part No 料号 | Type 类型 | Power Rating 功率 70°C | Dimension(尺寸) (mm) | | MAX. Working Voltage 最大工作电压 | MAX. Overload Voltage 最大过负荷电压 | Resistance Range 阻值范围 | Tolerance 精度 (%) |
|---------------|------------|----------------------------|------------------------|----------|-----------------------------------|-------------------------------------|-----------------------------|---------------------|
| | | | L | D | | | | |
| TMOV5W | TMOV-500 | 5W | 20 | 7 | 500V | 800V | ≤ 10Ω 10Ω~10KΩ | ±10% ±5% |
| TMOV7W | TMOV-700 | 7W | 30 | 7 | 500V | 800V | ≤ 10Ω 10Ω~10KΩ | ±10% ±5% |
| TMOLAW | TMOL-10W | 10W | 46Max 最大 | 10Max 最大 | 500V | 800V | 100Ω~82KΩ | ±5% |
| TMOL13 | TMOL-13W | 13W | 47 | 10 | 750V | 1000V | 100Ω~82KΩ | ±5% |
| TMOR3W | TMOR-300 | 3W | 16 | 6 | 350V | 600V | ≤ 10Ω 10Ω~43KΩ | ±10% ±5% |
| TMOR5W | TMOR-500 | 5W | 18 | 7 | 500V | 800V | ≤ 10Ω 10Ω~43KΩ | ±10% ±5% |

Ordering Procedure (Example: TMOV5W 5% 1KΩ B/B)

订购方式 (例如: TMOV5W 5% 1KΩ B/B)

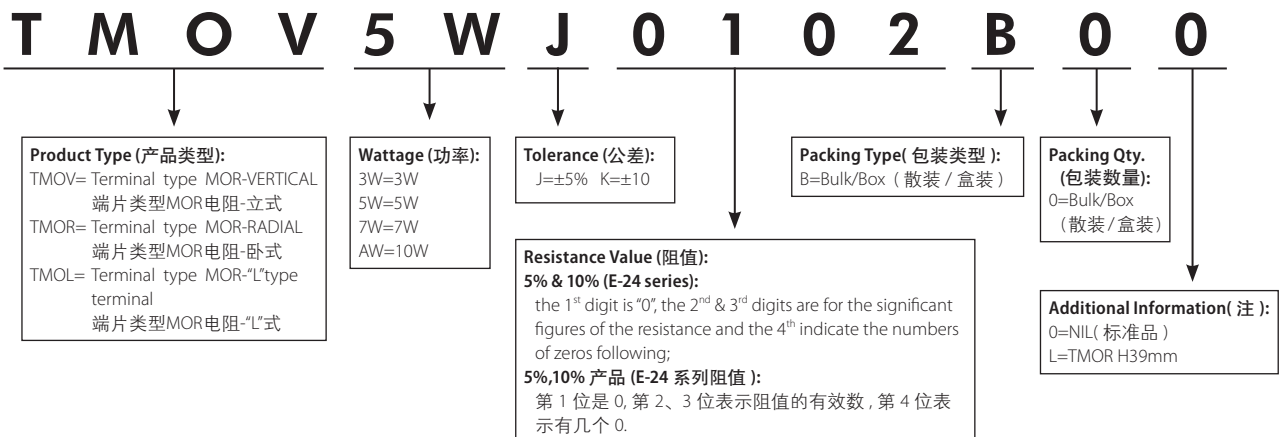

Feature (特性)

- Provide high stable performance against environment conditions & overload voltage
耐高压，稳定性强，抗湿热高温环境
- Can withstand High Surge Voltage 可承受高浪涌电压
- Wide resistance range & low TCR 阻值范围宽，温度系数低
- VDE items available (File NO:40003686、A414、D708、A759)
产品VDE认证（认证号：40003686、A414、D708、A759）
- UL items available (File NO:20130925-E364163、E244546)
产品UL安规认证（认证号：20130925-E364163、E244546）

5band color code for $\pm 5\%$ tolerance, and last band Black color for identification
公差 $\pm 5\%$ 有五道色码，最后一道以黑色标示

Standard 5 band color code for $\pm 1\%$ tolerance
公差 $\pm 1\%$ 有五道色码



Dimension (尺寸) mm

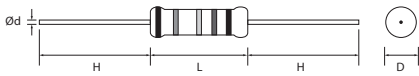

Surge Withstanding Voltage (承受浪涌电压)

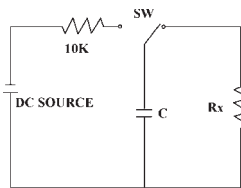

Derating Curve (降功率曲线)

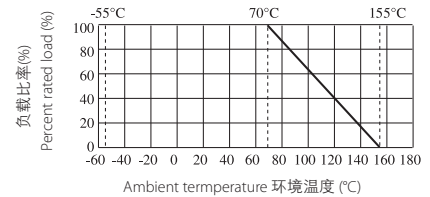

- Normal size: The discharge cycle is repeated in above circuit: 2.5 seconds "ON", 2.5 "OFF", 50 cycles, C=0.001uf.
正常尺寸：右图中充放电回路：2.5秒“通”，2.5秒“断”，50次循环，电容容值 C=0.001uf.
- Small Size: The discharge cycle is repeated in above circuit: 2.5 seconds "ON", 2.5 seconds "OFF", 10 cycles, C=0.01uf.
小型化产品：右图中充放电回路：2.5秒“通”，2.5秒“断”，10次循环，电容容值 C=0.01uf.
- The applied DC source voltage is shown as below table. 电路中的直流电压如下表“承受浪涌电压”所述。

Specification (性能)

| Part No 料号 | Type 类型 | Power Rating 功率 70 °C | Dimension (尺寸)(mm) | | | | MAX. Working Voltage 最大工作 电压 | MAX. Overload Voltage 最大过 负荷电压 | Dielectric Withstanding Voltage 绝缘耐压 | Surge Withstanding Voltage 浪涌电压 | Resistance Range 阻值范围 |
|---|------------|-----------------------------|--------------------|----------------|--------------|-----------|--|--|---|--|--|
| | | | D | L | d ± 0.05 | H ± 3 | | | | | |
| Normal Size(正常尺寸) | | | | | | | | | | | |
| MGR0W4 | MGR-25 | 1/4W | 2.5 \pm 0.5 | 6.5 \pm 1.0 | 0.60 | 28 | 1,600V | 2,000V | 700V | | 1K Ω ~510M Ω ($\pm 5\%$, $\pm 10\%$) |
| MGR0W2 | MGR-50 | 1/2W | 3.5 \pm 0.6 | 9.5 \pm 1.0 | 0.60 | 28 | 3,500V | 4,000V | 700V | | $\leq 10M\Omega$ ($\pm 1\%$) 10M~100M($\pm 2\%$) |
| MGR01W | MGR-100 | 1W | 4.0 \pm 0.6 | 11.5 \pm 1.0 | 0.75 | 28 | 3,500V | 4,000V | 700V | $\geq 100K\Omega$ 10000V | 1K Ω ~1G Ω ($\pm 5\%$, $\pm 10\%$) $\leq 10M\Omega$; $\pm 1\%$ |
| MGR02W | MGR-200 | 2W | 5.0 \pm 0.6 | 15.5 \pm 1.0 | 0.80 | 28 | 3,500V | 4,000V | 700V | | 10M~100M($\pm 2\%$) 101M~510M($\pm 5\%$) |
| MGR03W | MGR-300 | 3W | 6.0 \pm 0.6 | 17.5 \pm 1.0 | 0.80 | 28 | 3,500V | 4,000V | 700V | | 1K Ω ~100M Ω ($\pm 5\%$, $\pm 10\%$) 100K~1M($\pm 1\%$) |
| Small Size&Ultra Small Size(小型尺寸) | | | | | | | | | | | |
| MGR0S2 | MGR-50-S | 1/2W-S | 2.2 \pm 0.5 | 6.5 \pm 1.0 | 0.60 | 28 | 500V | 700V | 500V | 100K Ω ~1M:3000V 1M1~6M2: 4000V $\geq 6M8$: 6000V | |
| MGR01S | MGR-100-S | 1W-S | 3.5 \pm 0.6 | 9.5 \pm 1.0 | 0.60 | 28 | 700V | 1000V | 700V | 100K Ω ~1M:4000V 1M1~6M2: 5000V $\geq 6M8$: 8000V | 1K Ω ~33M Ω ($\pm 5\%$, $\pm 10\%$) |
| MGR02S | MGR-200-S | 2W-S | 4.5 \pm 0.6 | 11.5 \pm 1.0 | 0.75 | 28 | 1000V | 1400V | 700V | 100K Ω ~1M:5000V 1M1~6M2: 6000V $\geq 6M8$: 9000V | 100K Ω ~1M Ω ($\pm 1\%$) |
| MGR03U | MGR-300-SS | 3W-SS | 4.5 \pm 0.6 | 11.5 \pm 1.0 | 0.75 | 28 | 1000V | 1400V | 700V | | |
| MGR03S | MGR-300-S | 3W-S | 5.0 \pm 0.6 | 15.5 \pm 1.0 | 0.80 | 28 | 1000V | 1400V | 700V | 100K Ω ~1M:8000V 1M1~6M2: 9000V $\geq 6M8$: 10000V | |

Performance Specification(性能)

| | | |
|---------------------------------|--------|--|
| Temperature coefficient | 温度系数 | ≤±200PPM°C |
| Short-time Overload | 短时间过负荷 | ΔR/R ≤ ±(1%+0.05 Ω), with no evidence of mechanical damage (无可见机械损伤) |
| Dielectric withstanding voltage | 绝缘耐压 | With no evidence of flashover, mechanical damage, arcing or insulation breakdown (无击穿·电弧及可见机械损伤) |
| Pulse Overload | 脉冲过负荷 | ΔR/R ≤ ±(2%+0.05), with no evidence of mechanical damage (无可见机械损伤) |
| Terminal strength | 端子强度 | No evidence of mechanical damage (无可见机械损伤) |
| Soldering heat | 耐焊接热 | ΔR/R ≤ ±(1%+0.05 Ω) with no evidence of mechanical damage (无可见机械损伤) |
| Solderability | 可焊性 | Min.95% coverage (最少 95% 覆盖率) |
| Resistance to solvent | 耐溶剂 | No deterioration of protective coating and marking (包封层, 色码完整) |
| Temperature cycling | 温度循环 | ΔR/R ≤ ±(1%+0.05 Ω) with no evidence of mechanical damage (无可见机械损伤) |
| Load life in humidity | 湿度寿命 | ΔR/R ≤ ±(5%+0.05 Ω) with no evidence of mechanical damage (无可见机械损伤) |
| Load life | 负载寿命 | ΔR/R ≤ ±(5%+0.05 Ω) with no evidence of mechanical damage (无可见机械损伤) |
| Surge Withstanding Voltage | 尖峰脉冲 | ΔR/R ≤ ±(20%+0.05 Ω) with no evidence of mechanical damage (无可见机械损伤) |

Ordering Procedure (Example: MGR 1W 5% 27MΩ T/B-1000)

订购方式 (例如: MGR 1W 5% 27MΩ T/B-1000)

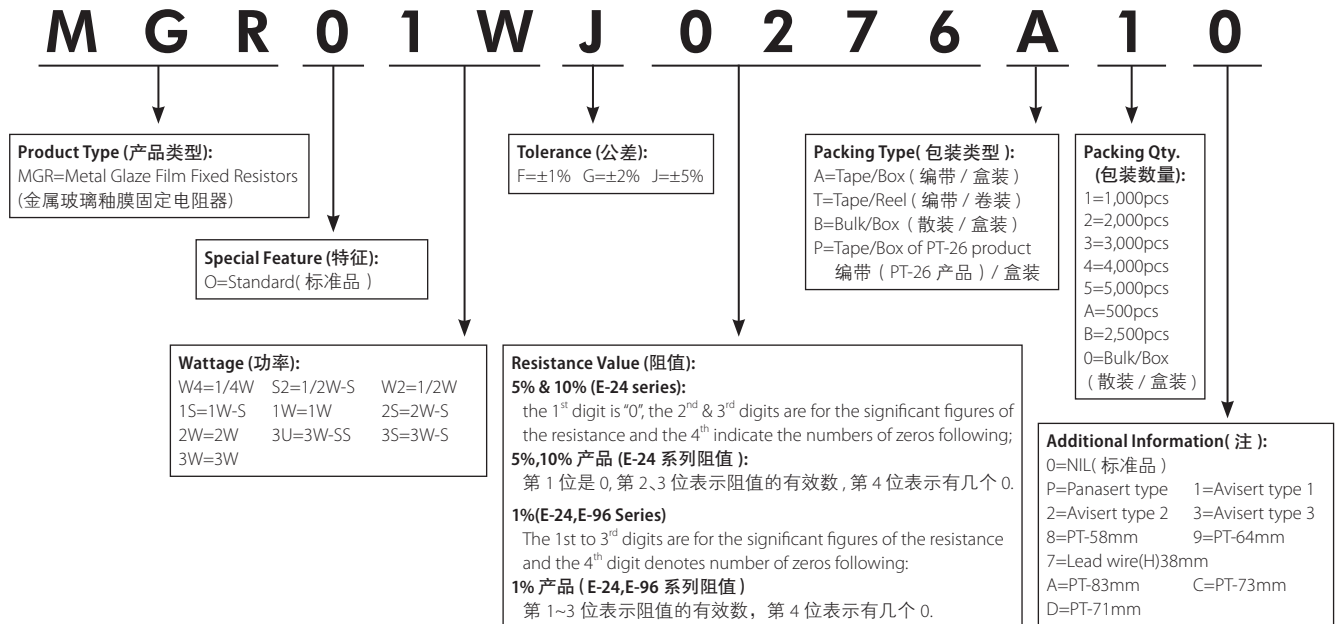

New/Old Part.no Contrast (新旧料号对照)

| New Part.no 新料号 | Old Part.no 旧料号 |
|-----------------|-----------------|
| MGR0**J***** | HMGR**J***** |
| MGR0**J***** | HVR0**J***** |
| MGR*S2***** | MGR*U2***** |

Feature (特性)

- Ideal circuit opening controller, disconnecting units from overload rating specified.
理想的电流过负荷保护组件
- Too low or too high ohmic value can be supplied on a case to case to case basis.
超高或超低阻值也能特别生产
- UL items available (File NO:E306074、E245468)
产品UL安规认证 (认证号: E306074、E245468)



Dimension (尺寸) mm

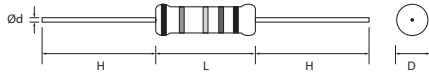

Derating Curve (降功率曲线)

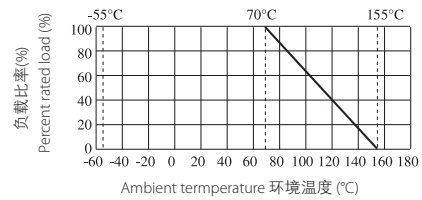

Specification (性能)

| Part No 料号 | Type 类型 | Power Rating 功率 70°C | Dimension (尺寸)(mm) | | | | | Dielectric Withstanding Voltage 绝缘耐压 | Resistance Range 阻值范围 |
|---------------|------------|-------------------------|--------------------|----------|---------|-----|----|--|--------------------------|
| | | | D | L | d ±0.05 | H±3 | PT | | |
| FRN0W4 | FRN-25 | 1/4W | 2.2±0.5 | 6.5±1.0 | 0.60 | 28 | 52 | 300V | 0.22Ω~10KΩ |
| FRN0S2 | FRN-50-S | 1/2W-S | 2.2±0.5 | 6.5±1.0 | 0.60 | 28 | 52 | 300V | 0.22Ω~10KΩ |
| FRN004 | FRN-40 | 0.4W | 2.2±0.5 | 6.5±1.0 | 0.60 | 28 | 52 | 300V | 0.22Ω~10KΩ |
| FRN0W2 | FRN-50 | 1/2W | 3.0±0.5 | 9.0±1.0 | 0.60 | 28 | 52 | 350V | 0.22Ω~10KΩ |
| FRN075 | FRN-75 | 3/4W | 3.5±0.6 | 9.5±1.0 | 0.54 | 28 | 52 | 350V | 0.22Ω~10KΩ |
| FRN01W | FRN-100 | 1W | 3.5±0.6 | 9.5±1.0 | 0.54 | 28 | 52 | 350V | 0.22Ω~10KΩ |
| FRN01A | FRN-150 | 1.5W | 4.5±0.6 | 11.5±1.0 | 0.70 | 28 | 52 | 600V | 0.22Ω~10KΩ |
| FRN02W | FRN-200 | 2W | 4.5±0.6 | 11.5±1.0 | 0.70 | 28 | 52 | 600V | 0.22Ω~10KΩ |
| FRN03W | FRN-300 | 3W | 5.0±0.6 | 15.5±1.0 | 0.80 | 28 | 64 | 600V | 0.22Ω~10KΩ |

Fusing Characteristics (熔断特性)

| Resistance Value (阻值) | Test Wattage (测试功率) | Fusing Time (熔断时间) |
|--------------------------|--------------------------|-----------------------|
| ≤2.2Ω | 32 X Power Rating (额定功率) | ≤ 60 seconds (秒) |
| >2.2Ω | 16 X Power Rating (额定功率) | ≤ 60 seconds (秒) |

The fusing test current or voltage should be stable, change within 5%. (测试电流或电压必须稳定变化率不超过 5%)

Performance Specification(性能)

| | | |
|---------------------------------|--------|--|
| Temperature coefficient | 温度系数 | ±350PPM/°C |
| Short-time Overload | 短时间过负荷 | $\Delta R/R \leq \pm(2\%+0.05 \Omega)$, with no evidence of mechanical damage (无可见机械损伤) |
| Dielectric withstanding voltage | 绝缘耐压 | With no evidence of flashover, mechanical damage, arcing or insulation breakdown (无击穿·飞弧及可可见机械损伤) |
| Terminal strength | 端子强度 | No evidence of mechanical damage (无可见机械损伤) |
| Soldering heat | 耐焊接热 | $\Delta R/R \leq \pm(1\%+0.05 \Omega)$ with no evidence of mechanical damage (无可见机械损伤) |
| Solderability | 可焊性 | Min.95% coverage (最少 95% 覆盖率) |
| Temperature cycling | 温度循环 | $\Delta R/R \leq \pm(2\%+0.05 \Omega)$ with no evidence of mechanical damage (无可见机械损伤) |
| Load life in humidity | 湿度寿命 | $\Delta R/R \leq \pm(5\%+0.05 \Omega)$ with no evidence of mechanical damage (无可见机械损伤) |
| Load life | 负载寿命 | $\Delta R/R \leq \pm(5\%+0.05 \Omega)$ with no evidence of mechanical damage (无可见机械损伤) |
| Flame retardant | 阻燃 | Resistor insulation is self-extinguishing within 10 seconds after externally applied flame is removed (火焰移开后 10S 内, 电阻自动绝燃, 无可见火焰) |

Ordering Procedure (Example: FRN 1W 5% 1Ω T/B-1000)

订购方式 (例如: FRN 1W 5% 1Ω T/B-1000)

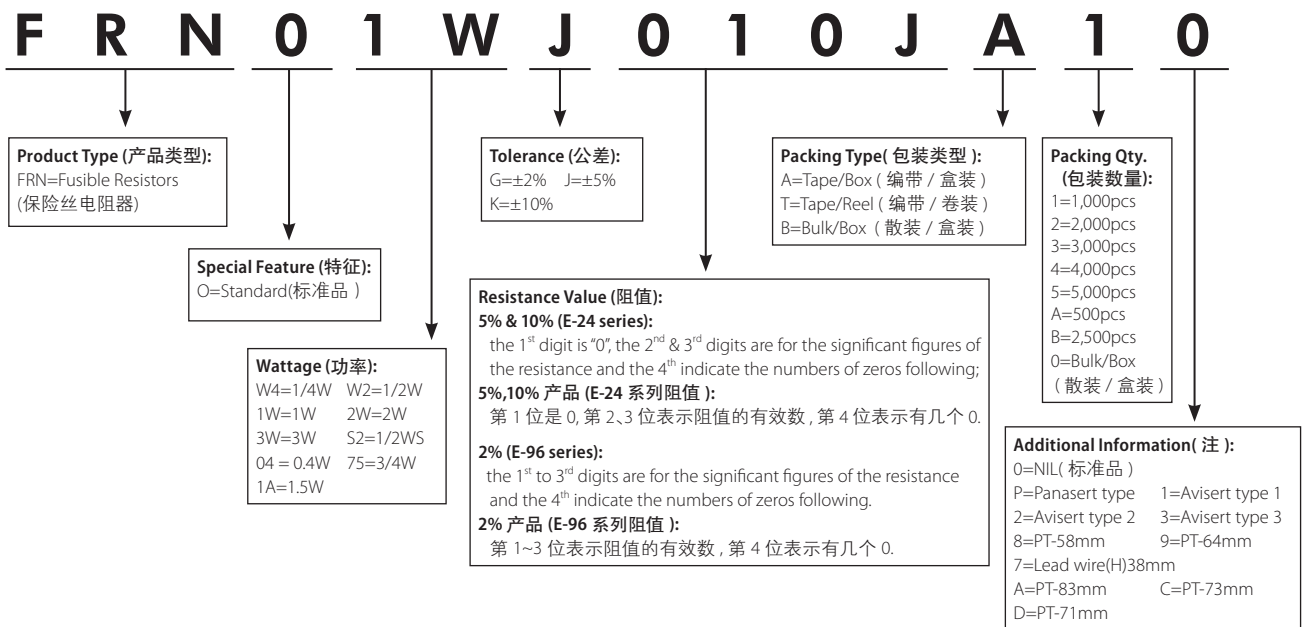

Feature (特性)

- Excellent flame retardant coating 优异不燃性涂装
- Too low or too high ohmic value can be supplied on a case to basis
超低阻值或超高阻值都可特别提供
- Non-inductive type available
可特别提供无感型产品



Dimension(尺寸) mm

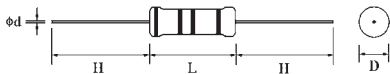

Derating Curve (降功率曲线)

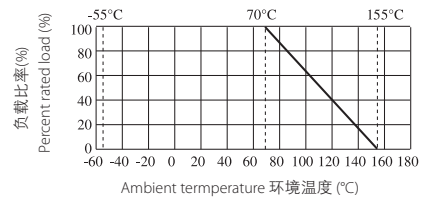

Specification(性能)

| Part No 料号 | Type 类型 | Power Rating 功率 70°C | Dimension (尺寸)(mm) | | | | | Resistance Range 阻值范围 |
|---------------|------------|-------------------------|--------------------|------|---------|-----|-----|--------------------------|
| | | | D±1 | L±1 | d ±0.05 | H±3 | PT | |
| KNP0W4 | KNP-25 | 1/4W | 2.5 | 6.5 | 0.54 | 28 | 52 | 0.01Ω~200Ω |
| KNP0S2 | KNP-50-S | 1/2WS | 2.5 | 6.5 | 0.54 | 28 | 52 | 0.01Ω~200Ω |
| KNP0W2 | KNP-50 | 1/2W | 3.0 | 9.5 | 0.54 | 28 | 52 | 0.01Ω~390Ω |
| KNP01S | KNP-100-S | 1W-S | 3.0 | 9.5 | 0.54 | 28 | 52 | 0.01Ω~390Ω |
| KNP01W | KNP-100 | 1W | 4.5 | 11.5 | 0.70 | 28 | 52 | 0.01Ω~1.2KΩ |
| KNP02S | KNP-200-S | 2W-S | 4.5 | 11.5 | 0.70 | 28 | 52 | 0.01Ω~1.2KΩ |
| KNP02W | KNP-200 | 2W | 5.5 | 15.5 | 0.70 | 28 | 64 | 0.01Ω~3.0KΩ |
| KNP03S | KNP-300-S | 3W-S | 5.5 | 15.5 | 0.70 | 28 | 64 | 0.01Ω~3.0KΩ |
| KNP03W | KNP-300 | 3W | 6.5 | 17.5 | 0.75 | 28 | 64 | 0.039Ω~3.9KΩ |
| KNP05S | KNP-500-S | 5W-S | 6.5 | 17.5 | 0.75 | 28 | 64 | 0.039Ω~3.9KΩ |
| KNP05W | KNP-500 | 5W | 8.5 | 24.5 | 0.75 | 38 | 90 | 0.082Ω~5.6KΩ |
| KNP07S | KNP-700-S | 7W-S | 8.5 | 24.5 | 0.75 | 38 | 90 | 0.082Ω~5.6KΩ |
| KNP07W | KNP-700 | 7W | 8.5 | 29.5 | 0.75 | 38 | B/B | 0.1Ω~8.2KΩ |
| KNP08S | KNP-800-S | 8W-S | 8.5 | 29.5 | 0.75 | 38 | B/B | 0.1Ω~8.2KΩ |
| KNP08W | KNP-800 | 8W | 8.5 | 39.5 | 0.75 | 38 | B/B | 0.15Ω~12KΩ |
| KNP09S | KNP-900-S | 9W-S | 8.5 | 39.5 | 0.75 | 38 | B/B | 0.15Ω~12KΩ |
| KNP09W | KNP-900 | 9W | 8.5 | 52.5 | 0.75 | 38 | B/B | 0.22Ω~15KΩ |
| KNP0AS | KNP-1000-S | 10W-S | 8.5 | 52.5 | 0.75 | 38 | B/B | 0.22Ω~15KΩ |

KNS Type (KNS型)

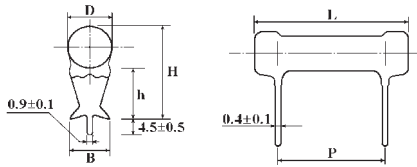

Derating Curve (降功率曲线)

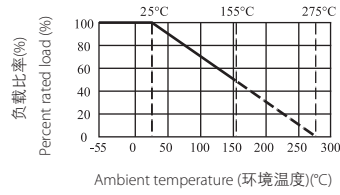

| Part No 料号 | Type 类型 | Power Rating 功率 70°C | Dimension (尺寸)(mm) | | | | | | Resistance Range 阻值范围 |
|---------------|------------|-------------------------|--------------------|-------|-------|-------|-------|-------|--------------------------|
| | | | D±1 | L±1.5 | P±1.0 | H±1.0 | h±1.0 | B±0.5 | |
| KNS02W | KNS-200 | 2W | 7.0 | 19.0 | 8 | 19 | 12 | 4.5 | 0.05Ω~470Ω |
| KNS03W | KNS-300 | 3W | 7.0 | 21.0 | 10 | 19 | 13 | 4.5 | 0.068Ω~470Ω |
| KNS05W | KNS-500 | 5W | 9.0 | 26.0 | 15 | 21.5 | 13 | 6.5 | 0.01Ω~750Ω |
| KNS07W | KNS-700 | 7W | 9.0 | 31.0 | 20 | 21.5 | 13 | 6.5 | 0.1Ω~1.1KΩ |
| KNS08W | KNS-800 | 8W | 9.0 | 41.0 | 30 | 21.5 | 13 | 6.5 | 0.2Ω~2.2KΩ |
| KNS0AW | KNS-1000 | 10W | 9.0 | 54.0 | 43 | 21.5 | 13 | 6.5 | 0.3Ω~3.3KΩ |

KNH Type (KNH型)

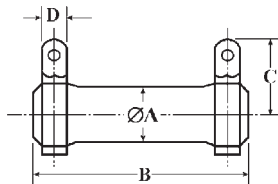

KNHA Type (KNHA型)

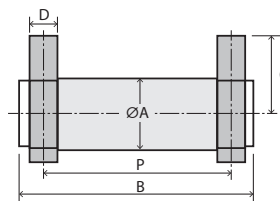

| Part No 料号 | Type 类型 | Power Rating 功率 70°C | Dimension (尺寸)(mm) | | | | Resistance Range 阻值范围 |
|---------------|------------|-------------------------|--------------------|-------|-----|-----|--------------------------|
| | | | A±1.5 | B±1.5 | C±3 | D±1 | |
| KNH020 | KNH-20W | 20W | 19 | 50 | 19 | 5 | 0.4Ω~10KΩ |
| KNH025 | KNH-25W | 25W | 19 | 60 | 19 | 5 | 0.4Ω~10KΩ |
| KNH030 | KNH-30W | 30W | 19 | 75 | 19 | 5 | 0.5Ω~15KΩ |
| KNH040 | KNH-40W | 40W | 19 | 90 | 31 | 5 | 0.6Ω~20KΩ |
| KNH050 | KNH-50W | 50W | 31 | 75 | 31 | 8 | 3Ω~25KΩ |
| | | | 28 | | | | |
| KNH060 | KNH-60W | 60W | 31 | 90 | 31 | 8 | 3Ω~30KΩ |
| | | | 28 | | | | |
| KNH080 | KNH-80W | 80W | 31 | 115 | 31 | 8 | 3Ω~40KΩ |
| | | | 28 | | | | |
| KNH.....100 | KNH-100W | 100W | 31 | 140 | 31 | 8 | 3Ω~50KΩ |
| | | | 28 | | | | |
| KNHA25 | KNHA-25W | 25W | 21 | 41 | 24 | 5 | 0.4Ω~10KΩ |
| KNHA30 | KNHA-30W | 30W | 21 | 42 | 24 | 5 | 0.4Ω~10KΩ |

Feature (特性)

- Excellent flame retardant coating 优异不燃性漆
- Too low or too high ohmic value can be supplied on a case to case basis 超低或超高阻值都可特别提供
- Non-inductive production process 无感的制作工艺



Dimension(尺寸) mm

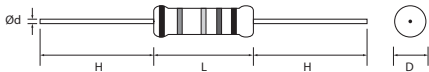

Derating Curve (降功率曲线)

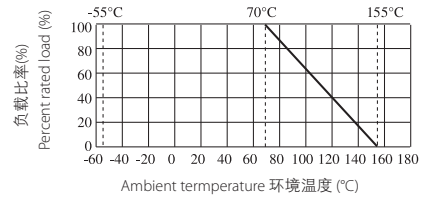

| Part No 料号 | Type 类型 | Dimension (尺寸)(mm) | | | | | Resistance Range 阻值范围 |
|---------------|-------------|--------------------|------|--------|-----|-----|--------------------------|
| | | D±1 | L±1 | d±0.05 | H±3 | PT | |
| KNPNW2 | KNPN-50 | 3.0 | 9.5 | 0.54 | 28 | 52 | 0.01Ω~30Ω |
| KNPN1S | KNPN-100-S | 3.0 | 9.5 | 0.54 | 28 | 52 | 0.01Ω~62Ω |
| KNPN1W | KNPN-100 | 4.0 | 11.5 | 0.70 | 28 | 52 | 0.018Ω~120Ω |
| KNPN2S | KNPN-200-S | 4.0 | 11.5 | 0.70 | 28 | 52 | 0.024Ω~150Ω |
| KNPN2W | KNPN-200 | 5.5 | 15.5 | 0.70 | 28 | 64 | 0.043Ω~430Ω |
| KNPN3S | KNPN-300-S | 5.5 | 15.5 | 0.70 | 28 | 64 | 0.047Ω~430Ω |
| KNPN3W | KNPN-300 | 6.5 | 17.5 | 0.75 | 28 | 64 | 0.091Ω~620Ω |
| KNPN5S | KNPN-500-S | 6.5 | 17.5 | 0.75 | 28 | 64 | 0.091Ω~620Ω |
| KNPN5W | KNPN-500 | 8.5 | 24.5 | 0.75 | 38 | 90 | 0.13Ω~820Ω |
| KNPN7S | KNPN-700-S | 8.5 | 24.5 | 0.75 | 38 | 90 | |
| KNPN7W | KNPN-700 | 8.5 | 29.5 | 0.75 | 38 | B/B | |
| KNPN8S | KNPN-800-S | 8.5 | 29.5 | 0.75 | 38 | B/B | |
| KNPN8W | KNPN-800 | 8.5 | 39.5 | 0.75 | 38 | B/B | |
| KNPN9S | KNPN-900-S | 8.5 | 39.5 | 0.75 | 38 | B/B | |
| KNPN9W | KNPN-900 | 8.5 | 52.5 | 0.75 | 38 | B/B | |
| KNPNAS | KNPN-1000-S | 8.5 | 52.5 | 0.75 | 38 | B/B | |

Performance Specification(性能)

| | | |
|-------------------------|--------|---|
| Temperature coefficient | 温度系数 | ≥20 Ω: ±300PPM/°C; < 20Ω: ±400PPM/°C |
| Short-time Overload | 短时间过负荷 | ΔR/R ≤ ±(2%+0.05 Ω)Max, with no evidence of mechanical damage (无可见机械损伤) |
| Terminal strength | 端子强度 | No evidence of mechanical damage (无可见机械损伤) |
| Soldering heat | 耐焊接热 | ΔR/R ≤ ±(1%+0.05 Ω)Max, with no evidence of mechanical damage (无可见机械损伤) |
| Solderability | 可焊性 | Min.95% coverage (最少 95% 覆盖率) |
| Load life in humidity | 湿度寿命 | ΔR/R ≤ ±(5%+0.05 Ω)Max, with no evidence of mechanical damage (无可见机械损伤) |
| Load life | 负载寿命 | ΔR/R ≤ ±(5%+0.05 Ω)Max, with no evidence of mechanical damage (无可见机械损伤) |
| Resistance to solvent | 耐溶剂 | No evidence of mechanical damage (无可见机械损伤) |

Ordering Procedure (Example: KNP 3WS 5% 12Ω T/B-1000)

订购方式 (例如: KNP 3WS 5% 12Ω T/B-1000)

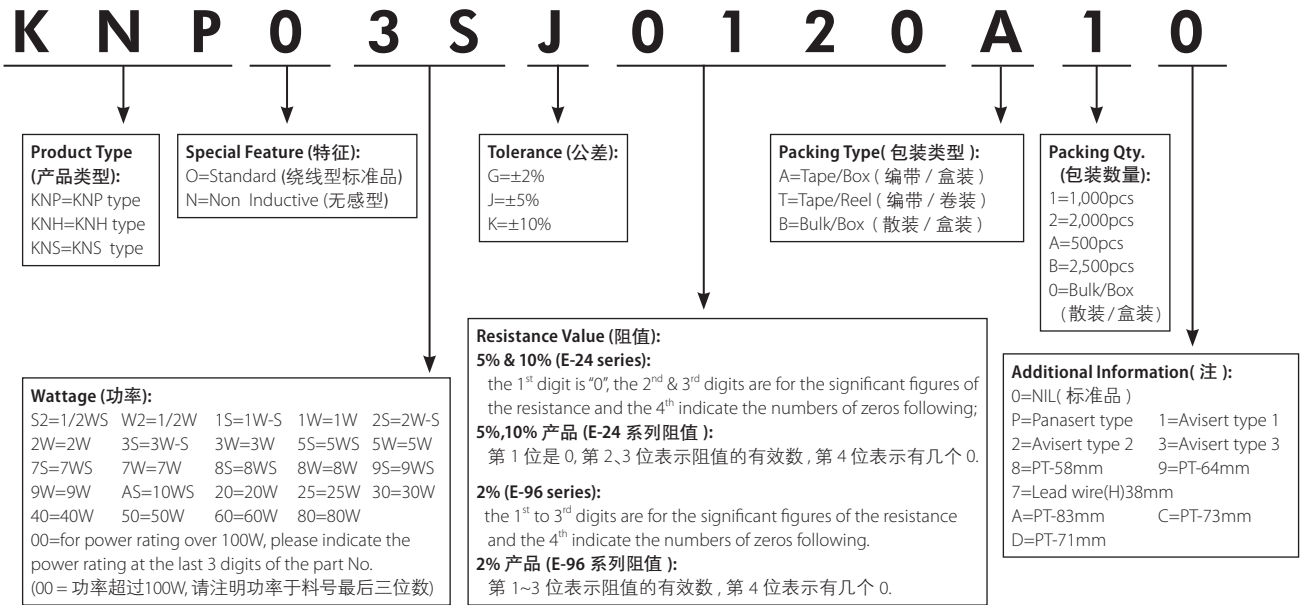

Feature (特性)

- Excellent flame retardant coating (优异不燃性涂装)
- According to IEC 61000-4-5 (符合 IEC61000-4-5 标准)
- Applies to electricity meters, home appliance and ballast (适用于电表、家电及整流器产品)



Dimension(尺寸) mm

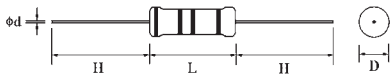

Derating Curve (降功率曲线)

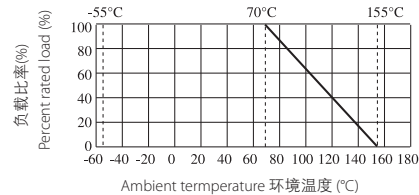

| Part No 料号 | Type 类型 | Dimension (尺寸)(mm) | | | | | Resistance Range 阻值范围 |
|---------------|----------------------|----------------------|------|--------|-----|-----|--------------------------|
| | | D±1 | L±1 | d±0.05 | H±3 | PT | |
| KNPAW2,01S | KNPA-50,KNPA-100-S | 3.5 | 9.5 | 0.54 | 28 | 52 | 10Ω~820Ω |
| KNPA1W,02S | KNPA-100,KNPA-200-S | 4.5 | 11.5 | 0.70 | 28 | 52 | 10Ω~1.2KΩ |
| KNPA2W,03S | KNPA-200,KNPA-300-S | 5.5 | 15.5 | 0.70 | 28 | 64 | 10Ω~3.0KΩ |
| KNPA3W,05S | KNPA-300,KNPA-500-S | 6.5 | 17.5 | 0.75 | 28 | 64 | 10Ω~3.9KΩ |
| KNPA5W,07S | KNPA-500,KNPA-700-S | 8.5 | 24.5 | 0.75 | 38 | 90 | 10Ω~5.6KΩ |
| KNPA7W,08S | KNPA-700,KNPA-800-S | 8.5 | 29.5 | 0.75 | 38 | B/B | 10Ω~8.2KΩ |
| KNPA8W,09S | KNPA-800,KNPA-900-S | 8.5 | 39.5 | 0.75 | 38 | B/B | 10Ω~10KΩ |
| KNPA9W,AS | KNPA-900,KNPA-1000-S | 8.5 | 52.5 | 0.75 | 38 | B/B | 10Ω~15KΩ |

Performance Specification(性能)

| | | |
|-------------------------|--------|--|
| Temperature coefficient | 温度系数 | ±200PPM/°C |
| Short-time Overload | 短时间过负荷 | ΔR/R±(2%+0.05Ω)MAX, with no evidence of mechanical damage (无可见机械损伤) |
| Terminal strength | 端子强度 | No evidence of mechanical damage (无可见机械损伤) |
| Soldering heat | 耐焊接热 | ΔR/R±(1%+0.05Ω) MAX, with no evidence of mechanical damage (无可见机械损伤) |
| Solderability | 可焊性 | Min.95% coverage (最少 95% 覆盖率) |
| Temperature cycling | 温度循环 | ΔR/R±(2%+0.05Ω) MAX, with no evidence of mechanical damage (无可见机械损伤) |
| Load life in humidity | 湿度寿命 | ΔR/R±(5%+0.05Ω) MAX, with no evidence of mechanical damage (无可见机械损伤) |
| Load life | 负载寿命 | ΔR/R±(5%+0.05Ω) MAX, with no evidence of mechanical damage (无可见机械损伤) |
| Surge Immunity | 脉冲测试 | ΔR/R±(5%+0.05Ω) MAX, with no evidence of mechanical damage (无可见机械损伤) |
| Resistance to solvent | 耐溶剂 | No evidence of mechanical damage (无可见机械损伤) |

Surge Rating(脉冲标准)

| Type 类型 | Low Resistance Range 低阻值范围 | Maximum Surge Voltage 最大脉冲电压 | Medium Resistance Range 中阻值范围 | Maximum Surge Voltage 最大脉冲电压 | High Resistance Range 高阻值范围 | Maximum Surge Voltage 最大脉冲电压 |
|--------------|----------------------------------|------------------------------------|-------------------------------------|------------------------------------|-----------------------------------|------------------------------------|
| KNPA1/2W、1WS | 10Ω~40Ω | 2KV | 43Ω~240Ω | 3KV | 270Ω~820Ω | 4KV |
| KNPA1W、2WS | 10Ω~50Ω | 3KV | 51Ω~240Ω | 4KV | 270Ω~1.2KΩ | 5KV |
| KNPA2W、3WS | 10Ω~100Ω | 4KV | 110Ω~240Ω | 5KV | 270Ω~3.0KΩ | 6KV |
| KNPA3W、5WS | 10Ω~100Ω | 6KV | 110Ω~680Ω | 7KV | 750Ω~3.9KΩ | 8KV |
| KNPA5W、7WS | 10Ω~160Ω | 7KV | 180Ω~680Ω | 8KV | 750Ω~5.6KΩ | 9KV |
| KNPA7W、8WS | 10Ω~160Ω | 8KV | 180Ω~680Ω | 9KV | 750Ω~8.2KΩ | 10KV |
| KNPA8W、9WS | 10Ω~160Ω | 9KV | 180Ω~680Ω | 10KV | 750Ω~10KΩ | 10KV |
| KNPA9W、10WS | 10Ω~160Ω | 10KV | 180Ω~680Ω | 10KV | 750KΩ~15KΩ | 10KV |

Ordering Procedure (Example: KNPA 3WS 5% 12Ω T/B-1000)

订购方式 (例如: KNPA3WS 5% 12Ω T/B-1000)

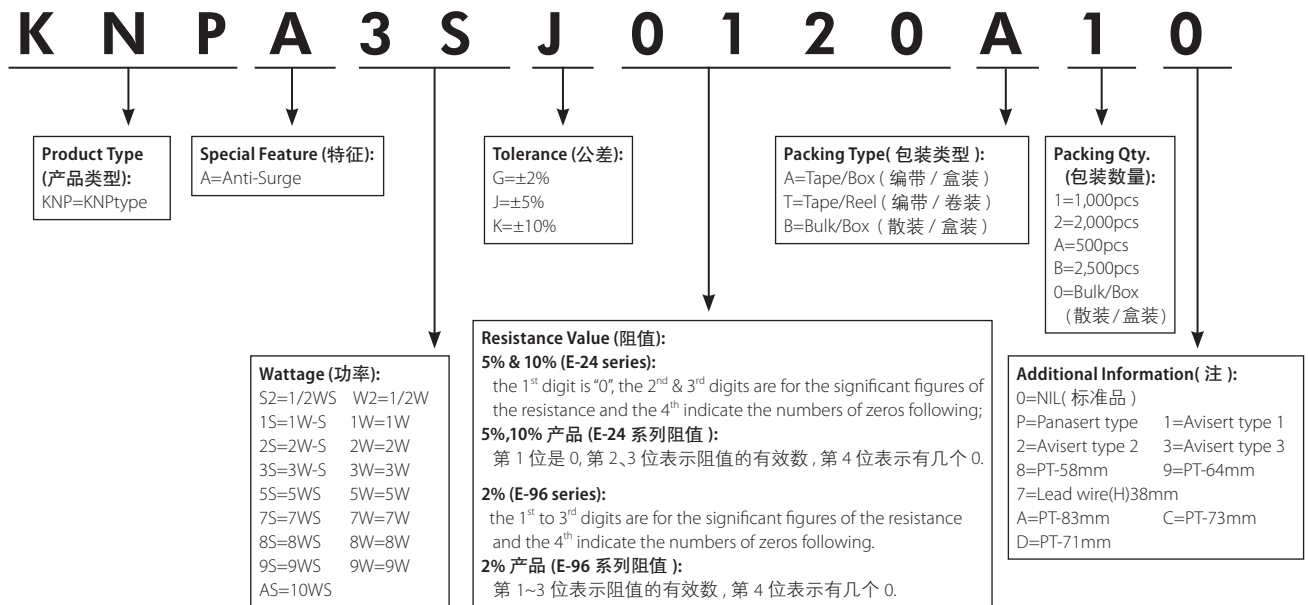

New/Old Part.no Contrast (新旧料号对照)

| New Part.no 新料号 | Old Part.no 旧料号 |
|-----------------|-----------------|
| KNPA**J***** | KSR0**J***** |

Feature (特性)

- Suitable for all kinds of protection circuit 适用各种保护电路
- Non-flammable coating, could withstand High Temperature 优异不燃性涂装, 耐高温
- Common resistor with additional safety function, no flame or smoke, no explosion or coating crack when fusing 常见的电阻器具有额外的安全性能, 无火焰或烟, 无爆炸或涂层裂纹
- UL items available (File NO:E306074) 产品 UL 安规认证 (认证号: E306074)



Dimension(尺寸) mm

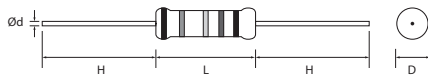

Derating Curve (降功率曲线)

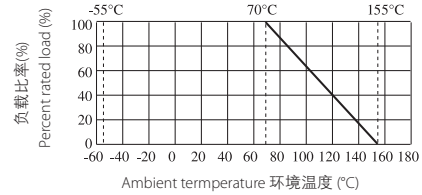

| Part No 料号 | Type 类型 | Power Rating 功率 70 °C | Dimension (尺寸)(mm) | | | | | Resistance Range 阻值范围 |
|---------------|------------|--------------------------|--------------------|--------|-----|--------|-----|--------------------------|
| | | | D(Max) | L(Max) | H±3 | d±0.05 | PT | |
| KNPU1U | KNPU1W-SS | 1W-SS | 3.0 | 8.5 | 28 | 0.54 | 52 | 10Ω |
| KNPU1S | KNPU1W-S | 1W-S | 4.3 | 9.0 | 28 | 0.60 | 52 | 0.47Ω~240Ω |
| KNPU1S | KNPU1W-S | 1W-S | 4.3 | 10.0 | 28 | 0.75 | 52 | 0.47Ω~240Ω |
| KNPU1W | KNPU100 | 1W | 5.0 | 12.0 | 28 | 0.70 | 52 | 0.47Ω~240Ω |
| KNPU2S | KNPU2W-S | 2W-S | 5.0 | 12.0 | 28 | 0.70 | 52 | 0.47Ω~240Ω |
| KNPU2W | KNPU200 | 2W | 5.5 | 16.0 | 28 | 0.70 | 64 | 0.47Ω~240Ω |
| KNPU3S | KNPU3W-S | 3W-S | 5.5 | 16.0 | 28 | 0.70 | 64 | 0.47Ω~240Ω |
| KNPU3W | KNPU300 | 3W | 6.5 | 17.5 | 28 | 0.75 | 64 | 0.47Ω~240Ω |
| KNPU5W | KNPU500 | 5W | 8.0 | 20.0 | 38 | 0.75 | B/B | 0.47Ω~240Ω |
| KNPU7W | KNPU700 | 7W | 8.5 | 25.0 | 38 | 0.75 | B/B | 0.47Ω~47Ω |

Performance Specification(性能)

| | | |
|---------------------------------|--------|---|
| Temperature coefficient | 温度系数 | ≥20 Ω: ±300PPM/°C <20 Ω: ±400PPM/°C |
| Short-time Overload | 短时间过负荷 | ΔR/R ≤±(2%±0.05Ω), with no evidence of mechanical damage (无可见机械损伤) |
| Dielectric withstanding voltage | 绝缘耐压 | No evidence of flashover, mechanical damage.(500V). 无击穿、飞弧及可见机械损伤 (500V) |
| Terminal strength | 端子强度 | No evidence of mechanical damage (无可见机械损伤) |
| Soldering heat | 耐焊接热 | ΔR/R ≤±(1%±0.05Ω), with no evidence of mechanical damage (无可见机械损伤) |
| Solderability | 可焊性 | Min. 95% coverage (最小 95% 覆盖率) |
| Load life in humidity | 湿度寿命 | ΔR/R ≤±(5%±0.05Ω), with no evidence of mechanical damage (无可见机械损伤) |
| Load life | 负载寿命 | ΔR/R ≤±(5%±0.05Ω), with no evidence of mechanical damage (无可见机械损伤) |

Ordering Procedure (Example: KNPU 3WS 5% 12Ω T/B-1000)

订购方式 (例如: KNPU3WS 5% 12Ω T/B-1000)

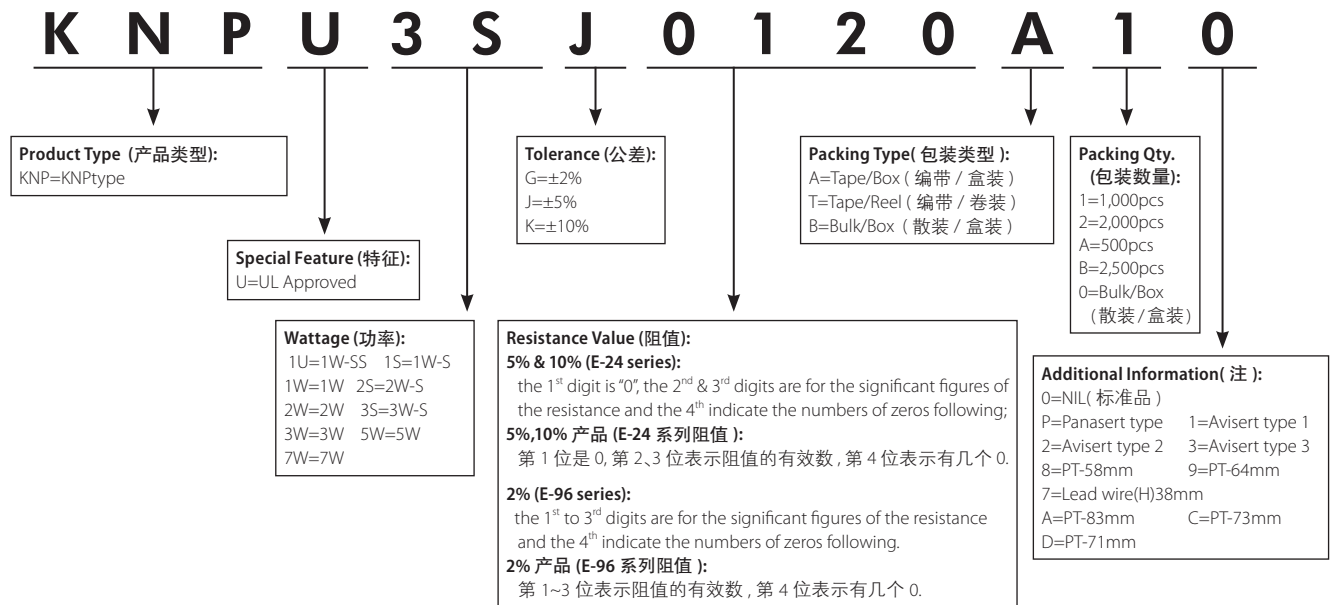

Feature (特性)

- Small body size 体积小
- High power 功率大
- Excellent flame retardant coating 优异的阻燃封装
- Provides stable performance in various environments 在各种环境中提供优异的稳定性



Dimension(尺寸) mm

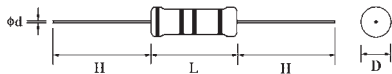

Derating Curve (降功率曲线)

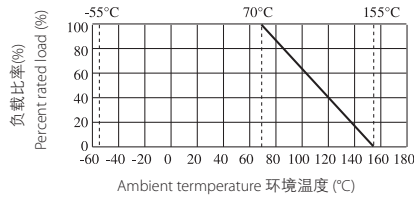

Surge Withstanding Curve (脉冲曲线)

100ms Single Pulse Power-Value Chart (100ms 单脉冲曲线)

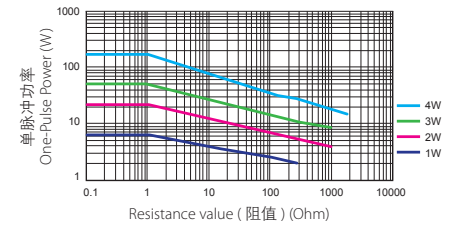

| Part No 料号 | Type 类型 | Power Rating 功率 70°C | Dimension (尺寸)(mm) | | | | Max Working Voltage 最大工作电压 | Dielectric Withstand Voltage 绝缘耐压 | Resistance Range 阻值范围 |
|---------------|-------------|----------------------------|--------------------|------|--------|-----|-------------------------------|--------------------------------------|-----------------------------|
| | | | D±1 | L±1 | d±0.05 | H±3 | | | |
| WPR01W | WPR-100 | 1W | 2.5 | 6.2 | 0.60 | 28 | 50V | 250V | 0.1Ω~300Ω |
| WPR02W | WPR-200 | 2W | 3.5 | 9.0 | 0.75 | 28 | 50V | 250V | 0.1Ω~1KΩ |
| WPR03W | WPR-300 | 3W | 4.5 | 10.5 | 0.75 | 28 | 50V | 350V | 0.1Ω~1KΩ |
| WPR04W | WPR-400 | 4W | 5.5 | 15.5 | 0.75 | 28 | 50V | 350V | 0.1Ω~1.8KΩ |
| WPR0AU | WPR-1000-SS | 10W-SS | 8.5 | 39.5 | 0.75 | 38 | 50V | 350V | 1Ω~5KΩ |

Performance Specification(性能)

| | | |
|-------------------------|--------|---|
| Temperature coefficient | 温度系数 | ±200PPM/°C |
| Short-time Overload | 短时间过负荷 | ΔR/R ≤ ±(5.0%+0.05Ω) Max. with no evidence of mechanical damage (无可见机械损伤) |
| Terminal strength | 端子强度 | No evidence of mechanical damage (无可见机械损伤) |
| Soldering heat | 耐焊接热 | ΔR/R ≤ ±(1.0%+0.05Ω) Max. with no evidence of mechanical damage (无可见机械损伤) |
| Solderability | 可焊性 | Min. 95% coverage (最少 95% 覆盖率) |
| Temperature cycling | 温度循环 | ΔR/R ≤ ±(2.0%+0.05Ω) Max. with no evidence of mechanical damage (无可见机械损伤) |
| Humidity (Steady State) | 恒定湿热 | ΔR/R ≤ ±(2.0%+0.05Ω) Max. with no evidence of mechanical damage (无可见机械损伤) |
| Pulse test | 脉冲测试 | ΔR/R ≤ ±(5.0%+0.05Ω) Max. with no evidence of mechanical damage (无可见机械损伤) |
| Resistance to solvent | 耐溶剂 | No deterioration of protective coating and markings (包封层, 色码完整) |
| Load life in humidity | 湿度寿命 | ΔR/R ≤ ±(5.0%+0.05Ω) Max. with no evidence of mechanical damage (无可见机械损伤) |
| Load life | 负载寿命 | ΔR/R ≤ ±(5.0%+0.05Ω) Max. with no evidence of mechanical damage (无可见机械损伤) |

Ordering Procedure (Example: WPR1W 5% 100Ω T/B-1000)

订购方式 (例如: WPR1W 5% 100Ω T/B-1000)

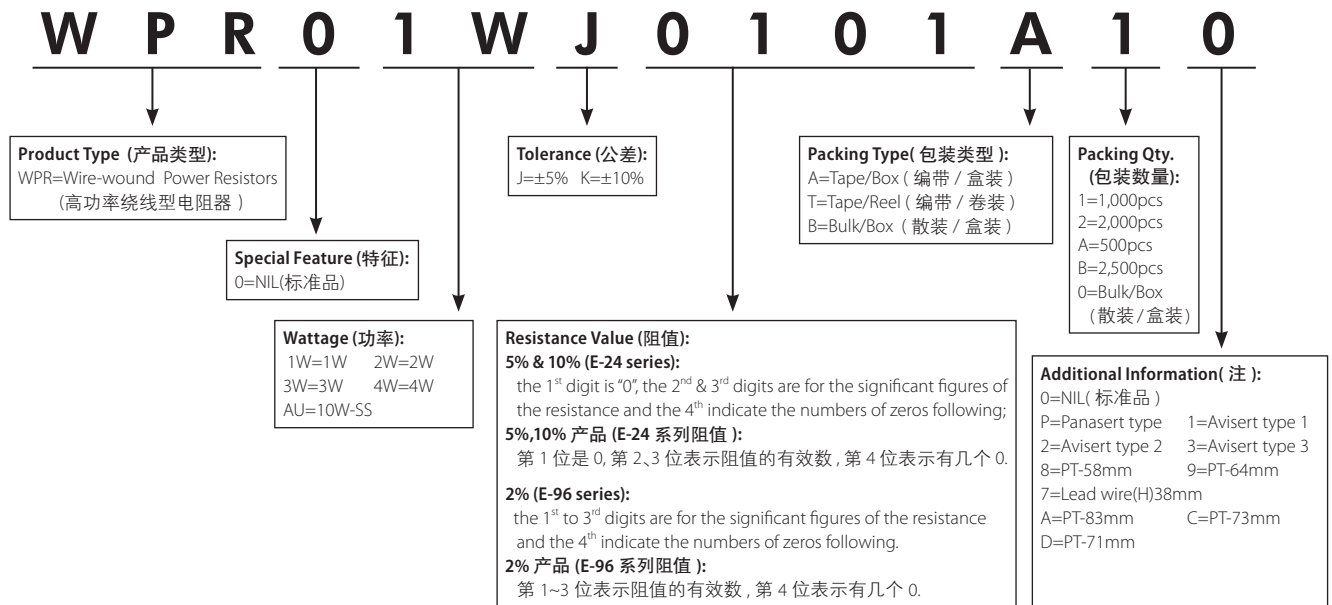

New/Old Part.no Contrast (新旧料号对照)

| New Part.no 新料号 | Old Part.no 旧料号 |
|-----------------|-----------------|
| WPR01W****A*0 | KNP01UJ****A*0 |
| WPR02W****A*0 | KNP02UJ****A*0 |
| WPR03W****A*0 | KNP03UJ****A*0 |
| WPR04W****A*0 | KNP04UJ****A*0 |
| WPR0AU****A*0 | KNP0AUJ****A*0 |

Feature (特性)

- Low resistance value with higher power dissipation 低阻值高功耗
- Wire-wound resistor with thermal fuse protection 绕线电阻热熔断保护
- Used in Electronic ballast, other lighting applications
一般用在电子整流器及其它照明用途



Dimension(尺寸) mm

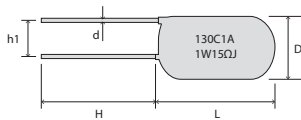

Derating Curve (降功率曲线)

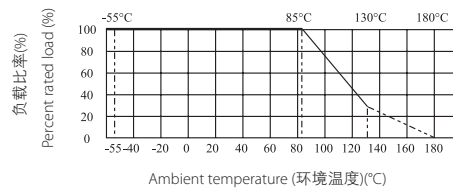

| Type 类型 | Power Rating 功率 70°C | Dimension (尺寸)(mm) | | | | | | | | | | Resistance Range 阻值范围 | |
|---------|----------------------|-----------------------------------|---------|---------|----------|--------|----------------|---------|------------|---------|----|-----------------------|----------|
| | | D | L | H (Min) | h1 (Min) | d±0.02 | Current Rating | TF (°C) | TH/TC (°C) | TM (°C) | Ir | | Ur |
| TFR | 1W | 5.5±0.5 | 14±1 | 12 | 3.5 | 0.53 | 2A | 130 | 102 | 180 | 2 | 250 | 2.2~4.7Ω |
| TFR | 1W | 5.5 ⁺¹ _{-0.5} | 11(Max) | 12 | 3.5 | 0.53 | 1A | 130 | 102 | 180 | 1 | 250 | 2.2~4.7Ω |

Ordering Procedure (Example: TFR1W 5% 4.7Ω B/B)

订购方式 (例如: TFR1W 5% 4.7Ω B/B)

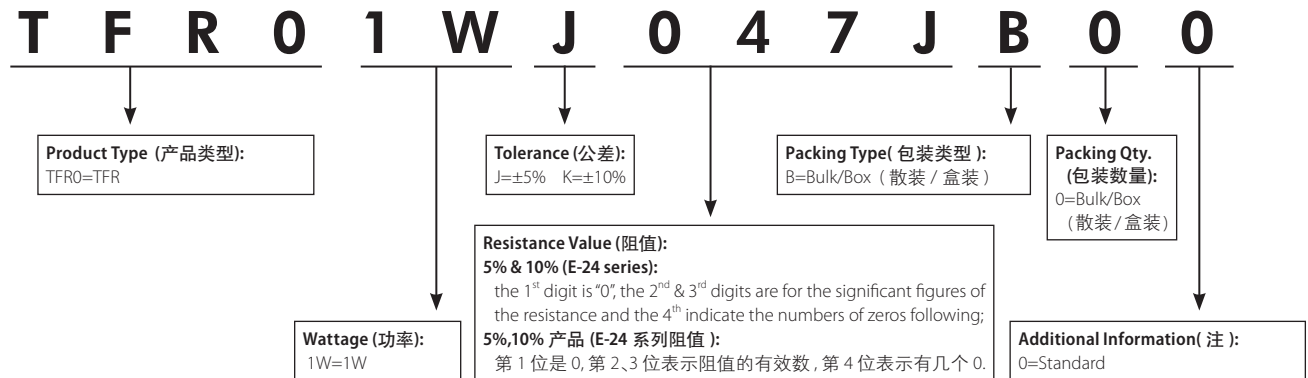

ZW Type (ZW 型)

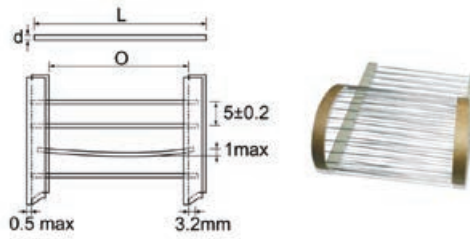

| Part No 料号 | Type 类型 | L±3 | d±0.05 | O±1 | |
|------------|---------|-------|--------|-----|----|
| ZWA0 | ZW-A | 60/34 | 0.45 | 52 | 26 |
| ZWB0 | ZW-B | 60/34 | 0.54 | 52 | 26 |
| ZWB-1 | ZW-B1 | 60/34 | 0.60 | 52 | 26 |
| ZWC0 | ZW-C | 60/34 | 0.70 | 52 | 26 |
| ZWD0 | ZW-D | 60/34 | 0.75 | 52 | 26 |
| ZWE0 | ZW-E | 60/34 | 1.00 | 52 | 26 |

ZO Type (ZO 型)

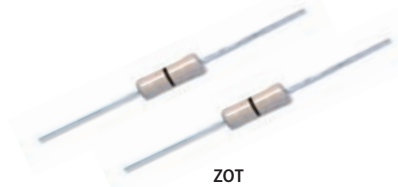
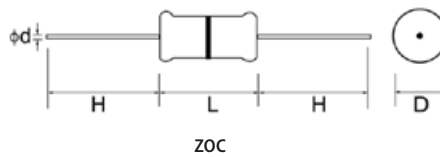

| Part No 料号 | Type | Power Rating 功率 70°C | Dimension (尺寸)(mm) | | | | Resistance Range 阻值范围 (≤mΩ) |
|---------------|-------|----------------------|--------------------|---------|--------|-----|-----------------------------|
| | | | D±0.3 | L | d±0.05 | H±3 | |
| ZOT0W8/ZOC0W8 | ZO-12 | 1/8W | 1.9 | 3.3±0.3 | 0.45 | 28 | ZOT: 10 ZOC: 50 |
| ZOT0W4/ZOC0W4 | ZO-25 | 1/4W | 2.2 | 6.5±1.0 | 0.54 | 28 | |

Performance Specification(性能)

| | |
|--------------------------------------|---|
| Lead material 引线材料 | Tin-Plated copper (镀锡铜线) |
| Insulation resistance 绝缘阻值 | Dry(干态)-10,000MΩ,Wet(湿态)-100MΩ |
| Dielectric withstanding voltage 绝缘耐压 | Atmospheric (正常气压)-500V RMS; Reduced (减压)-325VRMS; |
| Rated current 额定电流 | 1/8W70°C 1.5A, 1/4W 70°C 2.5A Derating to 0 Amps at 150°C 1/8W70°C 1.5A, 1/4W 70°C 2.5A 150°C时, 电流降低到 0A |

Ordering Procedure (Example: ZOC 1/4W 0Ω T/R-5000)

订购方式(例如: ZOC 1/4W 0Ω T/R-5000)

Z O C 0 W 4 0 0 0 0 0 T 5 0

Product Type (产品类型):
Zero Ohm Resistors(0Ω电阻)
ZOT0=0Ω(铁棒涂漆0Ω电阻)
ZOC0=0Ω(镀铜瓷棒0Ω电阻)
Jumper Wire(跳线):
ZWA0=0.45mm ZWB0=0.54mm
ZWB1=0.60mm ZWC0=0.70mm
ZWD0=0.75mm ZWE0=1.0mm

Wattage (功率):
Zero Ohm Resistors(0Ω电阻)
W8=1/8W
W4=1/4W
Jumper Wire(跳线):
00=NIL

Tolerance (公差):
0=NIL

Packing Type(包装类型):
A=Tape/Box (编带/盒装)
T=Tape/Reel (编带/卷装)
B=Bulk/Box (散装/盒装)
P=Tape/Box of PT-26 product
编带/(PT-26产品)盒装

Packing Qty. (包装数量):
5=5,000pcs
7=7,000pcs
8=8,000pcs
C=10,000pcs
0=Bulk/Box (散装/盒装)

Resistance Value (阻值):
Fill-in these 4digits with "0" specially 填4个0表示0阻值

Additional Information(注):
0=NIL(标准品)

New/Old Part.no Contrast (新旧料号对照)

| New Part.no 新料号 | Old Part.no 旧料号 | New Part.no 新料号 | Old Part.no 旧料号 |
|-----------------|-----------------|-----------------|-----------------|
| ZOC0**00000A*0 | CFR0**00000A*0 | ZWB10000000A*0 | ZWF00000000A*0 |
| ZOT0**00000A*0 | ZO00**00000A*0 | ZWE00000000A*0 | ZWF00000000A*0 |

Copper Plated Steel Wire [铜包钢 (CP型)]

Tin Plated Copper Steel Lead Wire [镀锡铜包钢 (CT型)]

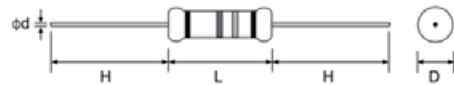

| Part No 料号 | Type 类型 | Power Rating 功率 70°C | Dimension (尺寸)(mm) | | | | MAX.Working Voltage 最大工作 电压 | MAX.Overload Voltage 最大过负荷 电压 | Dielectric Withstanding Voltage 绝缘耐压 | Resistance Range 阻值范围 |
|---------------|------------|-------------------------|--------------------|---------|--------|-------|--------------------------------------|--|---|-----------------------------|
| | | | D | L | d±0.05 | H±3 | | | | |
| CPXXW8/CTXXW8 | CP/CT12 | 1/8W | 1.9±0.3 | 3.3±0.3 | 0.54 | 28 | 200V | 400V | 400V | 1Ω~10MΩ |
| CPXXW4/CTXXW4 | CP/CT25 | 1/4W | 2.2±0.5 | 6.5±1.0 | 0.54 | 28/38 | 250V | 500V | 500V | 1Ω~10MΩ |
| CPXXS3/CTXXS3 | CP/CT33-S | 1/3W-S | 2.2±0.5 | 6.5±1.0 | 0.54 | 28/38 | 300V | 600V | 500V | 1Ω~10MΩ |
| CPXXW3/CTXXW3 | CP/CT33 | 1/3W | 3±0.5 | 9.0±1.0 | 0.54 | 28 | 300V | 600V | 700V | 1Ω~10MΩ |
| CPXXS2/CTXXS2 | CP/CT50-S | 1/2W-S | 3±0.5 | 9.0±1.0 | 0.54 | 28 | 350V | 700V | 700V | 1Ω~10MΩ |

Cutting Type (CO) [切割半成品型 (CO) 型]



| Part No. 料号 | Type 类型 | Power Rating 功率 70°C | Dimension (尺寸)(mm) | | Resistance Range 阻值范围 |
|----------------|------------|----------------------------|---------------------------------------|---------------------------------------|--------------------------|
| | | | D | L | |
| CO...W8 | CO-12 | 1/8W | 1.6 ^{+0.10} _{-0.00} | 3.2 ±0.10 | 1Ω ~ 10MΩ |
| CO...W4 | CO-25 | 1/4W | 2.1 ^{+0.09} _{-0.00} | 5.6 ^{+0.10} _{-0.20} | 1Ω ~ 10MΩ |
| CO...W4...A | CO-25-A | 1/4W | 2.1 ^{+0.09} _{-0.00} | 5.9 ^{+0.10} _{-0.15} | 1Ω ~ 10MΩ |
| CO...W4...B | CO-25-B | 1/4W | 2.1 ^{+0.09} _{-0.01} | 6.4 ^{+0.10} _{-0.15} | 1Ω ~ 10MΩ |

• Cutting type resistors are produced without lead-wire and without coating
切割型半成品型电阻无导线，无涂漆

• Cap plated option: 1. Tin-plated 2. Nickel-Plated
铁帽：1 镀锡 2 镀镍

Ordering Procedure (Example: CTO 1/4W 5% 10Ω T/B-5000, CTO lead wire)

订购方式 (例如: CTO 1/4W 5% 10Ω T/B-5000, CTO导线)

C T O O W 4 J 0 1 0 0 A 5 0

Special Feature (特征):
O=Standard(标准品)
F=Flame Retardant (阻燃型)
I=Non-Inductive (无感型)

Product Type (产品类型):
CPO=Copper plated steel lead wire
铜包钢线 (H=28mm)
CPL=Copper plated steel lead wire
铜包钢线 (H=38mm)
CTO= Tin Plated copper lead wire
镀锡铜包钢线 (H=28mm)
CTL= Tin Plated copper steel lead wire
镀锡铜包钢线 (H=38mm)
COT= Cutting type (Tin-Plated Cap)
[切割型 (镀锡铁帽)]
CON= Cutting type (Nickel-Plated Cap)
[切割型 (镀镍铁帽)]

Wattage (功率):
W8=1/8W
W4=1/4W
W3=1/3W
S3=1/3WS
S2=1/2WS

Tolerance (公差):
G = ±2%
J = ±5%
K = ±10%

Resistance Value (阻值):
5% & 10% (E-24 series):
the 1st digit is '0', the 2nd & 3rd digits are for the significant figures of the resistance and the 4th indicate the numbers of zeros following;
5%,10% 产品 (E-24 系列阻值):
第 1 位是 0, 第 2、3 位表示阻值的有效数, 第 4 位表示有几个 0.
2% (E-96 series):
the 1st to 3rd digits are for the significant figures of the resistance and the 4th indicate the numbers of zeros following.
2% 产品 (E-96 系列阻值):
第 1~3 位表示阻值的有效数, 第 4 位表示有几个 0.

Packing Type (包装类型):
A=Tape/Box (编带 / 盒装)
T=Tape/Reel (编带 / 卷装)
B=Bulk/Box (散装 / 盒装)
P=Tape/Box of PT-26 product
编带 (PT-26 产品) / 盒装

Packing Qty. (包装数量):
1=1,000pcs
2=2,000pcs
3=3,000pcs
4=4,000pcs
5=5,000pcs
A=500pcs
B=2,500pcs
0=Bulk/Box
(散装 / 盒装)

Additional Information (注):
0=CP/CT Type
A=Co-25-A,
B=CO-25-B

Feature (特性)

- This specification is applicable for CFR 1/4W,1/2W,1WS&CPR1/2W&MF1/4W,1/2WS,1/2W,1WS,2WS&MOR1/4W,1WS,2WS, KNP1/4W,1/2WS,1WS,2WS product only. KNP2WS product only; For other product (size), please consult factory for the available specification and drawing.

下图规格适用于 CFR1/4W,1/2W,1WS&CPR1/2W&MF1/4W,1/2WS,1/2W,1WS,2WS&MOR1/4W,1WS,2WS,KNP1/4W,1/2WS,1WS,2WS. 其它产品的立式加工, 可洽询工厂以取得可生产的规格图样。

- Standard product is insulated lead wire, insulated coating length 1/4W: 9.5±1mm; 1WS:13±1mm; 2WS:15±1mm
标准品为绝缘引线, 绝缘涂层长度为: 1/4W: 9.5±1mm; 1WS: 13±1mm; 2WS: 15±1mm

Panasert Type 1:

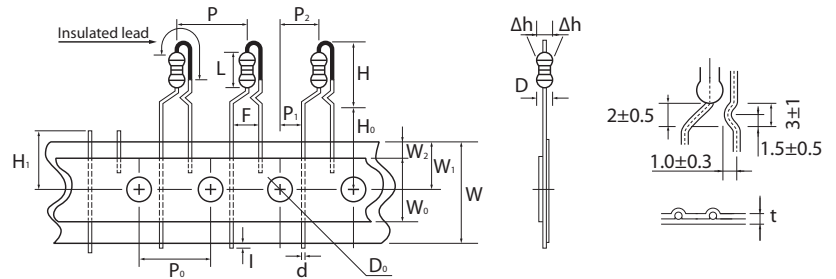

Panasert Type 1:

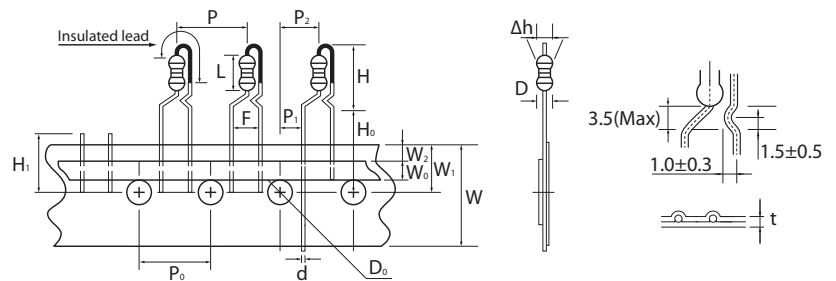

Panasert Type 2:

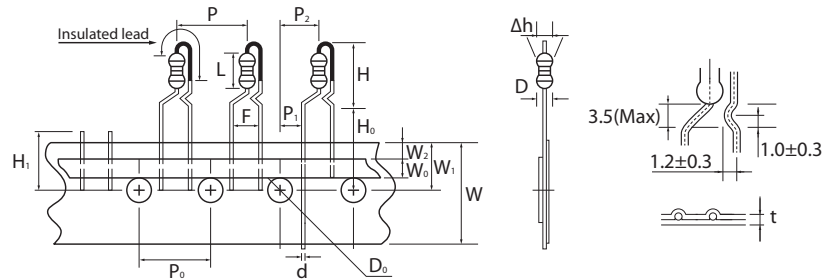

| Items(项目) | Symbol | Dimension 尺寸 (mm) | | | |
|-----------------------------------|--------------------------------|-----------------------|-------------|---------------------|---------------------|
| | | 1/4W | 1/2WS | 1WS | 2WS |
| Body diameter 本体直径 | D | 2.5 (Max) | 3±0.5 | 3.5±0.5 | 4±0.5 |
| Body length 本体长度 | L | 6.8 (Max) | 9±1 | 9±1 | 11.5±1 |
| Body height 本体高度 | H | 12 (Max) | 17 (Max) | 19 (Max) | 21 (Max) |
| Lead-wire diameter 导线直径 | d | 0.60±0.05 | 0.60±0.05 | 0.70±0.05 | 0.70±0.05 |
| Pitch of component 零件间距 | p | 12.7±1 | 12.7±1 | 12.7±1 | 12.7±1 |
| Feed hole pitch 孔距 | P ₀ | 12.7±0.3 | 12.7±0.3 | 12.7±0.3 | 12.7±0.3 |
| Hole center to lead 中心测量 | P ₁ | 3.85±0.7 | 3.85±0.7 | 3.85±0.7 | 3.85±0.7 |
| Hole center to body 孔心至本体 | P ₂ | 6.35±1.3 | 6.35±1.3 | 6.35±1.3 | 6.35±1.3 |
| Lead to lead distance 两脚导线中心测量 | F | 5±1 | 5±1 | 5±1 | 5±1 |
| Component alignment 零件偏移 | Δh | 0±1 | 0±1 | 0±1 | 0±1 |
| Tape width 纸带宽度 | W | 18±1 | 18+1/-1.5 | 18+1/-1.5 | 18+1/-1.5 |
| Sticky tape width 热熔胶带宽 | W ₀ | 12.5 (Min) 6 (min) | / 6±0.2 | 12.5 (Min) 6±0.2 | 12.5 (Min) 6±0.2 |
| Hole position 孔位 | W ₁ | 9±0.5 | 9+0.75/-0.5 | 9+0.75/-0.5 | 9+0.75/-0.5 |
| Uncovered paper tape width 纸带露出宽度 | W ₂ | 1.5 (Max) | 1.5 (Max) | 1.5 (Max) | 1.5 (Max) |
| Lead-wire clinch height 导线固定高度 | H ₀ | 16.5 (Max) | 16±0.5 | 16±0.5 | 16±0.5 |
| Length of snipped lead 导线剪断高度 | H ₁ | 11 (Max) | 11 (Max) | 11 (Max) | 11 (Max) |
| Feed hole diameter 孔径 | D ₀ | 4±0.3 | 4±0.3 | 4±0.3 | 4±0.3 |
| Total tape thickness 胶带厚度 | t | 0.5±0.2 | 0.5±0.2 | 0.5±0.2 | 0.5±0.2 |
| Lead wire protrusion 导线露出 | i | 1Max | - | - | - |
| Length of lead cut 切脚的长度 | H ₁ -w ₁ | 2±0.5 | 2±0.5 | 2±0.5 | 2±0.5 |

Avisert(1) Type 【Avisert(1)型】

- This specification is applicable for CFR1/4W,CPR1/2W&MF1/4W,1/2WS,0.6WS,MOR1/4W,1/2WS,product only; For other product (size), please consult factory for the specification and drawing.
适用于 CFR1/4W, CPR1/2W & MF1/4W, 1/2WS, 0.6WS, MOR1/4W, 1/2WS 固定电阻。其它产品的立式加工，可洽询工厂以取得可生产的规格图样。
- Standard product is insulated lead wire,insulated coating length 9.5±1mm
标准为绝缘引线，绝缘涂层长度为：9.5±1mm。

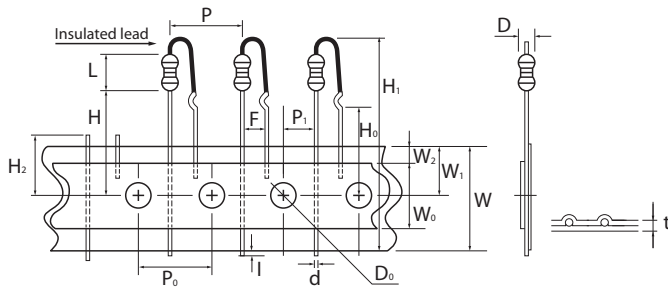

Avisert(2) Type 【Avisert(2)型】

- This specification is applicable for CFR1/8W, 1/4WS&MF1/8W, 1/4WS product only; For other product available forming products, please consult factory for the specification and drawing.
适用于 CFR1/8W, 1/4WS&MF1/8W, 1/4WS 固定电阻。其它产品的立式加工，可洽询工厂以取得可生产的规格图样。

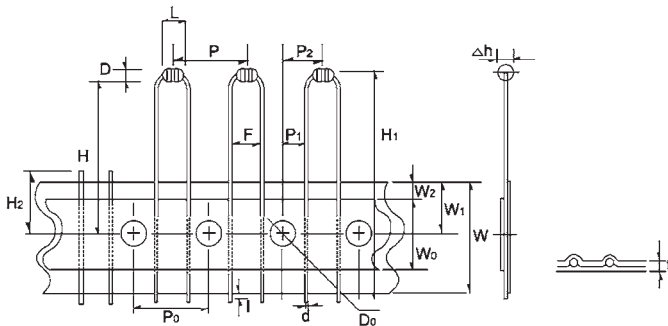

| Items (项目) | Symbol | Dimension 尺寸 (mm) |
|---|--------|-----------------------|
| | | 1/4W |
| Body diameter 本体直径 | D | 2.5 (Max) |
| Body length 本体长度 | L | 6.8 (Max) |
| Lead-wire diameter 导线直径 | d | 0.60±0.05 |
| Pitch of component 零件间距 | p | 12.7±1 |
| Feed hole pitch 孔距 | P0 | 12.7±0.3 |
| Hole center to lead 中心测量 | P1 | 3.85±0.7 |
| Lead to lead distance 两脚导线中心测量 | F | 5±1 |
| Tape width 纸带宽度 | W | 18±1 |
| Sticky tape width 热熔胶带宽 | W0 | 12.5 (Min) 6 (min) |
| Hole position 孔位 | W1 | 9.5±0.5 |
| Uncovered paper tape width 纸带露出宽度 | W2 | 3.0 (Max) |
| Height of component from tape center 零件至纸带中间的宽度 | H | 17.3±0.5 |
| Lead-wire clinch height 导线固定高度 | H0 | 16.5 (Max) |
| Component height 零件高度 | H1 | 34.5 (Max) |
| Length of snipped lead 导线剪断高度 | H2 | 11 (Max) |
| Feed hole diameter 孔径 | D0 | 4±0.3 |
| Total tape thickness 胶带厚度 | t | 0.5±0.2 |
| Lead wire protrusion 导线露出 | i | 1 (Max) |

| Items (项目) | Symbol | Dimension 尺寸 (mm) |
|---|--------|-------------------|
| | | 1/8W |
| Body diameter 本体直径 | D | 1.85 (Max) |
| Body length 本体长度 | L | 3.5 (Max) |
| Lead-wire diameter 导线直径 | d | 0.45±0.05 |
| Pitch of component 零件间距 | p | 12.7±1 |
| Feed hole pitch 孔距 | P0 | 12.7±0.3 |
| Hole center to lead 中心测量 | P1 | 3.85±0.7 |
| Hole center to component center 孔心至零件中心距离 | P2 | 6.35±1.3 |
| Lead to lead distance 两脚导线中心测量 | F | 5±1 |
| Tape width 纸带宽度 | W | 18±1 |
| Sticky tape width 热熔胶带宽 | W0 | 6 (Min) |
| Hole position 孔位 | W1 | 9.0±0.5 |
| Uncovered paper tape width 纸带露出宽度 | W2 | 3.0 (Max) |
| Lead wire protrusion 打弯处到纸带中心位置 | H | 21.25 (Max) |
| Component height 零件高度 | H1 | 32.25 (Max) |
| Length of snipped lead 导线剪断高度 | H2 | 11 (Max) |
| Feed hole diameter 孔径 | D0 | 4±0.3 |
| Total tape thickness 胶带厚度 | t | 0.5±0.2 |
| Lead wire protrusion 导线露出 | i | 1 (Max) |

Avisert(3) Type 【Avisert(3)型】

- This specification is applicable for CFR1/8W, CFR1/4WS, MF1/8W, MF1/4WS, MF1/4W, MF1/2WS, MF0.6WS, MOR1/4W, MOR1/2WS. For other product (size), please consult factory for the specification and drawing.
下图规格适用于 CFR1/8W,CFR1/4WS,MF1/8W,MF1/4WS,MF1/4W,MF1/2WS,MF0.6WS,MOR1/4W,MOR1/2WS; 其它产品的立式加工, 可洽询工厂以取得可生产的规格图样.
- Standard product is insulated lead wire,insulated coating length 9.5±1mm.
标准为绝缘引线, 绝缘涂层长度为: 9.5±1mm.

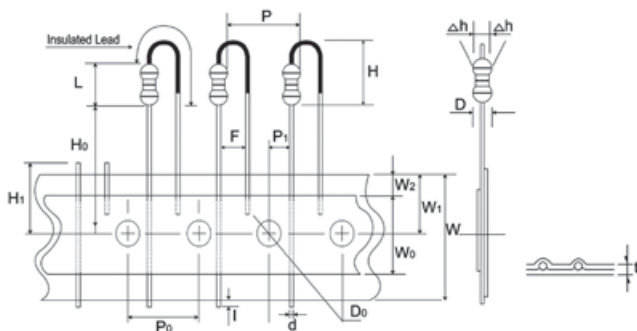

| Items (项目) | Symbol | Dimension 尺寸 (mm) | |
|-----------------------------------|--------|-------------------|------------|
| | | 1/8W | 1/4W |
| Body diameter 本体直径 | D | 2.0 (Max) | 2.5 (Max) |
| Body length 本体长度 | L | 4.2 (Max) | 6.8 (Max) |
| Lead-wire diameter 导线直径 | d | 0.45±0.05 | 0.60±0.05 |
| Pitch of component 零件间距 | p | 12.7±1 | 12.7±1 |
| Feed hole pitch 孔距 | P0 | 12.7±0.3 | 12.7±0.3 |
| Hole center to lead 中心测量 | P1 | 3.85±0.7 | 3.85±0.7 |
| Lead to lead distance 两脚导线中心测量 | F | 2.5±1 | 5±1 |
| Tape width 纸带宽度 | W | 18±1 | 18±1 |
| Sticky tape width 热熔胶带宽 | W0 | 6min | 6min |
| Hole position 孔位 | W1 | 9.0±0.5 | 9.0±0.5 |
| Uncovered paper tape width 纸带露出宽度 | W2 | 3.0 (Max) | 3.0 (Max) |
| Body height 本体高度 | H | 7.0 (Max) | 10.0 (Max) |
| Lead-wire clinch height 导线固定高度 | H0 | 20.0 (Max) | 16.0 (Max) |
| Component alignment 零件偏移 | Δh | 0±1 | 0±1 |
| Length of snipped lead 导线剪断高度 | H1 | 11 (Max) | 11 (Max) |
| Feed hole diameter 孔径 | D0 | 4±0.3 | 4±0.3 |
| Total tape thickness 胶带厚度 | t | 0.5±0.2 | 0.5±0.2 |
| Lead wire protrusion 导线露出 | i | 1 (Max) | 1 (Max) |

Ordering Procedure (Example: CFR1/4W 5% 100KΩ T/B-2000 PANASERT Type)

订购方式 (例如: CFR1/4W 5% 100KΩ T/B-2000 PANASERT Type)

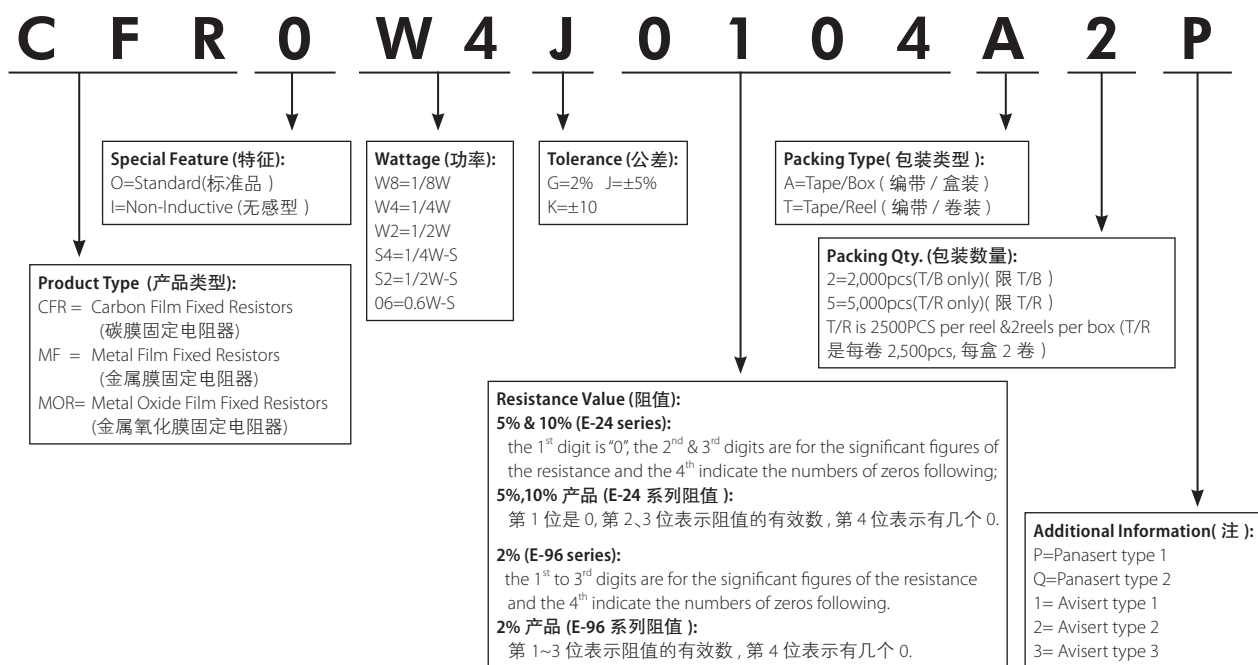

F Forming Type (F 型)

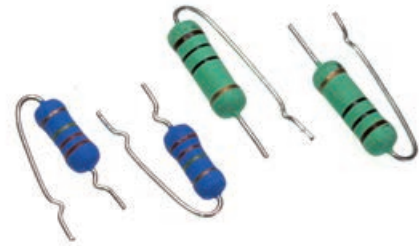
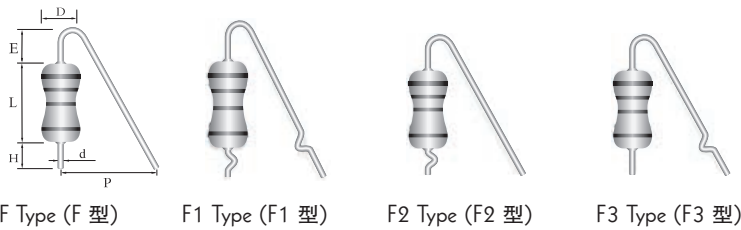

Dimension (尺寸) (mm)

| Power Rating 功率 | L Max. L 最大 | D Max. D 最大 | d ± 0.05 | P +1 -3 | H ± 1 | E ± 0.5 |
|--------------------|----------------|----------------|----------|------------|-------|---------|
| 1W (2W-S) | 12 | 5.0 | 0.70 | 8 | 6 | 2.5 |
| 2W (3W-S) | 16 | 5.5 | 0.70 | 8 | 6 | 2.5 |

M Forming Type (M 型)

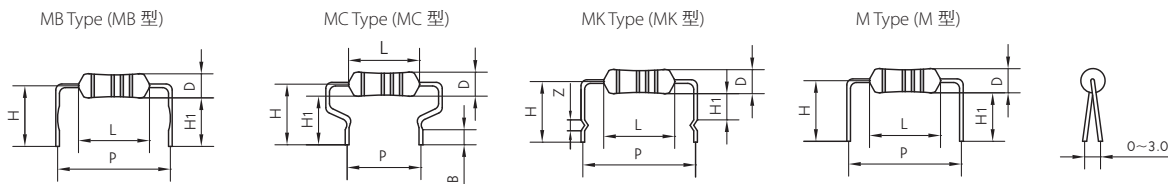

| Power Rating 功率 70°C | L(Max) | D(Max) | d ± 0.05 | H ± 2 | P ± 1.5 |
|-------------------------|--------|--------|----------|-------|---------|
| 1/2W & 1WS | 10 | 4 | 0.70 | 14 | 13 |
| 1W & 2WS | 12 | 5 | 0.70 | 14 | 15 |
| 2W & 3W-S | 16 | 5.5 | 0.70 | 18 | 20 |
| 3W & 5WS | 17.5 | 6.5 | 0.75 | 20 | 25 |
| 5W | 26 | 8.5 | 0.75 | 20 | 31 |

T Forming Type (T 型)

| Power Rating 功率 70°C | L(Max) | D(Max) | d ± 0.05 | P(Max) | H +1 -0 |
|-------------------------|--------|--------|----------|--------|------------|
| 1W-S | 10 | 3.5 | 0.70 | 12.5 | 8 |
| 1W(2W-S) | 12 | 5.0 | 0.70 | 15 | 8 |
| 2W(3W-S) | 16 | 5.5 | 0.70 | 20 | 9 |

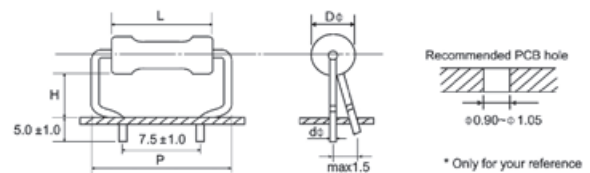

Ordering Procedure (Example: MOR1WS 5% 10Ω B/B M Type with flattened lead wire)

订购方式 (例如: MOR1WS 5% 10Ω B/B M 型导线打扁)

M O R 0 1 S J 0 1 0 0 B M F

Special Feature (特征):
O=Standard(标准品)
I=Non-Inductive(无感型)

Wattage (功率):
W2=1/2W 1W=1W
2W=2W 3W=3W
5W=5W 1S=1W-S
2S=2W-S 3S=3W-S
5W=5W-S

Tolerance (公差):
G=2% J=±5% K=±10

Packing Type (包装类型):
B=Bulk/Box (散装/盒装)

Additional Information (注):
F0=F Type (F 型) F1=F1 Type (F1 型)
F2=F2Type (F2 型) F3=F3 Type (F3 型)
T0=T Type (T 型)
MF=M Type with flattened lead wire
M 型导线打扁
MC=M Type with bending lead wire
M 型导线打弯曲
MK=M Type with kinked lead wire
M 型导线打弯折
ML=M Type with normal lead wire
M 型导线直线

Product Type (产品类型):
MOR=Metal Oxide Film Fixed Resistors
(金属氧化膜固定电阻器)
CFR=Carbon Film Fixed Resistors
(碳膜固定电阻器)

Resistance Value (阻值):
5% & 10% (E-24 series):
the 1st digit is "0", the 2nd & 3rd digits are for the significant figures of the resistance and the 4th indicate the numbers of zeros following;
5%,10% 产品 (E-24 系列阻值):
第 1 位是 0, 第 2、3 位表示阻值的有效数, 第 4 位表示有几个 0.
2% (E-96 series):
the 1st to 3rd digits are for the significant figures of the resistance and the 4th indicate the numbers of zeros following.
2% 产品 (E-96 系列阻值):
第 1~3 位表示阻值的有效数, 第 4 位表示有几个 0.

Feature (特性)

- Used for insulation protection and fusing protection of wire-wound (fusible) resistor.
用于涂装产品的绝缘防护及绕线（保险丝）电阻的熔断防护。
- This specification is applicable for KNP、KNPU product only. For the other products (size), please consult factory for the available specification and drawing.
适用于 KNP、KNPU 的产品，其他产品请洽谈工厂取得可生产的规格图样。



TZ Forming Type (TZ 轴向套管)

TZ-1 Wrapped resistor body only
TZ-1 套管包电阻本体

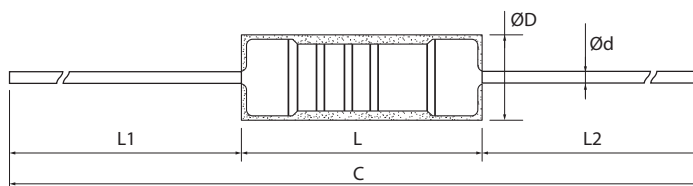

TZ-2 Wrapped resistor body and lead one side only
TZ-2 套管包电阻本体及一边导线

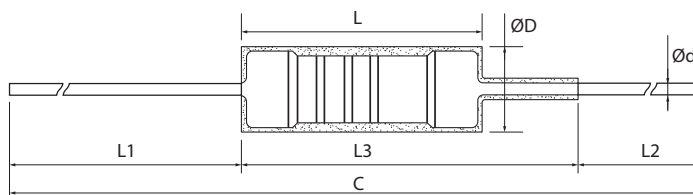

TZ-3 Wrapped resistor body and lead both two side
TZ-3 套管包电阻本体及两边导线

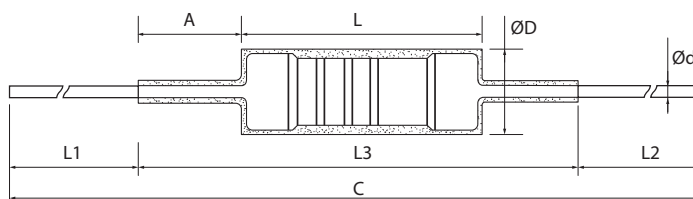

Dimension (尺寸) (mm)

| Type 类型 | Forming type 加工形态 | Dimension (尺寸) (mm) (L1、L2、L3 Adjustable range 可调范围) | | | | | | | |
|----------------|-------------------|--|------|-------|-------|--------|---------|----------|----------|
| | | D±1 | L±1 | L1 | L2 | L3 | Ød±0.05 | A (Max.) | C (Max.) |
| 1/4W、1/2W、1WSS | TZ-1 | | | 38 | 25 | / | | / | |
| | TZ-2 | 2.5 | 6.5 | 38 | 2Min. | 40Max. | 0.54 | / | Max.68mm |
| | TZ-3 | | | 2Min. | 2Min. | 40Max. | | 33 | |
| 1/2W、1WS、2WSS | TZ-1 | | | 38 | 25 | / | | / | |
| | TZ-2 | 3.5 | 9.5 | 38 | 2Min. | 40Max. | 0.54 | / | Max.71mm |
| | TZ-3 | | | 2Min. | 2Min. | 40Max. | | 30 | |
| 1W、2WS、3WSS | TZ-1 | | | 38 | 25 | / | | / | |
| | TZ-2 | 4.5 | 11.5 | 38 | 2Min. | 40Max. | 0.70 | / | Max.73mm |
| | TZ-3 | | | 2Min. | 2Min. | 40Max. | | 28 | |
| 2W、3WS、4WSS | TZ-1 | | | 38 | 25 | / | | / | |
| | TZ-2 | 5.5 | 15.5 | 38 | 2Min. | 40Max. | 0.70 | / | Max.77mm |
| | TZ-3 | | | 2Min. | 2Min. | 40Max. | | 25 | |

TM Forming Type (卧式套管)

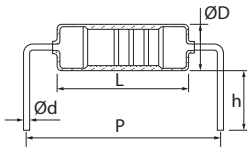

| Type 类型 | Dimension (尺寸)(mm) (Pitch adjustable range 脚距可调范围) | | | | |
|------------------|--|------|------|-------------|---------|
| | D±1 | L±1 | h | P | Ød±0.05 |
| 1/4W, 1/2W, 1WSS | 2.5 | 6.5 | 3min | 10 ~ 15 | 0.54 |
| 1/2W, 1WS, 2WSS | 3.5 | 9.5 | 3min | 12.5 ~ 17.5 | 0.54 |
| 1W, 2WS, 3WSS | 4.5 | 11.5 | 3min | 15 ~ 20 | 0.70 |
| 2W, 3WS, 4WSS | 5.5 | 15.5 | 3min | 20 ~ 25 | 0.70 |

TF Forming Type (立式套管)

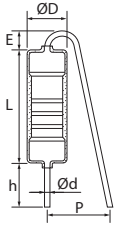

| Type 类型 | Dimension (尺寸)(mm) (Pitch adjustable range 脚距可调范围) | | | | | |
|------------------|--|------|------|-----|-----|---------|
| | D±1 | L±1 | h | E±1 | P | Ød±0.05 |
| 1/4W, 1/2W, 1WSS | 2.5 | 6.5 | 3min | 2.5 | 5~8 | 0.54 |
| 1/2W, 1WS, 2WSS | 3.5 | 9.5 | 3min | 2.5 | 5~8 | 0.54 |
| 1W, 2WS, 3WSS | 4.5 | 11.5 | 3min | 2.5 | 5~8 | 0.70 |
| 2W, 3WS, 4WSS | 5.5 | 15.5 | 3min | 2.5 | 5~8 | 0.70 |

Ordering Procedure (Example: KNPU 1W 5% 100Ω B/B TF Type)

订购方式 (例如: KNPU 1W 5% 100Ω B/B TF Type)

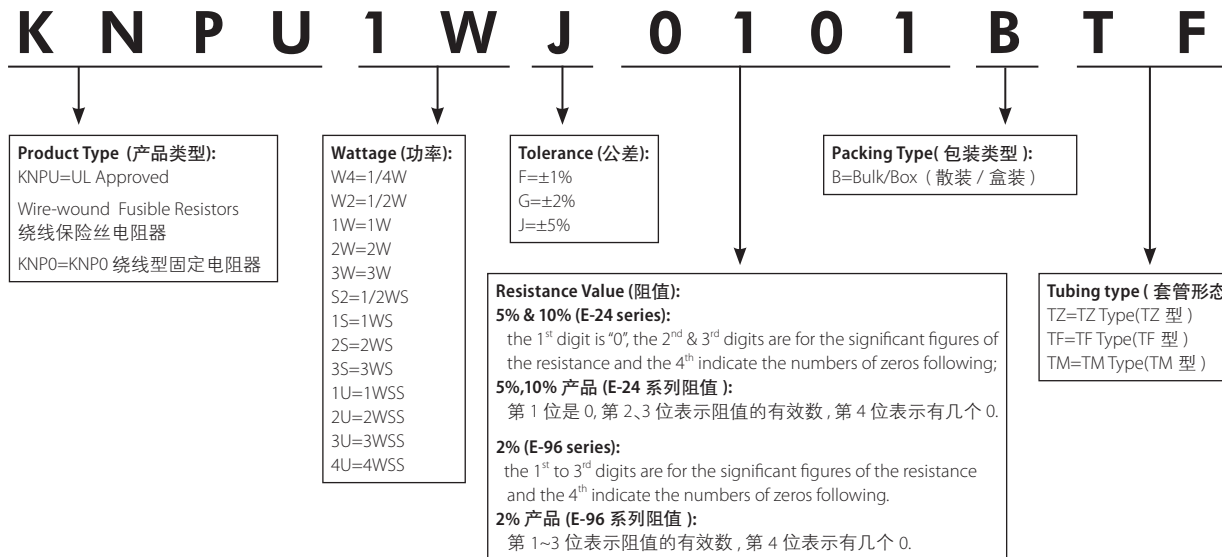

Feature (特性)

- High Power in small body size 小体积高功率
- Great design for SMD 良好的贴装设计
- Superior solderability of tin plated terminals 镀锡端子代理的可靠的焊接强度

Derating Curve (降功率曲线)

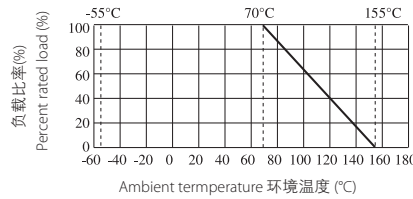

Dimension (尺寸)mm

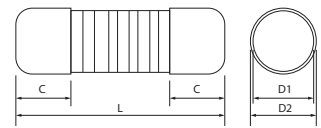

Specification (性能)

| Part No 料号 | Power Rating 功率 70°C | Dimension (尺寸)(mm) | | | | MAX.Working Voltage 最大工作电压 | MAX.Overload Voltage 最大过负荷电压 | Resistance Range 阻值范围 | Standard Packing (Reel) 标准包装 |
|---------------|-------------------------|--------------------|----------|---------|--------|-------------------------------|---------------------------------|--------------------------|---------------------------------|
| | | L | D1 | D2(Max) | C(Min) | | | | |
| MC12S8 | 1/8W | 2.0±0.1 | 1.2±0.05 | 1.4 | 0.4 | 150V | 300V | 1Ω~10MΩ | 3,000 |
| MC24W8 | | 3.5±0.2 | 1.4±0.15 | 1.55 | 0.5 | 200V | 400V | 1Ω~10MΩ | 3,000 |
| MC24S4 | 1/4W | 3.5±0.2 | 1.4±0.15 | 1.55 | 0.5 | 250V | 500V | 1Ω~10MΩ | 3,000 |
| MC27W4 | | 5.9±0.2 | 2.2±0.2 | 2.4 | 0.5 | 300V | 600V | 1Ω~10MΩ | 2,000 |
| MC27S2 | 1/2W | 5.9±0.2 | 2.2±0.2 | 2.4 | 0.5 | 300V | 600V | 1Ω~10MΩ | 2,000 |
| MC39W2 | | 8.5±0.2 | 3.2±0.2 | 3.4 | 0.5 | 350V | 700V | 1Ω~10MΩ | 2,500 |
| MC271U | 1W | 5.9±0.2 | 2.2±0.2 | 2.4 | 0.5 | 350V | 700V | 1Ω~10MΩ | 2,000 |
| MC391S | | 8.5±0.2 | 3.2±0.2 | 3.4 | 0.5 | 350V | 700V | 1Ω~10MΩ | 2,500 |
| MC392U | 2W | 8.5±0.2 | 3.2±0.2 | 3.4 | 0.5 | 350V | 700V | 1Ω~10MΩ | 2,500 |

Performance Specification (性能)

Temperature coefficient 1Ω~100KΩ: ±350PPM/°C
温度系数 101KΩ~500KΩ: ±700PPM/°C
 501KΩ~1MΩ: ±1000PPM/°C
 1MΩ~10MΩ: ±1500PPM/°C

Short-time Overload ΔR/R≤±(1%+0.05Ω),
短时间过负荷 with no evidence of mechanical damage
 (无可见机械损伤)

Resistance to soldering heat ΔR/R±(1%+0.05 Ω)
耐焊接热 with no evidence of mechanical damage
 (无可见机械损伤)

Temperature cycling ΔR/R≤±(1%+0.05Ω),
温度循环 with no evidence of mechanical damage
 (无可见机械损伤)

Load life in humidity ΔR/R≤±(5%+0.05Ω), with no evidence of
湿度寿命 mechanical damage
 (无可见机械损伤)

Load life ΔR/R≤±(2%+0.05Ω), with no evidence of
负载寿命 mechanical damage
 (无可见机械损伤)

Ordering Procedure (Example: MC24 1/4WS 5% 75Ω T/R-3000)

订购方式 (例如: MC24 1/4WS 5% 75Ω T/R-3000)

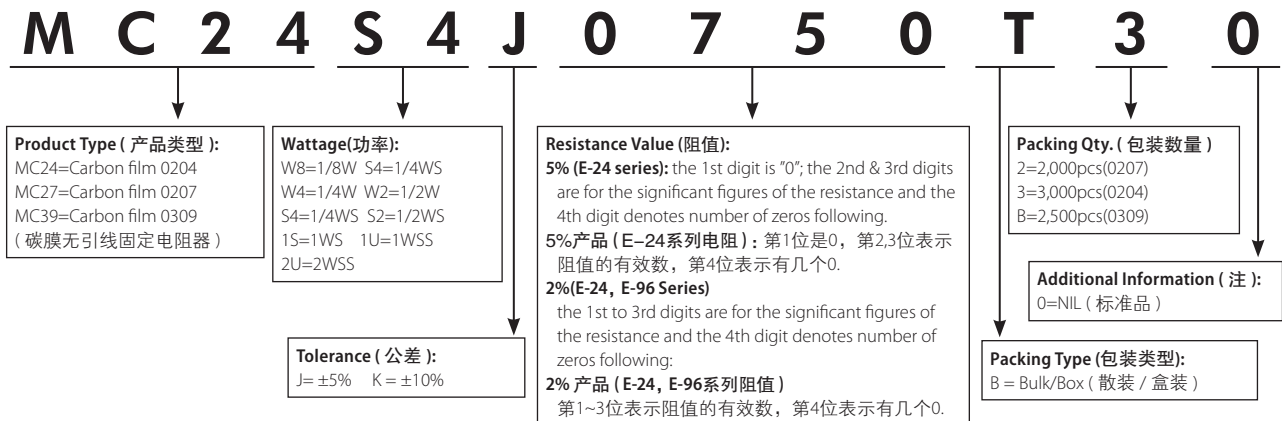

Feature (特性)

- High Power in small body size 小体积高功率
- Great design for SMD 良好的贴装设计
- Superior solderability of tin plated terminals
镀锡端子代理的可靠的焊接强度

Derating Curve (降功率曲线)

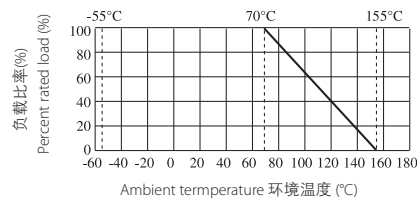

Dimension (尺寸)mm

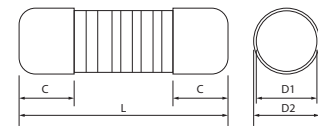

Specification (性能)

| Part No 料号 | Power Rating 功率 70 °C | Dimension (尺寸)(mm) | | | |
|---------------|--------------------------|----------------------|----------|---------|--------|
| | | L | D1 | D2(Max) | C(Min) |
| M12S8 | 1/8W-S | 2.0±0.1 | 1.2±0.05 | 1.4 | 0.4 |
| M24W8 | 1/8W | 3.5±0.2 | 1.4±0.15 | 1.55 | 0.5 |
| M24S4 | 1/4W-S | 3.5±0.2 | 1.4±0.15 | 1.55 | 0.5 |
| M27W4 | 1/4W | 5.9±0.2 | 2.2±0.2 | 2.4 | 0.5 |
| M27S2 | 1/2W-S | 5.9±0.2 | 2.2±0.2 | 2.4 | 0.5 |
| M39W2 | 1/2W | 8.5±0.2 | 3.2±0.2 | 3.4 | 0.5 |
| M271U | 1W-SS | 5.9±0.2 | 2.2±0.2 | 2.4 | 0.5 |
| M391S | 1W-S | 8.5±0.2 | 3.2±0.2 | 3.4 | 0.5 |
| M392U | 2W-SS | 8.5±0.2 | 3.2±0.2 | 3.4 | 0.5 |

Performance Specification (性能)

| | | |
|-------------------------|--------|---|
| Operating temperature | 工作温度范围 | -55°C~+155°C |
| Temperature coefficient | 温度系数 | ±15PPM/°C、±25PPM/°C、±50PPM/°C、±100PPM/°C |
| Short-time Overload | 短时间过负荷 | $\Delta R/R \leq \pm(0.5\%+0.05 \Omega)$ with no evidence of mechanical damage (无可见机械损伤) |
| Soldering heat | 耐焊接热 | $\Delta R/R \leq \pm(0.5\%+0.05 \Omega)$ with no evidence of mechanical damage (无可见机械损伤) |
| Solderability | 可焊性 | Min 95% coverage (最少 95% 覆盖率) |
| Load life in humidity | 湿度寿命 | $\Delta R/R \leq \pm(2\%+0.05 \Omega)$ with no evidence of mechanical damage (无可见机械损伤) |
| Load life | 负载寿命 | $\Delta R/R \leq \pm(3\%+0.05 \Omega)$ with no evidence of mechanical damage (无可见机械损伤) |

Performance Specification (性能)

| Part No 料号 | Power Rating 功率 70 °C | MAX. Working Voltage 最大工作电 压 | MAX. Overload Voltage 最大过负荷 电压 | Resistance Range 阻值范围 | Tolerance 公差 (%) | TCR (PPM/°C) | Resistance Range 阻值范围 | Tolerance 公差 (%) | TCR (PPM/°C) | Standard Packing (Reel) 标准包装 |
|---------------|-----------------------------|--|--|-----------------------------|---------------------|-----------------|-----------------------------|---------------------|-----------------|---------------------------------------|
| M1258 | 1/8W-S | 150V | 300V | 0.22Ω~3.9Ω | ±5% | ±100 | 100Ω~100KΩ | 0.1% | ±25 | 3,000 |
| | | | | 1Ω~3.9Ω | ±1% | ±100 | 100Ω~560KΩ | 0.1% | ±50 | |
| | | | | 4Ω~560KΩ | ±1% | ±50 | 100Ω~300KΩ | 0.25% | ±25 | |
| | | | | / | / | / | 100Ω~500KΩ | 0.5% | ±25 | |
| M24W8 | 1/8W | 150V | 300V | 10Ω~1MΩ | ±5% | ±200 | 100Ω~100KΩ | 0.1% | ±10 | 3,000 |
| | | | | 10Ω~1MΩ | ±2% | ±100 | 51.1Ω~330KΩ | 0.25% | ±25 | |
| | | | | 10Ω~1MΩ | ±1% | ±50 | 10Ω~1MΩ | 0.5% | ±50 | |
| M2454 | 1/4W-S | 200V | 400V | 0.1Ω~0.99Ω | ±5% | ±100 | 100Ω~560KΩ | 0.1% | ±50 | 3,000 |
| | | | | 1Ω~5.1MΩ | ±2%、±1% | ±50 | 10Ω~1MΩ | 0.25%、0.5% | ±50 | |
| | | | | 5.11MΩ~10MΩ | ±1% | ±100 | / | / | / | |
| | | | | 100Ω~560KΩ | ±1% | ±50 | / | / | / | |
| M27W4 | 1/4W | 250V | 500V | 0.1Ω~0.99Ω | ±5% | ±100 | 100Ω~100KΩ | 0.1% | ±15 | 2,000 |
| | | | | 1Ω~5.1MΩ | ±2%、±1% | ±50 | 100Ω~330KΩ | 0.25% | ±15 | |
| | | | | 5.11MΩ~10MΩ | ±1% | ±100 | 100Ω~560KΩ | 0.1%、 0.25%、0.5% | ±25 | |
| | | | | 100Ω~560KΩ | ±1% | ±25 | 10Ω~1MΩ | 0.25%、0.5% | ±50 | |
| M2752 | 1/2W-S | 250V | 500V | / | / | / | 100Ω~560KΩ | 0.1% | ±50 | 2,000 |
| | | | | 0.1Ω~0.99Ω | ±5% | ±100 | 100Ω~560KΩ | 0.1%、 0.25%、0.5% | ±50 | |
| | | | | 1Ω~5.1MΩ | ±2%、±1% | ±50 | / | / | / | |
| | | | | 5.11MΩ~10MΩ | ±1% | ±100 | / | / | / | |
| M39W2 | 1/2W | 350V | 700V | 100Ω~560KΩ | ±1% | ±25 | / | / | / | 2,500 |
| | | | | 0.1Ω~0.99Ω | ±5% | ±100 | 100Ω~100KΩ | 0.1% | ±15 | |
| | | | | 1Ω~5.1MΩ | ±2%、±1% | ±50 | 100Ω~100KΩ | 0.25% | ±15 | |
| | | | | 5.11MΩ~10MΩ | ±1% | ±100 | 100Ω~560KΩ | 0.1%、 0.25%、0.5% | ±25 | |
| M271U | 1W-SS | 350V | 700V | 100Ω~560KΩ | ±1% | ±25 | 100Ω~560KΩ | 0.1% | ±50 | 2,000 |
| | | | | / | / | / | 10Ω~1MΩ | 0.25%、0.5% | ±50 | |
| | | | | 0.1Ω~0.99Ω | ±5%、±1% | ±100 | 100Ω~100KΩ | 0.1% | ±15 | |
| | | | | 1Ω~5.1MΩ | ±2%、±1% | ±50 | 100Ω~330KΩ | 0.25% | ±15 | |
| M391S | 1W-S | 350V | 700V | 5.11MΩ~10MΩ | ±1% | ±100 | / | / | / | 2,500 |
| | | | | 100Ω~560KΩ | ±1% | ±25 | / | / | / | |
| | | | | 0.1Ω~0.99Ω | ±5% | ±100 | / | / | / | |
| | | | | 1Ω~5.1MΩ | ±2%、±1% | ±50 | / | / | / | |
| M392U | 2W-SS | 350V | 700V | 100Ω~560KΩ | ±1% | ±25 | / | / | / | 2,500 |
| | | | | 0.1Ω~0.99Ω | ±5% | ±100 | / | / | / | |
| | | | | 1Ω~5.1MΩ | ±2%、±1% | ±50 | / | / | / | |
| | | | | 5.11MΩ~10MΩ | ±1% | ±100 | / | / | / | |

Ordering Procedure (Example: M24 1/4WS 0.1% 100Ω 15PPM/°C T/R-3000)

订购方式 (例如: M24 1/4WS 0.1% 100Ω 15PPM/°C T/R-3000)

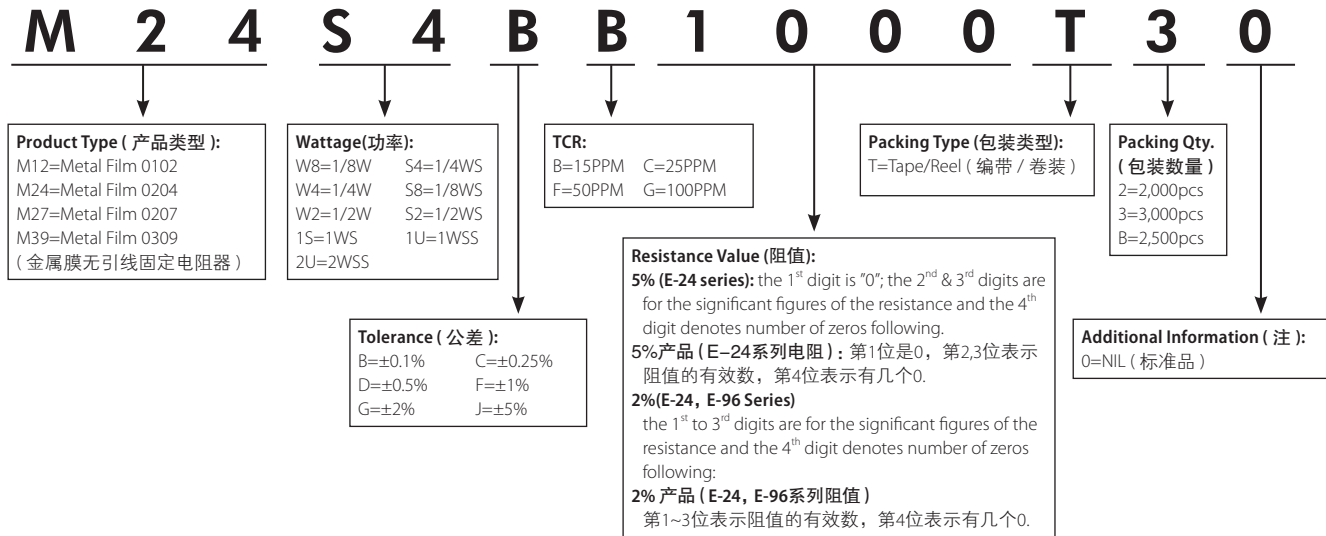

New/Old Part.no Contrast (新旧料号对照)

| New Part.no 新料号 | Old Part.no 旧料号 |
|-----------------|-----------------|
| M12S8FF****T*0 | SMF0S8F****T*0 |
| M24W8FF****T*0 | SMFOW8F****T*0 |
| M24S4FF****T*0 | SMF0S4F****T*0 |
| M27W4FF****T*0 | SMFOW4F****T*0 |
| M27S2FF****T*0 | SMF0S2F****T*0 |
| M39W2FF****T*0 | SMFOW2F****T*0 |
| M271UFF****T*0 | SMF01UF****T*0 |
| M391SFF****T*0 | SMF01SF****T*0 |
| M392UFF****T*0 | SMF02UF****T*0 |

Feature (特性)

- Made by Cu/Ni or Mn/Cu Alloy resistance wire materials
由铜 / 镍或锰 / 铜合金电阻线制成
- Excellent Solderability 优越的焊接性能
- Suitable for all kinds of Current sense application
适用于各种类型的电流感应器应用
- Application: Power Supply 电源供应

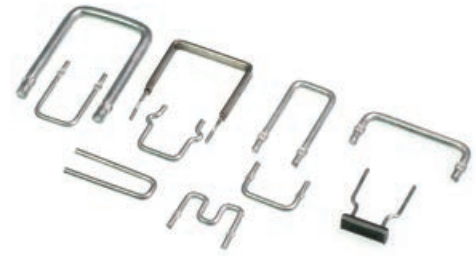

CSRA Type- CSRA 型

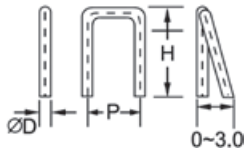

CSRB Type- CSRB 型

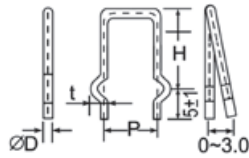

CSRC Type- CSRC 型

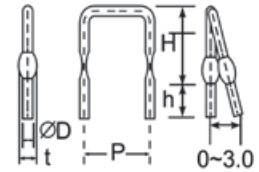

CSRD Type- CSRD 型

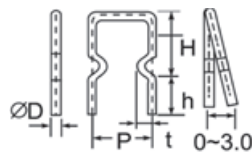

CSRE Type- CSRE 型

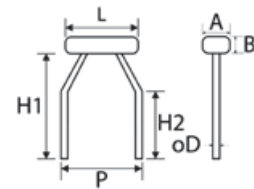

Specification(性能)

| Type 类型 | ØD 线径 | Rated Current 额定电流 | Resistance Range 阻值范围 | TCR | Remark 备注 |
|------------------------------|--------|-----------------------|--------------------------|------------|--|
| CSRA CSRB CSRC CSRD | Ø0.8mm | 4.5A | 5mΩ~50mΩ | ±100PPM/°C | *P&H could be design by customer's requirement P 值和 H 值可根据客户的要求进行设计 *Temperature coefficient of resistor could be design by customer's requirement 温度系数可根据客户的要求进行设计 |
| | Ø0.9mm | 5.0A | 5mΩ~40mΩ | | |
| | Ø1.0mm | 5.5A | 3mΩ~30mΩ | | |
| | Ø1.1mm | 6.0A | 3mΩ~20mΩ | | |
| | Ø1.2mm | 7.0A | 3mΩ~20mΩ | | |
| | Ø1.3mm | 7.5A | 3mΩ~20mΩ | | |
| | Ø1.4mm | 8.0A | 3mΩ~20mΩ | | |
| | Ø1.5mm | 9.0A | 3mΩ~20mΩ | | |
| | Ø1.6mm | 9.5A | 3mΩ~15mΩ | | |
| | Ø1.8mm | 11A | 3mΩ~10mΩ | | |
| CSRE | Ø2.0mm | 12A | 3mΩ~10mΩ | | |
| | Ø2.3mm | 14A | 3mΩ~7mΩ | | |
| | Ø1.0mm | 50A | 1mΩ | | |

Feature (特性)

- Made by Cu/Ni or Mn/Cu Alloy resistance wire materials
由铜 / 镍或锰 / 铜合金电阻线制成
- Excellent Solderability 优越的焊接性能
- Suitable for all kinds of Current sense application
适用于各种类型的电流感应器应用
- Application: Power Supply 电源供应



CSSA Type- CSSA 型

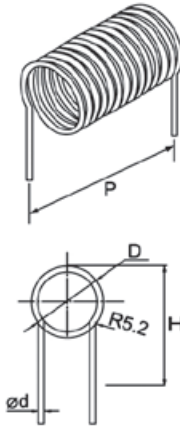

CSSB Type- CSSB 型

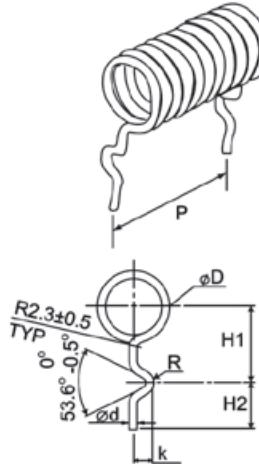

CSSC Type- CSSC 型

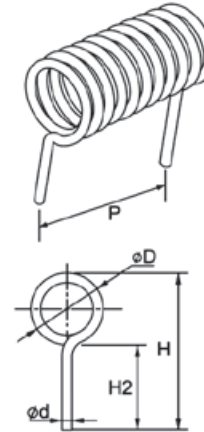

| Type 类型 | ΦD 线径 | Rated Current 额定电流 | Resistance Range 阻值范围 | Remark 备注 |
|----------------------|--------|--------------------|-----------------------|---|
| CSSA CSSB CSSC | Φ0.8mm | 4.5A | 5mΩ~50mΩ | *P&H could be design by customer's requirement *P 值和 H 值可根据客户的要求进行设计 |
| | Φ1.0mm | 5.5A | 3mΩ~30mΩ | |
| | Φ1.6mm | 9.5A | 3mΩ~15mΩ | |
| | Φ2.0mm | 12A | 3mΩ~10mΩ | |

Ordering Procedure (Example: CSRC Φ1.5mm 10mΩ±5% B/B)

订购方式 (例如: CSRC Φ1.5mm 10mΩ±5% B/B)

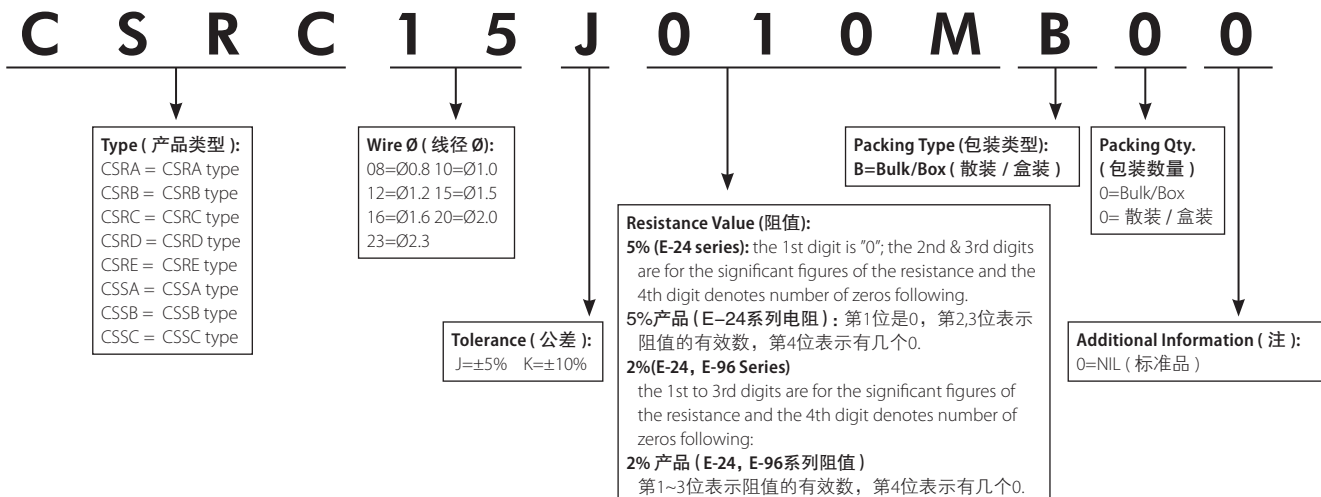

Tape in Box Packing (Ammo Pack) (编带盒装)

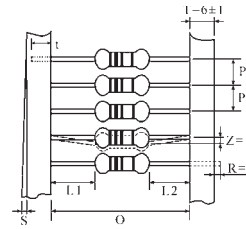
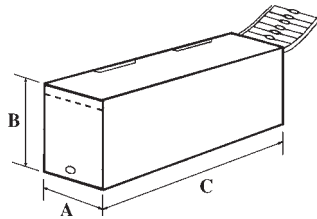

*L1-L2=1.0 Max. 最大
ZW: 0
**S=0.5 Max. 最大
PT-26: 0.8 Max. 最大

| Part No 料号 | Type 类型 | Dimension of T/B(尺寸)(mm) | | | | | Qty./Box 数量 / 盒 |
|---|------------|--------------------------|--------|-----|-----|-----|--------------------|
| | | O | P | A±5 | B±5 | C±5 | |
| Carbon Film Fixed Resistors (碳膜固定电阻器) | | | | | | | |
| CFR0W8 | CFR-12 | 52±1 | 5±0.3 | 75 | 70 | 255 | 5,000 |
| CFR0S4 | CFR-25-S | 52±1 | 5±0.3 | 75 | 70 | 255 | 5,000 |
| CFR0W4 | CFR-25 | 52±1 | 5±0.3 | 75 | 98 | 255 | 5,000 |
| CFR0W2 | CFR-50 | 52±1 | 5±0.3 | 75 | 45 | 255 | 1,000 |
| CFR01S | CFR-100-S | 52±1 | 5±0.3 | 86 | 82 | 255 | 1,000 |
| CFR01W | CFR-100 | 64±5 | 10±0.5 | 94 | 88 | 255 | 1,000 |
| CFR02S | CFR-200-S | 64±5 | 10±0.5 | 94 | 88 | 255 | 1,000 |
| CFR02W | CFR-200 | 64±5 | 10±0.5 | 90 | 88 | 255 | 500 |
| CFR03S | CFR-300-S | 64±5 | 10±0.5 | 90 | 88 | 255 | 500 |
| CPR0W2 | CPR-50 | 52±1 | 5±0.3 | 75 | 116 | 255 | 5,000 |
| CPR01W | CPR-100 | 52±1 | 5±0.3 | 75 | 45 | 255 | 1,000 |
| CPR02W | CPR-200 | 64±5 | 10±0.5 | 80 | 82 | 255 | 1,000 |
| Precision Metal Film Lilm Fixed Resistors (金属膜固定电阻器) | | | | | | | |
| MF0W8 | MF-12 | 52±1 | 5±0.3 | 75 | 70 | 255 | 5,000 |
| MF0S4 | MF-25-S | 52±1 | 5±0.3 | 75 | 70 | 255 | 5,000 |
| MF004 | MF-40-SS | 52±1 | 5±0.3 | 75 | 70 | 255 | 5,000 |
| MF0W4 | MF-25 | 52±1 | 5±0.3 | 75 | 98 | 255 | 5,000 |
| MF0S2 | MF-50-S | 52±1 | 5±0.3 | 75 | 98 | 255 | 5,000 |
| MF006 | MF-60-S | 52±1 | 5±0.3 | 75 | 98 | 255 | 5,000 |
| MF0W2 | MF-50 | 52±1 | 5±0.3 | 75 | 45 | 255 | 1,000 |
| MF01S | MF-100-S | 52±1 | 5±0.3 | 75 | 45 | 255 | 1,000 |
| MF01W | MF-100 | 52±1 | 5±0.3 | 86 | 82 | 255 | 1,000 |
| MF02S | MF-200-S | 52±1 | 5±0.3 | 86 | 82 | 255 | 1,000 |
| MF02W | MF-200 | 64±5 | 10±0.5 | 94 | 88 | 255 | 1,000 |
| MF03S | MF-300-S | 64±5 | 10±0.5 | 94 | 88 | 255 | 1,000 |
| MF03W | MF-300 | 64±5 | 10±0.5 | 90 | 88 | 255 | 500 |
| Metal Film Power Resistors (高功率金属膜电阻器) | | | | | | | |
| PMR01S | PMR-100-S | 52±1 | 5±0.3 | 75 | 98 | 255 | 5,000 |
| PMR02S | PMR-200-S | 52±1 | 5±0.3 | 86 | 82 | 255 | 1,000 |
| PMR03S | PMR-300-S | 64±5 | 10±0.5 | 90 | 88 | 255 | 1,000 |

Note: The above is recommended packaging, the actual packing method is in accordance with the order.
注: 以上为推荐包装方式, 实际以工厂依订单情形的包装方式为准

Tape in Box Packing (Ammo Pack) (编带盒装)

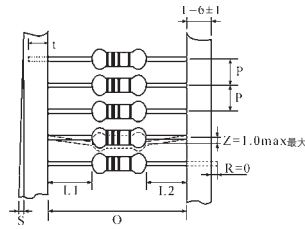
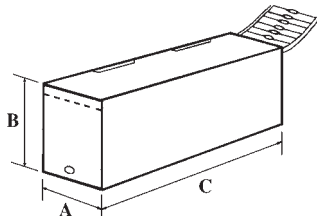

*L1-L2=1.0 Max. 最大
ZW: 0
**S=0.5 Max. 最大
PT-26: 0.8 Max. 最大

| Part No 料号 | Type 类型 | Dimension of T/B(尺寸)(mm) | | | | | Qty./Box 数量 / 盒 |
|---|------------|--------------------------|--------|-----|-----|-----|--------------------|
| | | O | P | A±5 | B±5 | C±5 | |
| Metal Oxide Film Fixed Resistors (金属氧化膜固定电阻器) | | | | | | | |
| MOR0W4 | MOR-25 | 52±1 | 5±0.3 | 75 | 116 | 255 | 5,000 |
| MOR0S2 | MOR-50-S | 52±1 | 5±0.3 | 75 | 116 | 255 | 5,000 |
| MOR0W2 | MOR-50 | 52±1 | 5±0.3 | 75 | 45 | 255 | 1,000 |
| MOR01S | MOR-100-S | 52±1 | 5±0.3 | 75 | 70 | 255 | 1,000 |
| MOR01W | MOR-100 | 52±1 | 5±0.3 | 86 | 82 | 255 | 1,000 |
| MOR02S | MOR-200-S | 52±1 | 5±0.3 | 86 | 82 | 255 | 1,000 |
| MOR02W | MOR-200 | 64±5 | 10±0.5 | 90 | 119 | 255 | 1,000 |
| MOR03S | MOR-300-S | 64±5 | 10±0.5 | 90 | 119 | 255 | 1,000 |
| MOR03W | MOR-300 | 64±5 | 10±0.5 | 90 | 88 | 255 | 500 |
| MOR05S | MOR-500-S | 64±5 | 10±0.5 | 90 | 88 | 255 | 500 |
| MOR05W | MOR-500 | 90±5 | 10±0.5 | 115 | 124 | 500 | 500 |
| Metal Glaze Film Fixed Resistors (精密玻璃釉膜固定电阻器) | | | | | | | |
| MGR0W4 | MGR-25 | 52±1 | 5±0.3 | 75 | 116 | 255 | 4,000 |
| MGR0W2 | MGR-50 | 52±1 | 5±0.3 | 75 | 70 | 255 | 1,000 |
| MGR01W | MGR-100 | 52±1 | 5±0.3 | 86 | 82 | 255 | 1,000 |
| MGR02W | MGR-200 | 64±5 | 10±0.5 | 90 | 119 | 255 | 1,000 |
| MGR03W | MGR-300 | 64±5 | 10±0.5 | 90 | 88 | 255 | 500 |
| MGR0S2 | MGR-50-S | 52±1 | 5±0.3 | 75 | 116 | 255 | 4,000 |
| MGR01S | MGR-100-S | 52±1 | 5±0.3 | 75 | 70 | 255 | 1,000 |
| MGR02S | MGR-200-S | 52±1 | 5±0.3 | 86 | 82 | 255 | 1,000 |
| MGR03U | MGR-300-SS | 52±1 | 5±0.3 | 86 | 82 | 255 | 1,000 |
| MGR03S | MGR-300-S | 64±5 | 10±0.5 | 90 | 119 | 255 | 1,000 |
| Fusible Resistors(保险丝电阻器) | | | | | | | |
| FRN0W4 | FRN-25 | 52±1 | 5±0.3 | 75 | 116 | 255 | 5,000 |
| FRN0S2 | FRN-50-S | 52±1 | 5±0.3 | 75 | 116 | 255 | 5,000 |
| FRN004 | FRN-40 | 52±1 | 5±0.3 | 75 | 116 | 255 | 5,000 |
| FRN0W2 | FRN-50 | 52±1 | 5±0.3 | 75 | 45 | 255 | 1,000 |
| FRN075 | FRN-75 | 52±1 | 5±0.3 | 80 | 70 | 255 | 1,000 |
| FRN01W | FRN-100 | 52±1 | 5±0.3 | 80 | 70 | 255 | 1,000 |
| FRN01A | FRN-150 | 52±1 | 5±0.3 | 86 | 82 | 255 | 1,000 |
| FRN02W | FRN-200 | 52±1 | 5±0.3 | 86 | 82 | 255 | 1,000 |
| FRN03W | FRN-300 | 64±5 | 10±0.5 | 90 | 119 | 255 | 1,000 |

Note: The above is recommended packaging, the actual packing method is in accordance with the order.
以上为推荐包装方式，实际以工厂依订单情形的包装方式为准

Tape in Box Packing (Ammo Pack) (编带盒装)

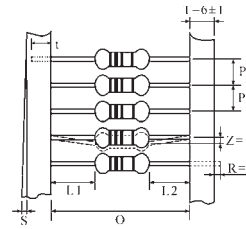
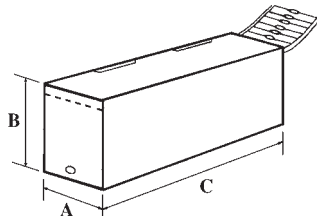

*L1-L2=1.0 Max. 最大
 ZW: 0
 **S=0.5 Max. 最大
 PT-26: 0.8 Max. 最大

| Part No 料号 | Type 类型 | Dimension of T/B(尺寸)(mm) | | | | | Qty./Box 数量 / 盒 |
|---|---------------------------|------------------------------------|--------|-----|-----|-----|--------------------|
| | | O | P | A±5 | B±5 | C±5 | |
| Wire Wound Fixed Resistors KNP (with Non-inductive KNPN & Anti-surge KNPA) 绕线固定器 (含无感型 KNPN 与耐脉冲型 KNPA) | | | | | | | |
| KNP*W4 | KNP*-25 | 52±1 | 5±0.3 | 75 | 116 | 255 | 5,000 |
| KNP*S2 | KNP*-50-S | 52±1 | 5±0.3 | 75 | 116 | 255 | 5,000 |
| KNP*W2 | KNP*-50 | 52±1 | 5±0.3 | 75 | 45 | 255 | 1,000 |
| KNP*1S | KNP*-100-S | 52±1 | 5±0.3 | 75 | 45 | 255 | 1,000 |
| KNP*1W | KNP*-100 | 52±1 | 5±0.3 | 86 | 82 | 255 | 1,000 |
| KNP*2S | KNP*-200-S | 52±1 | 5±0.3 | 86 | 82 | 255 | 1,000 |
| KNP*2W | KNP*-200 | 64±5 | 10±0.5 | 90 | 119 | 255 | 1,000 |
| KNP*3S | KNP*-300-S | 64±5 | 10±0.5 | 90 | 119 | 255 | 1,000 |
| KNP*3W | KNP*-300 | 64±5 | 10±0.5 | 90 | 88 | 255 | 500 |
| KNP*5S | KNP*-500-S | 64±5 | 10±0.5 | 90 | 88 | 255 | 500 |
| KNP*5W | KNP*-500 | 90±5 | 10±0.5 | 115 | 124 | 500 | 500 |
| KNP*7S | KNP*-700-S | 90±5 | 10±0.5 | 115 | 124 | 500 | 500 |
| Jumper Wires & Zero Ohm Resistors(跳线和零欧姆固定电阻器) | | | | | | | |
| ZWA0 | ZW-A | 52±1 | 5±0.3 | 75 | 98 | 255 | 10,000 |
| ZWB0 | ZW-B | 52±1 | 5±0.3 | 75 | 116 | 255 | 10,000 |
| ZWB-1 | ZW-B1 | 52±1 | 5±0.3 | 75 | 116 | 255 | 10,000 |
| ZWC0 | ZW-C | 52±1 | 5±0.3 | 75 | 116 | 255 | 8,000 |
| ZWD0 | ZW-D | 52±1 | 5±0.3 | 75 | 116 | 255 | 8,000 |
| ZWE0 | ZW-E | 52±1 | 5±0.3 | 75 | 116 | 255 | 7,000 |
| ZOT0W8 ZOC0W8 | ZOT-12 ZOC-12 | 52±1 | 5±0.3 | 75 | 70 | 255 | 5,000 |
| ZOT0W4 ZOC0W4 | ZOT-25 ZOC-25 | 52±1 | 5±0.3 | 75 | 98 | 255 | 5,000 |
| PT-26Type (PT-26 类型) | | | | | | | |
| CFR0W8 MF0W8 | CFR-12 MF-12 | 26 ^{+1.5} _{-1.0} | 5±0.5 | 50 | 66 | 255 | 5,000 |
| CFR0S4 MF0S4 | CFR-25-S MF-25-S | 26 ^{+1.5} _{-1.0} | 5±0.5 | 50 | 66 | 255 | 5,000 |
| MF004 | MF-40-SS | 26 ^{+1.5} _{-1.0} | 5±0.5 | 50 | 66 | 255 | 5,000 |
| CFR0W4 MF0W4 FRNOW4 | CFR-25 MF-25 FRN-25 | 26 ^{+1.5} ₋₀ | 5±0.5 | 50 | 100 | 255 | 5,000 |
| MF0S2 MOR0S2 | MF-50-S MOR-50-S | 26 ^{+1.5} ₋₀ | 5±0.5 | 50 | 100 | 255 | 5,000 |
| MF006 | MF-60-S | 26 ^{+1.5} ₋₀ | 5±0.5 | 50 | 100 | 255 | 5,000 |

Note: The above is recommended packaging, the actual packing method is in accordance with the order.
 以上为推荐包装方式，实际以工厂依订单情形的包装方式为准

Tape in Reel (编带卷装)

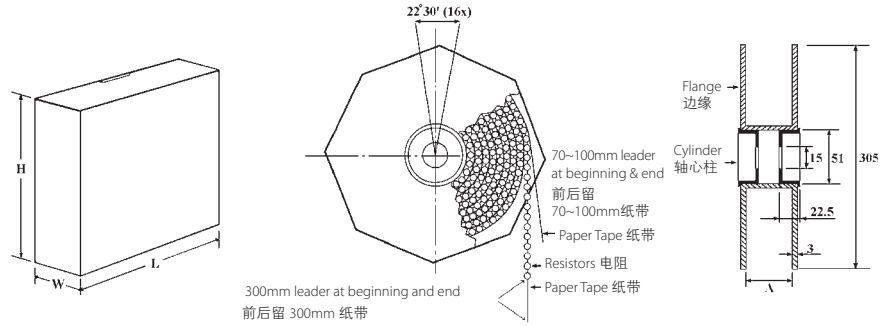

| Part No 料号 | Type 类型 | Dimension of T/R(尺寸)(mm) | | | | | Qty./Box 数量 / 盒 |
|---|------------|--------------------------|------|-----|-----|-----|--------------------|
| | | O | A | W±5 | H±5 | L±5 | |
| Carbon Film Fixed Resistors(碳膜固定电阻器) | | | | | | | |
| CFR0W8 | CFR-12 | 52±1 | 73±2 | 85 | 295 | 293 | 5,000 |
| CFR0S4 | CFR-25-S | 52±1 | 73±2 | 85 | 295 | 293 | 5,000 |
| CFR0W4 | CFR-25 | 52±1 | 73±2 | 85 | 295 | 293 | 5,000 |
| CFR0W2 | CFR-50 | 52±1 | 73±2 | 85 | 295 | 293 | 2,500 |
| CFR01S | CFR-100-S | 52±1 | 73±2 | 85 | 295 | 293 | 2,500 |
| CFR01W | CFR-100 | 64±5 | 80±5 | 95 | 295 | 293 | 1,000 |
| CFR02S | CFR-200-S | 64±5 | 80±5 | 95 | 295 | 293 | 1,000 |
| CFR02W | CFR-200 | 64±5 | 80±5 | 95 | 295 | 293 | 1,000 |
| CFR03S | CFR-300-S | 64±5 | 80±5 | 95 | 295 | 293 | 1,000 |
| CPR0W2 | CPR-50 | 52±5 | 73±2 | 85 | 295 | 293 | 5,000 |
| CPR01W | CPR-100 | 52±5 | 73±2 | 85 | 295 | 293 | 2,500 |
| CPR02W | CPR-200 | 64±5 | 80±5 | 95 | 295 | 293 | 2,500 |
| Precision Metal Film Fixed Resistors (金属膜固定电阻器) | | | | | | | |
| MF0W8 | MF-12 | 52±1 | 73±2 | 85 | 295 | 293 | 5,000 |
| MF0S4 | MF-25-S | 52±1 | 73±2 | 85 | 295 | 293 | 5,000 |
| MF004 | MF-40-SS | 52±1 | 73±2 | 85 | 295 | 293 | 5,000 |
| MF0W4 | MF-25 | 52±1 | 73±2 | 85 | 295 | 293 | 5,000 |
| MF0S2 | MF-50-S | 52±1 | 73±2 | 85 | 295 | 293 | 5,000 |
| MF0W2 | MF-50 | 52±1 | 73±2 | 85 | 295 | 293 | 2,500 |
| MF006 | MF-60-S | 52±1 | 73±2 | 85 | 295 | 293 | 5,000 |
| MF01S | MF-100-S | 52±1 | 73±2 | 85 | 295 | 293 | 2,500 |
| MF01W | MF-100 | 52±1 | 73±2 | 85 | 295 | 293 | 2,500 |
| MF02S | MF-200-S | 52±1 | 73±2 | 85 | 295 | 293 | 2,500 |
| MF02W | MF-200 | 64±5 | 80±5 | 95 | 295 | 293 | 1,000 |
| MF03S | MF-300-S | 64±5 | 80±5 | 95 | 295 | 293 | 1,000 |
| MF03W | MF-300 | 64±5 | 80±5 | 95 | 295 | 293 | 1,000 |
| Metal Film Power Resistors (高功率金属膜电阻器) | | | | | | | |
| PMR01S | PMR-100-S | 52±1 | 73±2 | 85 | 295 | 293 | 5,000 |
| PMR02S | PMR-200-S | 52±1 | 73±2 | 85 | 295 | 293 | 2,500 |
| PMR03S | PMR-300-S | 64±5 | 80±5 | 95 | 295 | 293 | 1,000 |

Note: The above is recommended packaging, the actual packing method is in accordance with the order.
以上为推荐包装方式，实际以工厂依订单情形的包装方式为准

Tape in Reel (编带卷装)

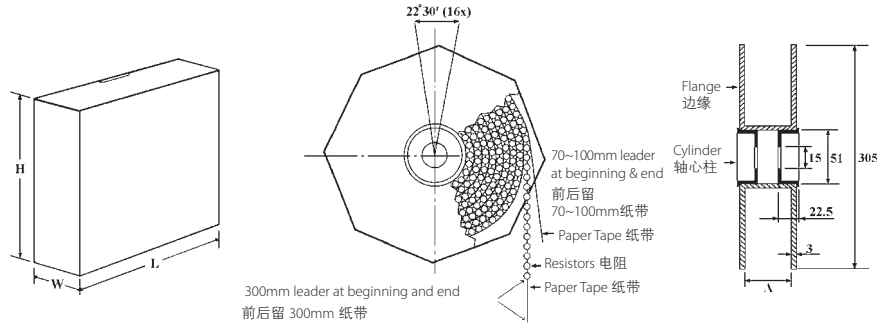

| Part No 料号 | Type 类型 | Dimension of T/R (尺寸)(mm) | | | | | Qty./Box 数量 / 盒 |
|---|------------|---------------------------|-------|-----|-----|-----|--------------------|
| | | O | A | W±5 | H±5 | L±5 | |
| Metal Oxide Film Fixed Resistors (金属氧化膜固定电阻器) | | | | | | | |
| MOR0W4 | MOR-25 | 52±1 | 73±2 | 85 | 295 | 293 | 5,000 |
| MOR0S2 | MOR-50-S | 52±1 | 73±2 | 85 | 295 | 293 | 5,000 |
| MOR0W2 | MOR-50 | 52±1 | 73±2 | 85 | 295 | 293 | 2,500 |
| MOR01S | MOR-100-S | 52±1 | 73±2 | 85 | 295 | 293 | 2,500 |
| MOR01W | MOR-100 | 52±1 | 73±2 | 85 | 295 | 293 | 2,500 |
| MOR02S | MOR-200-S | 52±1 | 73±2 | 85 | 295 | 293 | 2,500 |
| MOR02W | MOR-200 | 64±5 | 80±5 | 95 | 295 | 293 | 1,000 |
| MOR03S | MOR-300-S | 64±5 | 80±5 | 95 | 295 | 293 | 1,000 |
| MOR03W | MOR-300 | 64±5 | 80±5 | 95 | 295 | 293 | 1,000 |
| MOR05S | MOR-500-S | 64±5 | 80±5 | 95 | 295 | 293 | 1,000 |
| MOR05W | MOR-500 | 90±5 | 115±5 | 121 | 310 | 310 | 700 |
| Metal Glaze Film Fixed Resistors (精密玻璃釉膜固定电阻器) | | | | | | | |
| MGR0W4 | MGR-25 | 52±1 | 73±2 | 85 | 295 | 293 | 5,000 |
| MGR0W2 | MGR-50 | 52±1 | 73±2 | 85 | 295 | 293 | 2,500 |
| MGR01W | MGR-100 | 52±1 | 73±2 | 85 | 295 | 293 | 1,000 |
| MGR02W | MGR-200 | 64±5 | 80±5 | 95 | 295 | 293 | 1,000 |
| MGR03W | MGR-300 | 64±5 | 80±5 | 95 | 295 | 293 | 1,000 |
| MGR0S2 | MGR-50-S | 52±1 | 73±2 | 85 | 295 | 293 | 5,000 |
| MGR01S | MGR-100-S | 52±1 | 73±2 | 85 | 295 | 293 | 2,500 |
| MGR02S | MGR-200-S | 52±1 | 73±2 | 85 | 295 | 293 | 1,000 |
| MGR03U | MGR-300-SS | 52±1 | 73±2 | 85 | 295 | 293 | 1,000 |
| MGR03S | MGR-300-S | 64±5 | 80±5 | 95 | 295 | 293 | 1,000 |
| Fusible Resistors(保险丝电阻器) | | | | | | | |
| FRN0W4 | FRN-25 | 52±1 | 73±2 | 85 | 295 | 293 | 5,000 |
| FRN0S2 | FRN-50-S | 52±1 | 73±2 | 85 | 295 | 293 | 5,000 |
| FRN004 | FRN-40 | 52±1 | 73±2 | 85 | 295 | 293 | 5,000 |
| FRN0W2 | FRN-50 | 52±1 | 73±2 | 85 | 295 | 293 | 2,500 |
| FRN075 | FRN-75 | 52±1 | 73±2 | 85 | 295 | 293 | 2,500 |
| FRN01W | FRN-100 | 52±1 | 73±2 | 85 | 295 | 293 | 2,500 |
| FRN01A | FRN-150 | 52±1 | 73±2 | 85 | 295 | 293 | 2,500 |
| FRN02W | FRN-200 | 52±1 | 73±2 | 85 | 295 | 293 | 2,500 |
| FRN03W | FRN-300 | 64±5 | 80±5 | 95 | 295 | 293 | 1,000 |

Note: The above is recommended packaging, the actual packing method is in accordance with the order.
 以上为推荐包装方式，实际以工厂依订单情形的包装方式为准

Tape in Reel (编带卷装)

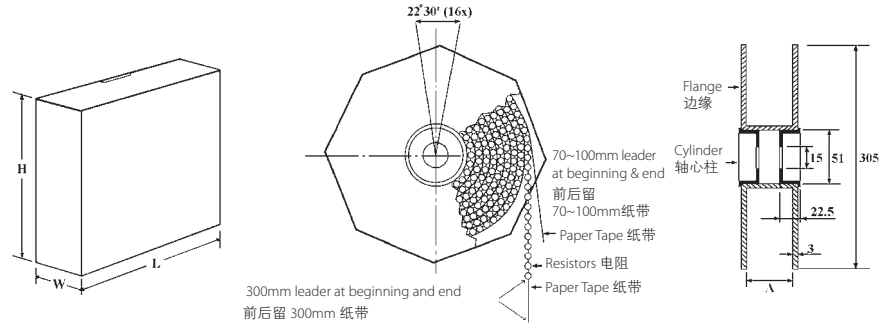

| Part No 料号 | Type 类型 | Dimension of T/R (尺寸) (mm) | | | | | Qty./Box 数量 / 盒 |
|--|------------|----------------------------|-------|-----|-----|-----|--------------------|
| | | O | A | W±5 | H±5 | L±5 | |
| Wire Wound Fixed Resistors KNP (with Non-inductive KNPN & Anti-surge KNPA) 绕线固定器 (含无感型 KNPN 与耐脉冲型 KNPA) | | | | | | | |
| KNP*W4 | KNP*-25 | 52±1 | 73±2 | 85 | 295 | 293 | 5,000 |
| KNP*S2 | KNP*-50-S | 52±1 | 73±2 | 85 | 295 | 293 | 5,000 |
| KNP*W2 | KNP*-50 | 52±1 | 73±2 | 85 | 295 | 293 | 2,500 |
| KNP*1S | KNP*-100-S | 52±1 | 73±2 | 85 | 295 | 293 | 2,500 |
| KNP*1W | KNP*-100 | 52±1 | 73±2 | 85 | 295 | 293 | 2,500 |
| KNP*2S | KNP*-200-S | 52±1 | 73±2 | 85 | 295 | 293 | 2,500 |
| KNP*2W | KNP*-200 | 64±5 | 80±5 | 95 | 295 | 293 | 1,000 |
| KNP*3S | KNP*-300-S | 64±5 | 80±5 | 95 | 295 | 293 | 1,000 |
| KNP*3W | KNP*-300 | 64±5 | 80±5 | 95 | 295 | 293 | 1,000 |
| KNP*5S | KNP*-500-S | 64±5 | 80±5 | 95 | 295 | 293 | 1,000 |
| KNP*5W | KNP*-500 | 90±5 | 115±5 | 121 | 310 | 310 | 700 |
| KNP*7S | KNP*-700-S | 90±5 | 115±5 | 121 | 310 | 310 | 700 |
| Jumper Wires & Zero Ohm Resistors(跳线和零欧姆固定电阻器) | | | | | | | |
| ZWA0 | ZW-A | 52±1 | 73±2 | 85 | 295 | 293 | 10,000 |
| ZWB0 | ZW-B | 52±1 | 73±2 | 85 | 295 | 293 | 10,000 |
| ZWB-1 | ZW-B1 | 52±1 | 73±2 | 85 | 295 | 293 | 10,000 |
| ZWC0 | ZW-C | 52±1 | 73±2 | 85 | 295 | 293 | 10,000 |
| ZWD0 | ZW-D | 52±1 | 73±2 | 85 | 295 | 293 | 10,000 |
| ZWE0 | ZW-E | 52±1 | 73±2 | 85 | 295 | 293 | 10,000 |
| ZOT0W8 ZOC0W8 | ZO-12 | 52±1 | 73±2 | 85 | 295 | 293 | 5,000 |
| ZOT0W4 ZOC0W4 | ZO-25 | 52±1 | 73±2 | 85 | 295 | 293 | 5,000 |

Note: The above is recommended packaging, the actual packing method is in accordance with the order.
以上为推荐包装方式，实际以工厂依订单情形的包装方式为准

Bulk in Box Packing (散装盒装)

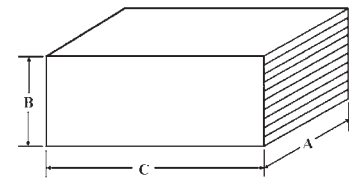
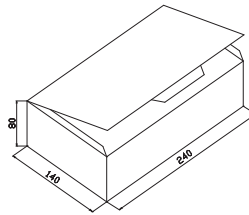

| Part No 料号 | Type 类型 | Dimension of B/B(尺寸)(mm) | | | Qty.of Bag/Box 袋数量 / 盒数量 |
|--|------------|--------------------------|-----|-----|-----------------------------|
| | | A±5 | B±5 | C±5 | |
| Carbon Film Fixed Resistors(碳膜固定电阻器) | | | | | |
| CFR0W8 | CFR-12 | 140 | 80 | 240 | 1,000/20,000 |
| CFR0S4 | CFR-25-S | 140 | 80 | 240 | 1,000/20,000 |
| CFR0W4 | CFR-25 | 140 | 80 | 240 | 500/10,000 |
| CFR0W2 | CFR-50 | 140 | 80 | 240 | 250/5,000 |
| CFR01S | CFR-100-S | 140 | 80 | 240 | 100/2,500 |
| CFR01W | CFR-100 | 140 | 80 | 240 | 100/1,500 |
| CFR02S | CFR-200-S | 140 | 80 | 240 | 100/1,500 |
| CFR02W | CFR-200 | 140 | 80 | 240 | 100/1,000 |
| CFR03S | CFR-300-S | 140 | 80 | 240 | 100/1,000 |
| CPR0W2 | CPR-50 | 140 | 80 | 240 | 500/10,000 |
| CPR01W | CPR-100 | 140 | 80 | 240 | 250/5,000 |
| CPR02W | CPR-200 | 140 | 80 | 240 | 100/2,500 |
| Precision Metal Film Fixed Resistors (金属膜固定电阻器) | | | | | |
| MF0W8 | MF-12 | 140 | 80 | 240 | 1,000/20,000 |
| MF0S4 | MF-25-S | 140 | 80 | 240 | 1,000/20,000 |
| MF004 | MF-40-SS | 140 | 80 | 240 | 1,000/20,000 |
| MF0W4 | MF-25 | 140 | 80 | 240 | 500/10,000 |
| MF0S2 | MF-50-S | 140 | 80 | 240 | 500/10,000 |
| MF0W2 | MF-50 | 140 | 80 | 240 | 250/5,000 |
| MF006 | MF-60-S | 140 | 80 | 240 | 500/10,000 |
| MF01S | MF-100-S | 140 | 80 | 240 | 250/5,000 |
| MF01W | MF-100 | 140 | 80 | 240 | 100/2,500 |
| MF02S | MF-200-S | 140 | 80 | 240 | 100/2,500 |
| MF02W | MF-200 | 140 | 80 | 240 | 100/1,500 |
| MF03S | MF-300-S | 140 | 80 | 240 | 100/1,500 |
| MF03W | MF-300 | 140 | 80 | 240 | 100/1,500 |
| Metal Film Power Resistors (高功率金属膜电阻器) | | | | | |
| PMR01S | PMR-100-S | 140 | 80 | 240 | 500/10,000 |
| PMR02S | PMR-200-S | 140 | 80 | 240 | 100/2,500 |
| PMR03S | PMR-300-S | 140 | 80 | 240 | 100/1,500 |

Note: The above is recommended packaging, the actual packing method is in accordance with the order.
以上为推荐包装方式，实际以工厂依订单情形的包装方式为准

Bulk in Box Packing (散装盒装)

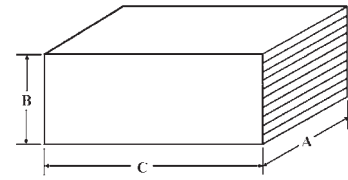
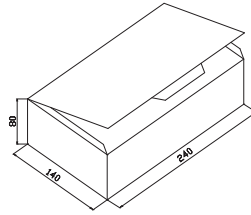

| Part No 料号 | Type 类型 | Dimension of B/B(尺寸)(mm) | | | Qty.of Bag/Box 袋数量 / 盒数量 |
|---|------------|--------------------------|-----|-----|-----------------------------|
| | | A±5 | B±5 | C±5 | |
| Metal Oxide Film Fixed Resistors (金属氧化膜固定电阻器) | | | | | |
| MOR0W4 | MOR-25 | 140 | 80 | 240 | 500/10,000 |
| MOR0S2 | MOR-50-S | 140 | 80 | 240 | 500/10,000 |
| MOR0W2 | MOR-50 | 140 | 80 | 240 | 250/5,000 |
| MOR01S | MOR-100-S | 140 | 80 | 240 | 250/5,000 |
| MOR01W | MOR-100 | 140 | 80 | 240 | 100/2,500 |
| MOR02S | MOR-200-S | 140 | 80 | 240 | 100/2,500 |
| MOR02W | MOR-200 | 140 | 80 | 240 | 100/1,500 |
| MOR03S | MOR-300-S | 140 | 80 | 240 | 100/1,500 |
| MOR03W | MOR-300 | 140 | 80 | 240 | 100/1,000 |
| MOR05S | MOR-500-S | 140 | 80 | 240 | 100/1,000 |
| MOR05W | MOR-500 | 140 | 80 | 240 | 25/400 |
| MOR07W | MOR-700 | 140 | 80 | 240 | 25/300 |
| MOR08W | MOR-800 | 140 | 80 | 240 | 25/200 |
| MOR09W | MOR-900 | 140 | 80 | 240 | 25/200 |
| Metal Glaze Film Fixed Resistors (精密玻璃釉膜固定电阻器) | | | | | |
| MGR0W4 | MGR-25 | 140 | 80 | 240 | 500/10,000 |
| MGR0W2 | MGR-50 | 140 | 80 | 240 | 250/5,000 |
| MGR01W | MGR-100 | 140 | 80 | 240 | 100/2,500 |
| MGR02W | MGR-200 | 140 | 80 | 240 | 100/1,500 |
| MGR03W | MGR-300 | 140 | 80 | 240 | 100/1,000 |
| MGR0S2 | MGR-50-S | 140 | 80 | 240 | 500/10,000 |
| MGR01S | MGR-100-S | 140 | 80 | 240 | 250/5,000 |
| MGR02S | MGR-200-S | 140 | 80 | 240 | 100/2,500 |
| MGR03U | MGR-300-SS | 140 | 80 | 240 | 100/2,500 |
| MGR03S | MGR-300-S | 140 | 80 | 240 | 100/1,500 |

Note: The above is recommended packaging, the actual packing method is in accordance with the order.
以上为推荐包装方式，实际以工厂依订单情形的包装方式为准

Bulk in Box Packing (散装盒装)

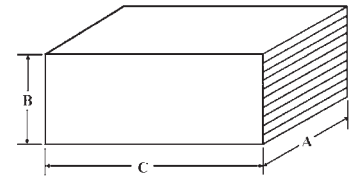
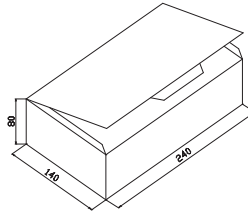

| Part No 料号 | Type 类型 | Dimension of B/B(尺寸)(mm) | | | Qty.of Bag/Box 袋数量 / 盒数量 |
|---|-------------|--------------------------|-----|-----|-----------------------------|
| | | A±5 | B±5 | C±5 | |
| Fusible Resistors(保险丝电阻器) | | | | | |
| FRN0W4 | FRN-25 | 140 | 80 | 240 | 500/10,000 |
| FRN0S2 | FRN-50-S | 140 | 80 | 240 | 500/10,000 |
| FRN004 | FRN-40 | 140 | 80 | 240 | 500/10,000 |
| FRN0W2 | FRN-50 | 140 | 80 | 240 | 250/5,000 |
| FRN075 | FRN-75 | 140 | 80 | 240 | 250/5,000 |
| FRN01W | FRN-100 | 140 | 80 | 240 | 250/5,000 |
| FRN01A | FRN-150 | 140 | 80 | 240 | 100/2,500 |
| FRN02W | FRN-200 | 140 | 80 | 240 | 100/2,500 |
| FRN03W | FRN-300 | 140 | 80 | 240 | 100/1,500 |
| Wire Wound Fixed Resistors KNP (with Non-inductive KNPN & Anti-surge KNPA) 绕线固定器 (含无感型 KNPN 与耐脉冲型 KNPA) | | | | | |
| KNP*W4 | KNP*-25 | 140 | 80 | 240 | 500/10,000 |
| KNP*S2 | KNP*-50-S | 140 | 80 | 240 | 500/10,000 |
| KNP*W2 | KNP*-50 | 140 | 80 | 240 | 250/5,000 |
| KNP*1S | KNP*-100-S | 140 | 80 | 240 | 250/5,000 |
| KNP*1W | KNP*-100 | 140 | 80 | 240 | 100/2,500 |
| KNP02S | KNP*-200-S | 140 | 80 | 240 | 100/2,500 |
| KNP*2W | KNP*-200 | 140 | 80 | 240 | 100/1,500 |
| KNP*3S | KNP*-300-S | 140 | 80 | 240 | 100/1,500 |
| KNP*3W | KNP*-300 | 140 | 80 | 240 | 100/1,000 |
| KNP*5S | KNP*-500-S | 140 | 80 | 240 | 100/1,000 |
| KNP*5W | KNP*-500 | 140 | 80 | 240 | 25/400 |
| KNP*7S | KNP*-700-S | 140 | 80 | 240 | 25/400 |
| KNP*7W | KNP*-700 | 140 | 80 | 240 | 25/300 |
| KNP*8S | KNP*-800-S | 140 | 80 | 240 | 25/300 |
| KNP*8W | KNP*-800 | 140 | 80 | 240 | 25/200 |
| KNP*9S | KNP*-900-S | 140 | 80 | 240 | 25/200 |
| KNP*9W | KNP*-900 | 140 | 80 | 240 | 25/200 |
| KNP*AS | KNP*-1000-S | 140 | 80 | 240 | 25/200 |
| Zero Ohm Resistors(零欧姆固定电阻器) | | | | | |
| ZOT0W8 ZOCOW8 | ZO-12 | 140 | 80 | 240 | 1,000/20,000 |
| ZOT0W4 ZOCOW4 | ZO-25 | 140 | 80 | 240 | 500/10,000 |

Note: The above is recommended packaging, the actual packing method is in accordance with the order.
以上为推荐包装方式，实际以工厂依订单情形的包装方式为准

Feature (特性)

- Miniature, high density packaging
小型高密度封装
- High reliability $R_{10}O_2$ paste
使用高稳定性 $R_{10}O_2$ 电阻材料

Application (应用)

- Control circuit V.C.R. (V.C.R.控制电路)
- Air-conditioner (空调)
- Computer, color TV (计算机, 彩电)
- Facsimile (传真机)

Dimension (尺寸) (mm)

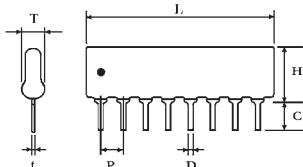

●*indicate the 1st pin (表示第一脚位置)

Derating Curve (降功率曲线)

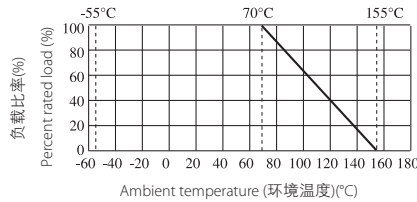

| Type 类型 | Dimension of L(Max.) L 的最大尺寸 | | | | | | | | | | | H max | C +0.5 -0.3 | T max | t±0.05 | P±0.2 | D±0.1 |
|------------|------------------------------|------|------|------|------|------|--------|--------|--------|--------|--------|----------|-------------------|----------|--------|-------|-------|
| | 4pin | 5pin | 6pin | 7pin | 8pin | 9pin | 10 pin | 11 pin | 12 pin | 13 pin | 14 pin | | | | | | |
| RNL | 10.2 | 12.7 | 15.3 | 17.8 | 20.4 | 22.9 | 25.4 | 28.0 | 30.5 | 33.1 | 35.6 | 5.08 | 3.3 | 2.5 | 0.25 | 2.54 | 0.5 |
| RPL | 10.2 | 12.7 | 15.3 | 17.8 | 20.4 | 22.9 | 25.4 | 28.0 | 30.5 | 33.1 | 35.6 | 5.08 | 3.3 | 2.5 | 0.25 | 2.54 | 0.5 |
| RNM | 10.2 | 12.7 | 15.3 | 17.8 | 20.4 | 22.9 | 25.4 | 28.0 | 30.5 | 33.1 | 35.6 | 6.35 | 3.3 | 2.5 | 0.25 | 2.54 | 0.5 |
| RPH | 10.2 | 12.7 | 15.3 | 17.8 | 20.4 | 22.9 | 25.4 | 28.0 | 30.5 | 33.1 | 35.6 | 8.89 | 3.3 | 2.5 | 0.25 | 2.54 | 0.5 |

Circuit Structure (电路结构)

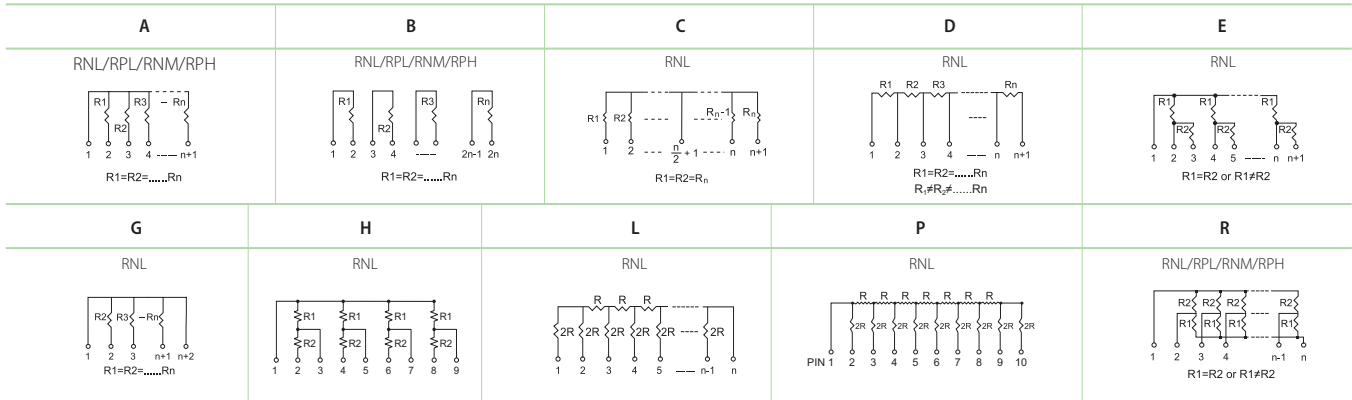

* Custom Design Circuit could be available on a case to case basis. (可按客户特殊要求定制)

Package Power Ratings (封装功率等级)

| Type 类型 | 4PIN | 5PIN | 6PIN | 7PIN | 8PIN | 9PIN | 10PIN | 11PIN | 12PIN | 13PIN | 14PIN |
|------------|------|-------|-------|-------|-------|-------|-------|-------|-------|-------|-------|
| RPL | 0.5W | 0.63W | 0.75W | 0.88W | 1.0W | 1.13W | 1.25W | 1.38W | 1.5W | 1.63W | 1.75W |
| RNM | 0.6W | 0.75W | 0.9W | 1.05W | 1.20W | 1.35W | 1.50W | 1.65W | 1.80W | 1.95W | 2.10W |
| RPH | 0.8W | 1.0W | 1.2W | 1.4W | 1.6W | 1.8W | 2.0W | 2.2W | 2.4W | 2.6W | 2.8W |

| Type 类型 | Power Rating (功率) 70°C | Max. Working Voltage 最大工作电压 | Max. Overload Voltage 最大过负荷电压 | Dielectric Withstanding Voltage 绝缘耐压 | Resistance Range 阻值范围 | Tolerance 公差 | Operating Temperature 工作温度范围 |
|---------|---|-----------------------------|-------------------------------|--------------------------------------|--|--------------|------------------------------|
| RNL | B type(B 型): 0.2W Others(其它类型): 0.125W | 100V | 150V | 200V | R Type(R 型): 100Ω~10K Others(其它类型): 10Ω~1MΩ | ±2% ±5% | -55°C~+155°C |
| | A:0.2W | | | | 10Ω~1MΩ | | |
| RPL | B:0.3W R:0.2W | 100V | 150V | 200V | 10Ω~1MΩ 100Ω~10KΩ | ±2% ±5% | -55°C~+155°C |
| | A:0.25W | | | | 10Ω~1MΩ | | |
| RNM | B:0.4W R:0.25W | 100V | 150V | 200V | 10Ω~1MΩ 100Ω~10KΩ | ±2% ±5% | -55°C~+155°C |
| | A:0.3W | | | | 10Ω~1MΩ | | |
| RPH | B:0.5W R:0.3W | 100V | 150V | 200V | 10Ω~1MΩ 100Ω~10KΩ | ±2% ±5% | -55°C~+155°C |

Marking (Single Value) [标示(单个阻值)]:

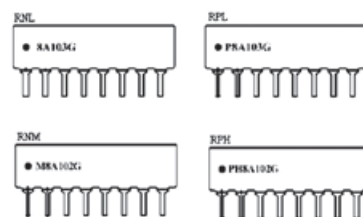
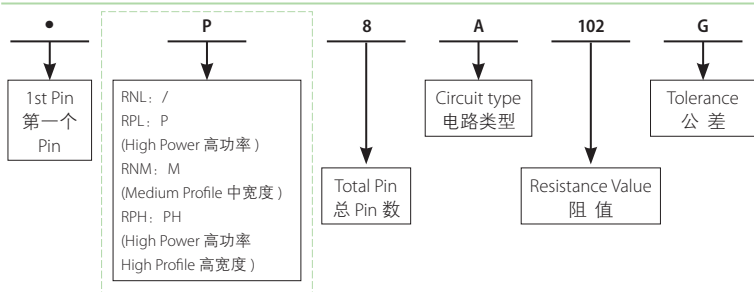

Marking(Dual Value)[标示(双阻类型)]:

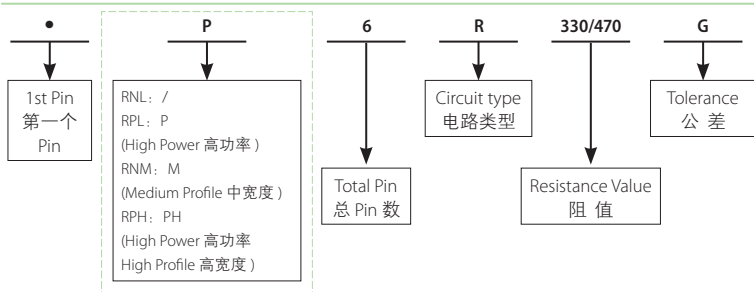

Dual Value (双阻型阻值系列)(R1/R2)(Ohm)

| | |
|-----------|-------------|
| 160 / 240 | 330 / 390 |
| 180 / 390 | 330 / 470 |
| 220 / 270 | 1.5K / 3.5K |
| 220 / 330 | 3.0K / 6.2K |

* Special Value available on a case to case basis. (另可按客户特殊要求订做)

Performance Specification(性能)

| Test Item 试验项目 | | Evaluation Criteria 判定标准 | | | |
|---------------------------------|--------|--|-----|---|-----|
| | | RNL | RPL | RNM | RPH |
| Temperature | 温度系数 | 50Ω~1MΩ: ±200PPM/°C <50Ω&>1MΩ: ±250PPM/°C | | | |
| Short-time overload | 短时间过负荷 | $\Delta R/R \leq \pm(0.5\%+0.1\Omega)$ | | | |
| Insulation resistance | 绝缘电阻 | $\geq 10,000M\Omega$ | | | |
| Dielectric withstanding voltage | 绝缘耐压 | No Evidence of flashover, arcing or insulation breakdown (无击穿、飞弧及可见机械损伤) | | | |
| Terminal strength | 端子强度 | $\Delta R/R \leq \pm(0.5\%+0.1\Omega)$ | | $\Delta R/R \leq \pm(0.25\%+0.1\Omega)$ | |
| Soldering heat | 耐焊接热 | $\Delta R/R \leq \pm(0.5\%+0.1\Omega)$ | | | |
| Solderability | 可焊性 | Min.95% coverage (最少 95% 覆盖率) | | | |
| Thermal shock | 热冲击 | $\Delta R/R \leq \pm(0.5\%+0.1\Omega)$ | | $\Delta R/R \leq \pm(0.25\%+0.1\Omega)$ | |
| Temperature cycling | 温度循环 | $\Delta R/R \leq \pm(0.5\%+0.1\Omega)$ | | | |
| Load life in humidity | 湿度寿命 | $\Delta R/R \leq \pm(3\%+0.1\Omega)$ | | $\Delta R/R \leq \pm(0.5\%+0.1\Omega)$ | |
| Load life | 负载寿命 | $\Delta R/R \leq \pm(3\%+0.1\Omega)$ | | $\Delta R/R \leq \pm(1\%+0.1\Omega)$ | |

Ordering Procedure (Example: RNL A type 10 PIN 2% 10KΩ B/B)

订购方式 (例如: RNL A 型 10 PIN 2% 10KΩ B/B)

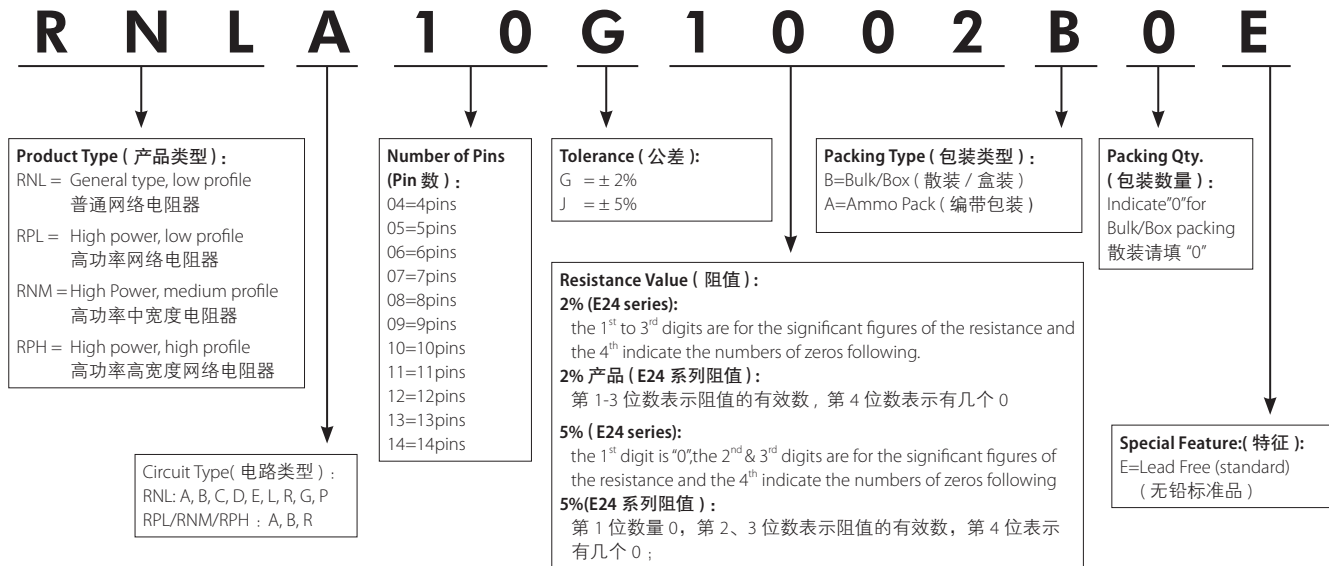

Standard Packing of Resistor Network (网络电阻器的标准包装)

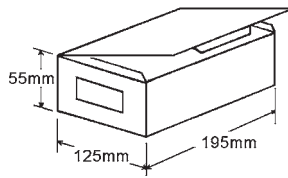

| Type 类型 | Pins 引脚数 | Weight of 1,000pcs 1,000只重量 (g) | Qty.per Bag 每袋数量 | Qty.per Box 每盒数量 | Qty.per Carton 每箱数量 | Type 类型 | Pins 引脚数 | Weight of 1,000pcs 1,000只重量 (g) | Qty.per Bag 每袋数量 | Qty.per Box 每盒数量 | Qty.per Carton 每箱数量 |
|---------|----------|---------------------------------|------------------|------------------|---------------------|---------|----------|---------------------------------|------------------|------------------|---------------------|
| RNL RPL | 4 | 210 | 200 | 1,000 | 30,000 | RNL RPL | 10 | 530 | 200 | 1,000 | 30,000 |
| RNM | | 240 | 100 | | | RNM | | 610 | 50 | 500 | 15,000 |
| RPH | | 330 | 100 | | | RPH | | 870 | 50 | 500 | 15,000 |
| RNL RPL | 5 | 250 | 200 | 1,000 | 30,000 | RNL RPL | 11 | 600 | 100 | 500 | 15,000 |
| RNM | | 300 | 100 | | | RNM | | 670 | 50 | | |
| RPH | | 410 | 100 | | | RPH | | 950 | 50 | | |
| RNL RPL | 6 | 320 | 200 | 1,000 | 30,000 | RNL RPL | 12 | 650 | 100 | 500 | 15,000 |
| RNM | | 360 | 100 | | | RNM | | 730 | 50 | | |
| RPH | | 490 | 100 | | | RPH | | 1030 | 50 | | |
| RNL RPL | 7 | 360 | 200 | 1,000 | 30,000 | RNL RPL | 13 | 710 | 100 | 500 | 15,000 |
| RNM | | 420 | 100 | | | RNM | | 790 | 50 | | |
| RPH | | 570 | 100 | | | RPH | | 1130 | 50 | | |
| RNL RPL | 8 | 430 | 200 | 1,000 | 30,000 | RNL RPL | 14 | 770 | 100 | 500 | 15,000 |
| RNM | | 480 | 100 | | | RNM | | 850 | 50 | | |
| RPH | | 660 | 50 | | | RPH | | 1210 | 50 | | |
| RNL RPL | 9 | 450 | 200 | 1,000 | 30,000 | RNL RPL | 14 | 770 | 100 | 500 | 15,000 |
| RNM | | 540 | 50 | | | RNM | | 850 | 50 | | |
| RPH | | 760 | 50 | | | RPH | | 1210 | 50 | | |

Ammo Pack of Resistor Network (网络电阻器编带包装)

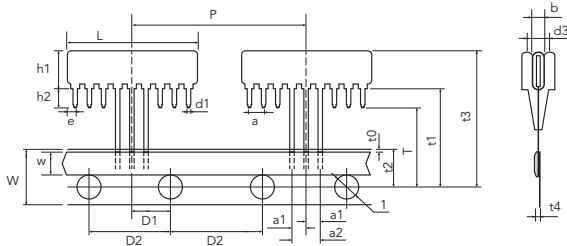

* ... n=Pin Count

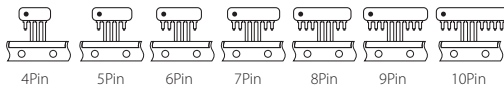

| Dimension 尺寸 (mm) | | Dimension 尺寸 (mm) | |
|-------------------|------------|-------------------|-----------|
| H1 | Max 5.08 | t0 | 2.0Max |
| L | Max 2.54*n | t1 | 18.99±0.5 |
| a | 2.54±0.25 | t2 | 9.0±0.5 |
| d1 | 0.5±0.1 | t3 | 24.46Max |
| P | 25.4±1.0 | t4 | 1.5max |
| W | 18±0.5 | l | φ4.0±0.3 |
| w | 5.0min | h2 | 3.0±0.5 |
| P1 | 6.35±0.7 | a1 | 2.54±0.25 |
| P2 | 12.7±0.3 | a2 | 5.08±0.3 |
| B | Max 2.49 | d3 | 2.0Max |
| T | 16±0.5 | / | / |

Packing quantity (包装数量)

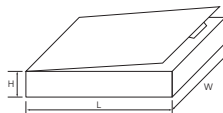

The inner box sizes 内盒尺寸：
4~9pin: 320(L) × 207(W) × 40(H)mm
10pin: 315(L) × 295(W) × 40(H)mm

| Pins 引脚数 | Qty.per Box 每盒数量 | Qty.per Carton 每箱数量 |
|----------|------------------|---------------------|
| 4~10 | 1,000 | 12,000 |

Special Network-SIP Series

特殊网络电阻器 SIP 系列

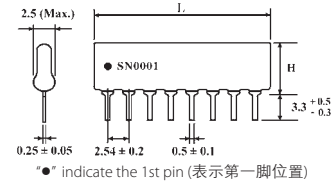

| Type(类型) | SN0001 | SN0002 | SN0003 | SN0004 |
|----------------------------------|--|-----------------------------|--|---|
| Circuit Structure (电路结构) | R1=500Ω ±5% R2=40K ±5% (TO: R3: ±1%) R3=10K ±5% R4=RS=75K ±5% R6=100K ±5% R7=10K ±1% | R1=33KΩ ±5% R2=22KΩ ±5% | R3=9K1 R1=120K R14=24K R4=36K R8=14K R15=1K5 R5=607K5 R10=R11=R12=20K R13=2K R7=52K5 R13=11K | R1=520Ω R2=700Ω R3=121Ω R4=249Ω R5=1K33 R6=619K R7=174Ω R8=75Ω |
| Dimension of L(max) 尺寸 L(最大) | 10PINS:25.4mm | 10PINS:25.4mm | 10PINS:43.2mm | 9PINS:22.9mm |
| H(max) H(最大) | 5.08mm | 5.08mm | 6.35mm | 5.08mm |
| Power Rating at 70°C 功率 70°C | 0.2W | 0.2W | 0.125W | 0.125W |
| Max Working Voltage 最大工作电压 | 100V | 100V | 100V | 100V |
| Max Overload Voltage 最大过负荷电压 | 150V | 150V | 200V | 150V |
| Operating Temperature 工作温度 | -55~+155 °C | -55~+155°C | -55~+155 °C | -55~+155 °C |

* Custom Design Circuit could be available on a case to case basis (可提供客户特殊要求之线路产品)

Resistor/Capacitor Network - SIP Series

网络阻容器 - SIP 系列

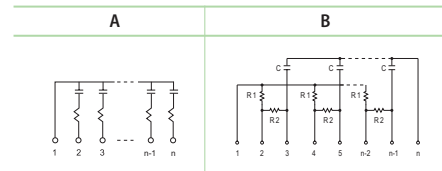
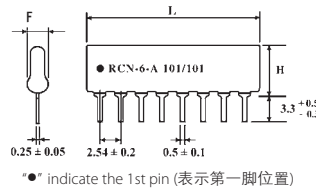

Electrical Characteristics- Capacitor (电容特性)

| Capacitance Dielectric 电容介质 | Capacitance Range 电容范围 | Capacitance Tolerance 电容公差 | Capacitance Voltage 电容电压 |
|--------------------------------|---------------------------|-------------------------------|-----------------------------|
| NPO | 39pF~270pF | ±10% | 50V |
| X7R | >270pF~0.1μF | ±20% | |

Dimension (尺寸) (mm):

| Type 类型 | H (mm) | F (mm) |
|---------|-----------|-----------|
| RCH | 7.62 Max. | 3.81 Max. |
| RCN | 8.89 Max. | 3.81 Max. |

Dimension (尺寸) (mm):

| L | |
|---------------|----------------|
| 4 PIN: 10.2mm | 10 PIN: 25.4mm |
| 5 PIN: 12.7mm | 11 PIN: 28.0mm |
| 6 PIN: 15.3mm | 12 PIN: 30.5mm |
| 7 PIN: 17.8mm | 13 PIN: 33.1mm |
| 8 PIN: 20.4mm | 14 PIN: 35.6mm |
| 9 PIN: 22.9mm | |

* Custom Design Circuit could be available on a case to case basis (可提供客户特殊要求之线路产品)

Capacitor Network-SIP Series

网络电容器 SIP 系列

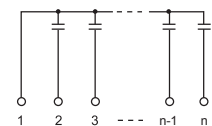
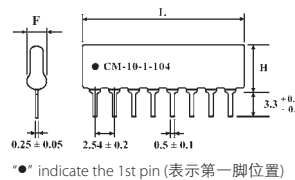

● indicate the 1st pin (表示第一脚位置)

Circuit Structure (电路结构)

Electrical Characteristics- Capacitor (电容特性)

| Capacitance Dielectric 电容介质 | Capacitance Range 电容范围 | Capacitance Tolerance 电容公差 | Capacitance Voltage 电容电压 |
|--------------------------------|---------------------------|-------------------------------|-----------------------------|
| NPO | 39pF~270pF | ±10% | 50V |
| X7R | >270pF~0.1μF | ±20% | |

Dimension (尺寸) (mm):

| Type 类型 | H (mm) | F (mm) |
|---------|-----------|-----------|
| CNM | 6.35 Max. | 3.81 Max. |
| CNH | 7.62 Max. | 3.81 Max. |

Dimension (尺寸) (mm):

| L | |
|---------------|----------------|
| 4 PIN: 10.2mm | 10 PIN: 25.4mm |
| 5 PIN: 12.7mm | 11 PIN: 28.0mm |
| 6 PIN: 15.3mm | 12 PIN: 30.5mm |
| 7 PIN: 17.8mm | 13 PIN: 33.1mm |
| 8 PIN: 20.4mm | 14 PIN: 35.6mm |
| 9 PIN: 22.9mm | |

* Custom Design Circuit could be available on a case to case basis (可提供客户特殊要求之线路产品)

Feature (特性)

- Small size, Light weight 小尺寸，重量轻
- High stability, Reliability 高稳定性，高可靠性
- Max working voltage 10KV 最大工作电压可达10KV
- Used in Microwave Ovens, Induction Cooker, High Voltage Power Supply, Laser light control circuit and other applications
用于微波炉、电磁炉、高压电源、激光控制电路及其它产品



Dimension (尺寸) (mm)

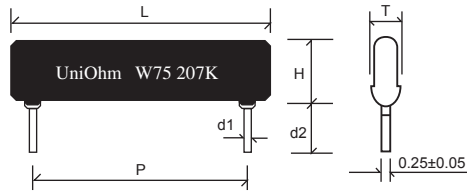

Derating Curve & Specification (降功率曲线和性能)

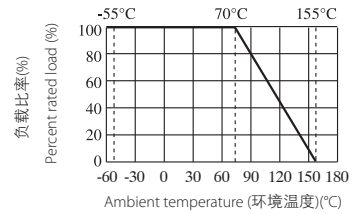

| Part No. 料号 | Type 类型 | Power rating 功率 70°C | Dimension (尺寸)(mm) | | | | | | Max Working Voltage 最大工作电压 | Dielectric Withstanding Voltage 绝缘耐压 | Resistance Range 阻值范围 |
|----------------|------------|-------------------------|--------------------|----------------|--------|------------------------------------|----------------|----------------|-------------------------------|---|--------------------------|
| | | | P±0.5 | L(max) L 最大 | d1±0.1 | d2 ^{+0.5} _{-0.2} | H(max) H 最大 | T(max) T 最大 | | | |
| HFR0W2 | HFR-50 | 0.5W | 17.8 | 20.4 | 0.5 | 3.5 | 5.08 | 2.5 | 5KV | 500V | 1M~1GΩ |
| HFR007 | HFR-75 | 0.75W | 22.9 | 25.4 | 0.5 | 3.5 | 5.08 | 2.5 | 10KV | 500V | 1M~1GΩ |
| HFR01W | HFR-100 | 1W | 27.9 | 30.5 | 0.5 | 3.5 | 5.08 | 2.5 | 10KV | 500V | 1M~1GΩ |

Performance Specification (性能)

| | | | | | |
|-------------------------|------|-------------------------------|-------------------------|------|-------------------|
| Temperature coefficient | 温度系数 | ±200PPM/°C | Humidity (Steady State) | 恒定湿热 | ΔR/R±(1.0%+0.1 Ω) |
| Terminal strength | 端子强度 | ΔR/R±(1%+0.1Ω) | Load life in humidity | 湿度寿命 | ΔR/R±(3.0%+0.1Ω) |
| Soldering heat | 耐焊接热 | ΔR/R±(1%+0.1 Ω) | Load life | 负载寿命 | ΔR/R±(3.0%+0.1Ω) |
| Solderability | 可焊性 | Min.95% coverage (最少 95% 覆盖率) | Insulation resistance | 绝缘电阻 | ≥10,000MΩ |
| Temperature cycling | 温度循环 | ΔR/R±(1%+0.1 Ω) | Thermal shock | 热冲击 | ΔR/R±(1%+0.1Ω) |

Ordering Procedure (Example: HFR 0.75W 10% 10M B/B)

订购方式 (例如: HFR 0.75W 10% 10M B/B)

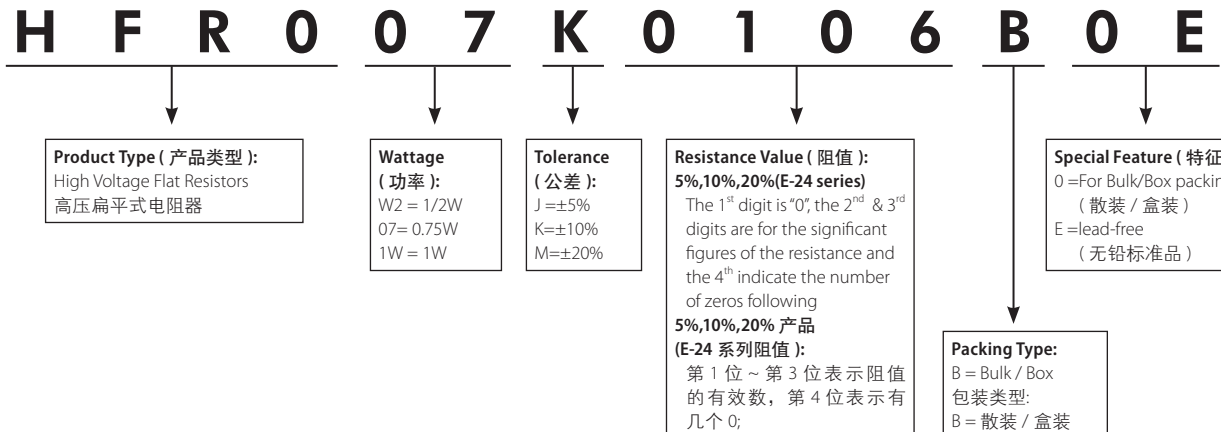

Feature (特性)

- Self-extinguishing 完全不燃性
- Extremely small & sturdy mechanically safe 体积小且坚固安全
- Non-inductive type available 无感也可提供
- Excellent flame & moisture resistance 卓越抗湿性
- Too low or too high values on Wire-wound & Power-film type can be supplied on a case to case basis 过低或过高的阻值，绕线或切割型都可以特别提供

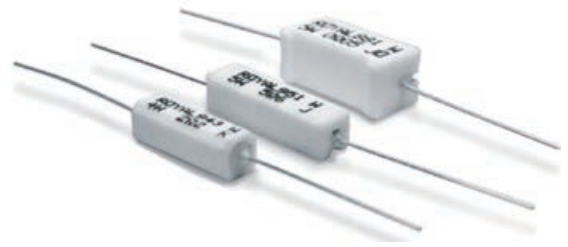

Derating Curve (降功率曲线)

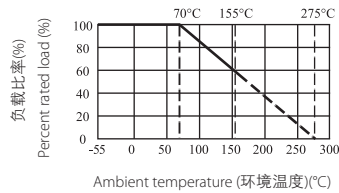

Heat Rise Chart (表面温升)

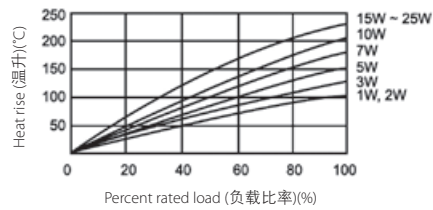

Axial Leaded Type-PRW Series (轴向导线型 -PRW 系列)

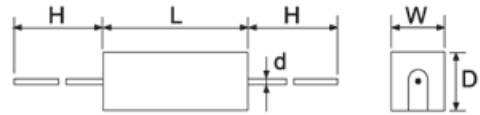

| Part No. 料号 | Type 类型 | Dimension(尺寸)(mm) | | | | | Max. working voltage 最大工作电压 | Max. Overload voltage 最大过负荷电压 | Resistance Range 阻值范围 | |
|-------------|---------|-------------------|------|------|------|--------|-----------------------------|-------------------------------|-----------------------|----------------|
| | | W±1 | D±1 | L±1 | H | d±0.05 | | | Wire-wound 绕线型 | Power Film 膜层型 |
| PRW01W | PRW1W | 6 | 6 | 13.5 | 25±3 | 0.70 | 200V | 400V | 0.1Ω~27Ω | 28Ω~100KΩ |
| PRW02W | PRW2W | 7 | 7 | 18 | 28±5 | 0.70 | 250V | 500V | 0.1Ω~27Ω | 28Ω~120KΩ |
| PRW03W | PRW3W | 8 | 8 | 22 | 32±5 | 0.70 | 300V | 600V | 0.1Ω~39Ω | 40Ω~150KΩ |
| PRW05W | PRW5W | 10 | 9 | 22 | 35±5 | 0.75 | 350V | 700V | 0.1Ω~47Ω | 48Ω~150KΩ |
| PRW07W | PRW7W | 10 | 9 | 35 | 35±5 | 0.75 | 500V | 1000V | 0.1Ω~680Ω | 681Ω~200KΩ |
| PRW0AW | PRW10W | 10 | 9 | 49 | 35±5 | 0.75 | 700V | 1400V | 0.1Ω~910Ω | 911Ω~200KΩ |
| PRW0FW | PRW15W | 12.5 | 11.5 | 49 | 35±5 | 0.75 | 700V | 1400V | 1Ω~1.0KΩ | 1.1KΩ~200KΩ |
| PRW020 | PRW20W | 14.5 | 13.5 | 60 | 35±5 | 0.75 | 750V | 1500V | 2Ω~1.2KΩ | 1.3KΩ~200KΩ |
| PRW025 | PRW25W | 14.5 | 13.5 | 64 | 35±5 | 0.75 | 750V | 1500V | 2Ω~1.2KΩ | 1.3KΩ~200KΩ |

Axial Leaded Type-PRWC Series (轴向导线型 -PRWC 系列)

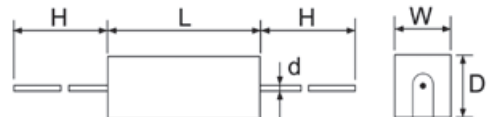

| Part No. 料号 | Type 类型 | Dimension(尺寸)(mm) | | | | | Resistance Range 阻值范围 | |
|-------------|---------|-------------------|-----|-----|------|--------|-----------------------|----------------|
| | | W±1 | D±1 | L±1 | H | d±0.05 | Wire-wound 绕线型 | Power Film 膜层型 |
| PRWC1W | PRWC-1W | 6 | 6 | 12 | 25±3 | 0.70 | 1Ω~27Ω | 28Ω~33KΩ |
| PRWC2W | PRWC-2W | 6 | 6 | 18 | 28±5 | 0.70 | 1Ω~27Ω | 28Ω~33KΩ |
| PRWC3W | PRWC-3W | 6 | 6 | 20 | 28±5 | 0.70 | 1Ω~27Ω | 28Ω~120KΩ |
| PRWC5W | PRWC-5W | 6 | 6 | 25 | 35±5 | 0.75 | 1Ω~200Ω | 201Ω~150KΩ |
| PRWC7W | PRWC-7W | 9 | 9 | 25 | 35±5 | 0.75 | 1Ω~200Ω | 201Ω~150KΩ |

Axial Leaded Type-PRWC Series(轴向导线型 -PRWC 系列)

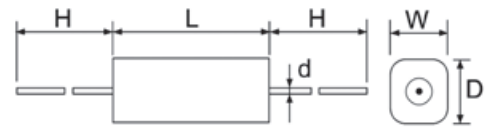

| Part No. 料号 | Type 类型 | Dimension(尺寸)(mm) | | | | | Resistance Range 阻值范围 | |
|----------------|------------|---------------------|-----|-----|-----|--------|-----------------------|----------------|
| | | W±1 | D±1 | L±1 | H±5 | d±0.05 | Wire-wound 绕线型 | Power Film 膜层型 |
| PRC14W | PRWC-1 4W | 6.4 | 6.4 | 20 | 28 | 0.70 | 1Ω~200Ω | 201Ω~100KΩ |
| PRC15W | PRWC-1 5W | 6.4 | 6.4 | 25 | 28 | 0.70 | 1Ω~200Ω | 201Ω~100KΩ |
| PRC16W | PRWC-1 6W | 6.4 | 6.4 | 38 | 35 | 0.75 | 1Ω~200Ω | 201Ω~100KΩ |

Axial Leaded Type-PRWA Series(轴向导线型 -PRWA 系列)

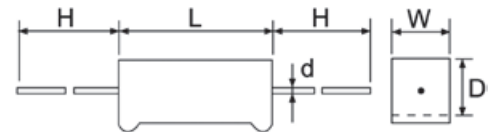

| Part No. 料号 | Type 类型 | Dimension(尺寸)(mm) | | | | | Resistance Range 阻值范围 | |
|----------------|------------|---------------------|-----|-----|-----|--------|-----------------------|----------------|
| | | W±1 | D±1 | L±1 | H±5 | d±0.05 | Wire-wound 绕线型 | Power Film 膜层型 |
| PRWA2W | PRWA-2W | 7 | 7 | 18 | 28 | 0.70 | 0.1Ω~27Ω | 28Ω~120KΩ |
| PRWA5W | PRWA-5W | 10 | 9 | 22 | 35 | 0.75 | 0.1Ω~47Ω | 48Ω~150KΩ |
| PRWA7W | PRWA-7W | 10 | 9 | 35 | 35 | 0.75 | 0.1Ω~680Ω | 681Ω~200KΩ |
| PRWAAW | PRWA-10W | 10 | 9 | 49 | 35 | 0.75 | 0.1Ω~910Ω | 911Ω~200KΩ |

*Max. working voltage&Max. Overloadvoltage Reference to PRW Type 最大工作电压、最大过负荷电压参考 PRW 规格

Radial Leaded Type-PRM Series(立式导线型-PRM系列)

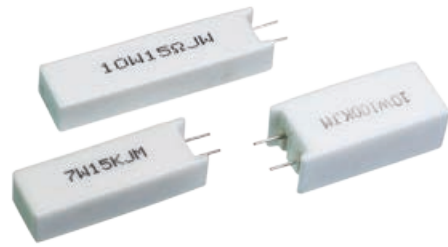
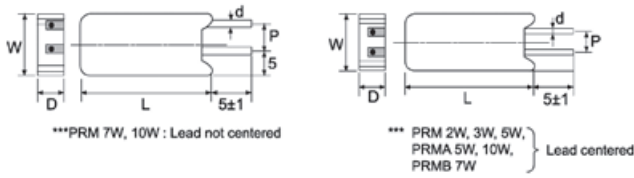

| Part No. 料号 | Type 类型 | Dimension(尺寸)(mm) | | | | | Max. working voltage 最大工作电压 | Max. Overload voltage 最大过负荷电压 | Resistance Range 阻值范围 | |
|----------------|------------|-------------------|-----|-----|-----|---------|--------------------------------|----------------------------------|-----------------------|-------------------|
| | | W±1 | D±1 | L±1 | P±1 | d ±0.05 | | | Wire-wound 绕线型 | Power Film 膜层型 |
| PRM02W | PRM-2W | 11.5 | 7.5 | 20 | 5 | 0.70 | 250V | 500V | 0.1Ω~27Ω | 28Ω~120KΩ |
| PRM03W | PRM-3W | 12.5 | 8.5 | 25 | 5 | 0.70 | 300V | 600V | 0.1Ω~39Ω | 40Ω~150KΩ |
| PRM05W | PRM-5W | 13 | 9 | 25 | 5 | 0.75 | 350V | 700V | 0.1Ω~47Ω | 48Ω~150KΩ |
| PRM07W | PRM-7W | 13 | 9 | 38 | 5 | 0.75 | 500V | 1000V | 0.1Ω~680Ω | 681Ω~200KΩ |
| PRM0AW | PRM-10W | 13 | 9 | 50 | 5 | 0.75 | 700V | 1400V | 0.1Ω~910Ω | 911Ω~200KΩ |
| PRMA5W | PRMA-5W | 13 | 9 | 25 | 7.5 | 0.75 | 350V | 700V | 0.1Ω~47Ω | 48Ω~100KΩ |
| PRMAAW | PRMA-10W | 16 | 12 | 35 | 7.5 | 0.75 | 700V | 1400V | 0.1Ω~560Ω | 561Ω~100KΩ |
| PRMB7W | PRMB-7W | 12.5 | 9 | 38 | 5 | 0.75 | 500V | 1000V | 0.1Ω~680Ω | 681Ω~200KΩ |

Radial Terminal Type-PRMT Series(轴向导线型-PRMT系列)

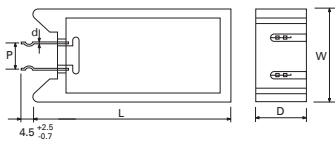

| Part No. 料号 | Type | Dimension(尺寸)(mm) | | | | | Max. working voltage 最大工作电压 | Max. Overload voltage 最大过负荷电压 | Resistance Range 阻值范围 | |
|----------------|---------|-------------------|-------|-----|-----|---------|--------------------------------|----------------------------------|-----------------------|-------------------|
| | | W±1 | D±0.5 | L±1 | P±1 | d ±0.05 | | | Wire-wound 绕线型 | Power Film 膜层型 |
| PRMT15 | PRMT15W | 20 | 13 | 38 | 7.5 | 0.5 | 700V | 1400V | 0.1Ω~560Ω | 561Ω~200KΩ |
| PRMT20 | PRMT20W | 20 | 13 | 45 | 7.5 | 0.4 | 750V | 1500V | | |

Performance Specification (特性)

| | | |
|---------------------------------|--------|---|
| Temperature coefficient | 温度系数 | < 20Ω: ±400PPM; ≥20Ω: ±350PPM |
| Short-time Overload | 短时间过负荷 | ΔR/R±(5%+0.05 Ω), no evidence of mechanical damage(无可见机械损伤) |
| Dielectric withstanding voltage | 绝缘耐压 | no evidence of mechanical damage(无可见机械损伤) |
| Temperature cycling | 温度循环 | ΔR/R±(2%+0.05 Ω),no evidence of mechanical damage(无可见机械损伤) |
| Load life in humidity | 湿度寿命 | Wire-wound type(绕线型):ΔR/R=±5% |
| | | Power Film type(膜层型):<100KΩ:ΔR/R=±5%; ≥100KΩ:ΔR/R=±10% |
| Load life | 负载寿命 | Wire-wound type(绕线型):ΔR/R=±5% |
| | | Power Film type(膜层型):<100KΩ:ΔR/R=±5%; ≥100KΩ:ΔR/R=±10% |

Ordering Procedure (Example: PRW 1W 5% 100Ω B/B)

订购方式 (例如: PRW 1W 5% 100Ω B/B)

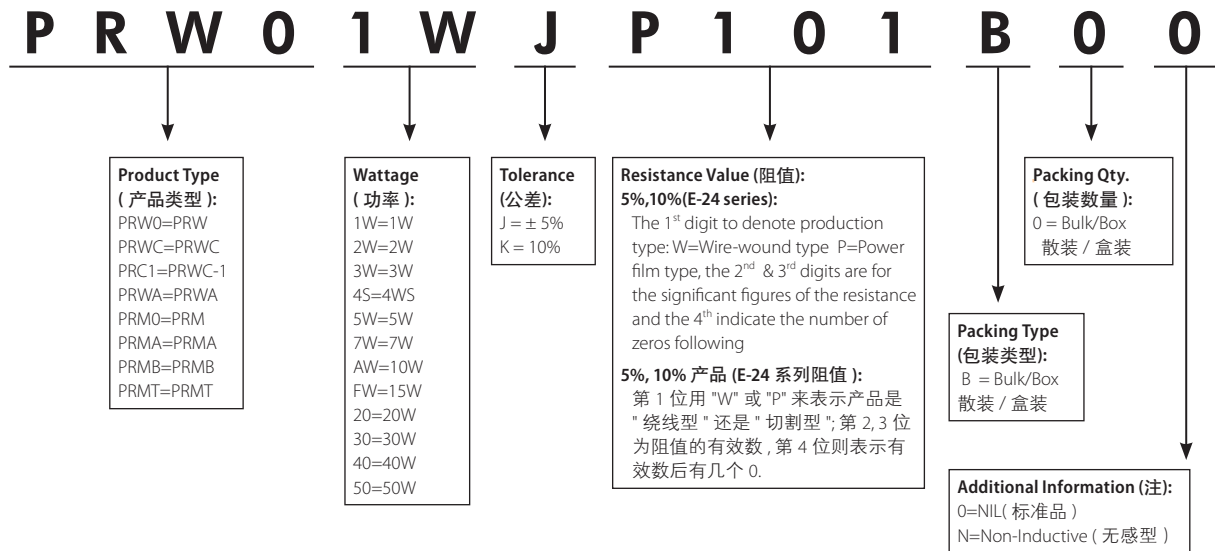

Feature (特性)

- Low inductance 低电感量
- Safety flamerproof construction 耐高温
- Thin & lightweight body save the PCB space considerably 体积小轻薄, 节省PCB空间

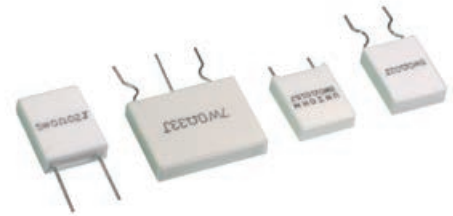

Derating Curve (降功率曲线)

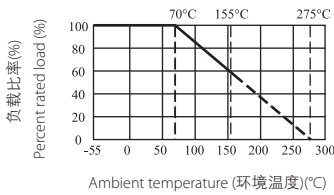

Heat Rise Chart (表面温升)

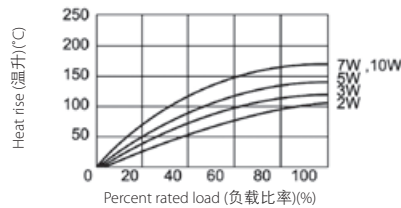

PFAS (Single circuit-S Type) Dimension(mm)

PFAS(单电路-S型)尺寸(mm)

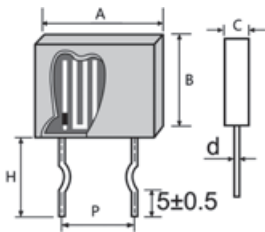

| Type 类型 | A±1.0 | B±1.0 | C±0.5 | d±0.05 | P±1 | H±1 | Resistance Range 阻值范围 (±5%、±10%) |
|---------|-------|-------|-------|--------|-----|-----|----------------------------------|
| PFAS2W | 13 | 8.5 | 5 | 0.75 | 9 | 13 | 0.01Ω~1Ω |
| PFAS3W | 14 | 13.5 | 5 | 0.75 | 10 | 13 | 0.01Ω~1Ω |
| PFAS5W | 14 | 18 | 5 | 0.75 | 10 | 13 | 0.01Ω~1Ω |
| PFAS10W | 26 | 18 | 5 | 0.75 | 20 | 13 | 0.01Ω~3.3Ω |

PFAP (Single circuit-P Type) Dimension(mm)

PFAP(单电路-P型)尺寸(mm)

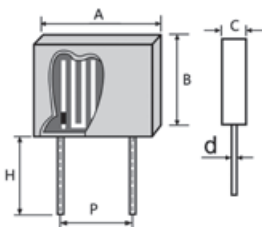

| Type 类型 | A±1.0 | B±1.0 | L±0.5 | d±0.05 | P±1 | H±1 | Resistance Range 阻值范围 (±5%、±10%) |
|---------|-------|-------|-------|--------|-----|-----|----------------------------------|
| PFAP2W | 13 | 8.5 | 5 | 0.75 | 9 | | 0.01Ω~1Ω |
| PFAP3W | 14 | 13.5 | 5 | 0.75 | 10 | 4 | 0.01Ω~1Ω |
| PFAP5W | 14 | 18 | 5 | 0.75 | 10 | 10 | 0.01Ω~1Ω |
| PFAP10W | 26 | 18 | 5 | 0.75 | 20 | | 0.01Ω~3.3Ω |

PFAT (Twin circuit-S Type) Dimension(mm)

PFAT(双电路-S型)尺寸(mm)

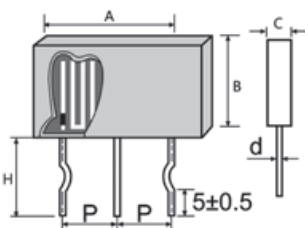

| Type 类型 | A±1.0 | B±1.0 | L±0.5 | d±0.05 | P±1 | H±1 | Resistance Range 阻值范围 (±5%、±10%) |
|---------|-------|-------|-------|--------|-----|-----|----------------------------------|
| PFAT2W | 26 | 9 | 5 | 0.75 | | | 0.05Ω~1Ω |
| PFAT3W | 26 | 13 | 5 | 0.75 | 10 | 13 | 0.05Ω~1Ω |
| PFAT5W | 26 | 18 | 5 | 0.75 | | | 0.05Ω~1Ω |
| PFAT7W | 26 | 20 | 5 | 0.75 | | | 0.1Ω~1Ω |

Performance Specification (特性)

| | | |
|--|--------|---|
| Temperature coefficient | 温度系数 | 0.01Ω~0.1Ω Please contact Uniroyal, ≥0.1Ω:±350PPM |
| Short-time Overload | 短时间过负荷 | ΔR/R≤±(2%+0.05Ω), with no evidence of mechanical damage (无可见机械损伤) |
| Dielectric withstanding voltage | 绝缘耐压 | 2000V |
| Operating temperature | 工作温度范围 | -55° C~+200°C |
| Resistance to soldering heat | 耐焊接热 | ΔR/R±(1%+0.05 Ω) with no evidence of mechanical damage (无可见机械损伤) |
| Temperature cycling | 温度循环 | ΔR/R≤±(5%+0.05Ω), with no evidence of mechanical damage (无可见机械损伤) |
| Solderability | 可焊性 | Min. 95% coverage (最少 95% 覆盖率) |
| Resistance to solvent | 耐溶剂 | No deterioration of protective coating and markings (包封层, 色码完整) |
| Humidity (Steady State) | 恒定湿热 | ΔR/R≤±(5%+0.05Ω), with no evidence of mechanical damage (无可见机械损伤) |
| Load life in humidity | 湿度寿命 | ΔR/R≤±(5%+0.05Ω), with no evidence of mechanical damage (无可见机械损伤) |
| Load life | 负载寿命 | ΔR/R≤±(5%+0.05Ω), with no evidence of mechanical damage (无可见机械损伤) |

Ordering Procedure (Example: PFAS 5W ±5% 0.68Ω B/B)

订购方式 (例如: PFAS 5W ±5% 0.68Ω B/B)

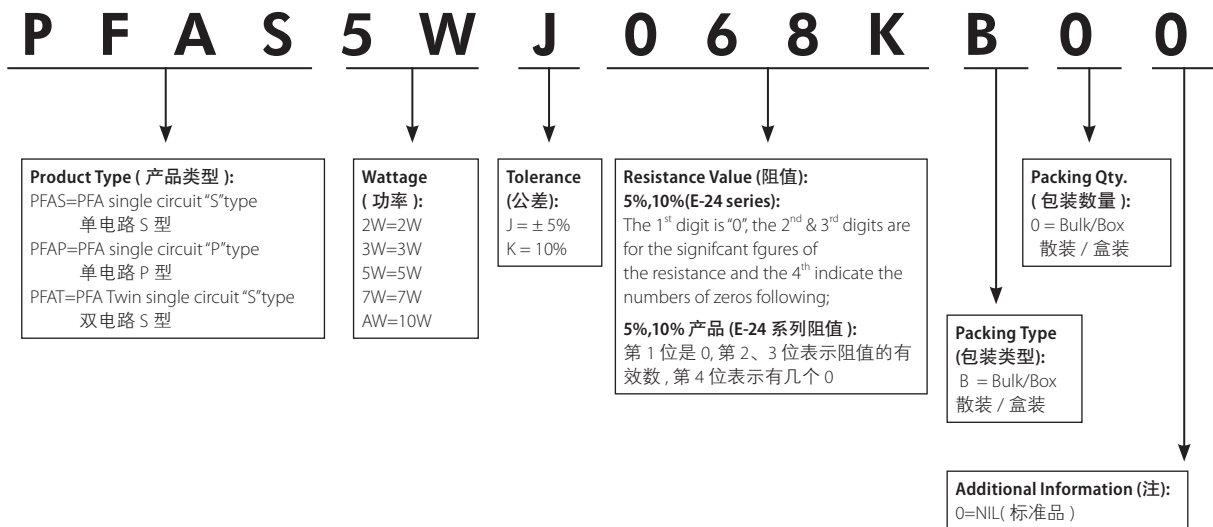

Derating Curve (降功率曲线)

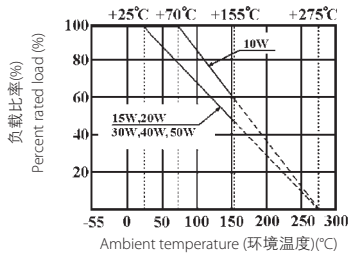

Heat Rise Chart (表面温升)

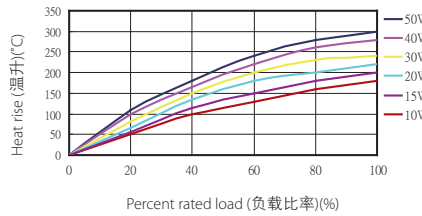

Radial Terminal Type - PRT (With metal mounting bracket)/PRU Series

立式端片型 PRT (带金属安装支架)/PRU

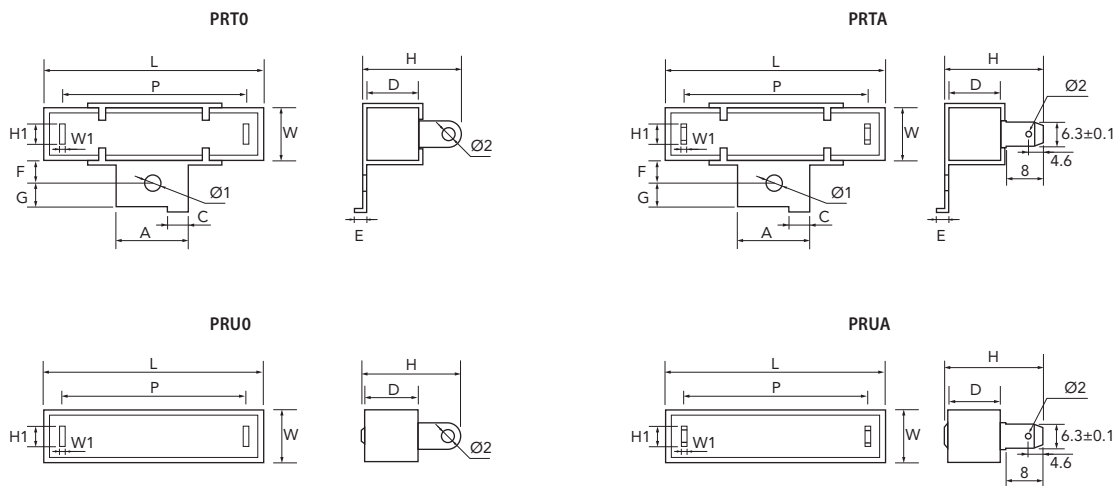

| Type 类型 | W ±1 | D ±1 | L ±1.5 | P ±1 | H ±1 | A ±0.5 | H1 ±0.4 | C ±0.5 | F ±0.5 | G ±0.5 | E ±1 | Ø1 ±0.2 | Ø2 ±0.2 | W1 ±0.08 | Resistance Range 阻值范围 | |
|---------|---------|---------|-----------|---------|---------|-----------|------------|-----------|-----------|-----------|---------|------------|------------|-------------|-----------------------|-------------------|
| | | | | | | | | | | | | | | | Wire-wound 绕线型 | Power Film 膜层型 |
| 10W | PRT0 | 10 | 9 | 48 | 32 | 12 | 5.5 | 3 | 8.7 | 5 | 3 | 4.1 | 2.5 | 0.5 | 1Ω~820Ω | 821Ω~200KΩ |
| | PRU0 | | | | | | | | | | | | | | | |
| 15W | PRT0 | 12.5 | 11.5 | 48 | 32 | 12 | 6.2 | 3 | 8.0 | 6 | 3 | 4.1 | 2.5 | 0.5 | 1Ω~1KΩ | 1.1KΩ~200KΩ |
| | PRU0 | | | | | | | | | | | | | | | |
| 20W | PRT0 | 12.5 | 13.5 | 63 | 44 | 12 | 6.2 | 3 | 10 | 6 | 3 | 4.1 | 2.5 | 0.5 | 2Ω~1.2KΩ | 1.3KΩ~200KΩ |
| | PRU0 | | | | | | | | | | | | | | | |
| 30W | PRT0 | 19 | 19 | 75 | 54 | 18 | 7.6 | 3 | 9.5 | 7.5 | 4 | 4.1 | 3.2 | 0.5 | 3Ω~1.5KΩ | - |
| | PRU0 | | | | | | | | | | | | | | | |
| 40W | PRT0 | 19 | 19 | 90 | 70 | 18 | 7.6 | 3 | 9.5 | 7.5 | 4 | 4.1 | 3.2 | 0.5 | 6Ω~1.5KΩ | - |
| | PRU0 | | | | | | | | | | | | | | | |
| 50W | PRT0 | 19 | 19 | 90 | 70 | 18 | 7.6 | 3 | 9.5 | 7.5 | 4 | 4.1 | 3.2 | 0.5 | 6Ω~1.5KΩ | - |
| | PRU0 | | | | | | | | | | | | | | | |

Performance Specification (特性)

| | | |
|---------------------------------|--------|---|
| Temperature coefficient | 温度系数 | < 20Ω: ±400PPM; ≥20Ω: ±350PPM |
| Short-time Overload | 短时间过负荷 | ΔR/R±(5%+0.05 Ω), no evidence of mechanical damage(无可见机械损伤) |
| Dielectric withstanding voltage | 绝缘耐压 | no evidence of mechanical damage(无可见机械损伤) |
| Temperature cycling | 温度循环 | ΔR/R±(2%+0.05 Ω),no evidence of mechanical damage (无可见机械损伤) |
| Load life in humidity | 湿度寿命 | Wire-wound type(绕线型):ΔR/R=±5% Power Film type(膜层型):<100KΩ:ΔR/R=±5%; ≥100KΩ:ΔR/R=±10% |
| Load life | 负载寿命 | Wire-wound type(绕线型):ΔR/R=±5% Power Film type(膜层型):<100KΩ:ΔR/R=±5%; ≥100KΩ:ΔR/R=±10% |

Ordering Procedure (Example: PRT 50W 5% 100Ω B/B)

订购方式 (例如: PRT 50W 5% 100Ω B/B)

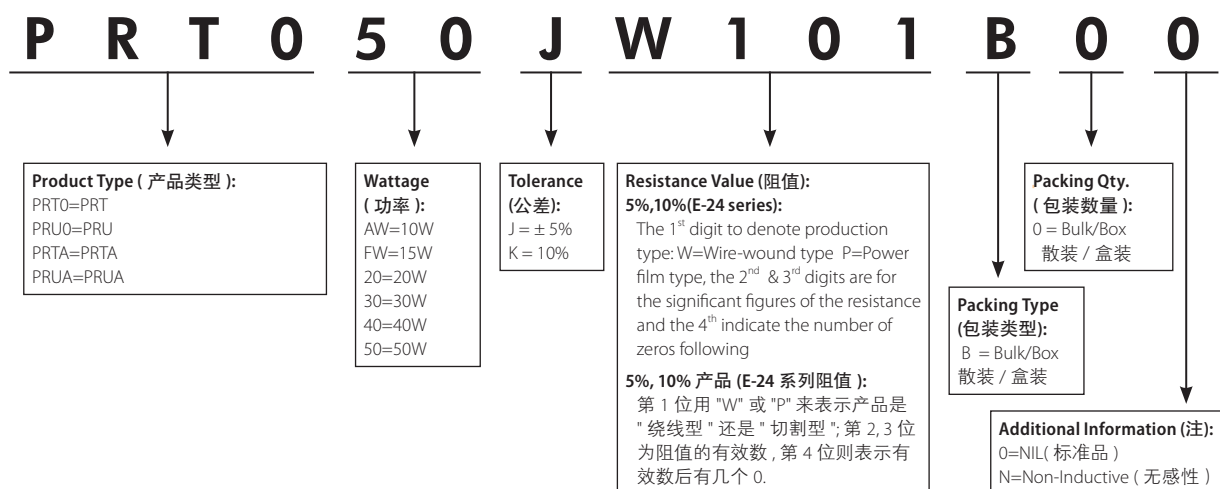

Feature (特性)

- Self-extinguishing 完全不燃性
- Extremely small & sturdy mechanically safe 体积小且坚固安全
- Excellent flame & moisture resistance 卓越抗湿性
- Too low or too high values on Wire-wound & Power-film type can be supplied on a case to case basis 过低或过高的阻值，绕线或切割型都可以特别提供



Radial Terminal Type-PRVA Series

(立式端片型-PRVA系列)

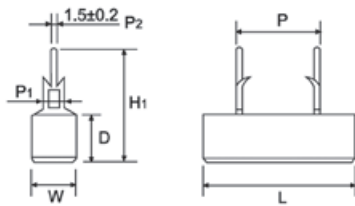

Radial Terminal Type - PRVB Series

立式端片型-PRVB系列

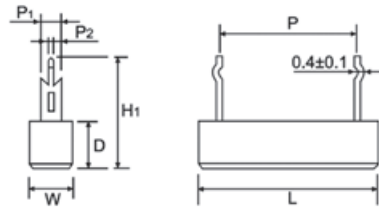

| 类型 Type | W±1 | D±1 | L±1 | P±1 | Resistance Range 阻值范围 |
|----------------------|------|------|-------|--------|-----------------------|
| PRVA-3W PRVB-3W | 10 | 9 | 22 | 9.5 | 0.1Ω~150KΩ |
| PRVA-5W PRVB-5W | 10 | 9 | 27/25 | 15/9.5 | 0.1Ω~200KΩ |
| PRVA-7W PRVB-7W | 10 | 9 | 35 | 22 | 0.1Ω~200KΩ |
| PRVA-10W PRVB-10W | 10 | 9 | 48 | 35/32 | 1Ω~200KΩ |
| PRVA-15W PRVB-15W | 12.5 | 11.5 | 48 | 32 | 1Ω~200KΩ |
| PRVA-20W PRVB-20W | 12.5 | 13.5 | 63 | 42 | 1Ω~200KΩ |

Radial Terminal Type-PRZ Series

(立式端片型-PRZ系列)

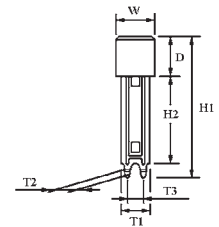
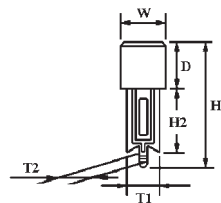
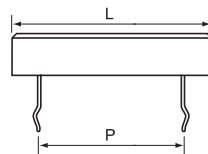

| Type | W±1 | D±1 | L | P±1.5 | Resistance Range 阻值范围 |
|-----------------------------------|------|------|---------|--------|-----------------------|
| PRZA-1/PRZA-2/PRZC/PRZD 3 W | 10 | 9 | 22±1 | 9.5 | 0.1~150KΩ |
| PRZA-1/PRZA-2/PRZA-3/PRZC/PRZD 5W | 10 | 9 | 25/27±1 | 9.5/15 | 0.1Ω~200KΩ |
| PRZA-1/PRZA-2/PRZC/PRZD 7W | 10 | 9 | 35±1 | 22 | 0.1Ω~200KΩ |
| PRZA-1/PRZA-2/PRZC/PRZD 10W | 10 | 9 | 48±1.5 | 32/35 | 1Ω~200KΩ |
| PRZA-1/PRZA-2/PRZC/ 15W | 12.5 | 11.5 | 48±1.5 | 32 | 1KΩ~200KΩ |
| PRZA-1/PRZA-2/PRZC/ 20W | 12.5 | 13.5 | 63±1.5 | 42/45 | 1KΩ~200KΩ |

* detailed information please contact the factory 详细信息请联系工厂

Feature (特性)

- Self-extinguishing 完全不燃性
- Extremely small & sturdy mechanically safe 体积小且坚固安全
- Excellent flame & moisture resistance 卓越抗湿性
- Too low or too high values on Wire-wound & Power-film type can be supplied on a case to case basis 过低或过高的阻值，绕线或切割型都可以特别提供

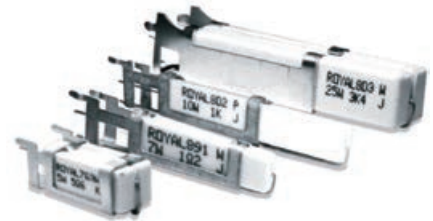

Radial Leaded Type-PRS Series(立式导线型-PRS系列)

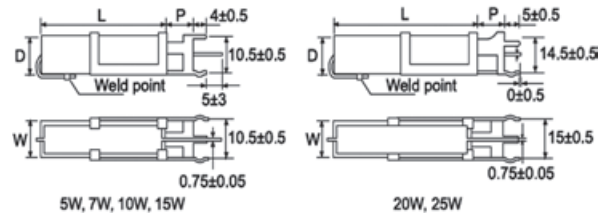

| Part No. 料号 | Type | Dimension(尺寸)(mm) | | | | | Resistance Range 阻值范围 |
|----------------|---------|---------------------|------|-----|-----|---------|-----------------------|
| | | W±1 | D±1 | L±1 | P±1 | d ±0.05 | |
| PRS05W | PRS-5W | 10 | 9 | 22 | 5 | 0.75 | 0.1Ω~150KΩ |
| PRS07W | PRS-7W | 10 | 9 | 35 | 10 | 0.75 | 0.1Ω~200KΩ |
| PRS0AW | PRS-10W | 10 | 9 | 45 | 10 | 0.75 | 0.1Ω~200KΩ |
| PRS0FW | PRS-15W | 12.5 | 13.5 | 49 | 11 | 0.75 | 0.1Ω~200KΩ |
| PRS020 | PRS-20W | 14.5 | 13.5 | 60 | 10 | 0.75 | 0.1Ω~200KΩ |
| PRS025 | PRS-25W | 14.5 | 13.5 | 64 | 10 | 0.75 | 0.1Ω~200KΩ |

Radial Terminal Type Resistors (立式端片型电阻器)

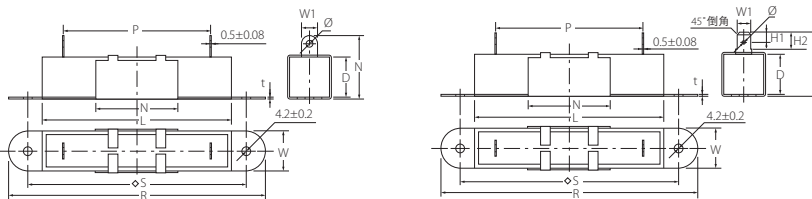

| Type 类型 | W±1 | D±1 | L±1.5 | H±1 | Resistance Range 阻值范围 |
|--------------|------|------|-------|---------|-----------------------|
| PRTC/PRTD10W | 10 | 9 | 48 | 18/19 | 1Ω~200KΩ |
| PRTC/PRTD15W | 12.5 | 11.5 | 48 | 21/23.5 | 1Ω~200KΩ |
| PRTC/PRTD20W | 12.5 | 13.5 | 63 | 21/25 | 2KΩ~200KΩ |
| PRTC/PRTD30W | 19 | 19 | 75 | 32/30 | 3Ω~1.5KΩ |
| PRTC/PRTD40W | 19 | 19 | 90 | 32/30 | 6Ω~1.5KΩ |
| PRTC/PRTD50W | 19 | 19 | 90 | 32/30 | 6Ω~1.5KΩ |

Resistors of Capacitor Voltage Balance (电容电压平衡电阻器)

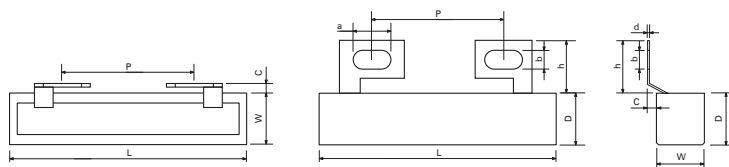

| Type 类型 | Dimension(尺寸)(mm) | | | | Resistance Range 阻值范围 |
|---------|-----------------------|-------|-------|-------|-----------------------|
| | W±1.0 | D±1.5 | L±1.5 | P±1.5 | |
| PRTM4W | 12.5 | 12.5 | 48.0 | 27.0 | 1.3KΩ~200KΩ |
| PRTM7W | 12.5 | 12.5 | 63.0 | 27.0 | |
| PRTM20W | 12.5 | 13.5 | 63.0 | 35.0 | |

* detailed information please contact the factory 详细信息请联系工厂

Feature (特性)

- Square porcelain tube 方形瓷管外壳
- Excellent insulation and moisture resistance 优良的绝缘性和耐湿性
- Winding process, good resistance to load 绕线工艺, 良好的耐负荷能力
- Application: Power supply of frequency converter 应用: 变频器的电源



PHF1、PHF2、PHF3 Series

| Type 类型 | H±1.5 | H1±0.5 | D±0.5 | D1±0.5 | L | Resistance Range 阻值范围 |
|--------------------|-------|--------|-------|--------|------|-----------------------|
| PHF1/PHF2 4W | - | 8.5 | - | 7.5 | 20±1 | 1Ω~1KΩ |
| PHF1/PHF2 5W | - | 8.5 | - | 7.5 | 25±1 | 1Ω~2.2KΩ |
| PHF1/PHF2 7W | - | 9.5 | - | 7.5 | 38±1 | 1Ω~6.2KΩ |
| PHF1/PHF2 9W | 10 | - | 9 | - | 38±1 | 1Ω~6.2KΩ |
| PHF1/PHF2/PHF3 11W | 10 | - | 9 | - | 50±1 | 1Ω~6.2KΩ |
| PHF1/PHF2/PHF3 17W | 10 | - | 9 | - | 75±2 | 1Ω~10KΩ |

PHF1type 卧式1型

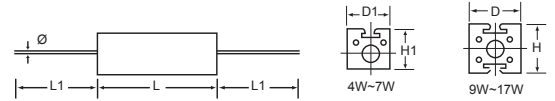

PHF2type 卧式2型



PHF3 type 卧式3型

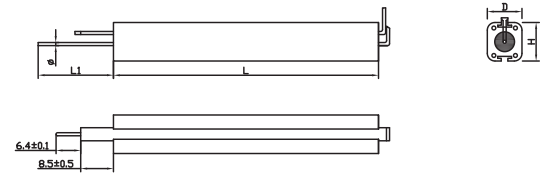

PRWI Series

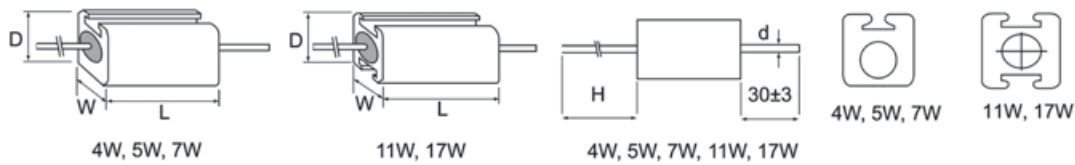

| Type 类型 | W±1 | D | L±1 | H±1 | d±0.05 | Resistance Range 阻值范围 |
|----------|-----|--------|-----|-----|--------|-----------------------|
| PRWI 4W | 7.0 | 8±1 | 20 | 56 | 0.75 | 0.1Ω~6.8KΩ |
| PRWI 5W | 7.5 | 8.5±1 | 25 | 60 | 0.75 | 0.1Ω~6.8KΩ |
| PRWI 7W | 7.0 | 8±1 | 38 | 70 | 0.75 | 0.33Ω~22KΩ |
| PRWI 11W | 9.0 | 10±1.5 | 50 | 85 | 0.75 | 0.33Ω~22KΩ |
| PRWI 17W | 9.0 | 10±1.5 | 75 | 110 | 0.75 | 1Ω~39KΩ |

* detailed information please contact the factory 详细信息请联系工厂

Feature (特性)

- With Aluminum Shell for a good heat dissipation, suitable for board mount 铝外壳散热性能好，适用于散热板安装
- Thin & lightweight body with big power rating 本体小而轻，功率大
- Application: Power Supply, Adapter, Machine 应用：设备电源类

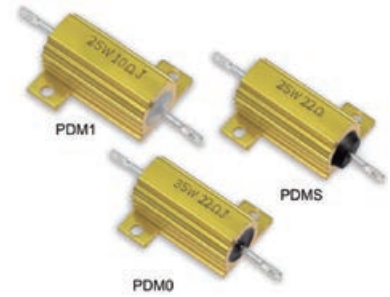

Derating Curve (降功率曲线)

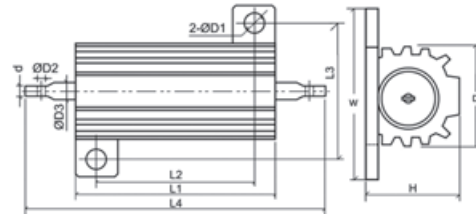
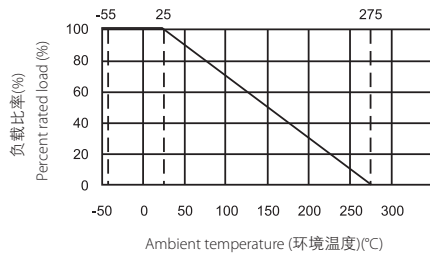

PDM5W~50W

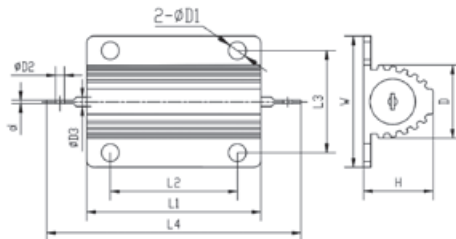

(PDM1 75W、100W)

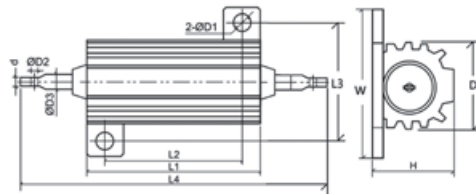

(PDM5 25W~50W)

| Type | L1±1 | L2 | L3 | L4±1.5 | W±1 | H±1 | D±1 | d±0.2 | D1 | D2±0.5 | D3 | Resistance range 阻值范围 | Special high value 特殊最高值 |
|------------|------|----------|----------|--------|----------|------|------|-------|--------------|--------|---------|--------------------------|-----------------------------|
| PDM 5W | 15.5 | 11±0.5 | 12±0.5 | 32.5 | 16±0.5 | 8.0 | 8.0 | 0.3 | 2.0+0.5/-0.2 | 1.3 | 1±0.05 | 0.5Ω~1KΩ | 1.8KΩ |
| PDM10W | 20.5 | 15.2±0.5 | 17.2±0.5 | 40.5 | 22.3±0.5 | 12.2 | 11.0 | 0.8 | 2.5+0.5/-0.2 | 2.0 | 2±0.1 | 1Ω~1.5KΩ | 5KΩ |
| PDM25W | 28.0 | 18.2±0.5 | 20.2±0.5 | 45.5 | 30.3±0.5 | 16.0 | 13.5 | 0.8 | 3.0+0.5/-0.2 | 2.0 | 2±0.1 | 5.1Ω~8.2KΩ | 12KΩ |
| | 28.0 | 18±0.5 | 19.0±0.5 | 49.0 | 27±1 | 14.0 | 13.5 | 0.8 | 4+0.5/-0.2 | / | 2±0.1 | 5.1Ω~8.2KΩ | 12KΩ |
| PDM35W | 34.5 | 24.2±0.5 | 20.2±0.5 | 56.5 | 30±0.5 | 16.3 | 16.3 | 0.8 | 3.0+0.5/-0.2 | 2.0 | 2±0.1 | 5.1Ω~8.2KΩ | 15KΩ |
| PDM50W | 50.5 | 40.2±0.5 | 20.2±0.5 | 75.0 | 30.3±0.5 | 15.7 | 15.5 | 0.8 | 3.0+0.5/-0.2 | 2.0 | 2±0.1 | 5.1Ω~20KΩ | 35KΩ |
| | 50.0 | 40±1 | 21.5±0.5 | 78.5 | 30±1 | 16.0 | 15.5 | 0.8 | 3.5±0.5 | / | 2±0.1 | 5.1Ω~20KΩ | 35KΩ |
| PDM5 25W | 28.0 | 18±0.5 | 19±1 | 49.0 | 27±0.5 | 14.0 | 13.5 | 0.8 | 4±0.5 | 2.0 | 2±0.1 | 5.1Ω~8.2KΩ | 22KΩ |
| PDM5 50W | 50.0 | 40±0.5 | 21.5±1 | 75.0 | 30±0.5 | 16.0 | 15.5 | 0.8 | 3.5±0.5 | 2.0 | 2±0.1 | 5.1Ω~20KΩ | 35KΩ |
| PDM-1 75W | 66.0 | 36±0.5 | 37±1 | 88.0 | 47.5±1 | 26.0 | 27.0 | 1.1 | 4.5±0.5 | 2.0 | 2.3±0.2 | 1Ω~20KΩ | - |
| PDM-1 85W | 75.5 | 40±0.5 | 20.5±1 | 100 | 29±1 | 15.5 | 15.5 | 0.8 | 3.5±0.5 | 2.0 | 2±0.1 | 1Ω~20KΩ | - |
| PDM-1 100W | 98.0 | 72±1 | 37±1 | 120 | 48±1 | 26.0 | 27.0 | 0.8 | 4.5±0.5 | 2.0 | 2±0.1 | 1Ω~20KΩ | - |

* detailed information please contact the factory 详细信息请联系工厂

Feature (特性)

- Anti-vibration, high stability 优异的抗震性和稳定性
- Excellent transient current impact capability, suitable for the start of the inverter under harsh conditions 优良的瞬间电流冲击能力，适合变频器严苛条件下的启动
- Application: Frequency Conversion Equipment, such as Elevator, Freezer, Crane, Lift etc. 应用: 各类变频设备中, 如电梯, 冷柜, 起重机, 升降机等



Derating Curve (降功率曲线)

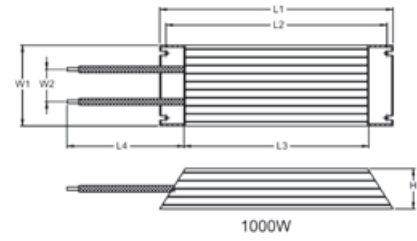
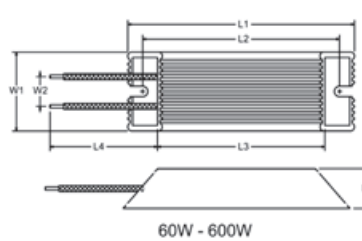
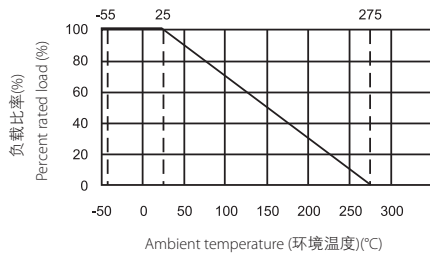

| Type 类型 | L1±2 | L2±2 | L3±2 | L4±10 | W1±2 | W2±5 | H±2 | Resistance Range 阻值范围 |
|-----------|------|------|------|-------|------|------|-----|-----------------------|
| HEWR60W | 115 | 100 | 80 | 190 | 40 | 15 | 20 | 2Ω~2.5KΩ |
| HEWR80W | 140 | 125 | 105 | 200 | 40 | 15 | 20 | 1Ω~3KΩ |
| HEWR100W | 140 | 125 | 100 | 240 | 60 | 25 | 30 | 1Ω~4KΩ |
| HEWR100WS | 165 | 150 | 125 | 240 | 40 | 15 | 20 | 1Ω~4KΩ |
| HEWR120W | 190 | 175 | 150 | 240 | 40 | 15 | 20 | 1Ω~5KΩ |
| HEWR150W | 215 | 200 | 175 | 240 | 40 | 15 | 20 | 1Ω~6KΩ |
| HEWR200W | 165 | 150 | 125 | 255 | 60 | 25 | 30 | 1Ω~7KΩ |
| HEWR300W | 215 | 200 | 175 | 255 | 60 | 25 | 30 | 1Ω~8KΩ |
| HEWR400W | 265 | 250 | 225 | 255 | 60 | 25 | 30 | 0.5Ω~10KΩ |
| HEWR500W | 335 | 320 | 295 | 255 | 60 | 25 | 30 | 0.5Ω~12KΩ |
| HEWR600W | 335 | 320 | 295 | 255 | 60 | 25 | 30 | 0.5Ω~12KΩ |
| HEWR1000W | 400 | 385 | 340 | 255 | 100 | 25 | 50 | 1Ω~15KΩ |

HBWR Lead Type-HBWR 引线型

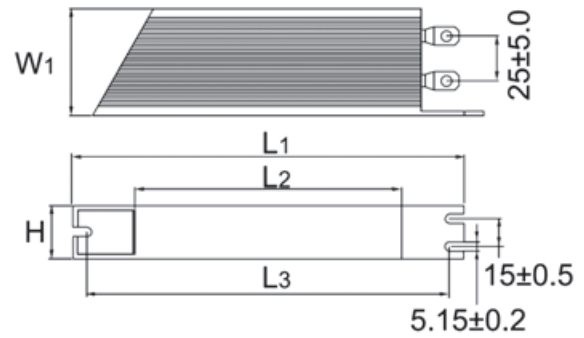

| Type 类型 | L1±2 | L2±2 | L3±2 | W1±2 | H±2 | Resistance Range 阻值范围 |
|----------|------|------|------|------|-----|-----------------------|
| HBWR200W | 190 | 160 | 165 | 30 | 60 | 1Ω~7KΩ |
| HBWR300W | 240 | 210 | 215 | 30 | 60 | 1Ω~8KΩ |
| HBWR400W | 290 | 260 | 265 | 30 | 60 | 0.5Ω~10KΩ |
| HBWR500W | 360 | 330 | 335 | 30 | 60 | 0.5Ω~12KΩ |
| HBWR600W | 360 | 330 | 335 | 30 | 60 | 0.5Ω~12KΩ |

Performance Specification (特性)

| | | |
|---------------------------------|--------|---|
| Temperature coefficient | 温度系数 | <20Ω:±400PPM; ≥20Ω:±350PPM |
| Short-time Overload | 短时间过负荷 | ΔR/R≤±(5%+0.05Ω), with no evidence of mechanical damage (无可见机械损伤) |
| Dielectric withstanding voltage | 绝缘耐压 | No evidence of flashover, mechanical damage.(无击穿、飞弧及可见机械损伤) |
| Temperature cycling | 温度循环 | ΔR/R≤±(2%+0.05Ω), with no evidence of mechanical damage (无可见机械损伤) |
| Humidity (Steady State) | 恒定湿热 | ΔR/R≤±(5%+0.05Ω), with no evidence of mechanical damage (无可见机械损伤) |
| Load life in humidity | 湿度寿命 | ΔR/R≤±(5%+0.05Ω), with no evidence of mechanical damage (无可见机械损伤) |
| Load life | 负载寿命 | ΔR/R≤±(5%+0.05Ω), with no evidence of mechanical damage (无可见机械损伤) |

Ordering Procedure (Example: HEWR200W ±5% 10Ω B/B)

订购方式 (例如: HEWR200W±5% 10Ω B/B)

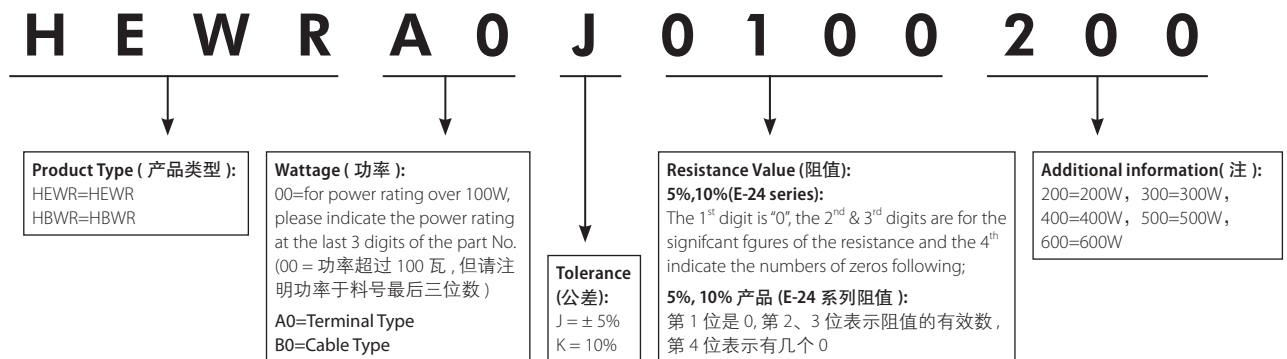

New/Old Part.no Contrast (新旧料号对照)

| New Part.no 新料号 | Old Part.no 旧料号 |
|-----------------|-----------------|
| HEWR**J***** | HPAR**J***** |

Feature (特性)

- Multi-terminal types & variable types available 多端子和多可调阻方式都可提供
- Small in size but capable of carrying high power load 小体型负载大功率
- Resistance value unchanged after long use, good resistivity to short time overload 长年使用不变阻值，短时间过负荷表现良好
- High resistivity to heat, small resistance temperature coefficient and the change in resistance with temperature being linear 抗热，温度系数低，温度变化小
- Too low or high ohmic value can be supplied on a case to case basis 超低或超高阻值都可特别提供
- Adjustable & Multi-Resistor type is available 可调型与多阻型可提供
- Non-Inductive type is available 可提供无感型

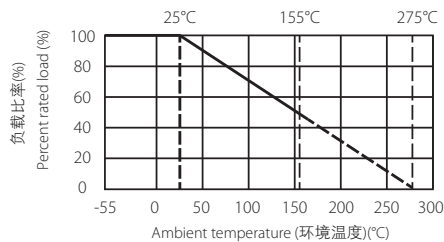

Derating Curve (降功率曲线)

Power Wire-wound Resistors-QH&QL Type

功率绕线型 -- QH&QL Type

QH Type (QH 型)

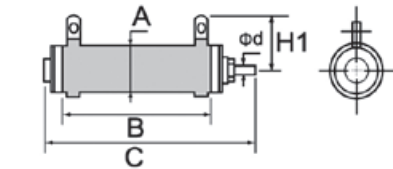

(QH Type 20W~40W)

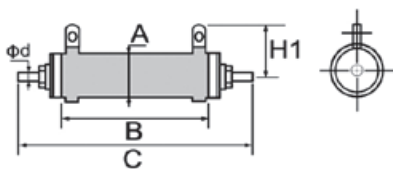

(QH Type 50W~600W)

QL Type (QL 型)

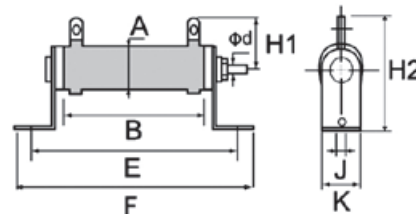

(QL Type 20W~40W)

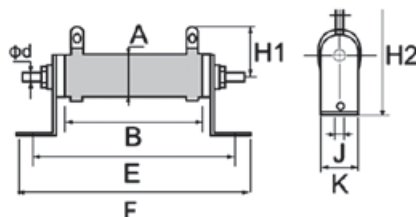

(QL Type 50W~600W)

| Type 类型 | Dimension (尺寸)(mm) | | | | | | | | | | Resistance range 阻值范围 |
|-----------|--------------------|-------|-----|-------|-------|------|------|-----|-----|---------|-----------------------|
| | A±2 | B | C±2 | E | F | H1±2 | H2±2 | J±1 | K±1 | Φd±0.05 | |
| QH/QL20W | 22 | 50±2 | 70 | 75±2 | 102±2 | 25 | 50 | 5 | 19 | 4 | 1Ω~10KΩ |
| QH/QL25W | 22 | 60±2 | 81 | 84±2 | 110±2 | 25 | 50 | 5 | 19 | 4 | 2Ω~12KΩ |
| QH/QL30W | 22 | 75±2 | 95 | 99±2 | 126±2 | 25 | 50 | 5 | 19 | 4 | 2Ω~15KΩ |
| QH/QL40W | 22 | 90±2 | 112 | 114±2 | 141±2 | 25 | 50 | 5 | 19 | 4 | 2Ω~20KΩ |
| QH/QL50W | 30 | 75±2 | 110 | 103±2 | 133±2 | 34 | 64 | 6.3 | 27 | 5 | 3Ω~25KΩ |
| QH/QL60W | 30 | 90±2 | 126 | 117±2 | 147±2 | 34 | 64 | 6.3 | 27 | 5 | 3Ω~30KΩ |
| QH/QL80W | 30 | 115±2 | 150 | 143±2 | 173±2 | 34 | 64 | 6.3 | 27 | 5 | 3Ω~40KΩ |
| QH/QL100W | 30 | 140±2 | 173 | 166±2 | 197±2 | 34 | 64 | 6.3 | 27 | 5 | 3Ω~50KΩ |
| QH/QL120W | 30 | 165±2 | 200 | 193±2 | 223±2 | 34 | 64 | 6.3 | 27 | 5 | 4Ω~60KΩ |
| QH/QL150W | 30 | 195±2 | 230 | 224±2 | 254±2 | 34 | 64 | 6.3 | 27 | 5 | 4Ω~70KΩ |
| QH/QL200W | 30 | 254±2 | 289 | 282±2 | 312±2 | 34 | 64 | 6.5 | 27 | 5 | 5Ω~100KΩ |
| QH/QL300W | 42 | 254±2 | 292 | 285±2 | 332±2 | 45 | 87 | 6.5 | 39 | 5 | 8Ω~150KΩ |
| QH/QL400W | 42 | 330±3 | 364 | 364±3 | 410±3 | 45 | 87 | 6.5 | 39 | 5 | 10Ω~200KΩ |
| QH/QL600W | 42 | 420±3 | 458 | 451±3 | 498±3 | 45 | 87 | 6.5 | 39 | 5 | 10Ω~200KΩ |

* detailed information please contact the factory 详细信息请联系工厂

Power Ribbon Wire-wound Resistors-QR&QRZG Type

功率合金带绕线型 -QR&QRZG Type

QR Type (QR 型)

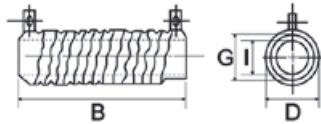

QRZG Type (QRZG 型)

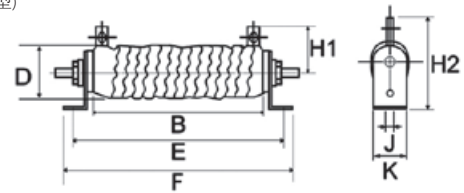

| Type 类型 | Dimension (尺寸)(mm) | | | | | | | | | | Resistance range 阻值范围 |
|--------------|--------------------|-----|-------|-------|-----|------|------|-----|-----|-----|--------------------------|
| | B | D±4 | E | F | G±2 | H1±2 | H2±2 | I±2 | J±1 | K±1 | |
| QR/QRZG120W | 115±2 | 36 | 143±2 | 173±2 | 28 | 34 | 64 | 16 | 6.3 | 27 | 0.2Ω~4Ω |
| QR/QRZG150W | 140±2 | 36 | 166±2 | 197±2 | 28 | 34 | 64 | 16 | 6.3 | 27 | 0.3Ω~5Ω |
| QR/QRZG180W | 165±2 | 36 | 193±2 | 223±2 | 28 | 34 | 64 | 16 | 6.3 | 27 | 0.3Ω~6Ω |
| QR/QRZG225W | 195±2 | 36 | 224±2 | 254±2 | 28 | 34 | 64 | 16 | 6.3 | 27 | 0.4Ω~8Ω |
| QR/QRZG300W | 254±2 | 36 | 282±2 | 312±2 | 28 | 34 | 64 | 16 | 6.3 | 27 | 0.5Ω~10Ω |
| QR/QRZG450W | 254±2 | 48 | 285±2 | 332±2 | 40 | 45 | 87 | 25 | 6.5 | 39 | 0.8Ω~15Ω |
| QR/QRZG600W | 330±3 | 48 | 364±3 | 410±3 | 40 | 45 | 87 | 25 | 6.5 | 39 | 1Ω~20Ω |
| QR/QRZG750W | 300±3 | 58 | 332±3 | 384±3 | 50 | 57 | 102 | 34 | 8 | 48 | 1Ω~75Ω |
| QR/QRZG1000W | 390±3 | 58 | 423±3 | 475±3 | 50 | 57 | 102 | 34 | 8 | 48 | 1Ω~100Ω |

Ordering Procedure (Example: QRZG 225W ±5% 1.8Ω B/B)

订购方式 (例如: QRZG 225W ±5% 1.8Ω B/B)

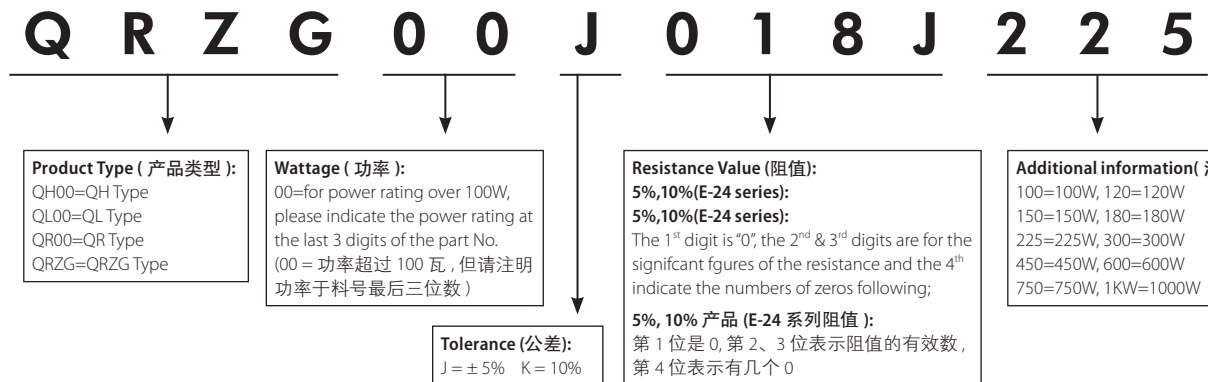

Bilateral Cement Fixed Resistor-BCR Type

双体水泥固定电阻器-BCR型

- Small size & sturdy mechanically safe 尺寸小、机械性能安全
- High safety standard 安全系数高
- Application: Automobile and motorcycle 应用: 汽车、摩托车

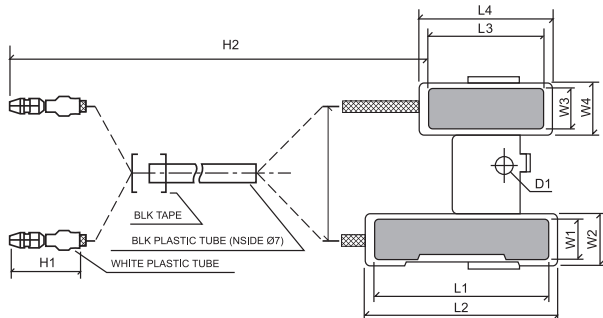
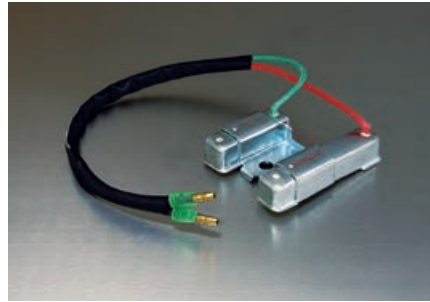

| Type 类型 | L1±0.5 | L2±1 | L3±0.5 | L4±1 | W1±0.5 | W2±1 | W3 | W4±1 | H1 Max. | H2+10/-0 | D1+0.5/-0 |
|-----------|--------|------|--------|------|--------|------|--------|------|---------|----------|-----------|
| BCR20W+5W | 64 | 66 | 42 | 44 | 13 | 15 | 13±0.5 | 15 | 30 | 250 | 6.5 |

Thermal Fuse Wire-wound Resistors-ASSY Type

热熔保险丝型绕线电阻器-ASSY型

- High quality non-flame coating 高品质阻燃性涂装
- Self fusing 自熔断
- High current load and pulse capacity 高电流的负荷和脉冲能力
- Application: Automobile 应用: 汽车

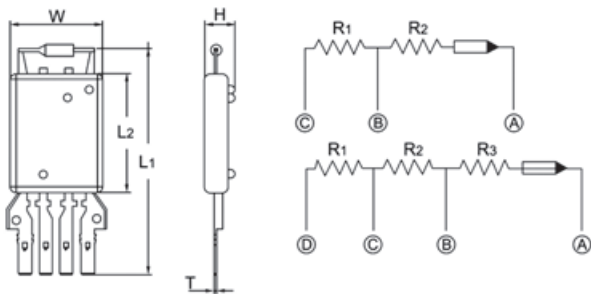

Derating Curve (降功率曲线)

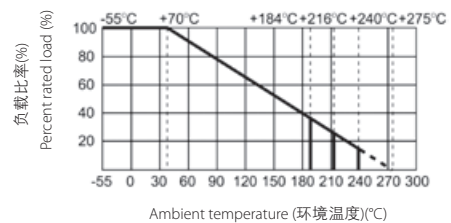

| Type 类型 | L1±3 | L2±3 | W±3 | H(MAX) | T±0.2 | Resistance Range 阻值范围 |
|-----------------|------|------|-----|--------|-------|-----------------------|
| ASSY-4 Terminal | 74 | 43 | 39 | 13 | 0.8 | 0.1Ω~10Ω |
| ASSY-5 Terminal | 80 | 43 | 34 | 13 | 0.8 | 0.1Ω~10Ω |

* detailed information please contact the factory 详细信息请联系工厂

High Power Wire-wound Flat Aluminum Shell Fixed Resistors-HFWR Type

高功率绕线扁平铝壳电阻器 -HFWR 型

- Completely flame-retardant material 完全阻燃的材料
- Anti-vibration, high stability 优异的抗震性和稳定性
- Flat structure with great saving space 扁平式结构极大的节约空间
- Wire-wound process, good resistance to current impact
绕线工艺，良好的耐电流冲击能力
- Application: Overload current protection of lithium battery pack in the start of new energy vehicle
应用：新能源汽车启动时锂电池组的过载电流保护

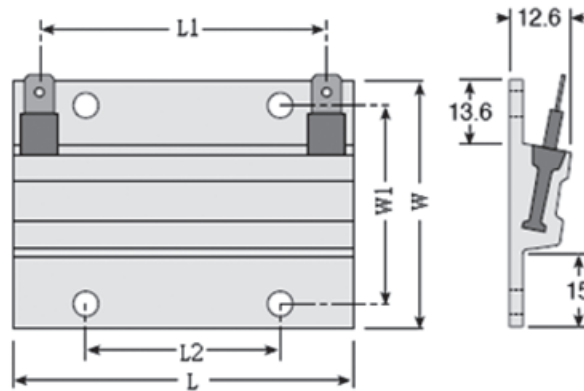

| Type 类型 | L±1.0 | L1±0.5 | L2±0.3 | W±0.3 | W1±0.3 |
|----------|-------|--------|--------|-------|--------|
| HFWR90W | 70 | 53 | 39.7 | 51 | 41 |
| HFWR330W | 280 | 263 | 2*100 | 51 | 41 |

Cement Thermal Fusible Resistors

水泥热熔保险丝电阻器

- Self-extinguishing 自熄灭
- Excellent flame & moisture resistance 优异的阻燃性和抗湿性
- Extremely small & sturdy mechanically safe 体积小且坚固安全
- Non-inductive type available 无感也可提供
- Circuit protection applied to industrial and motor control 应用于工业和马达控制的电路保护
- Old Part.NO: PF2A~PF10D Series 旧料号PF2A~PF10D系列

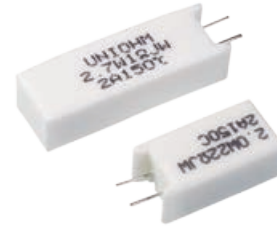

| Type 类型 | FTR2~FTR10 |
|---|-------------|
| Thermal Cut-Off Temp. 动作温度 | 98°C ~235°C |
| Rated current 额定电流 | 2A&10A |
| Rated voltage 额定电压 | AC 250V |
| Wire-wound Resistance Range 阻值范围 (±5%、±10%) | 0.22Ω~1.8KΩ |

Vertical Type Shrapnel Fuse Resistors - PHF0 Type

立式弹片型保险丝电阻 - PHF0 型

- Elastic sheet metal, solder dot fuse, reliable circuit cut off function 弹性金属片，锡点熔断型，可靠的电路切断功能
- Fusing Temperature 220±20°C 熔断温度220±20°C
- Application: Over temperature protection of industrial power supply 应用：工业电源部分的超温保护

| Type 类型 | L±1.0 | W±1.0 | H±1 | L1±3 | L2±1.5 | L3±0.5 | C±0.1 | e±0.1 | Φd±0.05 |
|---------|-------|-------|------|------|--------|--------|-------|-------|---------|
| PHF-2W | 25.0 | 9.0 | 10.0 | 38.0 | 13.0 | 4.5 | 3.0 | 0.9 | 0.75 |

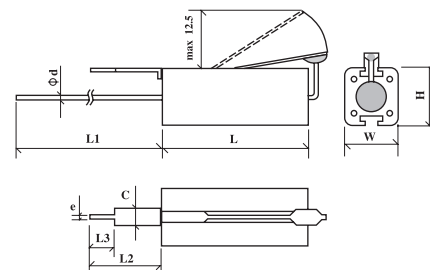

Array Type Cement Temperature Fusing Resistors - TFRC Type

排列式水泥温度保险丝电阻器 - TFRC 型

- Multi lead arrange encapsulation & space saving 多引线排列封装、节约空间
- Excellent flame & moisture resistance 良好的阻燃性、抗湿性
- Application: Over temperature protection of industrial power supply 应用：工业电源部分的超温保护

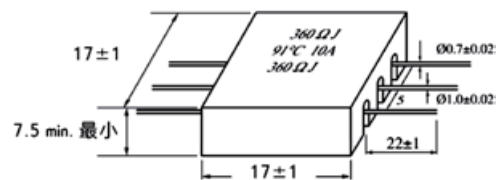

| Type 类型 | Fusing Temp. 熔断温度 | Rated current 额定电流 | Rated voltage 额定电压 |
|---------|-------------------|--------------------|--------------------|
| TFRC-2W | 91°C | 10A | 250V |

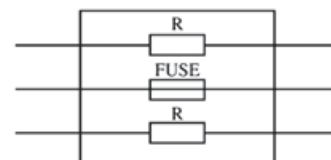

* detailed information please contact the factory 详细信息请联系工厂

Columnar Type Cement Fixed Resistors-QHO Type

圆柱状水泥电阻器 -QHO 型

- Circular ceramic 圓形瓷管外壳
- Excellent insulation and moisture resistance 优良的绝缘性和耐湿性
- Winding process, good resistance to load 绕线工艺, 良好的耐负荷能力
- Application: Power supply of frequency converter
应用: 变频器的电源



| Type 类型 | L±1 | L1±3 | ΦD±1 | d±0.05 |
|---------|-----|------|------|--------|
| QHO 4W | 43 | 30 | 8 | 0.75 |
| QHO 5W | 45 | 30 | 8 | 0.75 |
| QHO 7W | 50 | 30 | 9 | 0.75 |
| QHO 9W | 60 | 30 | 9 | 0.75 |
| QHO 11W | 65 | 30 | 9 | 0.75 |
| QHO 17W | 75 | 30 | 9 | 0.75 |

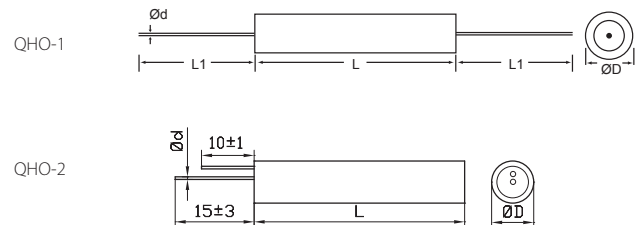

Multi-Lead Wire-wound Fixed Resistors - KNHW Type

多引线型绕线固定电阻器 - KNHW 型

- All materials are inorganic and non-flammable
所有的材料均为无机或非燃性的固体材料
- Super heat dissipation & High stability 散热性高, 稳定性好
- Special design of Multi-lead wire easy to assembled on PCB
特殊设计的多导线易于在PCB上安装
- Application: Charging or discharging resistance of electrical equipment such as elevator
应用: 电气设备如电梯的充电电阻或放电电阻



| Type 类型 | L±1 | A±1 | F±1 | P±1 | ΦD±1 | d±0.05 |
|---------|-----|-----|-----|-----|------|--------|
| KNHW10W | 45 | 10 | 15 | 12 | 11.5 | 1.0 |
| KNHW18W | 40 | 12 | 18 | 15 | 14.5 | 1.0 |
| KNHW25W | 50 | 12 | 18 | 15 | 14.5 | 1.0 |
| KNHW40W | 65 | 12 | 20 | 17 | 16.5 | 1.0 |

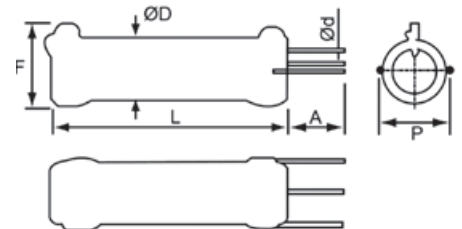

High Power Flat Wire-wound Fixed Resistors - KNHB Type

高功率扁平型绕线固定电阻器

- All materials are inorganic and non-flammable
所有的材料均为无机或非燃性的固体材料
- Can withstand High Voltage pulse in short-time 短时间可承受高电压脉冲
- Can use in single or in-piles 可单个或成堆使用
- Application: Charging or discharging resistance of electrical equipment such as elevator
应用: 电气设备如电梯的充电电阻或放电电阻



| Type 类型 | A±2 | B±1 | C±0.5 | D±1 | L±1 | N±2 |
|---------|-----|-----|-------|-----|-----|-----|
| KNHB21W | 32 | 19 | 12 | 14 | 68 | 51 |
| KNHB31W | 51 | 19 | 12 | 14 | 87 | 70 |
| KNHB53W | 90 | 19 | 12 | 14 | 126 | 109 |
| KNHB68W | 120 | 19 | 12 | 14 | 156 | 140 |
| KNHB91W | 153 | 19 | 12 | 14 | 189 | 173 |

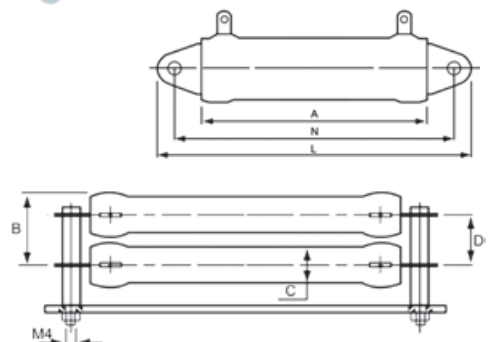

* detailed information please contact the factory 详细信息请联系工厂

High Power Wire-wound Flat Aluminum Shell Fixed Resistors - HPWR Type

高功率绕线扁平铝壳电阻器 - HPWR 型

- Anti-vibration, high stability 优异的抗震性和稳定性
- Easy to assembled on PCB 易于在PCB上安装
- Application: Power supply of frequency converter
应用: 变频器的电源



| Type 类型 | L±1 | L1±0.5 | L2 ⁺²⁰ / ₋₀ | W±0.5 | W1±0.2 | H±0.5 |
|----------|-----|--------|-----------------------------------|-------|--------|-------|
| HPWR 40W | 85 | 72 | 300 | 45 | 5.5 | 8.2 |

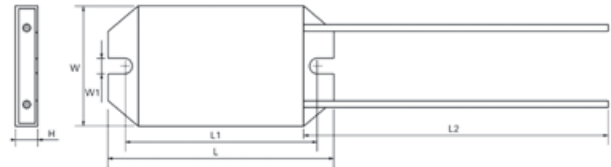

High Power Wire-wound Iron Shell Fixed Resistors - HPWR Type

高功率绕线铁壳固定电阻器 - HPWR 型

| Type 类型 | L±0.5 | L1±0.5 | W±0.5 | H±0.5 | L3±5 |
|----------|-------|--------|-------|-------|------|
| HPWR110W | 105 | 91.5 | 44.6 | 11.5 | 300 |
| HPWR120W | 195 | 184 | 40 | 14 | 250 |
| HPWR220W | 200 | 187 | 44.6 | 11.5 | 250 |

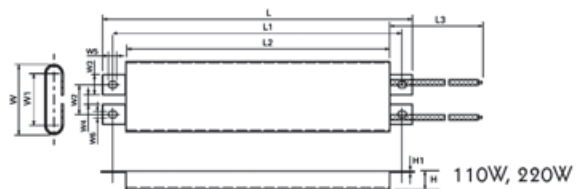
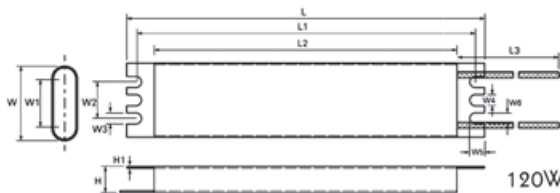

High Power Wire-wound Iron-Case Resistors - HAWF Type

高功率绕线型铁壳固定电阻器 - HAWF 型

- Anti-vibration, high stability 优异的抗震性和稳定性
- Excellent transient current impact capability, suitable for the start of the inverter under harsh conditions
优良的瞬间电流冲击能力, 适合变频器严苛条件下的启动
- Application: Frequency Conversion Equipment, such as Elevator, Freezer, Crane, Lift etc.
应用: 各类变频设备中, 如电梯, 冷柜, 起重机, 升降机等

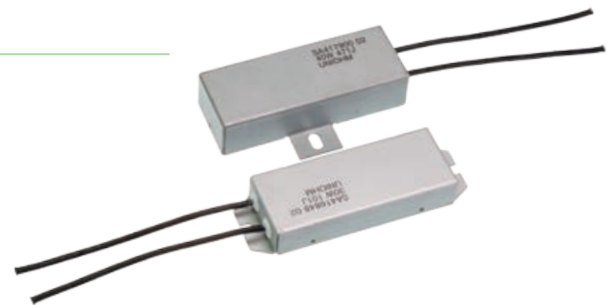

| Type 类型 | L±1 | W±1 | H±1 | L1±1 |
|---------|-----|-----|-----|------|
| HAWF30W | 97 | 32 | 15 | 90.5 |
| HAWF40W | 85 | 32 | 20 | 20 |

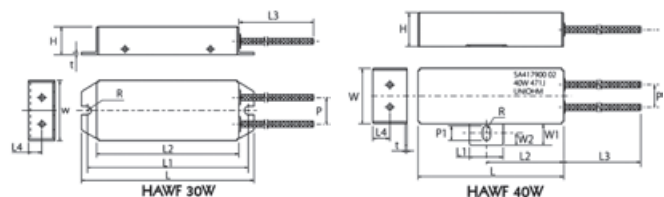

* detailed information please contact the factory 详细信息请联系工厂

High Power Wire-wound Aluminum Shell Resistance - HAWR Type

高功率绕线型铝壳电阻器 - HAWR 型

- Anti-vibration, high stability 优异的抗震性和稳定性
- Excellent transient current impact capability, suitable for the start of the inverter under harsh conditions
优良的瞬间电流冲击能力，适合变频器严苛条件下的启动
- Application: Frequency Conversion Equipment, such as Elevator, Freezer, Crane, Lift etc.
应用: 各类变频设备中, 如电梯, 冷柜, 起重机, 升降机等

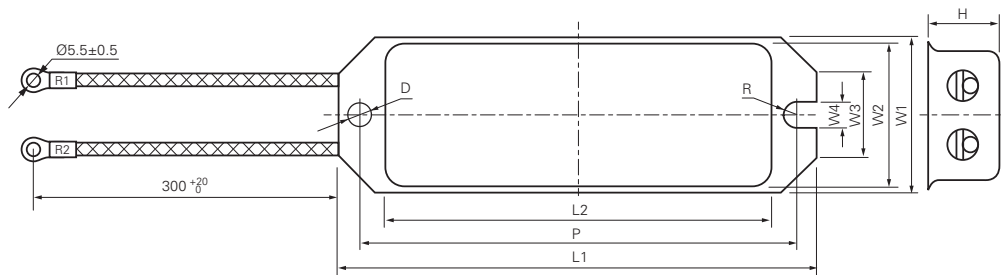

| Type 类型 | L1±1 | L2±2 | P±1 | W1±1 | W2±1 | W3±0.5 | W4±0.2 | D±0.2 | H±1 |
|----------|-------|-------|-------|------|------|--------|--------|-------|------|
| HAWR60W | 100 | 75.5 | 90 | 30 | 28 | 16.5 | 4.5 | 4.6 | 16.5 |
| HAWR80W | 130.5 | 104.5 | 117.5 | 43 | 38.5 | 22 | 6.0 | 6.0 | 21 |
| HAWR100W | 130 | 110 | 118 | 42 | 39 | 22.5 | 6.0 | 6.0 | 20 |

Type A Packing- 包装类型 A (mm)

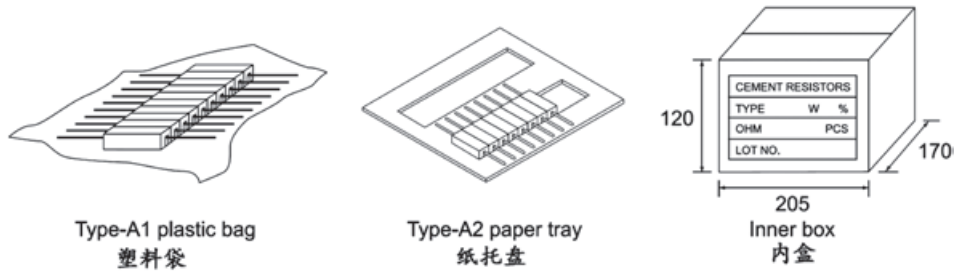

| Type 类型 | Qty/Plastic Bag(PCS) 每塑料袋数量 | Qty/Inner Box(PCS) 每内盒数量 | Qty/Carton (PCS) 每外箱数量 | Carton Size L×W×H(±5%) | Gross Wt.±2Kgs | Packing Type 包装类型 |
|----------------------|--------------------------------|-----------------------------|---------------------------|---------------------------|----------------|----------------------|
| PRW Series | | | | | | |
| PRW 1W | 10 | 500 | 3000 | 485×190×200 | 10.00 | Type A1 |
| PRW 2W | 10 | 400 | 2400 | 485×190×200 | 8.00 | Type A1 |
| PRW 3W | 10 | 500 | 3000 | 520×220×250 | 12.20 | Type A1 |
| PRW 5W | 10 | 400 | 2400 | 520×220×250 | 13.72 | Type A1 |
| PRW 7W | 10 | 300 | 1800 | 520×220×250 | 15.46 | Type A1 |
| PRW 10W | 10 | 250 | 1500 | 520×220×250 | 18.39 | Type A1 |
| PRW 15W | 10 | 70 | 420 | 510×200×250 | 8.20 | Type A1 |
| PRW 20W | 10 | 60 | 360 | 510×200×250 | 10.75 | Type A1 |
| PRW 25W | 10 | 60 | 360 | 510×200×250 | 11.22 | Type A1 |
| PRWA Series | | | | | | |
| PRWA 5W | 10 | 400 | 2400 | 520×220×250 | 15.00 | Type A1 |
| PRWA 7W | 10 | 240 | 1440 | 520×220×250 | 14.20 | Type A1 |
| PRWA 10W | 10 | 220 | 1320 | 520×220×250 | 16.30 | Type A1 |
| PRWC Series | | | | | | |
| PRWC 3W | 10 | 400 | 2400 | 485×190×200 | 7.30 | Type A1 |
| PRWC 5W | 10 | 400 | 2400 | 485×190×200 | 9.40 | Type A1 |
| PRWC 7W | 10 | 400 | 2400 | 520×220×250 | 14.00 | Type A1 |
| PRWC-1 Series | | | | | | |
| PRC1 4W | 50 | 500 | 3000 | 485×190×200 | 9.05 | Type A2 |
| PRC1 5W | 10 | 600 | 3600 | 485×190×200 | 13.45 | Type A1 |
| PRC1 6W | 40 | 400 | 2400 | 485×190×200 | 13.71 | Type A2 |
| PRT Series | | | | | | |
| PRT 10W | 10 | 200 | 1200 | 520×220×250 | 19.50 | Type A1 |
| PRT 15W | 5 | 150 | 900 | 520×220×250 | 22.00 | Type A1 |
| PRT 20W | 5 | 95 | 570 | 520×220×250 | 18.50 | Type A1 |
| PRT 30W | 5 | 45 | 270 | 520×220×250 | 21.40 | Type A1 |
| PRT 40W | 5 | 25 | 150 | 520×220×250 | 14.20 | Type A1 |

Note: The above is recommended packaging, the actual packing method is in accordance with the order.

注: 以上为推荐包装方式, 实际以工厂依订单情形的包装方式为准

Type A Packing 包装类型 A (mm)

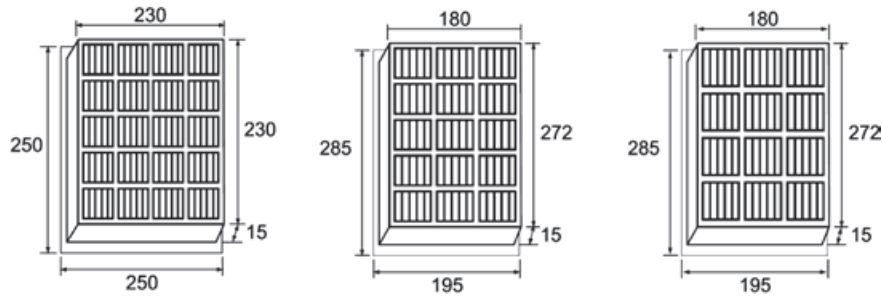

| Dimension of Plastic Case (mm) | | | |
|--------------------------------|-----|-----|-----|
| Type | A | B | C |
| Type - B1 | 260 | 105 | 260 |
| Type - B2 | 300 | 100 | 210 |
| Type - B3 | 300 | 100 | 210 |

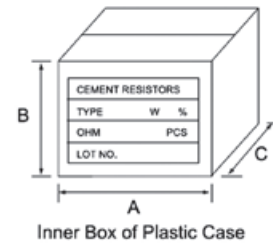

| Type 类型 | Qty/Plastic Bag(PCS) 每塑料袋数量 | Qty/Inner Box(PCS) 每内盒数量 | Qty/Carton (PCS) 每外箱数量 | Carton Size L×W×H(±5%) | Gross Wt.±2Kgs | Packing Type 包装类型 |
|-------------------------------|-----------------------------|--------------------------|------------------------|------------------------|----------------|-------------------|
| PRM/FTR Series | | | | | | |
| PRM2W | 10 (in Bag) | 700 | 4200 | 520×220×250 | 18.50 | Type A1 |
| PRM3W | 100 | 500 | 2000 | 535×270×220 | 14.20 | Type B1 |
| PRM5W | 100 | 500 | 2000 | 535×270×220 | 14.20 | Type B1 |
| PRM7W | 75 | 375 | 1500 | 435×305×215 | 17.42 | Type B2 |
| PRM 10W | 60 | 300 | 1200 | 435×305×215 | 18.12 | Type B3 |
| PFA 10W | 10 (in Bag) | 150 | 900 | 520×220×250 | 14.74 | Type A1 |
| PRMA Series | | | | | | |
| PRMA 5W | 100 | 500 | 2000 | 535×270×220 | 14.00 | Type B1 |
| PRMA 10W | 10 (in Bag) | 150 | 900 | 485×190×200 | 14.50 | Type A1 |
| PFAS & PFAT Series | | | | | | |
| PFAS 2W | 20 (in Bag) | 600 | 3600 | 485×190×200 | 7.10 | Type A1 |
| PFAS 5W | 20 (in Bag) | 500 | 3000 | 485×190×200 | 9.72 | Type A1 |
| PFAS 7W | 160 | 900 | 3600 | 435×305×215 | 16.20 | Type B1 |
| PFAS 10W | 10 (in Bag) | 500 | 3000 | 520×220×250 | 22.40 | Type A1 |
| PFAT 5W | 10 (in Bag) | 300 | 1800 | 485×190×200 | 13.20 | Type A1 |
| PFAT 7W | 10 (in Bag) | 250 | 1500 | 485×190×200 | 11.50 | Type A1 |

Note: The above is recommended packaging, the actual packing method is in accordance with the order.
注: 以上为推荐包装方式, 实际以工厂依订单情形的包装方式为准

Type B Packing-Plastic Case 包装类型 B - 塑料盒 (mm)

| Type 类型 | Qty/Plastic Bag(PCS) 每塑料袋数量 | Qty/Inner Box(PCS) 每内盒数量 | Qty/Carton (PCS) 每外箱数量 | Carton Size L×W×H(±5%) | Gross Wt.±2Kgs | Packing Type 包装类型 |
|-------------------------------|-----------------------------------|-----------------------------|---------------------------|---------------------------|----------------|----------------------|
| PRM/FTR Series | | | | | | |
| PRM2W / PF2 | 10(in Bag) | 700 | 4200 | 520×220×250 | 18.50 | Type A1 |
| PRM3W / PF3 | 100 | 500 | 2000 | 535×270×220 | 14.20 | Type B1 |
| PRM5W / PF5 | 100 | 500 | 2000 | 535×270×220 | 14.20 | Type B1 |
| PRM7W / PF7 | 75 | 375 | 1500 | 435×305×215 | 17.42 | Type B2 |
| PRM 10W | 60 | 300 | 1200 | 435×305×215 | 18.12 | Type B3 |
| PFA 10W | 10(in Bag) | 150 | 900 | 520×220×250 | 14.74 | Type A1 |
| PRMA Series | | | | | | |
| PRMA 5W | 100 | 500 | 2000 | 535×270×220 | 14.00 | Type B1 |
| PRMA 10W | 10(in Bag) | 150 | 900 | 485×190×200 | 14.50 | Type A1 |
| PFAS & PFAT Series | | | | | | |
| PFAS 2W | 20(in Bag) | 600 | 3600 | 485×190×200 | 7.10 | Type A1 |
| PFAS 5W | 20(in Bag) | 500 | 3000 | 485×190×200 | 9.72 | Type A1 |
| PFAS 7W | 160 | 900 | 3600 | 435×305×215 | 16.20 | Type B1 |
| PFAS 10W | 10(in Bag) | 500 | 3000 | 520×220×250 | 22.40 | Type A1 |
| PFAT 5W | 10(in Bag) | 300 | 1800 | 485×190×200 | 13.20 | Type A1 |
| PFAT 7W | 10(in Bag) | 250 | 1500 | 485×190×200 | 11.50 | Type A1 |
| PRU Series | | | | | | |
| PRU 10W | 100 | 100 | 1000 | 560×305×310 | 12.50 | Type D |
| PRU 15W | 80 | 80 | 800 | 560×305×310 | 17.33 | Type D |
| PRU 20W | 60 | 60 | 600 | 560×305×310 | 17.85 | Type D |
| PRU 30W | 20 | 40 | 160 | 435×305×215 | 16.37 | Type D |
| PRU 40W | 20 | 20 | 160 | 435×305×215 | 16.37 | Type D |

Note: The above is recommended packaging, the actual packing method is in accordance with the order.

注: 以上为推荐包装方式, 实际以工厂依订单情形的包装方式为准

| 测试项目 | 引用标准 | 测试方法 |
|---|---|---|
| Temperature coefficient 温度系数 | GB-T 5729 4.8 JIS-C-5201 4.13 IEC 60115-1 4.8 | Natural resistance change per temperature degree centigrade 实际阻值随温度变化的变化率: $\frac{R_2 - R_1}{R_1(t_2 - t_1)} \times 10^6 \text{ (PPM / } ^\circ\text{C)}$ R ₁ : Resistance value at room temperature 室温下的阻值 (t ₁); R ₂ : Resistance value at room temperature +100°C 室温加上 100°C 的阻值 (t ₂). Test pattern: Room temperature (t ₁), Room temperature +100°C (t ₂) 测试结构: 室温 (t ₁), 室温 +100°C (t ₂) |
| Short-time overload 短时间过负荷 | GB-T 5729 4.13 JIS-C-5201 4.13 IEC 60115-1 4.13 | Permanent resistance change after the application of a potential of 2.5 times RCWV or Max.Overload Votage whichever less for 5 seconds. 加 2.5 倍额定工作电压或最大过负荷电压 (取其低者), 持续 5 秒钟, 测阻值变化。 |
| Insulation resistance 绝缘阻值 | GB-T 5729 4.6 JIS-C-5201 4.6 IEC 60115-1 4.6 | 1. Chip Resistor: the measuring voltage shall be, measured with a direct voltage of (100±15)V or a voltage equal to the dielectric withstanding voltage, and apply for 1 min. 2. TH Resistor: the measuring voltage shall be equal to the dielectric withstanding voltage for resistor with an isolation voltage < 500V or (500±50)V DC, for resistors with an isolation voltage≥500V. 1. 贴片电阻: 绝缘耐压 < 100V, 测试电压取绝缘耐压的电压; 绝缘耐压 ≥100V, 测试电压为 100±15VDC, 1 分钟后量测阻值。 2. 插件电阻: 绝缘耐压 < 500V, 测试电压取绝缘耐压的电压; 绝缘耐压 ≥500V. 测试电压为 500±50VDC, 1 分钟后量测阻值。 |
| Dielectric Withstanding Voltage 绝缘耐压 | GB-T 5729 4.7 JIS-C-5201 4.7 IEC 60115-1 4.7 | Resistor shall be clamped in the trough of 90° metallic -block and shall be tested at AC potential respectively specified in the given list of each product type for 60-70 seconds.For Cement Fixed Resistors,the testing voltage is 1000V. 电阻固定在 90° 的 V 型槽中, 根据不同产品规定交流电压, 持续 60~70 秒, 水泥型电阻电压设定为 1000V。 |
| Pulse overload 脉冲过负荷 | GB-T 5729 4.28 JIS-C-5201 4.28 IEC 60115-1 4.28 | Rsistance change after 10000 cycles(1 second"ON",25 seconds"OFF") at 4 times of RCWV or Max.Overload whichever less. 10000 次循环后变化 (1 秒 "通", 25 秒断)4 倍工作电压或最大工作电压 (取其最低者)。 |
| Terminal strength 端子强度 | GB-T 5729 4.16 JIS-C-5201 4.16 IEC 60115-1 4.16 | Direct Load:Resistance at a 2.5kg direct load for 10 seconds in the direction of the longitudinal axis of the terminal leads. Twist Test:Terminal leads shall be bent through 90° at a point of about 6mm from the body of the resistor and shall be rotated through 360° about the original axis of the bent terminal in alternating direction for a total of 3 rotations. 直接负荷: 在电阻引线方向直接加 2.5 公斤力 10 秒。扭曲测试: 两端导线折弯 90 度在熔点 6mm 处交替旋转 360 度 3 次。 |
| Terminal strength 端子强度 | GB-T 5729 4.16 JIS-C-5201 4.16 IEC 60115-1 4.16 | (Applicable for Resister Network 适用网络电阻) Tensile: 1KG,30 seconds /Bending:500g,2 times 张力: 1KG, 30 秒 / 弯曲: 500g, 2 次。 |
| Terminal bending 端子弯曲 | GB-T 5729 4.33 JIS-C-5201 4.33 IEC 60115-1 4.33 | (Applicable for CHIP Resistors 适用晶片电阻) Twist of Test Board:Y/X=3/90mm 60 seconds. 测试板弯曲: Y/X=3/90mm 60 秒。 |
| Soldering heat 耐焊接热 | GB-T 5729 4.18 JIS-C-5201 4.18 IEC 60115-1 4.18 | (Applicable for CHIP Resistors 适用晶片电阻) Dip the resistor into a temperature of 260±5°C and hold it for a 10±1 seconds. |
| Soldering heat 耐焊接热 | GB-T 5729 4.18 JIS-C-5201 4.18 IEC 60115-1 4.18 | (Applicable forTH Resistors 适用插件电阻) Permanent resister change when leads immersed to a point 2.0~2.5mm from the body in 260±5°C solder 10±1 seconds . 锡炉温度 260±5°C, 浸入深度: 离本体导线根部约 2.0~2.5mm, 处浸入时间 10±1 秒。 |
| Solderability 可焊性 | GB-T 5729 4.17 JIS-C-5201 4.17 IEC 60115-1 4.17 | The area covered with a new,smooth, clean, shiny and continuous surface free from concentrated pinholes. Temperature of solder: 245±3°C; Dwell time in solder: 2~3 seconds. 表面光滑、清洁、均匀、有光泽, 锡炉温度: 245±3°C; 浸入时间: 2~3 秒。 |
| Resistance to solvent 耐溶剂 | GB-T 5729 4.29 JIS-C-5201 4.29 IEC 60115-1 4.29 | Specimens shall be immersed in a bath of alcohol completely for a 3 minutes using ultrasonic test equipment. 电阻浸入异丙醇超声波清洗 3 分钟。 |
| Thermal shock 热冲击 | GB-T 5729 4.21 JIS-C-5201 4.21 IEC 60115-1 4.21 | (Applicable for Resistor Network 适用于网络电阻) Load V,Room temperature,30 minutes.Unload, -55°C, 15minutes. Over 2 hours in room temperature before measuring. 加电压: 室温 30 分钟. 不加电压: -55°C, 15 分钟. 室温下过 2 小时测量变化率。 |
| Temperature cycling 温度循环 | GB-T 5729 4.19 JIS-C-5201 4.19 IEC 60115-1 4.19 | Resistance change after continuous 5 cycles for duty cycle specified below Step 1: 30 minutes at -55±3°C Step 2: 10~15 minutes at Room temperature Step 3: 30 minutes at 155±2°C Step 4: 10~15 minutes at Room temperature 连续 5 次温度循环 (如下所示) 步骤: 步骤 1: 温度: -55±3°C 时间: 30 分钟 步骤 2: 温度: 室温 时间: 10~15 分钟 步骤 3: 温度: 155±2°C 时间: 30 分钟 步骤 4: 温度: 室温 时间: 10~15 分钟 |
| Humidity(Steady State) 恒定湿热 | GB-T 5729 4.24 JIS-C-5201 4.24 IEC 60115-1 4.24 | Temporary resistance change after 240 hours exposure in a humidity test chamber controlled at 40±2°C and 90~95% RH. 在 40±2°C 和 90~95% RH 相对湿度条件下, 存放 240 小时后阻值变化率。 |
| Load life in humidity 湿度寿命 | JIS-C-5202 7.9 | Resistance change after 1000 hours (1.5hours"ON", 0.5hours"OFF") at RCWV or Max.Working Voltage whichever less in a humidity test chamber controlled at 40±2°C and 90~95% RH. 持续时间: 1000 小时 (1.5 小时 "通", 0.5 小时 "断"); 试验温度: 40±2°C; 相对湿度: 90~95% RH; 试验电压: 额定工作电压或最大工作电压 (取其低者)。 |
| Load life 负载寿命 | GB-T 5729 4.25.1 JIS-C-5201 4.25.1 IEC 60115-1 4.25.1 | Permanent Resistance change after 1000 hours operating at RCWV or Max.Working Voltage whichever less with duty cycle of 1.5 hours "ON", 0.5 hour "OFF" at 70±2°C ambient. 持续时间: 1000 小时 (1.5 小时 "通", 0.5 小时 "断"); 试验温度: 70±2°C; 试验电压: 额定工作电压或最大工作电压 (取其低者)。 |
| Accidental overload 意外过载 | GB-T 5729 4.26 JIS-C-5201 4.26 IEC 60115-1 4.26 | Resistors shall resist flaming or arcing when overload up to 5,10,16,25,40,63,100 times power or 4times Max.Working Voltage , whichever less. 施加 5,10,16,25,40,63 和 100 倍额定功耗的过负荷, 但所加的电压不超过 4 倍的最大工作电压, 测试其阻燃性。 |

** RCWV = Rated Continuous Working Voltage = $\frac{\text{Rated Power} \times \text{Resistance Value}}{\sqrt{\text{额定功率} \times \text{阻值}}}$ the calculated value or the Max. Working Voltage whichever less. 计算值或该产品最大工作电压取其低者

The below chart shows the nominal resistance value for each series. The values in the chart have been in this order using the approximate values that are based on the common ratios given in the following table:

下表列出每种系列的标准阻值，表中的阻值是按照通用倍率得出的接近阻值。

| Series 系列 | Common Ratio 通用倍率 | Remarks 备注 |
|-----------|------------------------|---|
| E-6 | $\sqrt[6]{10}$ (1.46) | Rounded off to a 2-digit figure (2 位有效数字) |
| E-12 | $\sqrt[12]{10}$ (1.21) | Rounded off to a 2-digit figure (2 位有效数字) |
| E-24 | $\sqrt[24]{10}$ (1.10) | Rounded off to a 2-digit figure (2 位有效数字) |
| E-96 | $\sqrt[96]{10}$ (1.02) | Rounded off to a 3-digit figure (3 位有效数字) |

| E-6 | E-12 | E-24 | E-96 | E-6 | E-12 | E-24 | E-96 | E-6 | E-12 | E-24 | E-96 | | | | | | | | | | | | | | |
|------|------|------|------|-----|------|------|------|-----|------|------|------|------|-----|-----|-----|------|------|-----|-----|------|------|-----|-----|-----|------|
| 1.0 | 1.0 | 1.0 | 1.00 | 2.2 | 2.2 | 2.2 | 2.15 | 4.7 | 4.7 | 4.7 | 4.64 | | | | | | | | | | | | | | |
| | | | 1.02 | | | | 2.21 | | | | 4.75 | | | | | | | | | | | | | | |
| | | | 1.05 | | | | 2.26 | | | | 4.87 | | | | | | | | | | | | | | |
| | | | 1.07 | | | | 2.32 | | | | 4.99 | | | | | | | | | | | | | | |
| | 1.1 | 1.1 | 1.1 | | | 1.10 | 2.7 | | | 2.7 | 2.7 | 2.37 | 5.6 | 5.6 | 5.6 | 5.11 | | | | | | | | | |
| | | | | | | 1.13 | | | | | | 2.43 | | | | 5.23 | | | | | | | | | |
| | | | | | | 1.15 | | | | | | 2.49 | | | | 5.36 | | | | | | | | | |
| | | | | | | 1.18 | | | | | | 2.55 | | | | 5.49 | | | | | | | | | |
| | | | | | | 1.2 | | | | | | 1.2 | | | | 1.2 | 1.21 | 3.0 | 3.0 | 3.0 | 2.61 | 6.2 | 6.2 | 6.2 | 5.62 |
| | | | | | | | | | | | | | | | | | 1.24 | | | | 2.67 | | | | 5.76 |
| | | | | | | | | | | | | | | | | | 1.27 | | | | 2.74 | | | | 5.90 |
| | | | | | | | | | | | | | | | | | 1.30 | | | | 2.80 | | | | 6.04 |
| 1.3 | 1.3 | 1.3 | 1.33 | 3.3 | 3.3 | 3.3 | 2.87 | 7.5 | 7.5 | 7.5 | 6.19 | | | | | | | | | | | | | | |
| | | | 1.37 | | | | 2.94 | | | | 6.34 | | | | | | | | | | | | | | |
| | | | 1.40 | | | | 3.01 | | | | 6.49 | | | | | | | | | | | | | | |
| | | | 1.43 | | | | 3.09 | | | | 6.65 | | | | | | | | | | | | | | |
| | | | 1.5 | | | | 1.5 | | | | 1.5 | 1.47 | 3.6 | 3.6 | 3.6 | 3.16 | 8.2 | 8.2 | 8.2 | 6.81 | | | | | |
| | | | | | | | | | | | | 1.50 | | | | 3.24 | | | | 6.98 | | | | | |
| 1.54 | 3.32 | 7.15 | | | | | | | | | | | | | | | | | | | | | | | |
| 1.58 | 3.40 | 7.32 | | | | | | | | | | | | | | | | | | | | | | | |
| 1.6 | 1.6 | 1.6 | 1.62 | 3.9 | 3.9 | 3.9 | 3.48 | 9.1 | 9.1 | 9.1 | 7.50 | | | | | | | | | | | | | | |
| | | | 1.65 | | | | 3.57 | | | | 7.68 | | | | | | | | | | | | | | |
| | | | 1.69 | | | | 3.65 | | | | 7.87 | | | | | | | | | | | | | | |
| | | | 1.74 | | | | 3.74 | | | | 8.06 | | | | | | | | | | | | | | |
| | | | 1.8 | | | | 1.8 | | | | 1.8 | 1.78 | 4.3 | 4.3 | 4.3 | 3.83 | 9.1 | 9.1 | 9.1 | 8.25 | | | | | |
| | | | | | | | | | | | | 1.82 | | | | 3.92 | | | | 8.45 | | | | | |
| 1.87 | 4.02 | 8.66 | | | | | | | | | | | | | | | | | | | | | | | |
| 1.91 | 4.12 | 8.87 | | | | | | | | | | | | | | | | | | | | | | | |
| 2.0 | 2.0 | 2.0 | 1.96 | 4.3 | 4.3 | 4.3 | 4.22 | 9.1 | 9.1 | 9.1 | 9.09 | | | | | | | | | | | | | | |
| | | | 2.00 | | | | 4.32 | | | | 9.31 | | | | | | | | | | | | | | |
| | | | 2.05 | | | | 4.42 | | | | 9.53 | | | | | | | | | | | | | | |
| | | | 2.10 | | | | 4.53 | | | | 9.76 | | | | | | | | | | | | | | |

E-24 series standard resistance value & the codes to be used in the part No. system 5% & 10% tolerance (4 digits, start with "0"):

E-24 系列标准阻值和料号系统使用代码 (4 位, 以 0 为首位, 5%、10% 公差):

| Value 阻值 | Code 代码 | Value 阻值 | Code 代码 | Value 阻值 | Code 代码 | Value 阻值 | Code 代码 | Value 阻值 | Code 代码 | Value 阻值 | Code 代码 | Value 阻值 | Code 代码 |
|----------|---------|----------|---------|----------|---------|----------|---------|----------|---------|----------|---------|----------|---------|
| 1.0Ω | 010J | 10Ω | 0100 | 100Ω | 0101 | 1.0KΩ | 0102 | 10KΩ | 0103 | 100KΩ | 0104 | 1.0MΩ | 0105 |
| 1.1Ω | 011J | 11Ω | 0110 | 110Ω | 0111 | 1.1KΩ | 0112 | 11KΩ | 0113 | 110KΩ | 0114 | 1.1MΩ | 0115 |
| 1.2Ω | 012J | 12Ω | 0120 | 120Ω | 0121 | 1.2KΩ | 0122 | 12KΩ | 0123 | 120KΩ | 0124 | 1.2MΩ | 0125 |
| 1.3Ω | 013J | 13Ω | 0130 | 130Ω | 0131 | 1.3KΩ | 0132 | 13KΩ | 0133 | 130KΩ | 0134 | 1.3MΩ | 0135 |
| 1.5Ω | 015J | 15Ω | 0150 | 150Ω | 0151 | 1.5KΩ | 0152 | 15KΩ | 0153 | 150KΩ | 0154 | 1.5MΩ | 0155 |
| 1.6Ω | 016J | 16Ω | 0160 | 160Ω | 0161 | 1.6KΩ | 0162 | 16KΩ | 0163 | 160KΩ | 0164 | 1.6MΩ | 0165 |
| 1.8Ω | 018J | 18Ω | 0180 | 180Ω | 0181 | 1.8KΩ | 0182 | 18KΩ | 0183 | 180KΩ | 0184 | 1.8MΩ | 0185 |
| 2.0Ω | 020J | 20Ω | 0200 | 200Ω | 0201 | 2.0KΩ | 0202 | 20KΩ | 0203 | 200KΩ | 0204 | 2.0MΩ | 0205 |
| 2.2Ω | 022J | 22Ω | 0220 | 220Ω | 0221 | 2.2KΩ | 0222 | 22KΩ | 0223 | 220KΩ | 0224 | 2.2MΩ | 0225 |
| 2.4Ω | 024J | 24Ω | 0240 | 240Ω | 0241 | 2.4KΩ | 0242 | 24KΩ | 0243 | 240KΩ | 0244 | 2.4MΩ | 0245 |
| 2.7Ω | 027J | 27Ω | 0270 | 270Ω | 0271 | 2.7KΩ | 0272 | 27KΩ | 0273 | 270KΩ | 0274 | 2.7MΩ | 0275 |
| 3.0Ω | 030J | 30Ω | 0300 | 300Ω | 0301 | 3.0KΩ | 0302 | 30KΩ | 0303 | 300KΩ | 0304 | 3.0MΩ | 0305 |
| 3.3Ω | 033J | 33Ω | 0330 | 330Ω | 0331 | 3.3KΩ | 0332 | 33KΩ | 0333 | 330KΩ | 0334 | 3.3MΩ | 0335 |
| 3.6Ω | 036J | 36Ω | 0360 | 360Ω | 0361 | 3.6KΩ | 0362 | 36KΩ | 0363 | 360KΩ | 0364 | 3.6MΩ | 0365 |
| 3.9Ω | 039J | 39Ω | 0390 | 390Ω | 0391 | 3.9KΩ | 0392 | 39KΩ | 0393 | 390KΩ | 0394 | 3.9MΩ | 0395 |
| 4.3Ω | 043J | 43Ω | 0430 | 430Ω | 0431 | 4.3KΩ | 0432 | 43KΩ | 0433 | 430KΩ | 0434 | 4.3MΩ | 0435 |
| 4.7Ω | 047J | 47Ω | 0470 | 470Ω | 0471 | 4.7KΩ | 0472 | 47KΩ | 0473 | 470KΩ | 0474 | 4.7MΩ | 0475 |
| 5.1Ω | 051J | 51Ω | 0510 | 510Ω | 0511 | 5.1KΩ | 0512 | 51KΩ | 0513 | 510KΩ | 0514 | 5.1MΩ | 0515 |
| 5.6Ω | 056J | 56Ω | 0560 | 560Ω | 0561 | 5.6KΩ | 0562 | 56KΩ | 0563 | 560KΩ | 0564 | 5.6MΩ | 0565 |
| 6.2Ω | 062J | 62Ω | 0620 | 620Ω | 0621 | 6.2KΩ | 0622 | 62KΩ | 0623 | 620KΩ | 0624 | 6.2MΩ | 0625 |
| 6.8Ω | 068J | 68Ω | 0680 | 680Ω | 0681 | 6.8KΩ | 0682 | 68KΩ | 0683 | 680KΩ | 0684 | 6.8MΩ | 0685 |
| 7.5Ω | 075J | 75Ω | 0750 | 750Ω | 0751 | 7.5KΩ | 0752 | 75KΩ | 0753 | 750KΩ | 0754 | 7.5MΩ | 0755 |
| 8.2Ω | 082J | 82Ω | 0820 | 820Ω | 0821 | 8.2KΩ | 0822 | 82KΩ | 0823 | 820KΩ | 0824 | 8.2MΩ | 0825 |
| 9.1Ω | 091J | 91Ω | 0910 | 910Ω | 0911 | 9.1KΩ | 0912 | 91KΩ | 0913 | 910KΩ | 0914 | 9.1MΩ | 0915 |
| | | | | | | | | | | | | 10MΩ | 0106 |

E-96 series standard resistance value & the codes to be used in the part No. system not over 2% tolerance (4 digits):

E-96 系列标准阻值和料号系统使用代码 (4 位, 0.1%、0.25%、0.5%、1%、2% 公差):

| Value 阻值 | Code 代码 | Value 阻值 | Code 代码 | Value 阻值 | Code 代码 | Value 阻值 | Code 代码 | Value 阻值 | Code 代码 | Value 阻值 | Code 代码 | Value 阻值 | Code 代码 | Value 阻值 | Code 代码 |
|----------|---------|----------|---------|----------|---------|----------|---------|----------|---------|----------|---------|----------|---------|----------|---------|
| 10.0Ω | 100J | 17.8Ω | 178J | 31.6Ω | 316J | 56.2Ω | 562J | 100Ω | 1000 | 178Ω | 1780 | 316Ω | 3160 | 562Ω | 5620 |
| 10.2Ω | 102J | 18.2Ω | 182J | 32.4Ω | 324J | 57.6Ω | 576J | 102Ω | 1020 | 182Ω | 1820 | 324Ω | 3240 | 576Ω | 5760 |
| 10.5Ω | 105J | 18.7Ω | 187J | 33.2Ω | 332J | 59.0Ω | 590J | 105Ω | 1050 | 187Ω | 1870 | 332Ω | 3320 | 590Ω | 5900 |
| 10.7Ω | 107J | 19.1Ω | 191J | 34.0Ω | 340J | 60.4Ω | 604J | 107Ω | 1070 | 191Ω | 1910 | 340Ω | 3400 | 604Ω | 6040 |
| 11.0Ω | 110J | 19.6Ω | 196J | 34.8Ω | 348J | 61.9Ω | 619J | 110Ω | 1100 | 196Ω | 1960 | 348Ω | 3480 | 619Ω | 6190 |
| 11.3Ω | 113J | 20.0Ω | 200J | 35.7Ω | 357J | 63.4Ω | 634J | 113Ω | 1130 | 200Ω | 2000 | 357Ω | 3570 | 634Ω | 6340 |
| 11.5Ω | 115J | 20.5Ω | 205J | 36.5Ω | 365J | 64.9Ω | 649J | 115Ω | 1150 | 205Ω | 2050 | 365Ω | 3650 | 649Ω | 6490 |
| 11.8Ω | 118J | 21.0Ω | 210J | 37.4Ω | 374J | 66.5Ω | 665J | 118Ω | 1180 | 210Ω | 2100 | 374Ω | 3740 | 665Ω | 6650 |
| 12.1Ω | 121J | 21.5Ω | 215J | 38.3Ω | 383J | 68.1Ω | 681J | 121Ω | 1210 | 215Ω | 2150 | 383Ω | 3830 | 681Ω | 6810 |
| 12.4Ω | 124J | 22.1Ω | 221J | 39.2Ω | 392J | 69.8Ω | 698J | 124Ω | 1240 | 221Ω | 2210 | 392Ω | 3920 | 698Ω | 6980 |
| 12.7Ω | 127J | 22.6Ω | 226J | 40.2Ω | 402J | 71.5Ω | 715J | 127Ω | 1270 | 226Ω | 2260 | 402Ω | 4020 | 715Ω | 7150 |
| 13.0Ω | 130J | 23.2Ω | 232J | 41.2Ω | 412J | 73.2Ω | 732J | 130Ω | 1300 | 232Ω | 2320 | 412Ω | 4120 | 732Ω | 7320 |
| 13.3Ω | 133J | 23.7Ω | 237J | 42.2Ω | 422J | 75.0Ω | 750J | 133Ω | 1330 | 237Ω | 2370 | 422Ω | 4220 | 750Ω | 7500 |
| 13.7Ω | 137J | 24.3Ω | 243J | 43.2Ω | 432J | 76.8Ω | 768J | 137Ω | 1370 | 243Ω | 2430 | 432Ω | 4320 | 768Ω | 7680 |
| 14.0Ω | 140J | 24.9Ω | 249J | 44.2Ω | 442J | 78.7Ω | 787J | 140Ω | 1400 | 249Ω | 2490 | 442Ω | 4420 | 787Ω | 7870 |
| 14.3Ω | 143J | 25.5Ω | 255J | 45.3Ω | 453J | 80.6Ω | 806J | 143Ω | 1430 | 255Ω | 2550 | 453Ω | 4530 | 806Ω | 8060 |
| 14.7Ω | 147J | 26.1Ω | 261J | 46.4Ω | 464J | 82.5Ω | 825J | 147Ω | 1470 | 261Ω | 2610 | 464Ω | 4640 | 825Ω | 8250 |
| 15.0Ω | 150J | 26.7Ω | 267J | 47.5Ω | 475J | 84.5Ω | 845J | 150Ω | 1500 | 267Ω | 2670 | 475Ω | 4750 | 845Ω | 8450 |
| 15.4Ω | 154J | 27.4Ω | 274J | 48.7Ω | 487J | 86.6Ω | 866J | 154Ω | 1540 | 274Ω | 2740 | 487Ω | 4870 | 866Ω | 8660 |
| 15.8Ω | 158J | 28.0Ω | 280J | 49.9Ω | 499J | 88.7Ω | 887J | 158Ω | 1580 | 280Ω | 2800 | 499Ω | 4990 | 887Ω | 8870 |
| 16.2Ω | 162J | 28.7Ω | 287J | 51.1Ω | 511J | 90.9Ω | 909J | 162Ω | 1620 | 287Ω | 2870 | 511Ω | 5110 | 909Ω | 9090 |
| 16.5Ω | 165J | 29.4Ω | 294J | 52.3Ω | 523J | 93.1Ω | 931J | 165Ω | 1650 | 294Ω | 2940 | 523Ω | 5230 | 931Ω | 9310 |
| 16.9Ω | 169J | 30.1Ω | 301J | 53.6Ω | 536J | 95.3Ω | 953J | 169Ω | 1690 | 301Ω | 3010 | 536Ω | 5360 | 953Ω | 9530 |
| 17.4Ω | 174J | 30.9Ω | 309J | 54.9Ω | 549J | 97.6Ω | 976J | 174Ω | 1740 | 309Ω | 3090 | 549Ω | 5490 | 976Ω | 9760 |

| Value 阻值 | Code 代码 | Value 阻值 | Code 代码 | Value 阻值 | Code 代码 | Value 阻值 | Code 代码 | Value 阻值 | Code 代码 | Value 阻值 | Code 代码 | Value 阻值 | Code 代码 | Value 阻值 | Code 代码 |
|----------|---------|----------|---------|----------|---------|----------|---------|----------|---------|----------|---------|----------|---------|----------|---------|
| 1.00K | 1001 | 2.37K | 2371 | 5.62K | 5621 | 13.3K | 1332 | 31.6K | 3162 | 75.0K | 7502 | 178K | 1783 | 422K | 4223 |
| 1.02K | 1021 | 2.43K | 2431 | 5.76K | 5761 | 13.7K | 1372 | 32.4K | 3242 | 76.8K | 7682 | 182K | 1823 | 432K | 4323 |
| 1.05K | 1051 | 2.49K | 2491 | 5.90K | 5901 | 14.0K | 1402 | 33.2K | 3322 | 78.7K | 7872 | 187K | 1873 | 442K | 4423 |
| 1.07K | 1071 | 2.55K | 2551 | 6.04K | 6041 | 14.3K | 1432 | 34.0K | 3402 | 80.6K | 8062 | 191K | 1913 | 453K | 4533 |
| 1.10K | 1101 | 2.61K | 2611 | 6.19K | 6191 | 14.7K | 1472 | 34.8K | 3482 | 82.5K | 8252 | 196K | 1963 | 464K | 4643 |
| 1.13K | 1131 | 2.67K | 2671 | 6.34K | 6341 | 15.0K | 1502 | 35.7K | 3572 | 84.5K | 8452 | 200K | 2003 | 475K | 4753 |
| 1.15K | 1151 | 2.74K | 2741 | 6.49K | 6491 | 15.4K | 1542 | 36.5K | 3652 | 86.6K | 8662 | 205K | 2053 | 487K | 4873 |
| 1.18K | 1181 | 2.80K | 2801 | 6.65K | 6651 | 15.8K | 1582 | 37.4K | 3742 | 88.7K | 8872 | 210K | 2103 | 499K | 4993 |
| 1.21K | 1211 | 2.87K | 2871 | 6.81K | 6811 | 16.2K | 1622 | 38.3K | 3832 | 90.9K | 9092 | 215K | 2153 | 511K | 5113 |
| 1.24K | 1241 | 2.94K | 2941 | 6.98K | 6981 | 16.5K | 1652 | 39.2K | 3922 | 93.1K | 9312 | 221K | 2213 | 523K | 5233 |
| 1.27K | 1271 | 3.01K | 3011 | 7.15K | 7151 | 16.9K | 1692 | 40.2K | 4022 | 95.3K | 9532 | 226K | 2263 | 536K | 5363 |
| 1.30K | 1301 | 3.09K | 3091 | 7.32K | 7321 | 17.4K | 1742 | 41.2K | 4122 | 97.6K | 9762 | 232K | 2323 | 549K | 5493 |
| 1.33K | 1331 | 3.16K | 3161 | 7.50K | 7501 | 17.8K | 1782 | 42.2K | 4222 | 100K | 1003 | 237K | 2373 | 562K | 5623 |
| 1.37K | 1371 | 3.24K | 3241 | 7.68K | 7681 | 18.2K | 1822 | 43.2K | 4322 | 102K | 1023 | 243K | 2433 | 576K | 5763 |
| 1.40K | 1401 | 3.32K | 3321 | 7.87K | 7871 | 18.7K | 1872 | 44.2K | 4422 | 105K | 1053 | 249K | 2493 | 590K | 5903 |
| 1.43K | 1431 | 3.40K | 3401 | 8.06K | 8061 | 19.1K | 1912 | 45.3K | 4532 | 107K | 1073 | 255K | 2553 | 604K | 6043 |
| 1.47K | 1471 | 3.48K | 3481 | 8.25K | 8251 | 19.6K | 1962 | 46.4K | 4642 | 110K | 1103 | 261K | 2613 | 619K | 6193 |
| 1.50K | 1501 | 3.57K | 3571 | 8.45K | 8451 | 20.0K | 2002 | 47.5K | 4752 | 113K | 1133 | 267K | 2673 | 634K | 6343 |
| 1.54K | 1541 | 3.65K | 3651 | 8.66K | 8661 | 20.5K | 2052 | 48.7K | 4872 | 115K | 1153 | 274K | 2743 | 649K | 6493 |
| 1.58K | 1581 | 3.74K | 3741 | 8.87K | 8871 | 21.0K | 2102 | 49.9K | 4992 | 118K | 1183 | 280K | 2803 | 665K | 6653 |
| 1.62K | 1621 | 3.83K | 3831 | 9.09K | 9091 | 21.5K | 2152 | 51.1K | 5112 | 121K | 1213 | 287K | 2873 | 681K | 6813 |
| 1.65K | 1651 | 3.92K | 3921 | 9.31K | 9311 | 22.1K | 2212 | 52.3K | 5232 | 124K | 1243 | 294K | 2943 | 698K | 6983 |
| 1.69K | 1691 | 4.02K | 4021 | 9.53K | 9531 | 22.6K | 2262 | 53.6K | 5362 | 127K | 1273 | 301K | 3013 | 715K | 7153 |
| 1.74K | 1741 | 4.12K | 4121 | 9.76K | 9761 | 23.2K | 2322 | 54.9K | 5492 | 130K | 1303 | 309K | 3093 | 732K | 7323 |
| 1.78K | 1781 | 4.22K | 4221 | 10.0K | 1002 | 23.7K | 2372 | 56.2K | 5622 | 133K | 1333 | 316K | 3163 | 750K | 7503 |
| 1.82K | 1821 | 4.32K | 4321 | 10.2K | 1022 | 24.3K | 2432 | 57.6K | 5762 | 137K | 1373 | 324K | 3243 | 768K | 7683 |
| 1.87K | 1871 | 4.42K | 4421 | 10.5K | 1052 | 24.9K | 2492 | 59.0K | 5902 | 140K | 1403 | 332K | 3323 | 787K | 7873 |
| 1.91K | 1911 | 4.53K | 4531 | 10.7K | 1072 | 25.5K | 2552 | 60.4K | 6042 | 143K | 1433 | 340K | 3403 | 806K | 8063 |
| 1.96K | 1961 | 4.64K | 4641 | 11.0K | 1102 | 26.1K | 2612 | 61.9K | 6192 | 147K | 1473 | 348K | 3483 | 825K | 8253 |
| 2.00K | 2001 | 4.75K | 4751 | 11.3K | 1132 | 26.7K | 2672 | 63.4K | 6342 | 150K | 1503 | 357K | 3573 | 845K | 8453 |
| 2.05K | 2051 | 4.87K | 4871 | 11.5K | 1152 | 27.4K | 2742 | 64.9K | 6492 | 154K | 1543 | 365K | 3653 | 866K | 8663 |
| 2.10K | 2101 | 4.99K | 4991 | 11.8K | 1182 | 28.0K | 2802 | 66.5K | 6652 | 158K | 1583 | 374K | 3743 | 887K | 8873 |
| 2.15K | 2151 | 5.11K | 5111 | 12.1K | 1212 | 28.7K | 2872 | 68.1K | 6812 | 162K | 1623 | 383K | 3833 | 909K | 9093 |
| 2.21K | 2211 | 5.23K | 5231 | 12.4K | 1242 | 29.4K | 2942 | 69.8K | 6982 | 165K | 1653 | 392K | 3923 | 931K | 9313 |
| 2.26K | 2261 | 5.36K | 5361 | 12.7K | 1272 | 30.1K | 3012 | 71.5K | 7152 | 169K | 1693 | 402K | 4023 | 953K | 9533 |
| 2.32K | 2321 | 5.49K | 5491 | 13.0K | 1302 | 30.9K | 3092 | 73.2K | 7322 | 174K | 1743 | 412K | 4123 | 976K | 9763 |
| | | | | | | | | | | | | | | 1M | 1004 |

** All values shown above are standard resistance values, other values could also be provided on a case to case basis (MOQ requested)

** 以上所有阻值都是标准阻值，其他阻值可以特别提供，但有相应 MOQ 之要求。



The standard Part No. includes 14 digits with the following explanation (标准料号包括 14 位数字, 注释如下):

1. 1st~4th digits (第 1 位 ~ 第 4 位):
 - a) This is to indicate the SMD Resistor size. Example (表示晶片电阻的尺寸, 例如): 1206, TC05 or HV03;
 - b) For Resistor Network & Coated type, the 1st~3rd digits are to indicate the product type and the 4th digit is the special feature. Example: RNLA = Resistor Network Circuit A type; CFRF = Carbon Film Fixed Resistors Non-Flame type; MORI = Metal Oxide Film Fixed Resistor Non-Inductive type. 网络电阻和涂装型电阻第 1 位到第 3 位表示产品类型, 第 4 位表示特殊形态, 如: RNLA = 网络电阻 A 型; CFRF = 不燃性碳膜电阻器; MORI = 无感型金属氧化膜电阻器。
 - c) For Cement Fixed Resistors, these 4 digits are to indicate the product type but if the product type has only 3 digits, the 4th digit will be "0". Example: PRW0=PRW type; PRWC=PRWC type. 水泥型前 4 位表示产品类型, 如果产品只有 3 个字母, 第 4 位为 0, 例: PRW0=PRW 型; PRWC=PRWC 型。

2. 5th~6th digits (第 5 位 ~ 第 6 位):
 - a) This is to indicate the wattage or power rating. To distinguish the sizes and the numbers, the following codes are used, and please refer to the following chart for details: W = Normal Size; S = Small Size; U = Ultra Small Size; "1"~"G" to denotes "1"~"16" as Hexadecimal: 表示产品标识功率, 为区别不同尺寸, 同时使用以下字母, 如: W = 正常尺寸; S = 小尺寸; U = 超小尺寸; "1"~"G" 代表 "1"~"16" 为 16 进制。

1/16W ~ 1/2W (<1W)

| Wattage 功率 | 1/2 | 1/3 | 1/4 | 1/5 | 1/6 | 1/7 | 1/8 | 1/9 | 1/10 | 1/11 | 1/12 | 1/13 | 1/14 | 1/15 | 1/16 |
|-----------------------|-----|-----|-----|-----|-----|-----|-----|-----|------|------|------|------|------|------|------|
| Normal Size 正常尺寸 | W2 | W3 | W4 | W5 | W6 | W7 | W8 | W9 | WA | WB | WC | WD | WE | WF | WG |
| Small Size 小尺寸 | S2 | S3 | S4 | S5 | S6 | S7 | S8 | S9 | SA | SB | SC | SD | SE | SF | SG |
| Ultra Small Size 超小尺寸 | U2 | U3 | U4 | U5 | U6 | U7 | U8 | U9 | UA | UB | UC | UD | UE | UF | UG |

1W ~ 16W (≥1W)

| Wattage 功率 | 1 | 2 | 3 | 4 | 5 | 6 | 7 | 8 | 9 | 10 | 11 | 12 | 13 | 14 | 15 | 16 |
|-----------------------|----|----|----|----|----|----|----|----|----|----|----|----|----|----|----|----|
| Normal Size 正常尺寸 | 1W | 2W | 3W | 4W | 5W | 6W | 7W | 8W | 9W | AW | BW | CW | DW | EW | FW | GW |
| Small Size 小尺寸 | 1S | 2S | 3S | 4S | 5S | 6S | 7S | 8S | 9S | AS | BS | CS | DS | ES | FS | GS |
| Ultra Small Size 超小尺寸 | 1U | 2U | 3U | 4U | 5U | 6U | 7U | 8U | 9U | AU | BU | CU | DU | EU | FU | GU |

- b) For power rating less than 1W, the 5th digit will be the letters W, S or U to represent the size required & the 6th digit will be a number or a letter code. Example: WA = 1/10W; U2 = 1/2W-SS (功率小于 1 瓦, 第 5 位用 W, S 或 U 表示尺寸要求, 第 6 位将是数字或字母, 例: WA = 1/10W; U2 = 1/2W-SS.)
 - c) For power rating of 1W to 16W, the 5th digit will be a number or a letter code and the 6th digit will be the letters of W, S or U. Example: AW = 10W; 3S = 3W-S. 当功率为 1 到 16 瓦, 第 5 位将是数字或字母, 第 6 位是 W, S 或 U. 例: AW = 10W; 3S = 3W-S.
 - d) For power rating between 20W to 99W, the 5th & 6th digits will show the whole numbers of the power rating itself. Example: 20 = 20W; 75 = 75W. 当功率在 20 瓦 ~99 瓦之间第 5 位至第 6 位全部表示功率. 例: 20 = 20W; 75 = 75W.
 - e) For power rating of 100W & over, the 5th & 6th digits will be indicated with "00" and the actual wattage being indicated at the last 3 digits (12th~14th) of the Part No. 当大于 100 瓦时第 5 位和第 6 位表示为 "00" 实际功率表示在料号最后 3 位 (12 位 ~ 14 位)
 - f) For special power ratings, the following codes are to be used (特殊功率用下列数字表示):

| | | | | |
|---|--|---------------|---------------|----------------|
| 1). WH = 1/32W (10P8 Chip Network 网络电阻) | 2). 07 = 3/4WS [Chip 2010 size (晶片 2010 尺寸)] | | | |
| 3). 04 = 0.4W-SS (0.4 watt Ultra Small size 超小尺寸) | 4). 06 = 0.6W-S (0.6 watt Small size 小尺寸) | | | |
| 5). 2A = 2.5W | 6). 6A = 6.5W | 7). WK = 2/3W | 8). WJ = 1.5W | 9). 1.25W = 1Q |
 - g) For Resistor Network, since the power rating is fixed as 1/8W for A circuit & 1/5W for B circuit, the 5th & 6th digit is to be used to denote the number of pins required. Example: 09 = 9pins; 12 = 12pins. (网络电阻功率固定为 1/8W 或 1/5W, 故第 5 位和第 6 位用来表示所需要的 pins 数. 例: 09 = 9pins; 12 = 12pins.)
 - h) For Jumper Wires the 5th & 6th digits will be indicated with "00". (跳线电阻的第 5 位、第 6 位用 "00" 来表示)
 - i) For Thin Film Chip Resistors, these 2 digits will be used to indicate the requested Temperature coefficient: 对于薄膜晶片电阻产品, 这两位用来表示产品的温度系数要求:

| | | | | |
|---------------|----------------|----------------|----------------|----------------|
| 1). 05 = 5PPM | 2). 10 = 10PPM | 3). 15 = 15PPM | 4). 25 = 25PPM | 5). 50 = 50PPM |
|---------------|----------------|----------------|----------------|----------------|
3. The 7th digit is to denote the Resistance Tolerance. The following letter code is to be used for indicating the standard Resistance Tolerance. As for Metal Film Fixed Resistor products, it is also to denote the standard PPM as follows (第 7 位表示阻值误差. 下列数码用来表示标准误差, 用于金属膜产品时, 同时用来表示标准 PPM, 如下):

| | | |
|---------------------------|-------------------------|-------------------|
| B = ±0.1% (15PPM) | G = ±2% (100PPM) | A = ±0.05% |
| C = ±0.25% (25PPM) | J = ±5% (200PPM) | T = ±0.01% |
| D = ±0.5% (50PPM) | K = ±10% | |
| F = ±1% (50PPM) | | |

Remark: if it is not one of the above standard "tolerance-TCR", the requirement should be clearly stated when placing order. Example: ±1% (25PPM), the 7th digit still shows "F" but separately note the requirement of "25PPM"

注: 如果一个不是上述标准 "公差-PPM" 的要表示清楚 例: ±1% (25PPM), 第 7 位要标示 "F" 并另注 "25PPM"

4. The 8th to 11th digits is to denote the Resistance Value (第 8 位 ~ 第 11 位表示阻值):

- For the standard resistance values of E-24 series in 5% & 10% tolerance, the 8th digit is "0", the 9th & 10th digits are to denote the significant figures of the resistance and the 11th digit is the number of zeros following (对于 E-24 系列的 5%、10% 产品, 第 8 位数是 0, 第 9 位数和第 10 位数表示阻值的有效数, 第 11 位表示有几个 0.)
- For the standard resistance values of E-96 series in ≤2% tolerance, the 8th digit to the 10th digits are to denote the significant figures of the resistance and the 11th digit is the number of zeros following (对于 E-96 系列 ≤2% 的产品, 第 8 位数到第 10 位数表示阻值的有效数, 第 11 位数表示有几个 0.)
- For the code to the significant figures to E-24 & E-96 series, please refer to page 170 & 171 of the standards Resistance Value list.(有效数 E-24 和 E-96 系列, 请参考 170 页和 171 页标准阻值表)
- The following numbers and the letter codes is to be used to indicate the number of zeros in the 11th digit:

以下数字及字母用来表示第 11 位数有几个 0:

| | | | | | | |
|----------------------|----------------------|----------------------|----------------------|----------------------|----------------------|---------------------|
| 0 = 10 ⁰ | 1 = 10 ¹ | 2 = 10 ² | 3 = 10 ³ | 4 = 10 ⁴ | 5 = 10 ⁵ | 6 = 10 ⁶ |
| J = 10 ⁻¹ | K = 10 ⁻² | L = 10 ⁻³ | M = 10 ⁻⁴ | N = 10 ⁻⁵ | P = 10 ⁻⁶ | |

- For Cement Resistors the 8th digit will be coded with "W" or "P" to denote Wire-wound type or Power Film type respectively of the Cement Fixed Resistor product. The 9th to 11th please refer to point 4.a (水泥电阻第 8 位数 "W" 或 "P" 用来表示绕线型或切割型, 第 9 位数到第 11 位数请参考 4.a)

Example (例):

| <u>E-24 series 系列</u> | <u>E-96 series 系列</u> | <u>Cement Resistors 水泥型固定电阻值</u> |
|-----------------------|-----------------------|------------------------------------|
| 0120 = 12 ohm | 1210 = 121 ohm | W120 = 12 ohm Wire-wound type 绕线型 |
| 0123 = 12K ohm | 1302 = 13K ohm | W12J = 1.2 ohm Wire-wound type 绕线型 |
| 012J = 1.2 ohm | 196J = 19.6 ohm | P273 = 27 kohm Powe Film type 切割型 |

5. The 12th, 13th & 14th digits (第 12 位数、13 位数和 14 位数):

- The 12th digit is to denote the Packaging type with the following codes (第 12 位数表示包装方式, 采用如下代码):
 A = Tape / Box (Ammo Pack) [编带 / 盒装 (带装)] C = Bulk in Cassette (for Chip product)[散装盒 (晶片产品)]
 B = Bulk / Box (散装 / 盒装) T = Tape / Reel (编带 / 卷装) P = Tape / Box of PT-26 product [编带 / 盒装 (PT-26 产品)]
- The 13th digit is normally to indicate the Packing Quantity of Tape/Box or Tape/Reel packaging types. Except for Chip products Bulk packing, this digit should be filled "0" or other products with "Bulk/Box packaging requirement. The following letter codes is to be used for some packaging quantities (第 13 位数一般表示包装数量对于 T/B 或 T/R 型, 除了晶片散装外, 其他产品的散装包装用 "0" 表示数量。下列字母说明包装数量).
 A = 500pcs (只) B = 2,500pcs (只) C = 10,000pcs (只) N = 12,500pcs (只) E = 15,000pcs (只)
 D = 20,000pcs (只) G = 25,000pcs (只) L = 45,000pcs (只) H = 50,000pcs (只) J = 60,000pcs (只)

Example (例):

| <u>CHIP product (晶片产品)</u> | <u>Other products (其它产品)</u> |
|------------------------------|--------------------------------|
| TD = T/R-20,000 | A5 = T/B-5,000 |
| TE = T/R-15,000 | TB = T/R-2,500 |
| T4 = T/R-4,000 | B0 = B/B (可提供标准包装) |

- For the Forming type products, the 13th & 14th digits are used to denote the forming types of the product with the following letter codes (对于成型产品第 13 位数和第 14 位数用来表示成型产品, 如下字母表示):

| | |
|--|----------------|
| MF = M type with Flattened lead wire (M 型打扁加工) | F0 = F type 型 |
| MK = M type with Kinked lead wire (M 型打弯加工) | F1 = F1 type 型 |
| ML = M type with normal lead wire (M 型加工) | F2 = F2 type 型 |
| MC = M type with kinked lead wire (M 型打弯加工) | F3 = F3 type 型 |

- For power rating over 100watt, the 12th to the 14th digits are to denote the actual wattage of the products (当功率超过 100W 时, 它的第 12 位数到 14 位数用来表示产品的实际功率):

Example (例): 100 = 100watt (瓦) 150 = 150watt (瓦) 225 = 225watt (瓦)

- For some products, the 14th digit alone can use to denote special features or additional information with the following codes

(对于某些产品第 14 位可以显示特性和附加信息, 如下字母):

| | | |
|----------------------------------|--|--|
| P = Panasert type (Panasert 型) | 1 = Avisert 1 type (Avisert 1 型) | 2 = Avisert 2 type (Avisert 2 型) |
| 3 = Avisert 3 type (Avisert 3 型) | A = CO 1/4W - A type (切割型 CO 1/4W-A 型) | B = CO 1/4W - B type (切割型 CO 1/4W-B 型) |

E = used to denote the "Environment Protection, lead Free type" of SMD category resistors (now, this became the Standard type of SMD) (晶片电阻, 晶片排阻及网络电阻器 "环保无铅型")

4 Band Color Code (available for CFR, MOR, KNP & 2% or 5% of MF products)

4 道色码 (适用于 CFR, MOR, KNP & 2% 或 5% of MF 产品)

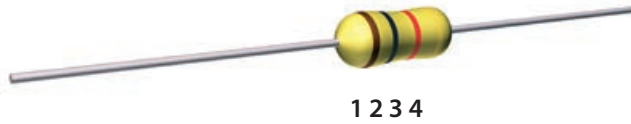

4th Band
第四道

| | |
|----------|--------|
| Red 红 | = ±2% |
| Gold 金 | = ±5% |
| Silver 银 | = ±10% |

1st Band
第一道

| | |
|----------|-----|
| Black 黑 | = 0 |
| Brown 棕 | = 1 |
| Red 红 | = 2 |
| Orange 橙 | = 3 |
| Yellow 黄 | = 4 |
| Green 绿 | = 5 |
| Blue 蓝 | = 6 |
| Violet 紫 | = 7 |
| Gray 灰 | = 8 |
| White 白 | = 9 |

2nd Band
第二道

| | |
|----------|-----|
| Black 黑 | = 0 |
| Brown 棕 | = 1 |
| Red 红 | = 2 |
| Orange 橙 | = 3 |
| Yellow 黄 | = 4 |
| Green 绿 | = 5 |
| Blue 蓝 | = 6 |
| Violet 紫 | = 7 |
| Gray 灰 | = 8 |
| White 白 | = 9 |

3rd Band
第三道

| | |
|----------|--|
| Black 黑 | = Multiply by 乘积倍数 1 (10^0) |
| Brown 棕 | = Multiply by 乘积倍数 10 (10^1) |
| Red 红 | = Multiply by 乘积倍数 100 (10^2) |
| Orange 橙 | = Multiply by 乘积倍数 1,000 (10^3) |
| Yellow 黄 | = Multiply by 乘积倍数 10,000 (10^4) |
| Green 绿 | = Multiply by 乘积倍数 100,000 (10^5) |
| Blue 蓝 | = Multiply by 乘积倍数 1,000,000 (10^6) |
| Violet 紫 | = Multiply by 乘积倍数 10,000,000 (10^7) |
| Gold 金 | = Multiply by 乘积倍数 0.1 (10^{-1}) |
| Silver 银 | = Multiply by 乘积倍数 0.01 (10^{-2}) |

5 Band Color Code (available for MF 1% & FRN Products)

5 道色码 (适用于 MF 1% & FRN 产品)



5th Band
第五道

| | |
|----------|----------|
| Violet 紫 | = ±0.1% |
| Blue 蓝 | = ±0.25% |
| Green 绿 | = ±0.5% |
| Brown 棕 | = ±1% |

1st Band
第一道

| | |
|----------|-----|
| Black 黑 | = 0 |
| Brown 棕 | = 1 |
| Red 红 | = 2 |
| Orange 橙 | = 3 |
| Yellow 黄 | = 4 |
| Green 绿 | = 5 |
| Blue 蓝 | = 6 |
| Violet 紫 | = 7 |
| Gray 灰 | = 8 |
| White 白 | = 9 |

2nd Band
第二道

| | |
|----------|-----|
| Black 黑 | = 0 |
| Brown 棕 | = 1 |
| Red 红 | = 2 |
| Orange 橙 | = 3 |
| Yellow 黄 | = 4 |
| Green 绿 | = 5 |
| Blue 蓝 | = 6 |
| Violet 紫 | = 7 |
| Gray 灰 | = 8 |
| White 白 | = 9 |

3rd Band
第三道

| | |
|----------|-----|
| Black 黑 | = 0 |
| Brown 棕 | = 1 |
| Red 红 | = 2 |
| Orange 橙 | = 3 |
| Yellow 黄 | = 4 |
| Green 绿 | = 5 |
| Blue 蓝 | = 6 |
| Violet 紫 | = 7 |
| Gray 灰 | = 8 |
| White 白 | = 9 |

4th Band
第四道

| | |
|----------|--|
| Black 黑 | = Multiply by 乘积倍数 1 (10^0) |
| Brown 棕 | = Multiply by 乘积倍数 10 (10^1) |
| Red 红 | = Multiply by 乘积倍数 100 (10^2) |
| Orange 橙 | = Multiply by 乘积倍数 1,000 (10^3) |
| Yellow 黄 | = Multiply by 乘积倍数 10,000 (10^4) |
| Green 绿 | = Multiply by 乘积倍数 100,000 (10^5) |
| Blue 蓝 | = Multiply by 乘积倍数 1,000,000 (10^6) |
| Violet 紫 | = Multiply by 乘积倍数 10,000,000 (10^7) |
| Gold 金 | = Multiply by 乘积倍数 0.1 (10^{-1}) |
| Silver 银 | = Multiply by 乘积倍数 0.01 (10^{-2}) |

Ceramic Rods For Resistors (电阻器用陶瓷基体)

| | | | |
|--|---------------------|-----|--|
|  | Ceramic Rod (瓷棒) | 144 | 1.3×2.7, 1.7×5.2, 1.7×5.5, 1.7×6.0, 2.0×7.5, 2.0×8.0, 2.5×8.0, 3.0×8.0, 3.0×10, 3.5×10, 4.0×14, 5.0×16, 7.0×23 |
|--|---------------------|-----|--|

Capped & Sorted Ceramic Rod (组帽棒)

| | | | |
|--|------------------------------------|-----|--|
|  | White Capped Ceramic Rod (组帽瓷棒) | 146 | 1.3×2.7, 1.7×5.2, 1.7×5.5, 1.7×6.0, 2.0×7.5, 2.0×8.0, 2.5×8.0, 3.0×8.0, 3.0×10, 3.5×10, 4.0×14, 5.0×16, 7.0×23 |
|--|------------------------------------|-----|--|

| | | | |
|--|---|-----|--|
|  | Carbon Film Capped Ceramic Rod (碳膜组帽棒) | 148 | 1.3×2.7, 1.7×5.2, 1.7×5.5, 1.7×6.0, 2.0×7.5, 2.0×8.0, 2.5×8.0, 3.0×8.0, 3.0×10, 3.5×10, 4.0×14, 5.0×16, 7.0×23 |
|--|---|-----|--|

| | | | |
|--|---|-----|--|
|  | Metal Film Capped Ceramic Rod (金属膜组帽棒) | 150 | 1.3×2.7, 1.7×5.2, 1.7×5.5, 1.7×6.0, 2.0×7.5, 2.0×8.0, 2.5×8.0, 3.0×8.0, 3.0×10, 3.5×10, 4.0×14, 5.0×16, 7.0×23 |
|--|---|-----|--|

| | | | |
|--|---|-----|--|
|  | Metal Oxide Film Capped Ceramic Rod (金属氧化膜组帽棒) | 152 | 1.3×2.7, 1.7×5.2, 1.7×5.5, 1.7×6.0, 2.0×7.5, 2.0×8.0, 2.5×8.0, 3.0×8.0, 3.0×10, 3.5×10, 4.0×14, 5.0×16, 7.0×23 |
|--|---|-----|--|

| | | | |
|--|--|-----|--|
|  | Capped Metal Glaze Film Rod (玻璃釉膜组帽棒) | 154 | 1.3×2.7, 1.7×5.2, 1.7×5.5, 1.7×6.0, 2.0×7.5, 2.0×8.0, 2.5×8.0, 3.0×8.0, 3.0×10, 3.5×10, 4.0×14, 5.0×16 |
|--|--|-----|--|

| | | | |
|--|--|-----|--|
|  | Capped Chemical Deposited Film Rod (化学沉积膜组帽棒) | 156 | 1.3×2.7, 1.7×5.2, 1.7×5.5, 1.7×6.0, 2.0×7.5, 2.0×8.0, 2.5×8.0, 3.0×8.0, 3.0×10, 3.5×10, 4.0×14, 5.0×16, 7.0×23 |
|--|--|-----|--|

| | | | |
|---|------------------------|-----|------------------|
|  | Zero Ohm Rod (零欧姆棒) | 158 | 1.3×2.7, 1.7×5.2 |
|---|------------------------|-----|------------------|

Tin-Plated Steel Cap (镀锡铁帽)

| | | | |
|--|--------------------------------|-----|---|
|  | Tin-Plated Steel Cap (镀锡铁帽) | 160 | Ø1.26, Ø1.64, Ø1.95, Ø2.45, Ø2.90, Ø3.41, Ø3.91, Ø4.90, Ø6.90 |
|--|--------------------------------|-----|---|

Ceramic Case (瓷壳)

| | | | |
|--|----------------------------|-----|------------------------------------|
|  | PRW series Case (PRW 系列瓷壳) | 161 | 2W, 3W, 5W, 7W, 10W, 15W, 20W, 25W |
| | PRM series Case (PRM 系列瓷壳) | 161 | 2W, 3W, 5W, 7W, 10W, 15W, 20W, 25W |
| | PRV series Case (PRV 系列瓷壳) | 161 | 3W, 5W, 7W, 10W, 15W, 20W |
| | PRT series Case (PRT 系列瓷壳) | 161 | 10W, 15W, 20W, 30W, 40W |
| | PFA series Case (PFA 系列瓷壳) | 161 | 2W, 3W, 5W, 7W, 10W |

Packing (包装)

| | | |
|--|---------------------------|-----|
|  | Ceramic Rod (瓷棒) | 163 |
| | Filmed & Capped Rod (组帽棒) | 163 |
| | Zero Ohm Rod (零欧姆棒) | 164 |
| | Tin-Plated Steel Cap (铁帽) | 164 |

| Material 材质 | | Alumina 氧化铝瓷 | | | | | | | |
|--|-------------------------------------|---|------------------------------------|------------------------------------|------------------------------------|------------------------------------|------------------------------------|--|------------------------------------|
| Product Code 产品代号 | | FS-25 | FS-55 | FS-70 | FS-75 | FS-80 | FS-85 | FS-92 | FS-98 |
| Chemical Analysis 主成份 | | AL ₂ O ₃ 25% | AL ₂ O ₃ 55% | AL ₂ O ₃ 70% | AL ₂ O ₃ 75% | AL ₂ O ₃ 80% | AL ₂ O ₃ 85% | AL ₂ O ₃ 92% | AL ₂ O ₃ 98% |
| Appearance 外观 | | Dense 致密质 | Dense 致密质 | Dense 致密质 | Dense 致密质 | Dense 致密质 | Dense 致密质 | Dense 致密质 | Dense 致密质 |
| Color 呈色 | | White 白色 | White 白色 | White 白色 | White 白色 | White 白色 | White 白色 | White 白色 | White 白色 |
| Features 特征 | | Good Heat Resistance, High Thermal Conductivity 耐热性优良, 热传导性高 | | | | | | | |
| Main Use 主要用途 | | Wire-wound Resistor 绕线电阻器用 | | | Film Resistor 膜式电阻器用 | | | Small-size & High power resistor 大功率小型化电阻器用 | |
| | | | | | | | | | |
| | | | | | | | | | |
| Water Absorption 吸水率 | % | ≤ 0.02 | ≤ 0.02 | ≤ 0.01 | ≤ 0.01 | ≤ 0.01 | ≤ 0.01 | < 0.02 | < 0.02 |
| Bulk Density 体积密度 | g / cm ³ | ≥ 2.3 | ≥ 2.8 | ≥ 3.1 | ≥ 3.2 | ≥ 3.2 | ≥ 3.45 | ≥ 3.6 | ≥ 3.8 |
| Thermal Expansion Coefficient 热膨胀系数 | ×10 ⁻⁶ /°C (20-500°C) | > 4.0 | > 5.5 | > 6.1 | > 6.7 | > 7.0 | > 7.3 | > 7.0 | > 7.7 |
| Thermal Conductivity 热传导率 | Cal/ cm.sec. °C | > 0.003 | > 0.008 | > 0.011 | > 0.020 | > 0.015 | > 0.023 | > 0.040 | > 0.050 |
| Dielectric Strength 绝缘强度 | KV/mm | > 9 | > 10 | > 10 | > 10 | > 10 | > 10 | > 10 | > 10 |
| Dielectric Constant 绝缘常数 | 1MHZ | 9.5 | 9.5 | 9.5 | 9.5 | 9.5 | 9.5 | 9.5 | 9.5 |
| Loss Rate 损失率 | 1MHZ | < 0.001 | < 0.001 | < 0.001 | < 0.001 | < 0.001 | < 0.0001 | 0.0001 | 0.0001 |
| Anti-cross break strength 抗折力 | Kg | > 9 | > 10 | > 12 | > 12 | > 16 | > 16 | > 16 | > 16 |



Feature (特性)

- Aluminum Content 70%, 80%, 85%. (70%, 80%, 85% 含铝量瓷棒)
- Electronic Ceramic parts in superior performance. (属于优良电子陶瓷产品)
- Suitable for producing in different types of resistance film.
(适合生产各种膜层的电阻)

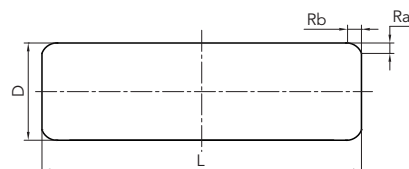

Dimension (尺寸) (单位: mm)

| NO | Size 规格 | D 直径 | L 长度 | R | |
|----|---------|--|-------------------------------------|-------------|-------------|
| | | | | (Ra MIN 最小) | (Rb MAX 最大) |
| 1 | 1.3×2.7 | 1.30±0.02 | 2.7±0.1 | 0.15 | 0.45 |
| 2 | 1.7×5.2 | 1.70±0.03 | 5.2 ^{+0.1} _{-0.2} | 0.20 | 0.65 |
| 3 | 1.7×5.5 | 1.70±0.03 | 5.5±0.2 | 0.20 | 0.65 |
| 4 | 1.7×6.0 | 1.70±0.03 | 6.0±0.2 | 0.20 | 0.65 |
| 5 | 2.0×7.5 | 2.00 ^{+0.04} _{-0.03} | 7.5±0.2 | 0.25 | 0.75 |
| 6 | 2.0×8.0 | 2.00±0.03 | 8.0±0.2 | 0.25 | 0.75 |
| 7 | 2.5×8.0 | 2.50±0.04 | 8.0±0.2 | 0.28 | 0.80 |
| 8 | 3.0×8.0 | 3.00±0.04 | 8.0±0.2 | 0.30 | 1.00 |
| 9 | 3.0×10 | 3.00±0.04 | 10.0±0.3 | 0.30 | 1.00 |
| 10 | 3.5×10 | 3.50 ^{+0.04} _{-0.05} | 10.0±0.3 | 0.30 | 1.00 |
| 11 | 4.0×14 | 4.00±0.05 | 14.0±0.3 | 0.35 | 1.20 |
| 12 | 5.0×16 | 5.00±0.05 | 16.0±0.3 | 0.45 | 1.40 |
| 13 | 7.0×23 | 7.00±0.07 | 23.0±0.5 | 0.75 | 2.00 |

Remark: any special dimensions (4.0×12, 4.0×22, 4.0×39...) and Aluminum Content can be produced according to customer's request.
备注: 特殊规格的尺寸 (4.0×12, 4.0×22, 4.0×39.....) 及公差和含铝量可以按客户的要求来生产。

Specification (产品规格)

| Type (瓷类) | Size (规格) |
|-------------------|--|
| FS-25 FS-55 FS-70 | 1.7×5.2, 1.7×5.5, 1.7×6.0, 2.0×7.5, 2.0×8.0, 2.5×8.0, 3.0×8.0, 3.5×10, 4.0×14, 5.0×16, 7.0×23 |
| FS-75 FS-80 | 1.3×2.7, 1.7×5.2, 1.7×5.5, 1.7×6.0, 2.0×7.5, 2.0×8.0, 2.5×8.0, 3.0×8.0, 3.5×10, 4.0×14, 5.0×16, 7.0×23 |
| FS-85 RS-92 FS-98 | 1.3×2.7, 1.7×5.2, 1.7×5.5, 1.7×6.0, 2.0×7.5, 2.0×8.0, 2.5×8.0, 3.0×8.0, 3.5×10, 4.0×14, 5.0×16, 7.0×23 |

Ordering Procedure (Example:OPD217520000FS)

订购方式 (例如: 膜层用 1.7×5.2 80% 瓷棒)

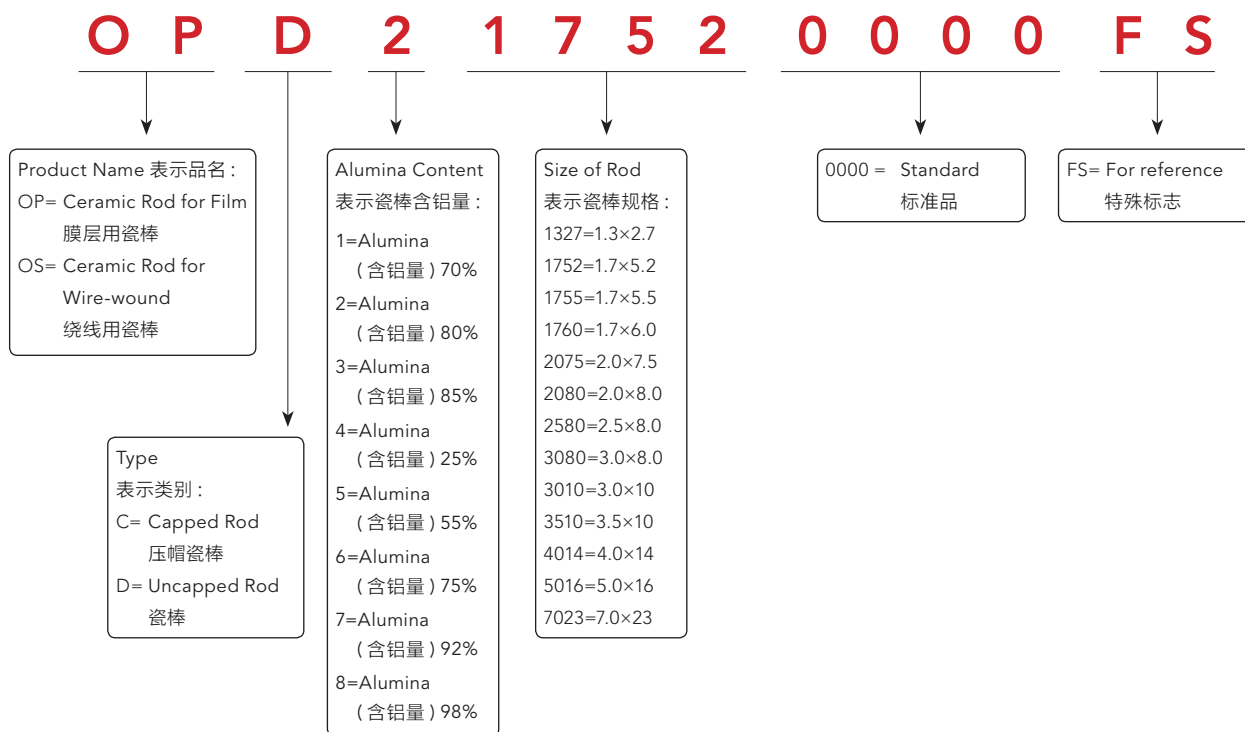

Remark: can produce other Alumina content product according to customer's request.
备注: 可根据客户的要求订制其他含铝量的产品。



Feature (特性)

- Aluminum Content 70%, 80%, 85% (70%, 80%, 85% 含铝量白瓷棒)
- Electronic Ceramic parts in superior performance (属于优良的电子陶瓷产品)
- Suitable for producing in different types of Wire-wound resistors (适合生产绕线电阻)

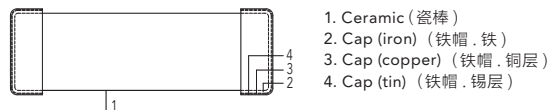

Dimension (尺寸) (单位: mm)

| NO | Size 规格 | Capped Ceramic Rod 压帽瓷棒 | | MIN PULLING FORCE 最小拉力 (KG) |
|----|---------|-------------------------|-------------|--------------------------------|
| | | D 直径 | L 长度 | |
| 1 | 1.3×2.7 | 1.54~1.66 | 2.86~3.16 | 2 |
| 2 | 1.7×5.2 | 2.03~2.17 | 5.36~5.76 | 3 |
| 3 | 1.7×5.5 | 2.03~2.17 | 5.66~6.16 | 3 |
| 4 | 1.7×6.0 | 2.03~2.17 | 6.16~6.66 | 3 |
| 5 | 2.0×7.5 | 2.33~2.58 | 7.66~8.27 | 5 |
| 6 | 2.0×8.0 | 2.33~2.57 | 8.16~8.77 | 5 |
| 7 | 2.5×8.0 | 2.82~3.08 | 8.16~8.77 | 6 |
| 8 | 3.0×8.0 | 3.32~3.58 | 8.16~8.77 | 6 |
| 9 | 3.0×10 | 3.32~3.58 | 10.06~10.89 | 6 |
| 10 | 3.5×10 | 3.81~4.08 | 10.06~10.89 | 6 |
| 11 | 4.0×14 | 4.31~4.59 | 14.06~14.89 | 6 |
| 12 | 5.0×16 | 5.41~5.59 | 16.16~16.89 | 6 |
| 13 | 7.0×23 | 7.39~7.61 | 22.96~24.09 | 6 |

Ordering Procedure (Example: OSC14014000000)

订购方式 (例如: 4.0×14 规格 70% 组帽瓷棒)

O S C 1 4 0 1 4 0 0 0 0 0 0

Product Name
表示品名:
OS= Ceramic Rod for
Wire-wound
绕线用瓷棒

Type 表示类别:
C= Capped Ceramic Rod 组帽

Alumina Content
表示瓷棒含铝量:
1=Alumina (含铝量) 70%
2=Alumina (含铝量) 80%
3=Alumina (含铝量) 85%
4=Alumina (含铝量) 25%
5=Alumina (含铝量) 55%
6=Alumina (含铝量) 75%
7=Alumina (含铝量) 92%
8=Alumina (含铝量) 98%

Size of Rod 表示瓷棒规格:
1327=1.3×2.7 1752=1.7×5.2
1755=1.7×5.5 1760=1.7×6.0
2075=2.0×7.5 2080=2.0×8.0
2580=2.5×8.0 3080=3.0×8.0
3010=3.0×10 3510=3.5×10
4014=4.0×14 5016=5.0×16
7023=7.0×23

0=Standard 标准品

Remark: can produce other Alumina content product according to customer's request.
备注: 可根据客户的要求订制其他含铝量的产品。

| Type 膜层类型 | Characteristic 膜层特点 | Resistance range 电阻值范围 (Ω) | T.C.R. 电阻温度系数 (ppm/°C) | Limit of short time over load 短时间过载变化率 |
|--|---|----------------------------------|------------------------------|--|
| Film ceramic rods of carbon film resistor 碳膜 | Conductive film made of high-heat temperature decompose carbon material 高温热分解碳质导电膜层 | 1Ω ~2.5Ω | ±300 | ≤ (1%+0.05Ω) |
| | Ceramic rod with high-conduction material 高导热材料基体 | 2.6Ω ~800Ω | ±450 | |
| | Low cost 低成本 | 801Ω ~5KΩ | 0 ~ -700 | |
| | | 5.1KΩ ~ 120KΩ | 0 ~ -1500 | |
| Film ceramic rods of metal film resistor 金属膜 | Vacuum sputtering film ceramic rod adopted 采用真空溅射完成膜层 | 0.5Ω ~20KΩ | ±15 | ≤ (0.5%+0.05Ω) |
| | Ceramic rod with high-conduction material 高导热材料基体 | | ±25 | |
| | Low current noise & T.C.R. 低电流噪声、低电阻温度系数 | | ±50 | |
| | Wide resistance range:1Ω ~20KΩ 电阻值范围可达 :1Ω ~20KΩ | | | |
| Film ceramic rods of metal oxide film resistor 金属氧化膜 | Conductive film made of metal oxide fired at high temperature 金属氧化物高温烧成膜层 | 2Ω ~500Ω | ±350 | Normal size 正常尺寸 |
| | Good overload capacity 具有高温负荷能力 | | | ≤ (1%+0.05Ω) |
| | Ceramic rod with high-conduction material 高导热材料基体 | | | Small size 小尺寸 ≤ (2%+0.05Ω) |
| Film ceramic rods of Chemical Deposited Film resistors 化学沉 积膜 | Conductive film made of chemical plated metal 化学镀金属导电膜层 | 0.02Ω ~1.3Ω | ±200 | Normal size 正常尺寸 |
| | Ceramic rod with high-conduction material 高导热材料基体 | | | ≤ (1%+0.05Ω) |
| | Low cost 低成本 | | | Small size 小尺寸 ≤ (2%+0.05Ω) |
| Film ceramic rods of Metal Glaze film resistors 玻璃釉膜 | Conductive film made of high temperature 高温烧成贵金属氧化物导电膜层 | 15Ω ~1.3MΩ | ±100 ±200 | ≤ (1%+0.05Ω) |
| | With high overload capacity 具有高过负荷能力 | | | |
| | Wide resistance range:15Ω ~2.5MΩ 阻值范围 :15Ω ~2.5MΩ | | | |
| | Small T.C.R.: ±100~200ppm/°C 温度系数小 :±100~200ppm/°C | | | |
| 0Ω resistors 零欧电阻 | Conductive film made of chemical plated copper 化学镀铜导电膜层 | ≤ 50mΩ | / | / |
| | Ceramic rod with high-conduction material 高导热材料基体 | | | |
| | Low cost 低成本 | | | |



Feature (特性)

- Filming in CVD technology (采用 CVD 技术成膜)
- Low cost, good performance at High Frequency (低成本, 高频特性好)
- Wide IRV range, can be sorted accurately (初值范围宽, 并可以精准分类)

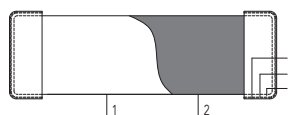

1. Ceramic (瓷棒)
2. Film (膜层)
3. Cap (iron) (铁帽, 铁)
4. Cap (copper) (铁帽, 铜层)
5. Cap (tin) (铁帽, 锡层)

Dimension (尺寸) (单位: mm)

| NO | Size 规格 | Uncapped Filming Rod 着膜棒 | | Capped Filming Rod 组分品 | | MIN PULLING FORCE 最小拉力 (KG) |
|----|---------|--|-------------------------------------|------------------------|-------------|--------------------------------|
| | | D 直径 | L 长度 | D 直径 | L 长度 | |
| 1 | 1.3×2.7 | 1.30±0.02 | 2.7±0.1 | 1.54~1.66 | 2.86~3.16 | 2 |
| 2 | 1.7×5.2 | 1.70±0.03 | 5.2 ^{+0.1} _{-0.2} | 2.03~2.17 | 5.36~5.76 | 3 |
| 3 | 1.7×5.5 | 1.70±0.03 | 5.5±0.2 | 2.03~2.17 | 5.66~6.16 | 3 |
| 4 | 1.7×6.0 | 1.70±0.03 | 6.0±0.2 | 2.03~2.17 | 6.16~6.66 | 3 |
| 5 | 2.0×7.5 | 2.00 ^{+0.04} _{-0.03} | 7.5±0.2 | 2.33~2.58 | 7.66~8.27 | 5 |
| 6 | 2.0×8.0 | 2.00±0.03 | 8.0±0.2 | 2.33~2.57 | 8.16~8.77 | 5 |
| 7 | 2.5×8.0 | 2.50±0.04 | 8.0±0.2 | 2.82~3.08 | 8.16~8.77 | 6 |
| 8 | 3.0×8.0 | 3.00±0.04 | 8.0±0.2 | 3.32~3.58 | 8.16~8.77 | 6 |
| 9 | 3.0×10 | 3.00±0.04 | 10.0±0.3 | 3.32~3.58 | 10.06~10.89 | 6 |
| 10 | 3.5×10 | 3.50 ^{+0.04} _{-0.05} | 10.0±0.3 | 3.81~4.08 | 10.06~10.89 | 6 |
| 11 | 4.0×14 | 4.00±0.05 | 14.0±0.3 | 4.31~4.59 | 14.06~14.89 | 6 |
| 12 | 5.0×16 | 5.00±0.05 | 16.0±0.3 | 5.41~5.59 | 16.16~16.89 | 6 |
| 13 | 7.0×23 | 7.00±0.07 | 23.0±0.5 | 7.39~7.61 | 22.96~24.09 | 6 |

IRV (Initial Resistance Value) Range (初值范围)

| | | | | | |
|-----------|---------|-----------|-------------|-----------|------------|
| 1Ω-2Ω | 8Ω-13Ω | 60Ω-100Ω | 500Ω-800Ω | 4KΩ-7KΩ | 30KΩ-60KΩ |
| 1.5Ω-2.5Ω | 10Ω-20Ω | 80Ω-130Ω | 600Ω-900Ω | 5KΩ-10KΩ | 40KΩ-80KΩ |
| 2Ω-3.5Ω | 15Ω-25Ω | 100Ω-200Ω | 800Ω-1.3KΩ | 6KΩ-12KΩ | 50KΩ-100KΩ |
| 3Ω-5Ω | 20Ω-30Ω | 150Ω-250Ω | 1KΩ-2KΩ | 8KΩ-16KΩ | 60KΩ-120KΩ |
| 4Ω-7Ω | 30Ω-50Ω | 200Ω-400Ω | 1.5KΩ-2.5KΩ | 10KΩ-20KΩ | |
| 5Ω-8Ω | 40Ω-60Ω | 300Ω-500Ω | 2KΩ-4KΩ | 15KΩ-30KΩ | |
| 6Ω-10Ω | 50Ω-80Ω | 400Ω-600Ω | 3KΩ-5KΩ | 20KΩ-40KΩ | |

Ordering Procedure (Example: CRC11752100200)

订购方式 (例如: CR 70% 1.7×5.2 10-20E)

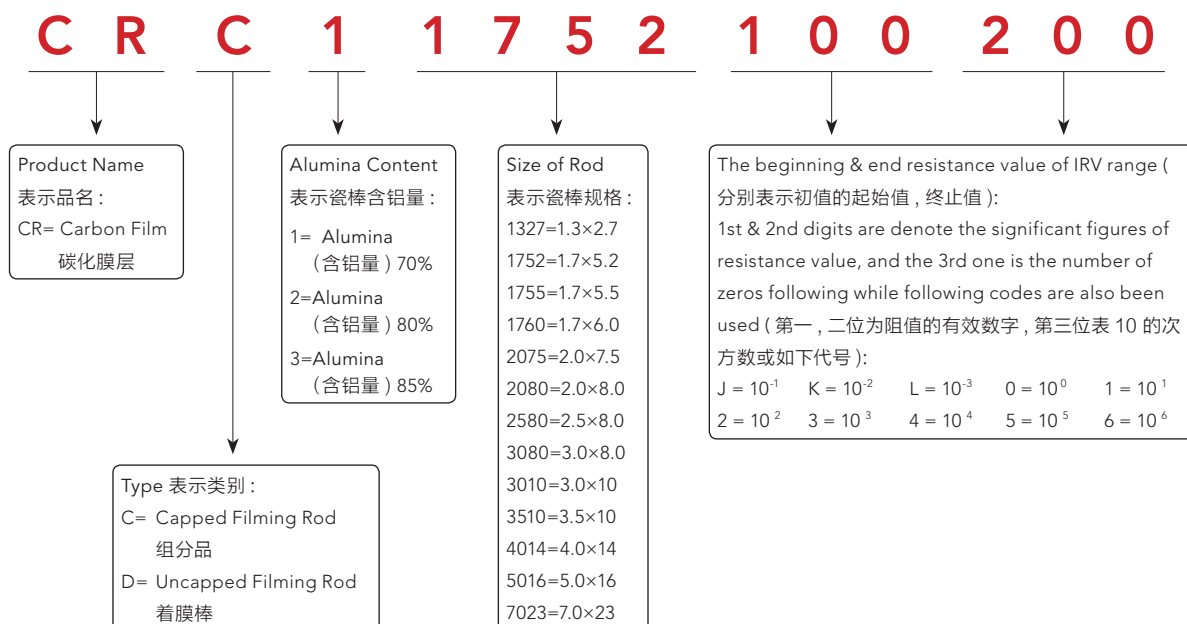



Feature (特性)

- Filming in PCD technology. (采用 PCD 成膜技术).
- Excellent Temperature coefficient, very low current noise. (温度系数范围低, 电流噪声小).
- Wide IRV range, suitable to produce high precision product. (初值范围宽, 适用于生产高精度产品)

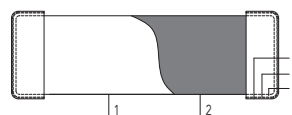

1. Ceramic (瓷棒)
2. Film (膜层)
3. Cap (iron) (铁帽, 铁)
4. Cap (copper) (铁帽, 铜层)
5. Cap (tin) (铁帽, 锡层)

Dimension (尺寸) (单位: mm)

| NO | Size 规格 | Uncapped Filming Rod 着膜棒 | | Capped Filming Rod 组成品 | | MIN PULLING FORCE 最小拉力 (KG) |
|----|---------|--|-------------------------------------|------------------------|-------------|--------------------------------|
| | | D 直径 | L 长度 | D 直径 | L 长度 | |
| 1 | 1.3x2.7 | 1.30±0.02 | 2.7±0.1 | 1.54~1.66 | 2.86~3.16 | 2 |
| 2 | 1.7x5.2 | 1.70±0.03 | 5.2 ^{+0.1} _{-0.2} | 2.03~2.17 | 5.36~5.76 | 3 |
| 3 | 1.7x5.5 | 1.70±0.03 | 5.5±0.2 | 2.03~2.17 | 5.66~6.16 | 3 |
| 4 | 1.7x6.0 | 1.70±0.03 | 6.0±0.2 | 2.03~2.17 | 6.16~6.66 | 3 |
| 5 | 2.0x7.5 | 2.00 ^{+0.04} _{-0.03} | 7.5±0.2 | 2.33~2.58 | 7.66~8.27 | 5 |
| 6 | 2.0x8.0 | 2.00±0.03 | 8.0±0.2 | 2.33~2.57 | 8.16~8.77 | 5 |
| 7 | 2.5x8.0 | 2.50±0.04 | 8.0±0.2 | 2.82~3.08 | 8.16~8.77 | 6 |
| 8 | 3.0x8.0 | 3.00±0.04 | 8.0±0.2 | 3.32~3.58 | 8.16~8.77 | 6 |
| 9 | 3.0x10 | 3.00±0.04 | 10.0±0.3 | 3.32~3.58 | 10.06~10.89 | 6 |
| 10 | 3.5x10 | 3.50 ^{+0.04} _{-0.05} | 10.0±0.3 | 3.81~4.08 | 10.06~10.89 | 6 |
| 11 | 4.0x14 | 4.00±0.05 | 14.0±0.3 | 4.31~4.59 | 14.06~14.89 | 6 |
| 12 | 5.0x16 | 5.00±0.05 | 16.0±0.3 | 5.41~5.59 | 16.16~16.89 | 6 |
| 13 | 7.0x23 | 7.00±0.07 | 23.0±0.5 | 7.39~7.61 | 22.96~24.09 | 6 |

IRV (Initial Resistance Value) Range (初值范围)

| | | | | | |
|-----------|---------|----------|-----------|-------------|-----------|
| 0.5Ω-0.8Ω | 4Ω-7Ω | 20Ω-30Ω | 100Ω-200Ω | 600Ω-900Ω | 4KΩ-7KΩ |
| 0.8Ω-1.3Ω | 5Ω-8Ω | 30Ω-50Ω | 150Ω-250Ω | 800Ω-1.3KΩ | 5KΩ-10KΩ |
| 1Ω-2Ω | 6Ω-10Ω | 40Ω-60Ω | 200Ω-400Ω | 1KΩ-2KΩ | 6KΩ-12KΩ |
| 1.5Ω-2.5Ω | 8Ω-13Ω | 50Ω-80Ω | 300Ω-500Ω | 1.5KΩ-2.5KΩ | 8KΩ-16KΩ |
| 2Ω-3.5Ω | 10Ω-20Ω | 60Ω-100Ω | 400Ω-600Ω | 2KΩ-4KΩ | 10KΩ-20KΩ |
| 3Ω-5Ω | 15Ω-25Ω | 80Ω-130Ω | 500Ω-800Ω | 3KΩ-5KΩ | |

Ordering Procedure (Example: MFC11752 101 201)

订购方式 (例如: MF 70% 1.7×5.2 100-200Ω)

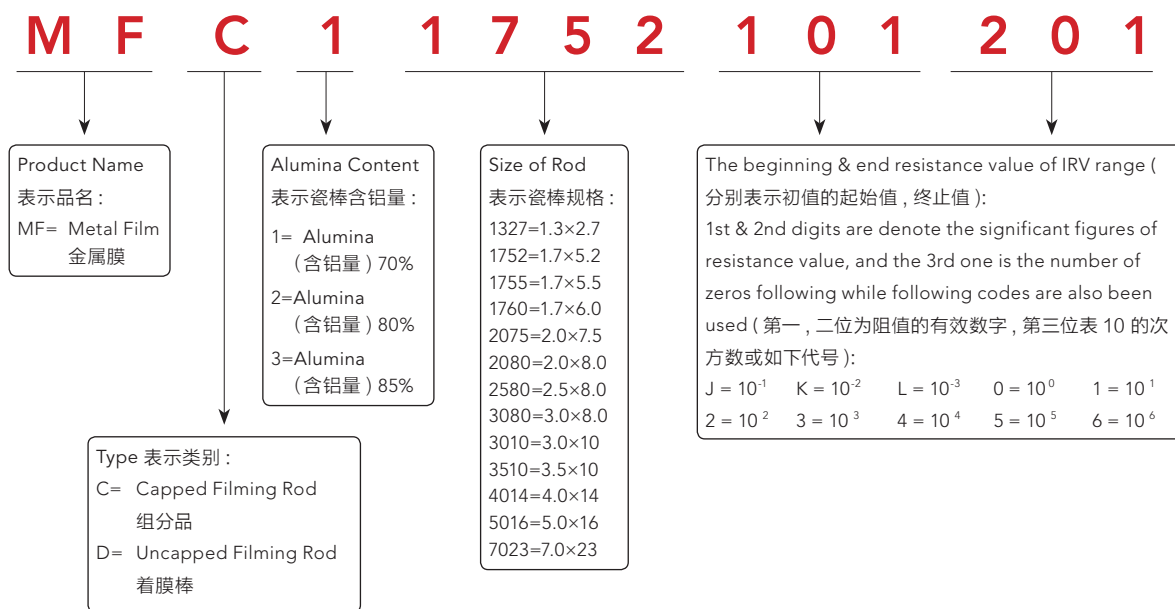



Feature (特性)

- Conductive Film Layer produced under High Temperature (高温烧成导电膜层)
- Good Performance under High Temperature environment (高温负荷能力强)
- First Choice for Power type resistor materials (功率型产品优选原料)

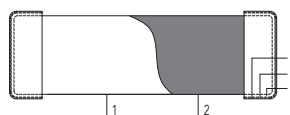

1. Ceramic (瓷棒)
2. Film (膜层)
3. Cap (iron) (铁帽, 铁)
4. Cap (copper) (铁帽, 铜层)
5. Cap (tin) (铁帽, 锡层)

Dimension (尺寸) (单位: mm)

| NO | Size 规格 | Uncapped Filming Rod 着膜棒 | | Capped Filming Rod 组成品 | | MIN PULLING FORCE 最小拉力 (KG) |
|----|---------|--|-------------------------------------|------------------------|-------------|--------------------------------|
| | | D 直径 | L 长度 | D 直径 | L 长度 | |
| 1 | 1.3×2.7 | 1.30±0.02 | 2.7±0.1 | 1.54~1.66 | 2.86~3.16 | 2 |
| 2 | 1.7×5.2 | 1.70±0.03 | 5.2 ^{+0.1} _{-0.2} | 2.03~2.17 | 5.36~5.76 | 3 |
| 3 | 1.7×5.5 | 1.70±0.03 | 5.5±0.2 | 2.03~2.17 | 5.66~6.16 | 3 |
| 4 | 1.7×6.0 | 1.70±0.03 | 6.0±0.2 | 2.03~2.17 | 6.16~6.66 | 3 |
| 5 | 2.0×7.5 | 2.00 ^{+0.04} _{-0.03} | 7.5±0.2 | 2.33~2.58 | 7.66~8.27 | 5 |
| 6 | 2.0×8.0 | 2.00±0.03 | 8.0±0.2 | 2.33~2.57 | 8.16~8.77 | 5 |
| 7 | 2.5×8.0 | 2.50±0.04 | 8.0±0.2 | 2.82~3.08 | 8.16~8.77 | 6 |
| 8 | 3.0×8.0 | 3.00±0.04 | 8.0±0.2 | 3.32~3.58 | 8.16~8.77 | 6 |
| 9 | 3.0×10 | 3.00±0.04 | 10.0±0.3 | 3.32~3.58 | 10.06~10.89 | 6 |
| 10 | 3.5×10 | 3.50 ^{+0.04} _{-0.05} | 10.0±0.3 | 3.81~4.08 | 10.06~10.89 | 6 |
| 11 | 4.0×14 | 4.00±0.05 | 14.0±0.3 | 4.31~4.59 | 14.06~14.89 | 6 |
| 12 | 5.0×16 | 5.00±0.05 | 16.0±0.3 | 5.41~5.59 | 16.16~16.89 | 6 |
| 13 | 7.0×23 | 7.00±0.07 | 23.0±0.5 | 7.39~7.61 | 22.96~24.09 | 6 |

IRV (Initial Resistance Value) Range (初值范围)

| | | | |
|---------|---------|-----------|-----------|
| 2Ω-3.5Ω | 8Ω-13Ω | 40Ω-60Ω | 150Ω-250Ω |
| 3Ω-5Ω | 10Ω-20Ω | 50Ω-80Ω | 200Ω-400Ω |
| 4Ω-7Ω | 15Ω-25Ω | 60Ω-100Ω | 300Ω-500Ω |
| 5Ω-8Ω | 20Ω-30Ω | 80Ω-130Ω | |
| 6Ω-10Ω | 30Ω-50Ω | 100Ω-200Ω | |

Ordering Procedure (Example: MOC11752101201)

订购方式 (例如: MO 70% 1.7×5.2 100-200Ω)

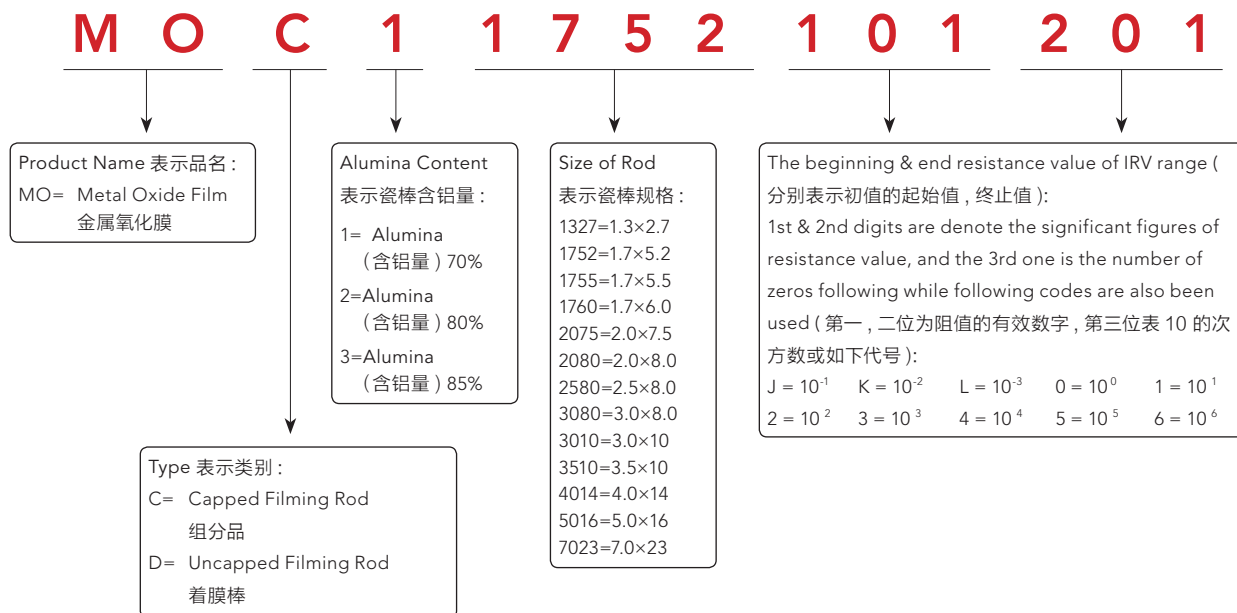



Feature (特性)

- Good performance against Humidity environment (耐湿特性好)
- Wide IRV range, can be sorted accurately (初值范围宽, 并可以精准分类)
- Best choice for Anti-surge product (抗浪涌型产品的优选原料)

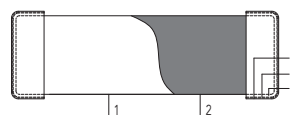

1. Ceramic (瓷棒)
2. Film (膜层)
3. Cap (iron) (铁帽, 铁)
4. Cap (copper) (铁帽, 铜层)
5. Cap (tin) (铁帽, 锡层)

Dimension (尺寸) (单位: mm)

| NO | Size 规格 | Uncapped Filming Rod 着膜棒 | | Capped Filming Rod 组成品 | | MIN PULLING FORCE 最小拉力 (KG) |
|----|---------|--|-------------------------------------|------------------------|-------------|--------------------------------|
| | | D 直径 | L 长度 | D 直径 | L 长度 | |
| 1 | 1.3×2.7 | 1.30±0.02 | 2.7±0.1 | 1.54~1.67 | 2.86~3.16 | 2 |
| 2 | 1.7×5.2 | 1.70±0.03 | 5.2 ^{+0.1} _{-0.2} | 2.03~2.18 | 5.36~5.76 | 3 |
| 3 | 1.7×5.5 | 1.70±0.03 | 5.5±0.2 | 2.03~2.18 | 5.66~6.16 | 3 |
| 4 | 1.7×6.0 | 1.70±0.03 | 6.0±0.2 | 2.03~2.18 | 6.16~6.66 | 3 |
| 5 | 2.0×7.5 | 2.00 ^{+0.04} _{-0.03} | 7.5±0.2 | 2.33~2.73 | 7.66~8.27 | 5 |
| 6 | 2.0×8.0 | 2.00±0.03 | 8.0±0.2 | 2.33~2.60 | 8.16~8.77 | 5 |
| 7 | 2.5×8.0 | 2.50±0.04 | 8.0±0.2 | 2.82~3.11 | 8.16~8.77 | 6 |
| 8 | 3.0×8.0 | 3.00±0.04 | 8.0±0.2 | 3.32~3.60 | 8.16~8.77 | 6 |
| 9 | 3.0×10 | 3.00±0.04 | 10.0±0.3 | 3.32~3.60 | 10.06~10.89 | 6 |
| 10 | 3.5×10 | 3.50 ^{+0.04} _{-0.05} | 10.0±0.3 | 3.81~4.10 | 10.06~10.89 | 6 |
| 11 | 4.0×14 | 4.00±0.05 | 14.0±0.3 | 4.31~4.67 | 14.06~14.89 | 6 |
| 12 | 5.0×16 | 5.00±0.05 | 16.0±0.3 | 5.41~5.62 | 16.16~16.89 | 6 |

IRV (Initial Resistance Value) Range (初值范围)

| | | | | |
|-----------|-------------|-----------|-------------|-------------|
| 15Ω-25Ω | 200Ω-400Ω | 3KΩ-5KΩ | 40KΩ-80KΩ | 500KΩ-800KΩ |
| 20Ω-30Ω | 300Ω-500Ω | 4KΩ-7KΩ | 50KΩ-100KΩ | 600KΩ-900KΩ |
| 30ΩE-50Ω | 400Ω-600Ω | 5KΩ-10KΩ | 60KΩ-120KΩ | 800KΩ-1.3MΩ |
| 40Ω-60Ω | 500Ω-800Ω | 6KΩ-12KΩ | 80KΩ-160KΩ | |
| 50Ω-80Ω | 600Ω-900Ω | 8KΩ-16KΩ | 100KΩ-200KΩ | |
| 60Ω-100Ω | 800Ω-1.3KΩ | 10KΩ-20KΩ | 150KΩ-300KΩ | |
| 80Ω-130Ω | 1KΩ-2KΩ | 15KΩ-30KΩ | 200KΩ-400KΩ | |
| 100Ω-200Ω | 1.5KΩ-2.5KΩ | 20KΩ-40KΩ | 300KΩ-500KΩ | |
| 150Ω-250Ω | 2KΩ-4KΩ | 30KΩ-60KΩ | 400KΩ-700KΩ | |

Ordering Procedure (Example: MGC32580104204)

订购方式 (例如: MG 85% 2.5×8.0 100-200KΩ)

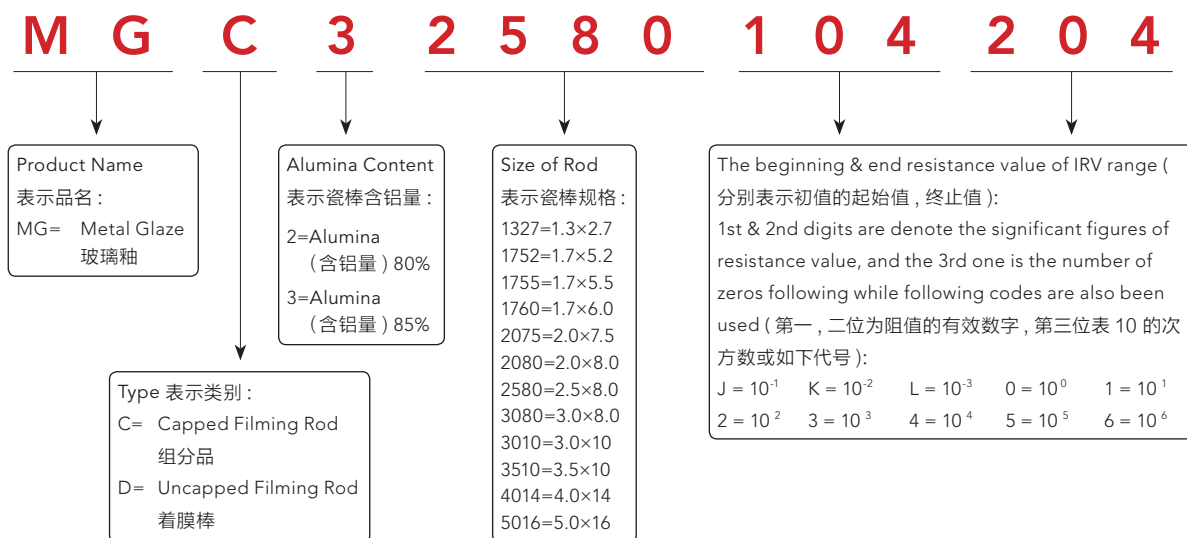



Feature (特性)

- Conductive layer (Ni) deposited by Chemical method (化学镀镍形成导电膜层)
- Extremely Low Resistance value (超低阻值)
- Specially used for Low Resistance range product (其他膜层低阻部分的替代品)

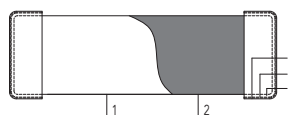

1. Ceramic (瓷棒)
2. Film (膜层)
3. Cap (iron) (铁帽, 铁)
4. Cap (copper) (铁帽, 铜层)
5. Cap (tin) (铁帽, 锡层)

Dimension (尺寸) (单位: mm)

| NO | Size 规格 | Uncapped Filming Rod 着膜棒 | | Capped Filming Rod 组成品 | | MIN PULLING FORCE 最小拉力 (KG) |
|----|---------|--------------------------|-------------------------------------|------------------------|-------------|--------------------------------|
| | | D 直径 | L 长度 | D 直径 | L 长度 | |
| 1 | 1.3×2.7 | 1.28~1.33 | 2.7±0.1 | 1.54~1.67 | 2.86~3.16 | 2 |
| 2 | 1.7×5.2 | 1.67~1.74 | 5.2 ^{+0.1} _{-0.2} | 2.03~2.18 | 5.36~5.76 | 3 |
| 3 | 1.7×5.5 | 1.67~1.74 | 5.5±0.2 | 2.03~2.18 | 5.66~6.16 | 3 |
| 4 | 1.7×6.0 | 1.67~1.74 | 6.0±0.2 | 2.03~2.18 | 6.16~6.66 | 3 |
| 5 | 2.0×7.5 | 1.97~2.19 | 7.5±0.2 | 2.33~2.73 | 7.66~8.27 | 5 |
| 6 | 2.0×8.0 | 1.97~2.06 | 8.0±0.2 | 2.33~2.60 | 8.16~8.77 | 5 |
| 7 | 2.5×8.0 | 2.46~2.57 | 8.0±0.2 | 2.82~3.11 | 8.16~8.77 | 6 |
| 8 | 3.0×8.0 | 2.96~3.06 | 8.0±0.2 | 3.32~3.60 | 8.16~8.77 | 6 |
| 9 | 3.0×10 | 2.96~3.06 | 10.0±0.3 | 3.32~3.60 | 10.06~10.89 | 6 |
| 10 | 3.5×10 | 3.45~3.56 | 10.0±0.3 | 3.81~4.10 | 10.06~10.89 | 6 |
| 11 | 4.0×14 | 3.95~4.13 | 14.0±0.3 | 4.31~4.67 | 14.06~14.89 | 6 |
| 12 | 5.0×16 | 4.95~5.08 | 16.0±0.3 | 5.41~5.62 | 16.16~16.89 | 6 |
| 13 | 7.0×23 | 6.93~7.10 | 23.0±0.5 | 7.39~7.64 | 22.96~24.09 | 6 |

IRV (Initial Resistance Value) Range (初值范围)

| | | |
|-------------|-------------|------------|
| 0.02Ω-0.03Ω | 0.10Ω-0.20Ω | 0.80Ω-1.3Ω |
| 0.03Ω-0.05Ω | 0.20Ω-0.30Ω | 1.0Ω-2.0Ω |
| 0.05Ω-0.07Ω | 0.30Ω-0.50Ω | |
| 0.07Ω-0.10Ω | 0.50Ω-0.80Ω | |

Ordering Procedure (Example: CNC1401480L13K)

订购方式 (例如: CN 70% 4.0×14 0.08-0.13Ω)

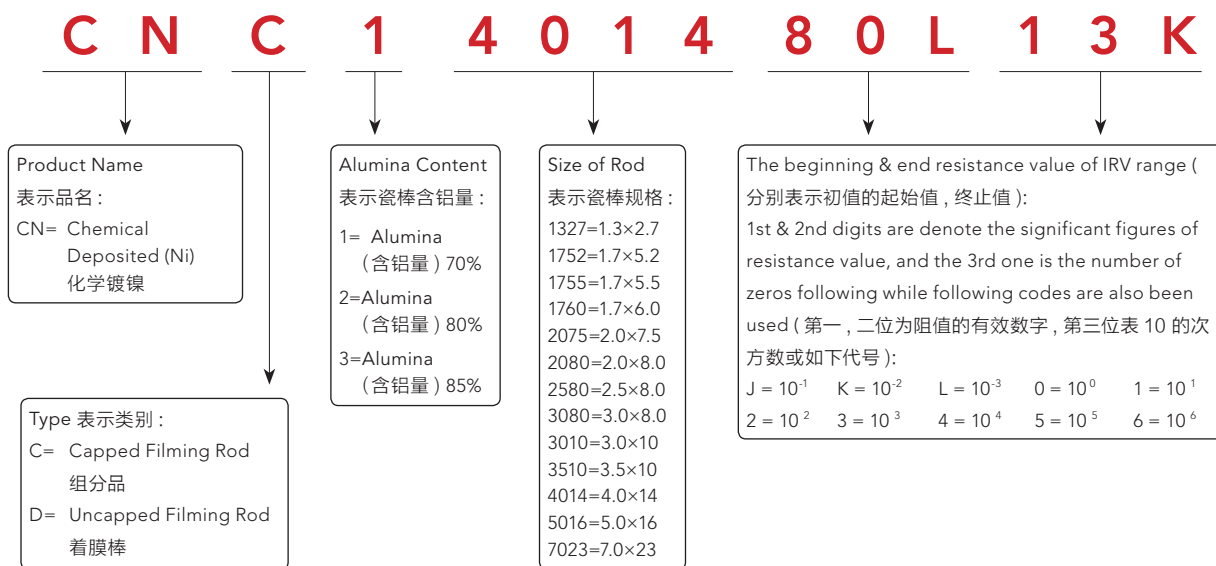



Feature (特性)

- Conductive layer formed by Copper Plating (or Tin plating) process (电镀铜层或锡层作为导电膜层)
- Resistance value can be lowest to mini ohm range (阻值可低至 mΩ)
- Ceramic rod core or Alloy rod core (陶瓷棒或合金棒作为基体材料)

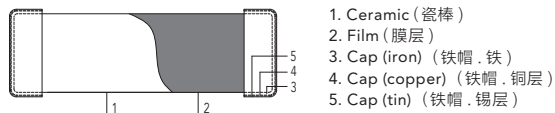

Copper Film Ceramic Rod 镀铜瓷棒 (单位: mm)

| NO | Size 规格 | Copper Film Ceramic Rod 镀铜瓷棒 | | Copper Film Capped Ceramic Rod 镀铜组帽棒 | |
|----|---------|------------------------------|-------------------------------------|--------------------------------------|-----------|
| | | D 直径 | L 长度 | D 直径 | L 长度 |
| 1 | 1.3x2.7 | 1.30±0.02 | 2.7±0.1 | 1.60~1.70 | 2.89~3.14 |
| 2 | 1.7x5.2 | 1.70±0.03 | 5.2 ^{+0.1} _{-0.2} | 2.09~2.21 | 5.39~5.74 |

Tinned Iron Rod (镀锡铁棒)

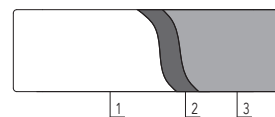

1.Fe 铁棒 2.Cu 铜层 3.Sn 锡层

Tinned Iron Rod (镀锡铁棒) (单位: mm)

| NO | Size 规格 | Tinned Iron Rod 镀锡铁棒 | |
|----|---------|----------------------|-------------|
| | | D 直径 | L 长度 |
| 1 | 1.3x2.7 | 1.50 ± 0.05 | 3.00 ± 0.05 |
| 2 | 1.7x5.2 | 2.00 ± 0.05 | 5.60 ± 0.05 |

IRV (Initial Resistance Value) Range (初值范围)

Standard resistance value ≤50mE, other value or special structure can be specially provided
标准品阻值 ≤50mΩ, 其他阻值或特殊结构的要求可以特别提供

Ordering Procedure (Example: ZOC11752000000)

订购方式 (例如: ZO 70% 1.7×5.2 0Ω)

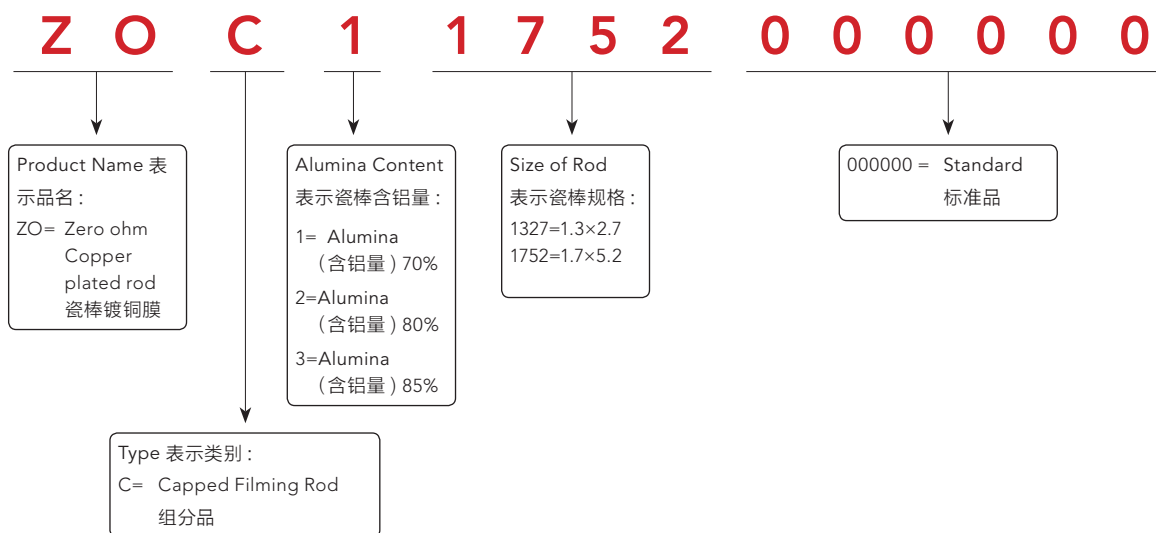

Ordering Procedure (Example: TOE01327000000)

订购方式 (例如 :0Ω 1.3×2.7 镀锡铁棒)

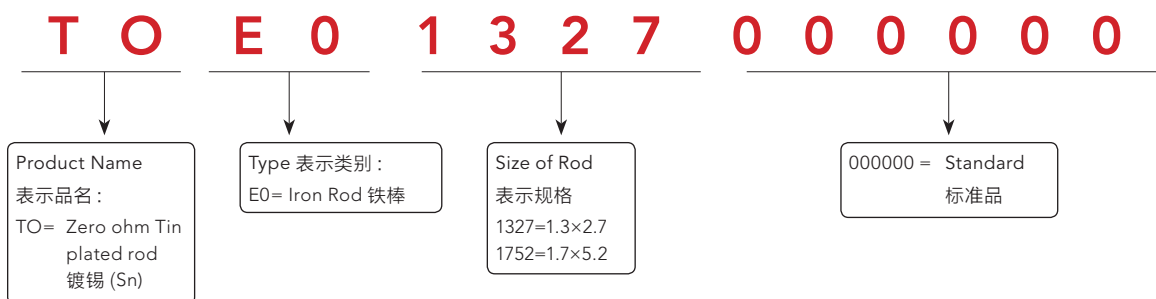



Feature (特性)

- Suitable for many different kinds of Electronic parts (适用各类电子产品)
- Full series in different size (规格齐全)
- Surface treatments in Tin & Copper Plating (表面经过镀铜镀锡处理)

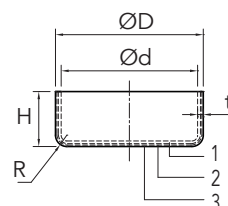

1. Fe 铁
2. Cu 铜层
3. Sn 锡层

Dimension (尺寸) (单位: mm)

| NO | Size 规格 | ØD 直径 | Ød 内径 | H 高度 | R(Max. 最大) | t±0.02 |
|----|-------------|-----------|------------|-----------|------------|--------|
| 1 | 1.26 × 0.95 | 1.62±0.02 | 1.265±0.02 | 0.95±0.02 | 0.15 | 0.15 |
| 2 | 1.64 × 1.42 | 2.10±0.02 | 1.64±0.02 | 1.42±0.04 | 0.20 | 0.20 |
| 3 | 1.95 × 1.74 | 2.51±0.02 | 1.93±0.02 | 1.74±0.03 | 0.25 | 0.25 |
| 4 | 1.95 × 1.85 | 2.51±0.02 | 1.93±0.02 | 1.85±0.03 | 0.25 | 0.25 |
| 5 | 2.45 × 1.95 | 3.00±0.02 | 2.44±0.02 | 1.95±0.05 | 0.25 | 0.25 |
| 6 | 2.90 × 2.00 | 3.50±0.03 | 2.92±0.02 | 2.00±0.05 | 0.25 | 0.25 |
| 7 | 2.90 × 2.10 | 3.50±0.03 | 2.92±0.02 | 2.10±0.05 | 0.25 | 0.25 |
| 8 | 3.41 × 2.35 | 4.00±0.03 | 3.41±0.02 | 2.35±0.05 | 0.25 | 0.25 |
| 9 | 3.91 × 2.35 | 4.50±0.03 | 3.91±0.03 | 2.35±0.05 | 0.25 | 0.25 |
| 10 | 4.90 × 2.85 | 5.48±0.02 | 4.88±0.03 | 2.85±0.05 | 0.25 | 0.25 |
| 11 | 6.90 × 3.45 | 7.50±0.02 | 6.90±0.03 | 3.45±0.05 | 0.25 | 0.25 |

Ordering Procedure (Example: TOCA12600000FS)

订购方式 (例如: 镀锡铁帽 Ø1.26)

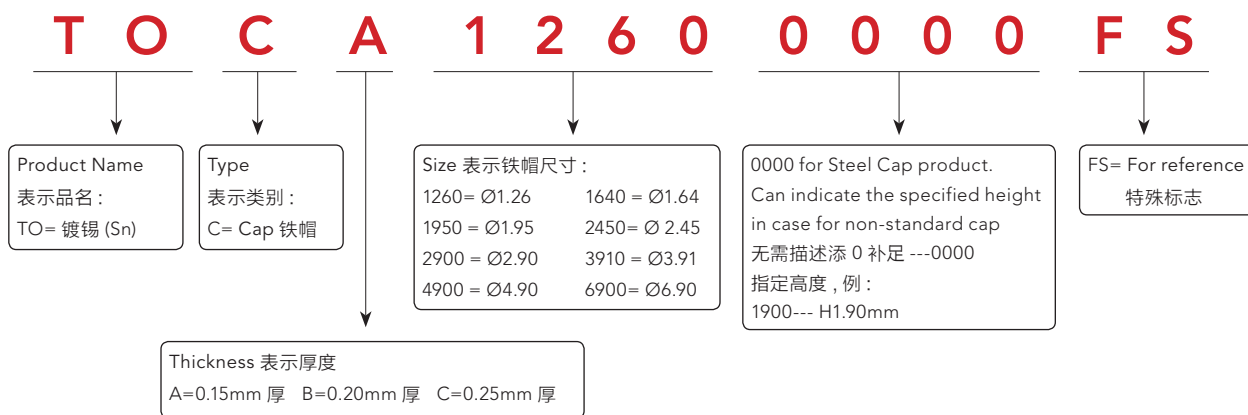

Remark: Special size can be provided according to customer's request
备注: 特殊尺寸可以按客户的要求订制



Feature (特性)

- Superior Talc Material (优质滑石瓷原料)
- Full series in different size (规格齐全)
- Hot-briquetting & Dry-pressing two different process (热压和干压两种成形方式)

Type & Dimension (类型及尺寸) (单位: mm)

| Type (类型) | 功率 | 2W | 3W | 5W | 7W | 10W | 15W | 20W | 25W | 30W | 40W |
|-----------|-----|---------|-----------|---------|------|------|------|------|------|-----|-----|
| | L 长 | 18 | 22 | 22 | 35 | 49 | 49 | 60 | 64 | - | - |
| | W 宽 | 7 | 8 | 10 | 10 | 10 | 12.5 | 14.5 | 14.5 | - | - |
| | H 高 | 7 | 8 | 9 | 9 | 9 | 11.5 | 13.5 | 13.5 | - | - |
| | L 长 | 20 | 25 | 25 | 38 | 50 | - | 45 | - | - | - |
| | W 宽 | 11.5 | 12.5 | 12.5 | 12.5 | 12.5 | - | 20 | - | - | - |
| | H 高 | 7.5 | 8.5 | 9 | 9 | 9 | - | 13.5 | - | - | - |
| | L 长 | - | 22 | 27/25 | 35 | 48 | 48 | 63 | - | - | - |
| | W 宽 | - | 10 | 10 | 10 | 10 | 12.5 | 12.5 | - | - | - |
| | H 高 | - | 9 | 9 | 9 | 9 | 11.5 | 13.5 | - | - | - |
| | L 长 | - | - | - | - | 48 | 48 | 63 | - | 75 | 90 |
| | W 宽 | - | - | - | - | 10 | 12.5 | 12.5 | - | 19 | 19 |
| | H 高 | - | - | - | - | 9 | 11.5 | 13.5 | - | 19 | 19 |
| | L 长 | 13 / 26 | 13 / 26 | 14 / 26 | 26 | 26 | - | - | - | - | - |
| | W 宽 | 5 | 5 | 5 | 5 | - | - | - | - | - | - |
| | H 高 | 8.5 / 9 | 13.5 / 13 | 18 | 20 | 18 | - | - | - | - | - |

Remark: Special type and dimension can be ordered by customer's request.
备注: 特殊尺寸可以按客户的要求订制

Performance Specifications (性能)

| Item | 项目 | Unit 单位 | Specification 标准 |
|---|------------------|-----------------------|--------------------|
| Bulk Density | 体积密度 | g/cm ³ | ≥ 2.8 |
| Flexural Strength | 抗折强度 | MPa | 139 |
| Coefficient of Linear Thermal Expansion | 线膨胀系数 (20~100°C) | ×10 ⁻⁶ /°C | 7.3 |
| Permittivity | 介电常数 (1MHz 20°C) | F/M | 6.2 |
| Dielectric Loss Tangent | 介质损耗角正切值 | ×10 ⁻⁴ | 13 |
| Volume Resistivity | 体积电阻率 (100°C) | Ω.cm | ≥ 10 ¹² |
| Dielectric Strength | 击穿强度 | Kv / mm | ≥ 20 |

Ordering Procedure (Example: CK0PRW0000500FS)

订购方式 (例如 :PRW5W 瓷壳)

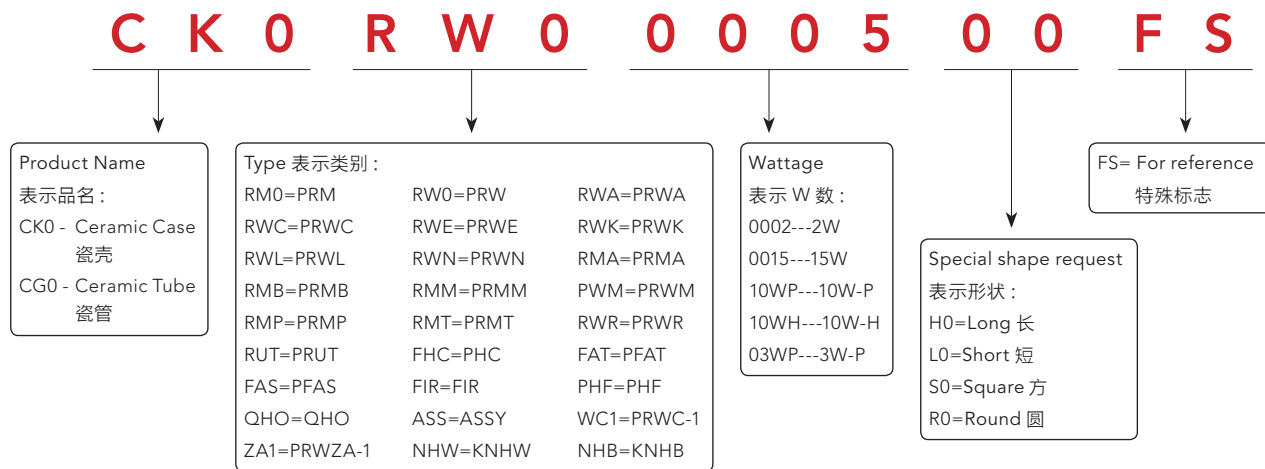

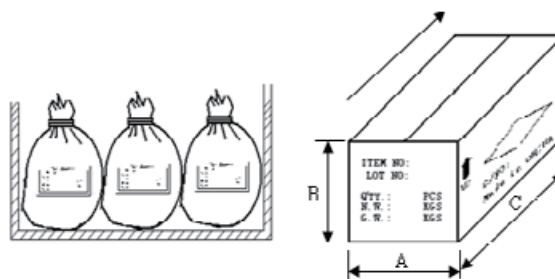

| Packing (标准包装方式) | | | | | | |
|--------------------------|-----------|----------------|----|----|----------------------|------|
| Type (类型) | | Size (尺寸) (mm) | | | Quantity (数量) (KPCS) | |
| Aluminum Content (瓷棒) | | | | | | |
| | | A | B | C | 袋 | 盒 |
| 1 | 1.3 × 2.7 | 25 | 20 | 45 | 600 | 1800 |
| 2 | 1.7 × 5.2 | 25 | 20 | 45 | 200 | 600 |
| 3 | 1.7 × 5.5 | 25 | 20 | 45 | 200 | 600 |
| 4 | 1.7 × 6.0 | 25 | 20 | 45 | 200 | 600 |
| 5 | 2.0 × 7.5 | 25 | 20 | 45 | 100 | 300 |
| 6 | 2.0 × 8.0 | 25 | 20 | 45 | 100 | 300 |
| 7 | 2.5 × 8.0 | 25 | 20 | 45 | 60 | 180 |
| 8 | 3.0 × 8.0 | 25 | 20 | 45 | 40 | 120 |
| 9 | 3.0 × 10 | 25 | 20 | 45 | 40 | 120 |
| 10 | 3.5 × 10 | 25 | 20 | 45 | 25 | 75 |
| 11 | 4.0 × 14 | 25 | 20 | 45 | 12.5 | 37.5 |
| 12 | 5.0 × 16 | 25 | 20 | 45 | 7.5 | 22.5 |
| 13 | 7.0 × 23 | 25 | 20 | 45 | 2.5 | 7.5 |
| Capped Ceramic Rod (组帽棒) | | | | | | |
| 1 | 1.3 × 2.7 | 25 | 20 | 45 | 600 | 1800 |
| 2 | 1.7 × 5.2 | 25 | 20 | 45 | 200 | 600 |
| 3 | 1.7 × 5.5 | 25 | 20 | 45 | 200 | 600 |
| 4 | 1.7 × 6.0 | 25 | 20 | 45 | 200 | 600 |
| 5 | 2.0 × 7.5 | 25 | 20 | 45 | 100 | 300 |
| 6 | 2.0 × 8.0 | 25 | 20 | 45 | 100 | 300 |
| 7 | 2.5 × 8.0 | 25 | 20 | 45 | 60 | 180 |
| 8 | 3.0 × 8.0 | 25 | 20 | 45 | 40 | 120 |
| 9 | 3.0 × 10 | 25 | 20 | 45 | 40 | 120 |
| 10 | 3.5 × 10 | 25 | 20 | 45 | 25 | 75 |
| 11 | 4.0 × 14 | 25 | 20 | 45 | 12.5 | 37.5 |
| 12 | 5.0 × 16 | 25 | 20 | 45 | 7.5 | 22.5 |
| 13 | 7.0 × 23 | 25 | 20 | 45 | 2.5 | 7.5 |

| Packing (标准包装方式) | | | | | | | |
|--|-------------|------------------|----|----|------------------------|------|--|
| Tpye (类型) | | Size (尺寸) (mm) | | | Quantity (数量) (KPCS) | | |
| Zero Ohm product (0Ω 产品) | | | | | | | |
| Copper plated 0 ohm in Ceramic core 镀铜瓷棒 | 1.3 × 2.7 | 25 | 20 | 45 | 600 | 1800 | |
| Tin plated 0 ohm in Ceramic core 镀铜瓷棒 | 1.7 × 5.2 | 25 | 20 | 45 | 200 | 600 | |
| Copper plated 0 ohm in Steel core 铁棒镀铜镀锡 | 1.3 × 2.7 | 25 | 20 | 45 | 300 | 900 | |
| Tin plated 0 ohm in Steel core 铁棒镀铜镀锡 | 1.7 × 5.2 | 25 | 20 | 45 | 100 | 300 | |
| Tin-Plated Steel Cap (铁帽) | | | | | | | |
| 1 | 1.26 × 0.95 | 25 | 20 | 45 | 1800 | 5400 | |
| 2 | 1.64 × 1.42 | 25 | 20 | 45 | 900 | 2700 | |
| 3 | 1.95 × 1.85 | 25 | 20 | 45 | 600 | 1800 | |
| 4 | 2.45 × 1.95 | 25 | 20 | 45 | 250 | 750 | |
| 5 | 2.90 × 2.10 | 25 | 20 | 45 | 200 | 600 | |
| 6 | 3.41 × 2.35 | 25 | 20 | 45 | 150 | 450 | |
| 7 | 3.91 × 2.35 | 25 | 20 | 45 | 120 | 360 | |
| 8 | 4.90 × 2.85 | 25 | 20 | 45 | 80 | 240 | |
| 9 | 6.90 × 3.45 | 25 | 20 | 45 | 40 | 120 | |

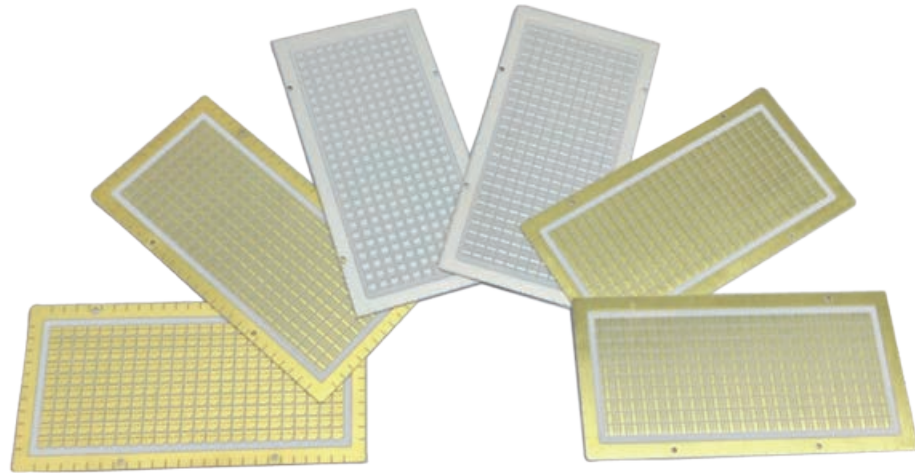

Technology Description (技术说明)

厚声采用半导体薄膜创新观念，开发直接电镀铜 (Direct Plating Copper, DPC) 陶瓷基板制程，完美的结合陶瓷散热及金属之特性。此制程利用溅镀及曝光显影方式在陶瓷基板上刻划出各种各样的电路图形，在经由电镀方式不仅可使金属与陶瓷两种不同属性之物质相互紧密结合，线路亦不易脱落 (结合力佳)。透过微显技术线路位置可更准确，线距更缩小之优点。主要应用于高亮度高功率 LED、微波无线通信、太阳能组件及半导体设备等领域。

Uni-Royal using the semiconductor thin-film innovative idea to develop the Direct Plating Copper (DPC) manufacturing process, in order to perform the excellent properties of metal and ceramic. This process developed by sputtering and exposure procedure to produce a wide variety of circuit pattern, by plating integrated the metal and ceramic properties, which the metallized metal will not be easy to peel off (good adhesion). Through this technology, the line position can be more accurately, and more narrow margin of line. Application mainly used in high brightness and high power LED, microwave radio Communication (Wireless) and semiconductor equipment, solar cell and other fields.

Thin Film Structures 薄膜结构

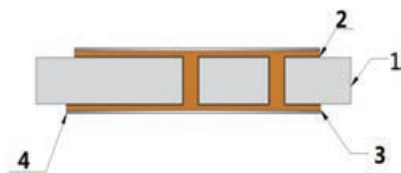

- ① Substrate 基板
- ② Sputter layer 溅镀层
- ③ Conductive layer 导电层
- ④ Surface Coating 表面金属层

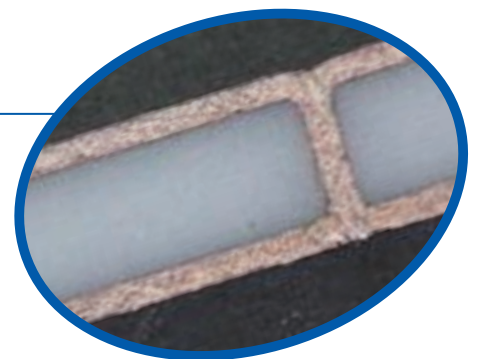

Thin Film Technology Feature (薄膜技术特征)

- ✓ 采用薄膜工艺制程获得精准的线路
- ✓ 优化的使用散热陶瓷材料特性
- ✓ 高热可靠性，能承受 300°C 1min 热板测试
- ✓ 良好的热结合力，可达拉力 1Kg 以上
- ✓ 优异的导通性能，阻抗 ≤0.1E
- ✓ 可按客户要求设计
- ✓ 高散热系数材料远优于 PCB 和 LTCC
- ✓ 高热稳定性远优于铝基板
- ✓ 符合 ROHS 要求
- ✓ Thin-film process to obtain accurate of line
- ✓ Optimize the best used of thermal properties of ceramic
- ✓ High reliability , withstand 300 °C within 1
- ✓ Good thermal adhesion, tensile reach > 1kg up
- ✓ Excellent conduction performance, impedance under controlled within 0.1E
- ✓ According to customer requirements, OEM available
- ✓ Highly dissipation coefficient than PCB and LTCC
- ✓ Highly heat stability superior than aluminum substrate
- ✓ ROHS compliant for global application

Process Capability 制程能力

| Item 项目 | Reference Range 参考范围 |
|----------------------------|--|
| Material 材质 | AL ₂ O ₃ 、ALN |
| Dimension & Thickness 尺寸厚度 | Sheet size 4.5"114.3x114.3mm 0.25、0.28、0.38、0.5、1.0mm |
| Set-PIN 上机孔 | Ø1、1.3、1.5、1.8、2mm Depending on the client machine 取决于客户机台 |
| VIA diameter 导通孔径 | 40~150µm Depending on the customer requirement 依客户需求 |
| Line spacing 线路间距 | The smallest diameter of up to 60µm 最小线径可达 60µm |
| Plate margins 板边距 | Sheet design set aside a minimum of 3mm 基板设计预留最小 3mm |
| Copper Thickness 镀层厚度 | Cu 30~75µm |
| Surface Coating 表面处理 | Electronless Gold/Silver 化学镀 (金 / 银)、Eletrolytic Gold/Silver 电镀 (金 / 银)、OSP Antioxidant treatment 抗氧化处理 |

Reliability Test (可靠性测试)

| NO | Item 项目 | Parameter 测试参数 | Specification 测试规范 |
|----|------------------------------------|--|--|
| 1 | Adhesion test 附着力试验 | 1. Temp: RT 温度 :RT 2. Tool: G9000-SY 工具 :G9000-SY 3. Time adhesive 30 seconds 持续粘合 30 秒 4. Angle:180° 角度 : 180° | <ul style="list-style-type: none"> • The extensor must be no separate 镀层没有被分离 |
| 2 | Thermal Test 热板试验 | 1. Temp:300°C 温度 : 300°C 2. Times:1min 时间 :1 分钟 | <ul style="list-style-type: none"> • No yellowing、blisters 未黄变、起泡现象 |
| 3 | 耐热持久性试验 Thermal durability test | 1. Temp:150°C 温度 : 150°C 2. Times:3 hours 时间 :3 小时 | <ul style="list-style-type: none"> • test before-and-after 试验前后 • 尺寸形变量 ≤1% • Size shape variables are 1% or less • 导通阻抗恒低于 5mE • Conduction resistance constant below 5 mE |

TYPE 1

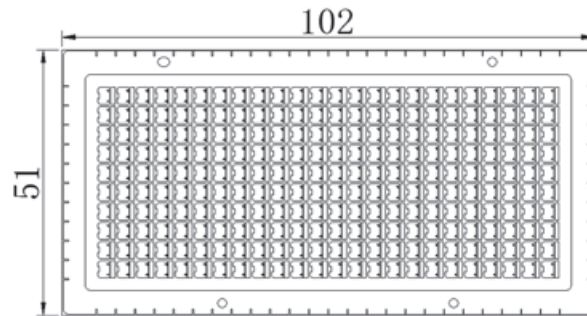
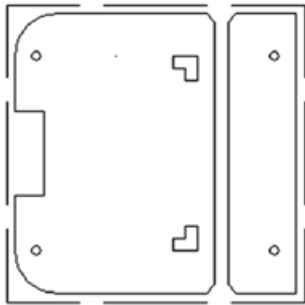

24 x 10 = 240 PCS

TYPE 2

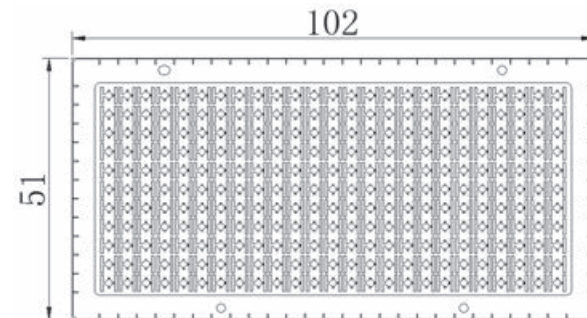
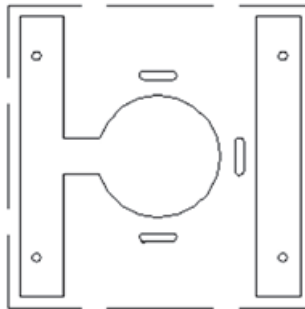

25 x 11 = 275 PCS

TYPE 3

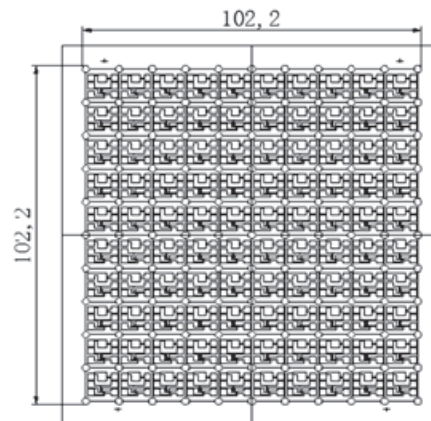
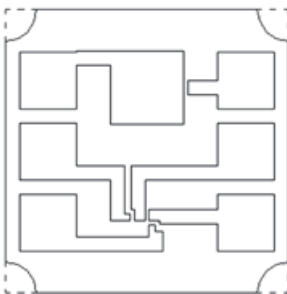

10 x 10 = 100 PCS

TYPE 4

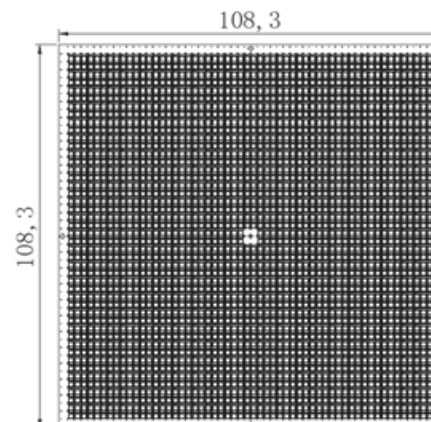
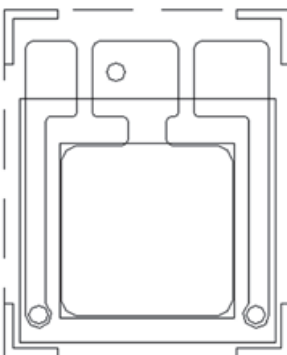

46 x 56 = 2576 PCS

Ceramic Processing Parts (陶瓷加工件)

- ✓ 优异的加工精度度
 - ✓ 高绝缘性能及机械性能强度
 - ✓ 客制化服务，可按客户要求进行处理
 - ✓ 精密研磨，表面粗化处理等
 - ✓ 适用于 LED 照明、汽车组件等产品加工
-
- ✓ Superior processing of accuracy
 - ✓ High performance of insulation and mechanical properties
 - ✓ Customized design services, OEM available
 - ✓ Precision grinding, coarsening treatment of surface
 - ✓ It's suitable for LED lighting, automotive components and other products processing

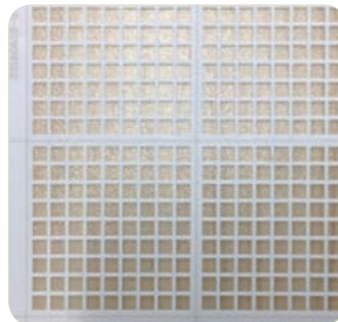
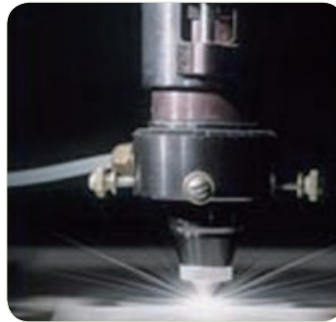

Thick-Film Features (厚膜特色)

运用丝网印刷技术，将金属浆料印刷在陶瓷基板上，经高温烧结而成。

By use the printing technology, the metal paste is printed on the ceramic substrate at high temperature sintering

我司可进行一系列薄厚 / 厚结合膜工艺的产品制作。

It can be a series of Bohou / thick film technology combined with products produced.

Thick Film Technology (厚膜技术特征)

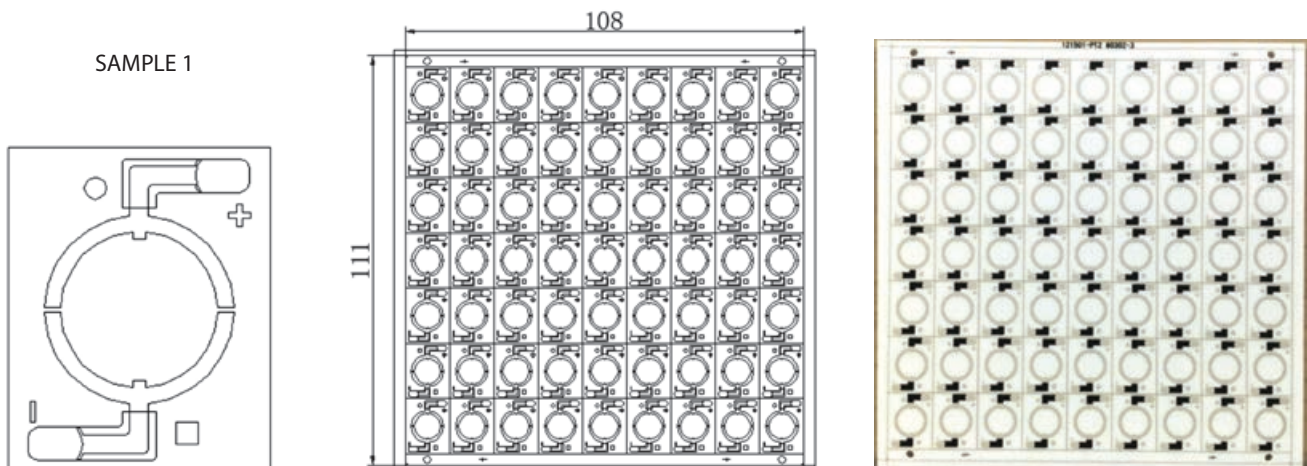

* PRODUCT DRAWING FOR REFERENCE ONLY 产品图片仅供参考

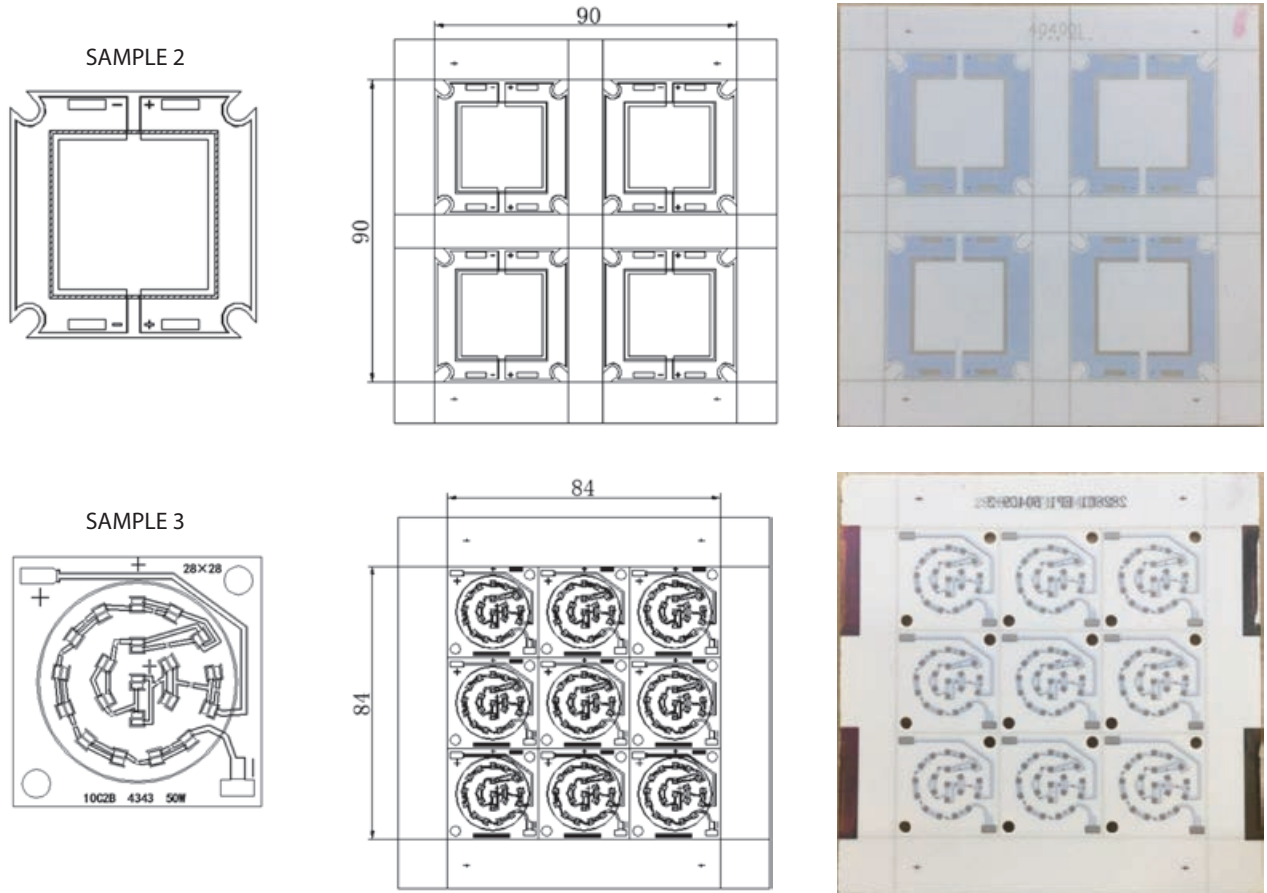

3 x 3 = 9 PCS

* PRODUCT DRAWING FOR REFERENCE ONLY 产品图片仅供参考

| 技术 | 线路精密度 | 表面平整度 | 加工工艺 | 成本 |
|------|--------|--------------|------|----|
| 厚膜技术 | >200um | 500- 1000 um | 简单 | 较低 |
| 薄膜技术 | >20um | < 300um | 复杂 | 较高 |

Storage conditions (储存条件)

- ✓ Store under 25±5°C,50±10% RH when sealed (密封保存)
- ✓ The expiration date is less than 3 months when unsealed (不开封产品保质期在 3 个月以内)
- ✓ Store under 25±5°C,50±10%RH when unsealed (开封产品的储存条件)
- ✓ Please store unsealed package in airtight containers and try to used within 3 days (已开封产品请于 3 日内使用完，并在一个密闭容器内开封)

Example: Open version of 3535 model type , Alumina sheet size 4.5”(114.3x114.3x0.5mm), via hole 75μm, Copper thickness 75μm, Gold (Au) thickness ≥0.03μm

例如: 公版 1 3535 规格 氧化铝基板尺寸 4.5 寸 (114.3x114.3x0.5mm), 孔径要求 75μm 铜厚要求 75μm 金 ≥0.03μm

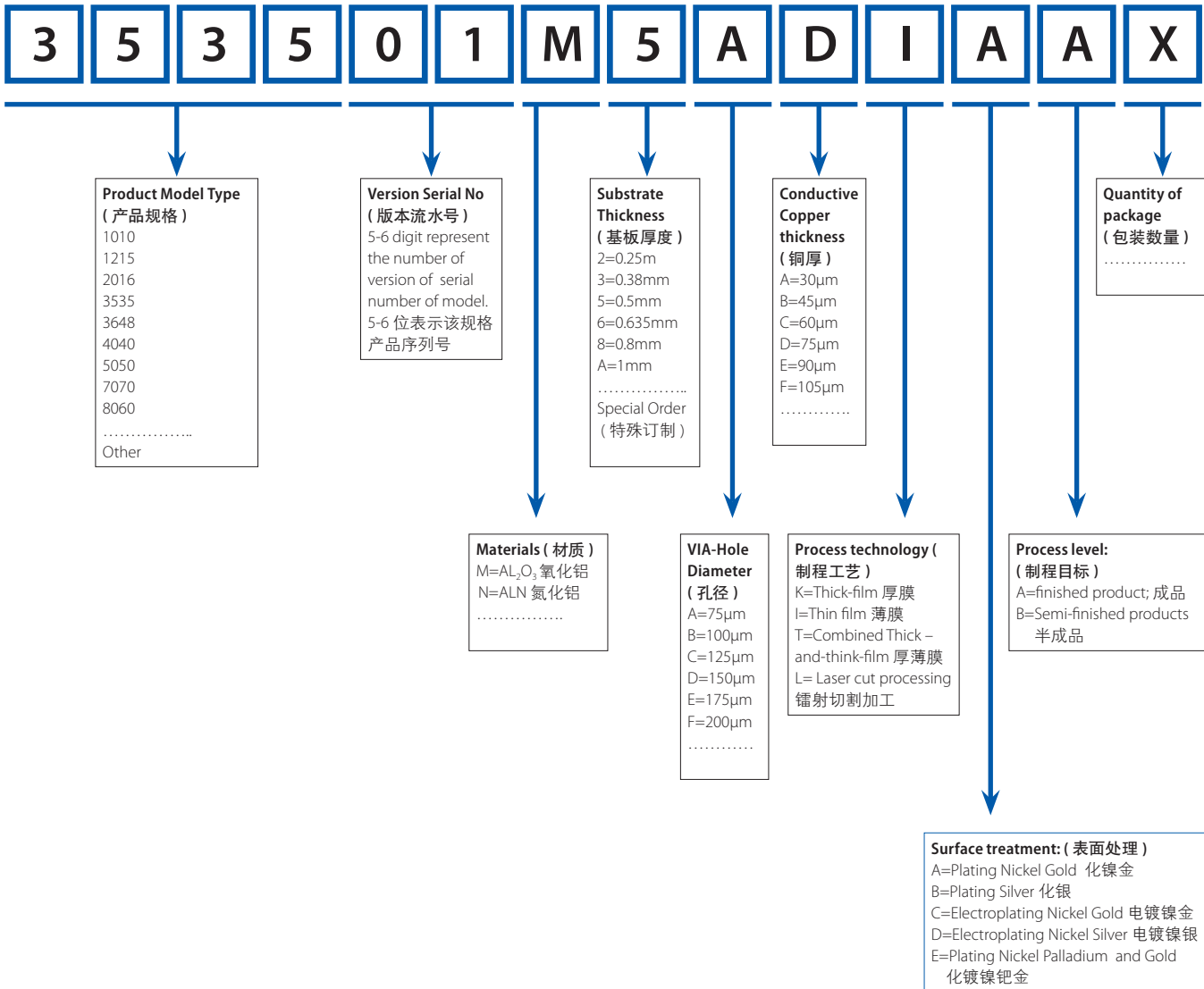

Uni-Royal

厚聲集團

- 台湾总部
新竹县湖口乡新竹工业园区
- 泰国生产基地
ROYAL ELECTRONIC FACTORY (THAILAND) CO., LTD
20/1-2 Moo 2, Klong Na, Muang, Chachoengsao 24000, Thailand
Tel: +66 3882 2404 ~ 2408
Email: info@royalohm.com
- 昆山生产基地 & 销售基地
昆山厚声电子工业有限公司
中国江苏省昆山市经济技术开发区龙腾路 88 号
Tel: +86 512 5763 1411 ~ 1433
Email: localsales@uniohm.com globalsales@uniohm.com
- 厦门生产基地 & 销售基地
厦门火炬高新区翔安（产业园区）赤埔路 301 号
Tel: +86 592 708 0691
Email : sales01@aeonohm.com
- 深圳销售基地
广东省深圳市宝安区西乡镇黄麻布第二工业区 & 九围工业区
Tel: +86 755 2997 5889 Email: sales-sz@uniohm.com
Tel: +86 755 6186 1798 Email: neil@royalohm.com.cn

- 总部
- 生产基地
- 销售基地

Resistors
电阻成品

Material
电子材料

Heat Dissipation Substrate
散热基板



FOSS



厚声集团 Uni-Royal

厚声国际贸易 (昆山) 有限公司
Uni-Royal International Trading (Kunshan) Co., Ltd.
中国江苏省昆山市经济技术开发区龙腾路88号
邮政编码: 215334
88th LongTeng Road, Economic & Technical Development
Zone, Kunshan, Jiangsu, China
Tel: +86 512 5763 1400 / 1411 /1422 /1433
Fax: +86 512 5763 4599
localsales@uniohm.com
globalsales@uniohm.com

厦门分公司 Xiamen Branch

中国厦门火炬高新区翔安 (产业园区) 赤埔路301号
邮政编码: 361101
301 Chi Pu Road, Xiamen Torch(Xiang An) Industrial Zone,
Xiamen, Fujian Province, China 361101
Tel: +86 592 7080561/516 Fax: 86 592 7167756
sales@aeonohm.com

深圳分公司 Shenzhen Branch

广东省深圳市西乡镇九围第一工业区厂房16号四楼
邮政编码: 518000
4th Floor, Block 16th, Jiuwei Industrial Zone, Xixiang Town
Bao'An District, Shenzhen City, Guangdong Province, China
Tel: +86 0755-27484508 Fax: +86 0755-27484308
info-sz@royalohm.com.cn



最新产品信息



scan to know new products

www.uni-royal.cn www.uniohm.com

X-ON Electronics

Largest Supplier of Electrical and Electronic Components

Click to view similar products for [Thin Film Resistors - SMD category](#):

Click to view products by [Uniroyal manufacturer](#):

Other Similar products are found below :

[7-2176089-6](#) [MCW0406MD1001DP500](#) [FCR1206J22R](#) [FCR1206J33R](#) [1-2176090-3](#) [1-2176089-6](#) [ERA-3EEB2742V](#)
[NCSR250F4M50DTRGF](#) [2176089-1](#) [2176090-4](#) [2176091-3](#) [CPA2512Q6R80FS-T10](#) [4-1625868-7](#) [5-1625868-9](#) [5-18022-5](#) [ERA-](#)
[3EEB2671V](#) [CFR0W4J0220A2P](#) [P1206Y1804FNNTA](#) [CPA2512E68R0FS-T10](#) [CPA2512Q4R70FS-T10](#) [8-2176091-9](#) [2-2176091-0](#)
[NCSR150FR003DTRT3F](#) [NTR06B5832CTRF](#) [NCSR200JR002DTRF](#) [RSJ372NL](#) [NRC-S12F4751TRF](#) [8-1625868-1](#) [1-2176092-4](#) [4-](#)
[2176093-9](#) [2176091-9](#) [RT1220P-101-M](#) [PLTU0805U1003LST5](#) [PLTU0603U2001LST5](#) [PLTU0805U1001LST5](#) [PLTU0603U4702LST5](#) [4-](#)
[2176089-0](#) [8-2176091-0](#) [6-2176091-8](#) [3-2176090-3](#) [1-2176092-7](#) [7-2176092-6](#) [7-2176088-7](#) [PCNM2512E1502BST5](#) [2-2176094-5](#)
[PCNM2512E3012BST5](#) [4-2176092-6](#) [3-2176091-4](#) [8-2176091-5](#) [7-2176089-5](#)