

**UNI-ROYAL**  
厚聲集團

# DATA SHEET

**Product Name** Wide Terminal Thick Film Chip Resistors

---

**Part Name** WR Series

## Uniroyal Electronics Global Co., Ltd.

88 Longteng Road, Economic & Technical Development Zone, Kunshan, Jiangsu, China

Tel +86 512 5763 1411 / 22 /33

Email [marketing@uni-royal.cn](mailto:marketing@uni-royal.cn)

Manufacture Plant Uniroyal Electronics Industry (kunshan) co., ltd.  
Uniroyal Electronics Industry Co., Ltd.  
Uniroyal Electronics Global Co.,Ltd Shenzhen Branch  
Aeon Technology Corporation  
Uniroyal Electronics Global Co.,Ltd Xiamen Branch  
Kunshan Foss Electronic material Co., Ltd.  
Royal Electronic Factory (thailand) co., ltd

Brands *RoyalOhm* *UniOhm*



## 1. Scope

- 1.1 This specification for approve relates to the Wide Terminal Thick Film Chip Resistors manufactured by UNI-ROYAL.
- 1.2 Suitable for both wave & re-flow soldering
- 1.3 Application: AV adapters, LCD back-light, camera strobe etc

## 2. Explanation of Part No. System

Part No. includes 14 codes shown as below:

2.1 1st~4th codes: Part name. E.g.: WR08, WR12, WR20, WR18, WR25

2.2 5th~6th codes: Power rating.

E.g.: W=Normal Size		“1~G” = “1~16”									
Wattage	1/32	3/4	1/2	1/3	1/4	1/8	1/10	1/16	1/20	1	
Normal Size	WH	07	W2	W3	W4	W8	WA	WG	WM	1W	

If power rating is lower or equal than 1 watt, 5<sup>th</sup> code would be “W” and 6<sup>th</sup> code would be a number or letter.

E.g.: WA=1/10W                      W4=1/4W

2.3 7<sup>th</sup> code: Tolerance. E.g.: D=±0.5%                      F=±1%                      G=±2%                      J=±5%                      K= ±10%

2.4 8<sup>th</sup>~11<sup>th</sup> codes: Resistance Value.

2.4.1 If value belongs to standard value of ≥5% series, 8<sup>th</sup> code would be zero, 9<sup>th</sup>~10<sup>th</sup> codes are significant figures of the resistance and 11<sup>th</sup> code is the power of ten.

2.4.2 If value belongs to standard value of ≤2% series, 8<sup>th</sup>~10<sup>th</sup> codes are significant figures of the resistance, and 11<sup>th</sup> code is the power of ten.

2.4.3 11<sup>th</sup> codes listed as following:

0=10<sup>0</sup>    1=10<sup>1</sup>    2=10<sup>2</sup>    3=10<sup>3</sup>    4=10<sup>4</sup>    5=10<sup>5</sup>    6=10<sup>6</sup>    J=10<sup>-1</sup>    K=10<sup>-2</sup>    L=10<sup>-3</sup>    M=10<sup>-4</sup>    N=10<sup>-5</sup>    P=10<sup>-6</sup>

2.5 12<sup>th</sup>~14<sup>th</sup> codes.

2.5.1 12<sup>th</sup> code: Packaging Type. E.g.: C=Bulk                      T=Tape/Reel

2.5.2 13<sup>th</sup> code: Standard Packing Quantity.

4=4000pcs    5=5000pcs    C=10000pcs    D=20000pcs    E=15000pcs

Chip Product: BD=B/B-20000pcs    TC=T/R-10000pcs

2.5.3 14<sup>th</sup> code: Special features.

E = Environmental Protection, Lead Free, or Standard type.

## 3. Ordering Procedure

(Example: WR18 1W ±5% 10KΩ T/R-4000)

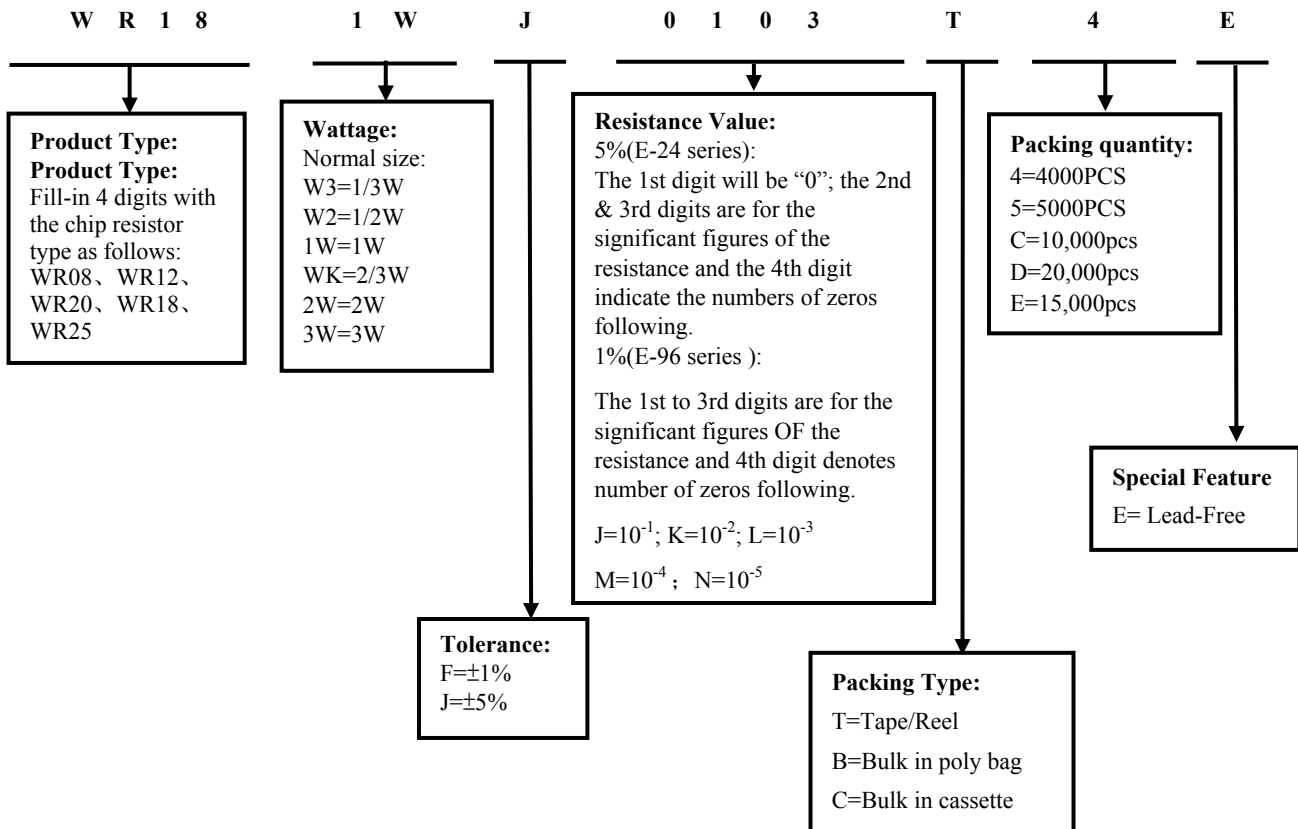

## 4. Marking

(1)  $\pm 5\%$  Tolerance: The first two digits are significant figures of resistance and the third denotes number of zeros following

Example:

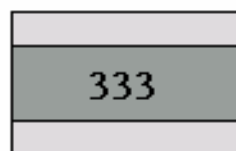

333  $\rightarrow$  33K $\Omega$

(2)  $\pm 5\%$  Tolerance: Below 10 $\Omega$  show as following, read alphabet "R" as decimal point.

Example:

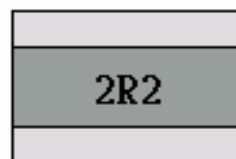

2R2  $\rightarrow$  2.2 $\Omega$

(3)  $\pm 1\%$  Tolerance: 4 digits, first three digits are significant; the fourth digit is number of zeros. Letter r is decimal point.

Example:

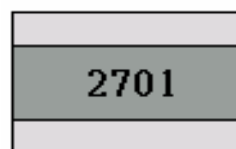

2701  $\rightarrow$  2.7K $\Omega$

(4)  $\pm 5\%$ ,  $\pm 1\%$  Tolerance, Product below 1 $\Omega$ , show as following, the first digit is "R" which as decimal point.

Example:

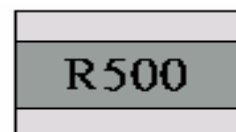

R500  $\rightarrow$  0.5 $\Omega$

## 5. Dimension

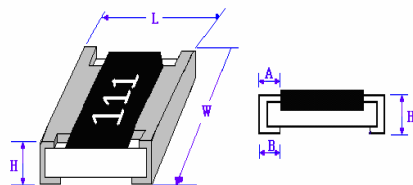

Type	Dimension(mm)				
	L	W	H	A	B
WR08(0508)	1.20 $\pm$ 0.10	2.0 $\pm$ 0.10	0.55 $\pm$ 0.10	0.20 $\pm$ 0.10	0.30 $\pm$ 0.20
WR12(0612)	1.60 $\pm$ 0.15	3.20 $\pm$ 0.15	0.55 $\pm$ 0.10	0.30 $\pm$ 0.20	0.45 $\pm$ 0.20
WR20(1020)	2.50 $\pm$ 0.15	5.00 $\pm$ 0.15	0.55 $\pm$ 0.10	0.40 $\pm$ 0.20	0.60 $\pm$ 0.20
WR18(1218)	3.10 $\pm$ 0.10	4.60 $\pm$ 0.15	0.55 $\pm$ 0.10	0.45 $\pm$ 0.20	0.40 $\pm$ 0.20
WR25(1225)	3.10 $\pm$ 0.15	6.25 $\pm$ 0.15	0.55 $\pm$ 0.10	0.45 $\pm$ 0.20	0.65 $\pm$ 0.20

## 6. Resistance Range

Type	Power Rating at 70 $^{\circ}$ C	Resistance Range	
		$\pm 1\%$	$\pm 5\%$
WR08	1/3W	10 $\Omega$ ~1M	
	2/3W	10m $\Omega$ $\leq$ R<10 $\Omega$	
WR12	1/2W	10 $\Omega$ ~1M	1 $\Omega$ <R $\leq$ 1M
	1W	10m $\Omega$ $\leq$ R $\leq$ 10 $\Omega$	
WR20	1W	10 $\Omega$ ~1M	1 $\Omega$ ~1M
		10m $\Omega$ ~1 $\Omega$	
WR18	1W	10m $\Omega$ ~1M $\Omega$	
WR25	2W	1 $\Omega$ <R $\leq$ 1M	
	3W	10m $\Omega$ $\leq$ R $\leq$ 1 $\Omega$	

## 7. Ratings

Type	Max Working Voltage	Max Overload Voltage	Dielectric Withstanding Voltage	Resistance Value of Jumper	Rated Current of Jumper	Max. Overload Current of Jumper	Operating Temperature
WR08	150V	300V	500V	< 50mΩ	4A	8A	-55°C~155°C
WR12	200V	400V	500V	< 50mΩ	5A	10A	-55°C~155°C
WR20	200V	400V	500V	< 50mΩ	6A	12A	-55°C~155°C
WR18	200V	400V	500V	< 50mΩ	6A	10A	-55°C~155°C
WR25	200V	400V	500V	< 50mΩ	6A	15A	-55°C~155°C

## 8. Recommend the size of welding plate

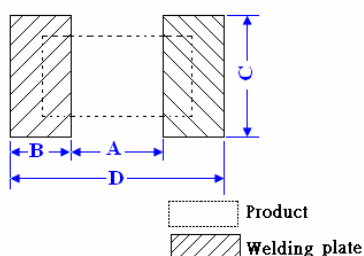

Type	Dimension(mm)			
	A	B	C	D
WR08	0.5±0.1	1.0±0.1	2.0±0.1	2.7±0.1
WR12	0.6±0.1	1.0±0.1	3.2±0.1	2.9±0.1
WR20	1.1±0.1	1.2±0.1	5.0±0.1	3.5±0.1
WR18	2.2±0.1	1.2±0.1	4.6±0.1	4.6±0.1
WR25	1.4±0.1	1.3±0.1	6.4±0.1	4.0±0.1

## 9. Derating Curve

Resistors shall have a power rating based on continuous load operation at an ambient temperature from -55°C to 70°C. For temperature in excess of 70°C, the load shall be derated as shown in figure 1

Figure 1

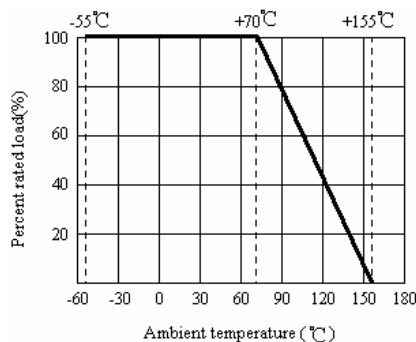

Voltage rating:

Resistors shall have a rated direct-current (DC) continuous working

voltage or an approximate sine-wave root-mean-square (RMS) alternating-current (AC) continuous working voltage at commercial-line frequency and waveform corresponding to the power rating, as determined from the following formula:

$$RCWV = \sqrt{P \times R}$$

Where: RCWV commercial-line frequency and waveform (Volt.)

P = power rating (WATT.) R = nominal resistance (OHM)

In no case shall the rated DC or RMS AC continuous working voltage be greater than the applicable maximum value.

The overload voltage is 2.5 times RCWV or Max. Overload voltage whichever is less

## 10. Structure

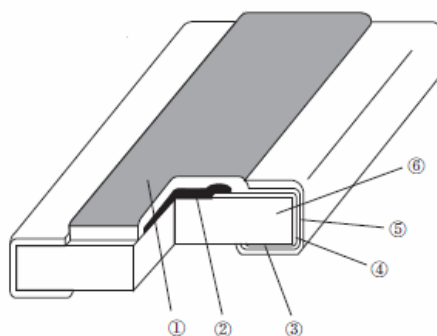

1. Protective layer
2. Resistive element
3. Termination (Inner) Ni / Cr
4. Termination (Between) Ni
5. Termination (Outer) Sn
6. High purity Alumina substrate

## 11. Performance Specification

Characteristic	Limits	Test Methods (GB/T5729&JIS-C-5201&IEC60115-1)
Temperature Coefficient	<b>WR08:</b> $10\text{m}\Omega \leq R < 30\text{m}\Omega: 0 \sim +400 \text{ PPM}/^\circ\text{C}$ $30\text{m}\Omega \leq R < 10\Omega: 0 \sim +150 \text{ PPM}/^\circ\text{C}$ $10\Omega: \pm 400 \text{ PPM}/^\circ\text{C}$ $10\Omega < R \leq 100\Omega: \pm 200 \text{ PPM}/^\circ\text{C}$ $> 100\Omega: \pm 100 \text{ PPM}/^\circ\text{C}$	4.8 Natural resistance changes per temp. Degree centigrade $\frac{R_2 - R_1}{R_1(t_2 - t_1)} \times 10^6 \text{ (PPM}/^\circ\text{C)}$ R <sub>1</sub> : Resistance Value at room temperature (t <sub>1</sub> ) ; R <sub>2</sub> : Resistance at test temperature (Upper limit temperature or Lower limit temperature) t <sub>1</sub> : +25°C or specified room temperature t <sub>2</sub> : Upper limit temperature or Lower limit temperature test temperature
	<b>WR12:</b> $10\text{m}\Omega \leq R < 100\text{m}\Omega: 0 \sim +200 \text{ PPM}/^\circ\text{C}$ $100\text{m}\Omega \leq R \leq 10\Omega: 0 \sim +150 \text{ PPM}/^\circ\text{C}$ $1\Omega < R \leq 10\Omega: \pm 400 \text{ PPM}/^\circ\text{C}$ $10\Omega < R \leq 100\Omega: \pm 200 \text{ PPM}/^\circ\text{C}$ $> 100\Omega: \pm 100 \text{ PPM}/^\circ\text{C}$	
	<b>WR20:</b> $10\text{m}\Omega \leq R < 30\text{m}\Omega: 0 \sim +200 \text{ PPM}/^\circ\text{C}$ $30\text{m}\Omega \leq R \leq 1\Omega: 0 \sim +100 \text{ PPM}/^\circ\text{C}$ $1\Omega < R \leq 10\Omega: \pm 400 \text{ PPM}/^\circ\text{C}$ $10\Omega < R \leq 100\Omega: \pm 200 \text{ PPM}/^\circ\text{C}$ $> 100\Omega: \pm 100 \text{ PPM}/^\circ\text{C}$	
	<b>WR18:</b> $10\text{m}\Omega \leq R < 30\text{m}\Omega: 0 \sim +200 \text{ PPM}/^\circ\text{C}$ $30\text{m}\Omega \leq R \leq 1\Omega: 0 \sim +100 \text{ PPM}/^\circ\text{C}$ $1\Omega < R \leq 10\Omega: \pm 400 \text{ PPM}/^\circ\text{C}$ $10\Omega < R \leq 100\Omega: \pm 200 \text{ PPM}/^\circ\text{C}$ $> 100\Omega: \pm 100 \text{ PPM}/^\circ\text{C}$	
	<b>WR25:</b> $10\text{m}\Omega \leq R < 30\text{m}\Omega: 0 \sim +150 \text{ PPM}/^\circ\text{C}$ $30\text{m}\Omega \leq R \leq 1\Omega: 0 \sim +100 \text{ PPM}/^\circ\text{C}$ $1\Omega < R \leq 10\Omega: \pm 400 \text{ PPM}/^\circ\text{C}$ $10\Omega < R \leq 100\Omega: \pm 200 \text{ PPM}/^\circ\text{C}$ $> 100\Omega: \pm 100 \text{ PPM}/^\circ\text{C}$	
Short-time overload	±1%     ±(1.0%+0.005Ω)	4.13 Permanent resistance change after the application of 2.5 times RCWV for 5 seconds.
	±5%     ±(2.0%+0.005Ω)	
Soldering heat	±(1.0%+0.005Ω)	4.18 Dip the resistor into a solder bath having a temperature of 260°C±5°C and hold it for 10±1 seconds.

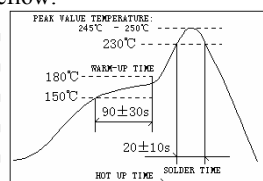
Dielectric withstanding voltage	No evidence of flashover mechanical damage, arcing or insulation breaks down.		4.7 Resistors shall be clamped in the trough of a 90°C metallic v-block and shall be tested at ac potential respectively specified in the given list of each product type for 60-70 seconds.
Solderability	Coverage must be over 95%.		Wave solder: Test temperature of solder: 245°C±3°C dipping time in solder: 2-3 seconds.
	Go up tin rate bigger than half of end pole		Reflow: 
Rapid change of temperature	±1%	±(0.5%+0.005Ω)	4.19 30 min at lower limit temperature and 30 min at upper limit temperature , 100 cycles.
	±5%	±(1.0%+0.005Ω)	
Terminal bending	±(1%+0.005Ω)		4.33 Twist of test board: Y/X = 3/90 mm for 60Seconds
Humidity ( steady state )	±1%	±(1.0%+0.005Ω)	4.24 Temporary resistance change after 240 hours exposure in a humidity test chamber controlled at 40±2°C and 90-95% relative humidity,
	±5%	±(3.0%+0.005Ω)	
Load life in humidity	±1%	±(1.0%+0.005Ω)	7.9 Resistance change after 1,000 hours (1.5 hours “ON”, 0.5 hour “OFF”) at RCWV in a humidity chamber controlled at 40 °C±2°C and 90 to 95% relative humidity.
	±5%	±(3.0%+0.005Ω)	
Load life	±1%	±(1.0%+0.005Ω)	4.25.1 Permanent resistance change after 1,000 hours operating at RCWV with duty cycle 1.5 hours “ON”, 0.5 hour “OFF” at 70 °C±2°C ambient.
	±5%	±(3.0%+0.005Ω)	
Low Temperature Storage	±1%	±(1.0%+0.005Ω)	4.23.4 Lower limit temperature , for 2H.
	±5%	±(3.0%+0.005Ω)	
High Temperature Exposure	±1%	±(1.0%+0.005Ω)	4.23.2 Upper limit temperature , for 16H.
	±5%	±(3.0%+0.005Ω)	
Leaching	No visible damage		J-STD-002 Test D Samples completely immersed for 30 sec in solder bath at 260°C

## 12. Packing of Surface Mount Resistors

12.1 Dimension of Paper Taping :(Unit: mm)

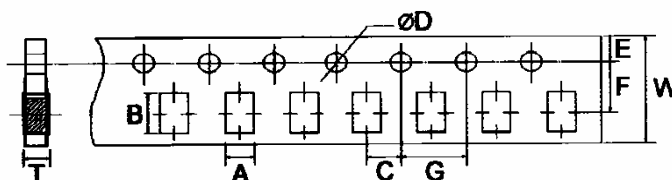

TYPE	A ±0.2	B ±0.2	C ±0.05	+0.1 ΦD -0	E ±0.1	F ±0.05	G ±0.1	W ±0.2	T ±0.1
WR08	1.65	2.40	2.0	1.5	1.75	3.5	4.0	8.0	0.81
WR12	2.00	3.60	2.0	1.5	1.75	3.5	4.0	8.0	0.81

## 12.2 Dimension of Embossed Taping: (Unit: mm)

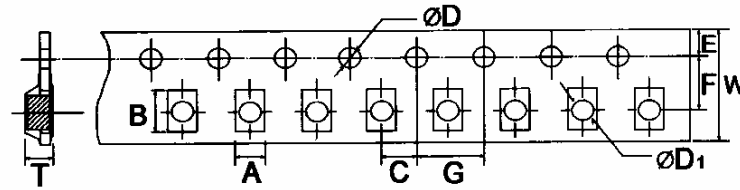

TYPE	A ±0.2	B ±0.2	C ±0.05	+0.1 φD -0	+0.25 φD1 -0	E ±0.1	F ±0.05	G ±0.1	W ±0.2	T ±0.1
WR20	2.9	5.6	2.0	1.5	1.5	1.75	5.5	4.0	12	1.0
WR18	3.5	4.8	2.0	1.5	1.5	1.75	5.5	4.0	12	1.0
WR25	3.5	6.7	2.0	1.5	1.5	1.75	5.5	4.0	12	1.0

## 12.3 Dimension of Reel : (Unit: mm)

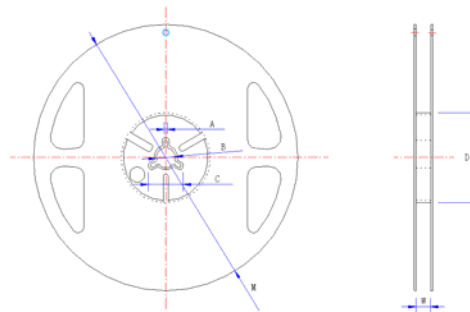

Type	Taping	Qty/Reel	A±0.5	B±0.5	C±0.5	D±1	M±2	W±1
WR08	Paper	5,000pcsl	2.0	13.0	21.0	60.0	178	10
WR12	Paper	5,000pcs	2.0	13.0	21.0	60.0	178	10
WR20	Embossed	4,000pcs	2.0	13.0	21.0	60.0	178	13.8
WR18	Embossed	4,000pcs	2.0	13.0	21.0	60.0	178	13.8
WR25	Embossed	4,000pcs	2.0	13.0	21.0	60.0	178	13.8

## 13. Note

13.1. UNI-ROYAL recommend the storage condition temperature: 15°C~35°C, humidity :25%~75%.

(Put condition for individual product).Even under UNI-ROYAL recommended storage condition, solderability of products over 1 year old. (Put condition for each product) may be degraded.

13.2. Store / transport cartons in the correct direction, which is indicated on a carton as a symbol.

Otherwise bent leads may occur due to excessive stress applied when dropping of a carton.

13.3. Product performance and soldered connections may deteriorate if the products are stored in the following places:

- Storage in high Electrostatic.
- Storage in direct sunshine、rain and snow or condensation.
- Where the products are exposed to sea winds or corrosive gases, including Cl<sub>2</sub>, H<sub>2</sub>S<sub>3</sub>, NH<sub>3</sub>, SO<sub>2</sub>, NO<sub>2</sub>.

## 14. Record

Version	Description of amendment	Page	Date	Amended by	Checked by
1	First issue of this specification	1~7	Mar.20, 2018	Chen Haiyan	Chen Nana
2	Modify performance criteria	5~6	May.02, 2018	Chen Haiyan	Chen Nana
3	1.Modify the resistance range of WR12 2.Modify the Performance Specification	3 5~6	Feb.13, 2019	Chen Haiyan	Xu Yuhua

Uniroyal Electronics Global Co., Ltd. , all rights reserved. Spec. herein would be changed at any time without prior notice.

## X-ON Electronics

Largest Supplier of Electrical and Electronic Components

*Click to view similar products for [Thick Film Resistors](#) category:*

*Click to view products by [Uniroyal](#) manufacturer:*

Other Similar products are found below :

[MCR03EZPFX3162](#) [MCR004YZPJ332](#) [201007J022KT4E](#) [201007F1653T4E](#) [201007F6652T4E](#) [0603WAF137KT5E](#) [RTT204702FTE](#)  
[RTT203000FTE](#) [RTT2056R0FTE](#) [CR2010F470KE04Z](#) [RTT018451FTH](#) [RTT021802DTH](#) [0402WGF510LTCE](#) [0201WMJ0200TEE](#)  
[TR0603B26K7P0550Z](#) [0201WMF5102TEE](#) [1210W2J047KT5E](#) [YLR12-2-4F-W](#) [HOT\(0.25x1.3\)-3.2-0R-I](#) [HOT\(0.4x1.5\)-5.2-0R-I](#)  
[HoT\(0.45x1.5\)-8.2-0R-I](#) [0201WMF1103TEE](#) [0201WMF7152TEE](#) [1210W2J0124T5E](#) [201007J010LT4E](#) [201007J0360T4E](#) [201007J0430T4E](#)  
[0805W8F931KT5E](#) [1206W4F5231T5E](#) [1210W2J0620T5E](#) [201007J0822T4E](#) [0201WMF1005TCE](#) [0201WMF1212TCE](#) [0201WMF1373TCE](#)  
[0201WMF1400TCE](#) [0201WMF2000TEE](#) [0201WMF2001TCE](#) [0201WMF226JTCE](#) [0201WMF2672TCE](#) [0201WMF2803TCE](#)  
[0201WMF357JTCE](#) [0201WMF3743TCE](#) [0201WMF430JTCE](#) [0201WMF4990TCE](#) [0201WMF5104TCE](#) [0201WMF510JTEE](#)  
[0201WMF5110TCE](#) [0201WMF6652TEE](#) [0201WMF6812TCE](#) [0201WMF8200TCE](#)