



UNI-ROYAL
厚聲集團

DATA SHEET

Product Name Wide Terminal Thick Film Chip Resistors

Part Name WR Series

Uniroyal Electronics Global Co., Ltd.

88#, Longteng Road, Economic & Technical Development Zone, Kunshan, Jiangsu, China

Tel +86 512 5763 1411 / 22 /33

Email marketing@uni-royal.cn

Manufacture Plant Uniroyal Electronics Industry Co., Ltd.

Aeon Technology Corporation

Royal Electronic Factory (Thailand) Co., Ltd.

Royal Technology (Thailand) Co., Ltd.

1. Scope

- 1.1 This datasheet is the characteristics of Wide Terminal Thick Film Chip Resistors manufactured by UNI-ROYAL.
 1.2 Suitable for both wave & re-flow soldering
 1.3 Application: AV adapters, LCD back-light, camera strobe etc

2. Part No. System

Part No. includes 14 codes shown as below:

2.1 1st~4th codes: Part name. E.g.: WR08, WR12, WR20, WR18, WR25

2.2 5th~6th codes: Power rating.

E.g.: W=Normal Size		“1~G” = “1~16”								
Wattage	1/32	3/4	1/2	1/3	1/4	1/8	1/10	1/16	1/20	1
Normal Size	WH	07	W2	W3	W4	W8	WA	WG	WM	1W

If power rating is equal or lower than 1 watt, 5th code would be “W” and 6th code would be a number or letter.

E.g.: WA=1/10W W4=1/4W

2.3 7th code: Tolerance. E.g.: D=±0.5% F=±1% G=±2% J=±5% K= ±10%

2.4 8th~11th codes: Resistance Value.

2.4.1 If value belongs to standard value of E-24 series, the 8th code is zero, 9th~10th codes are the significant figures of resistance value, and the 11th code is the power of ten.

2.4.2 If value belongs to standard value of E-96 series, the 8th~10th codes are the significant figures of resistance value, and the 11th code is the power of ten.

2.4.3 11th codes listed as following:

0=10⁰ 1=10¹ 2=10² 3=10³ 4=10⁴ 5=10⁵ 6=10⁶ J=10⁻¹ K=10⁻² L=10⁻³ M=10⁻⁴

2.5 12th~14th codes.

2.5.1 12th code: Packaging Type. E.g.: C=Bulk T=Tape/Reel

2.5.2 13th code: Standard Packing Quantity.

4=4,000pcs 5=5,000pcs C=10,000pcs D=20,000pcs E=15,000pcs

Chip Product: BD=B/B-20000pcs TC=T/R-10000pcs

2.5.3 14th code: Special features.

E = Environmental Protection, Lead Free, or Standard type.

3. Ordering Procedure

(Example: WR18 1W ±5% 10KΩ T/R-4000)

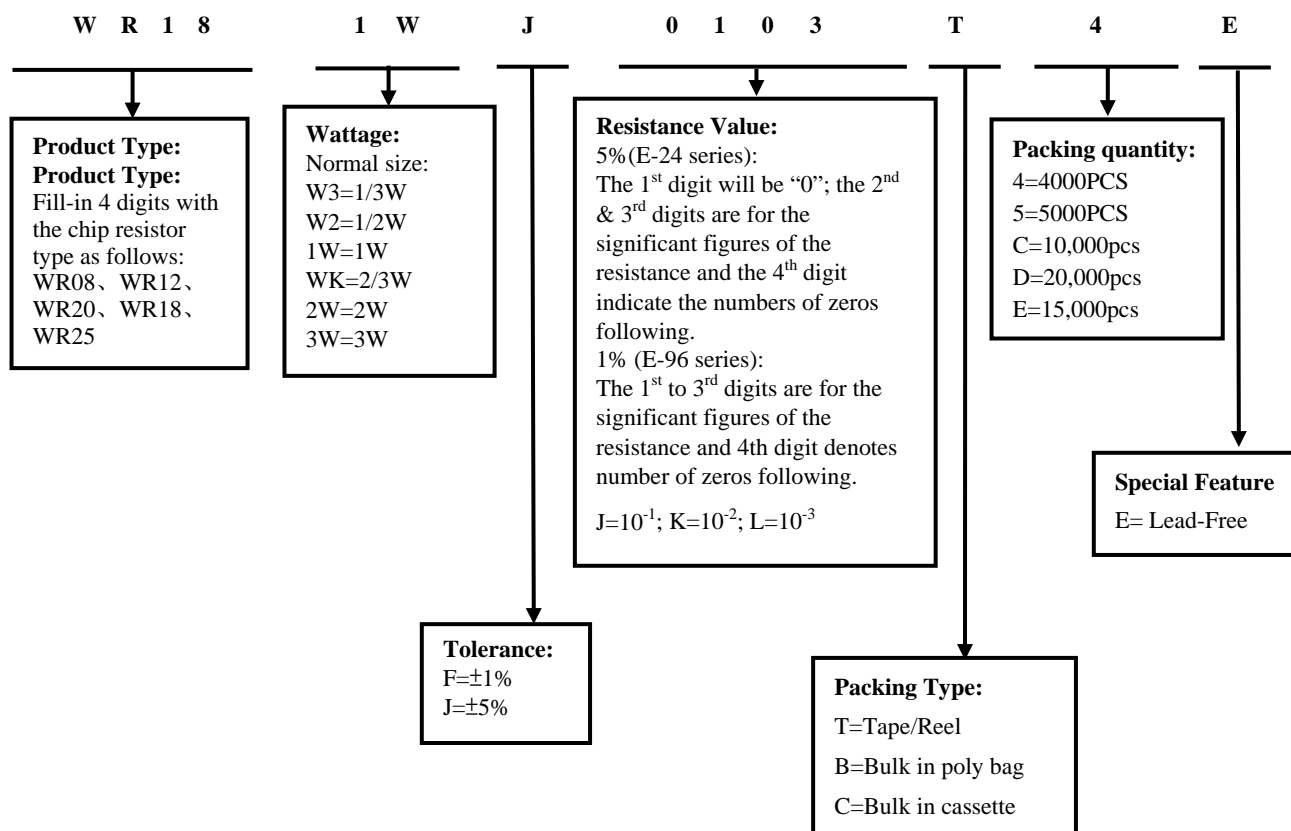

4. Marking

4.1 $\pm 5\%$ tolerance products (E-24 series):

3 codes.

1st~2nd codes are the significant figures of resistance value, and the rest code is the power of ten.

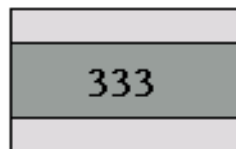

333 → 33K Ω

4.2 $\pm 5\%$ Tolerance: Below 10 Ω show as following, read alphabet "R" as decimal point.

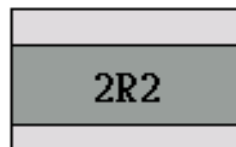

2R2 → 2.2 Ω

4.3 $\pm 1\%$ tolerance products (E-96 series):

4 codes.

1st~3rd codes are the significant figures of resistance value, and the rest code is the power of ten.

Letter "R" in mark means decimal point.

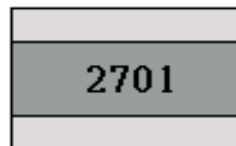

2701 → 2.7K Ω

4.4 $\pm 5\%$, $\pm 1\%$ Tolerance, Product below 1 Ω , show as following, the first digit is "R" which as decimal point.

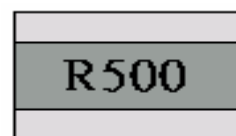

R500 → 0.5 Ω

5. Dimension

Type	Dimension(mm)				
	L	W	H	A	B
WR08(0508)	1.20 \pm 0.10	2.0 \pm 0.10	0.55 \pm 0.10	0.20 \pm 0.10	0.30 \pm 0.20
WR12(0612)	1.60 \pm 0.15	3.20 \pm 0.15	0.55 \pm 0.10	0.30 \pm 0.20	0.45 \pm 0.20
WR20(1020)	2.50 \pm 0.15	5.00 \pm 0.15	0.55 \pm 0.10	0.40 \pm 0.20	0.60 \pm 0.20
WR18(1218)	3.10 \pm 0.10	4.60 \pm 0.15	0.55 \pm 0.10	0.45 \pm 0.20	0.40 \pm 0.20
WR25(1225)	3.10 \pm 0.15	6.25 \pm 0.15	0.55 \pm 0.10	0.45 \pm 0.20	0.65 \pm 0.20

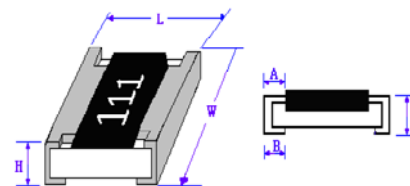

6. Resistance Range

Type	Power Rating at 70 $^{\circ}$ C	Resistance Range	
		$\pm 1\%$	$\pm 5\%$
WR08	1/3W	10 Ω ~1M	
	2/3W	10m~10 Ω	
WR12	1/2W	10 Ω <R \leq 1M	
	1W	10m Ω \leq R \leq 10 Ω	
WR20	1W	10 Ω ~1M	1 Ω ~1M
		10m Ω ~1 Ω	
WR18	1W	10m Ω ~1M Ω	
WR25	2W	1 Ω <R \leq 1M	
	3W	10m Ω \leq R \leq 1 Ω	

7. Ratings

Type	Max Working Voltage	Max Overload Voltage	Dielectric Withstanding Voltage	Resistance Value of Jumper	Rated Current of Jumper	Max. Overload Current of Jumper	Operating Temperature
WR08	150V	300V	500V	< 50mΩ	4A	8A	-55°C~155°C
WR12	200V	400V	500V	< 50mΩ	5A	10A	-55°C~155°C
WR20	200V	400V	500V	< 50mΩ	6A	12A	-55°C~155°C
WR18	200V	400V	500V	< 50mΩ	6A	10A	-55°C~155°C
WR25	200V	400V	500V	< 50mΩ	6A	15A	-55°C~155°C

8. Soldering pad size recommended

Type	Dimension(mm)			
	A	B	C	D
WR08	0.5±0.1	1.0±0.1	2.0±0.1	2.7±0.1
WR12	0.6±0.1	1.0±0.1	3.2±0.1	2.9±0.1
WR20	1.1±0.1	1.2±0.1	5.0±0.1	3.5±0.1
WR18	2.2±0.1	1.2±0.1	4.6±0.1	4.6±0.1
WR25	1.4±0.1	1.3±0.1	6.4±0.1	4.0±0.1

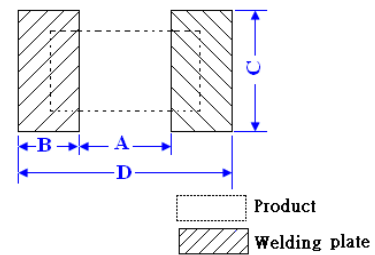

9. Derating Curve

Power rating will change based on continuous load at ambient temperature from -55 to 155°C. It is constant between -55 to 70°C, and derate to zero when temperature rise from 70 to 155°C.

Voltage rating:

Resistors shall have a rated direct-current (DC) continuous working voltage or an approximate sine-wave root-mean-square (RMS) alternating-current (AC) continuous working voltage at commercial-line frequency and waveform corresponding to the power rating, as determined from the following formula:

$$RCWV = \sqrt{P \times R}$$

Remark: RCWV: Rating Continuous Working Voltage (Volt.) P: power rating (Watt) R: nominal resistance (Ω)

In no case, the rated DC or RMS AC continuous working voltage must be greater than the applicable maximum value.

The overload voltage is 2.5 times RCWV or Max. Overload voltage whichever is lower.

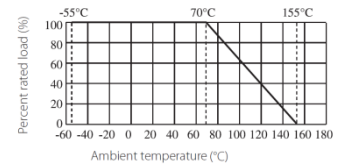

10. Structure

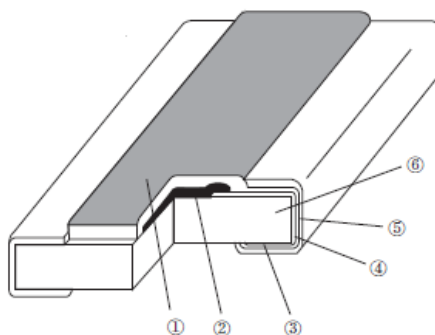

1. Protective layer
2. Resistive element
3. Termination (Inner) Ni / Cr
4. Termination (Between) Ni
5. Termination (Outer) Sn
6. High purity Alumina substrate

11. Performance Specification

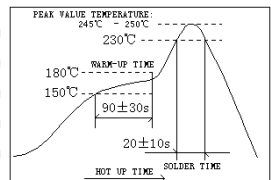
Characteristic	Limits	Test Methods (GB/T5729&JIS-C-5201&IEC60115-1)				
Temperature Coefficient	<p>WR08: $10\text{m}\Omega \leq R < 30\text{m}\Omega$: 0~+400 PPM/°C $30\text{m}\Omega \leq R < 10\Omega$: 0~+150 PPM/°C 10Ω: ±400 PPM/°C $10\Omega < R \leq 100\Omega$: ±200 PPM/°C $>100\Omega$: ±100 PPM/°C</p> <p>WR12: $10\text{m}\Omega \leq R < 100\text{m}\Omega$: 0~+200 PPM/°C $100\text{m}\Omega \leq R \leq 10\Omega$: 0~+150 PPM/°C $10\Omega < R \leq 100\Omega$: ±200 PPM/°C $>100\Omega$: ±100 PPM/°C</p> <p>WR20: $10\text{m}\Omega \leq R < 30\text{m}\Omega$: 0~+200 PPM/°C $30\text{m}\Omega \leq R \leq 1\Omega$: 0~+100 PPM/°C $1\Omega < R \leq 10\Omega$: ±400 PPM/°C $10\Omega < R \leq 100\Omega$: ±200 PPM/°C $>100\Omega$: ±100 PPM/°C</p> <p>WR18: $10\text{m}\Omega \leq R < 30\text{m}\Omega$: 0~+200 PPM/°C $30\text{m}\Omega \leq R \leq 1\Omega$: 0~+100 PPM/°C $1\Omega < R \leq 10\Omega$: ±400 PPM/°C $10\Omega < R \leq 100\Omega$: ±200 PPM/°C $>100\Omega$: ±100 PPM/°C</p> <p>WR25: $10\text{m}\Omega \leq R < 30\text{m}\Omega$: 0~+150 PPM/°C $30\text{m}\Omega \leq R \leq 1\Omega$: 0~+100 PPM/°C $1\Omega < R \leq 10\Omega$: ±400 PPM/°C $10\Omega < R \leq 100\Omega$: ±200 PPM/°C $>100\Omega$: ±100 PPM/°C</p>	<p>4.8 Natural resistance changes per temp. Degree centigrade</p> $\frac{R_2 - R_1}{R_1(t_2 - t_1)} \times 10^6 \text{ (PPM/°C)}$ <p>R_1: Resistance Value at room temperature (t_1) ; R_2: Resistance at test temperature (Upper limit temperature or Lower limit temperature) t_1: +25°C or specified room temperature t_2: Upper limit temperature or Lower limit temperature test temperature</p>				
Short-time overload	<table border="1"> <tr> <td>±1%</td> <td>±(1.0%+0.005Ω)</td> </tr> <tr> <td>±5%</td> <td>±(2.0%+0.005Ω)</td> </tr> </table>	±1%	±(1.0%+0.005Ω)	±5%	±(2.0%+0.005Ω)	4.13 Permanent resistance change after the application of 2.5 times RCWV for 5 seconds.
±1%	±(1.0%+0.005Ω)					
±5%	±(2.0%+0.005Ω)					
Soldering heat	±(1.0%+0.005Ω)	4.18 Dip the resistor into a solder bath having a temperature of 260°C±5°C and hold it for 10±1 seconds.				
Dielectric withstanding voltage	No evidence of flashover mechanical damage, arcing or insulation breaks down.	4.7 Resistors shall be clamped in the trough of a 90°C metallic v-block and shall be tested at ac potential respectively specified in the given list of each product type for 60-70 seconds.				
Solderability	Coverage must be over 95%.	Wave solder: Test temperature of solder: 245°C±3°C dipping time in solder: 2-3 seconds.				
	Go up tin rate bigger than half of end pole	Reflow: 				

Rapid change of temperature	$\pm 1\%$	$\pm(0.5\%+0.005\Omega)$	4.19 30 min at lower limit temperature and 30 min at upper limit temperature , 100 cycles.
	$\pm 5\%$	$\pm(1.0\%+0.005\Omega)$	
Terminal bending	$\pm(1\%+0.005\Omega)$		4.33 Twist of test board: Y/X = 3/90 mm for 60Seconds
Humidity (steady state)	$\pm 1\%$	$\pm(1.0\%+0.005\Omega)$	4.24 Temporary resistance change after 240 hours exposure in a humidity test chamber controlled at $40\pm 2^\circ\text{C}$ and 90-95% relative humidity,
	$\pm 5\%$	$\pm(3.0\%+0.005\Omega)$	
Load life in humidity	$\pm 1\%$	$\pm(1.0\%+0.005\Omega)$	7.9 Resistance change after 1,000 hours (1.5 hours “ON”, 0.5 hour “OFF”) at RCWV in a humidity chamber controlled at $40^\circ\text{C}\pm 2^\circ\text{C}$ and 90 to 95% relative humidity.
	$\pm 5\%$	$\pm(3.0\%+0.005\Omega)$	
Load life	$\pm 1\%$	$\pm(1.0\%+0.005\Omega)$	4.25.1 Permanent resistance change after 1,000 hours operating at RCWV with duty cycle 1.5 hours “ON”, 0.5 hour “OFF” at $70^\circ\text{C}\pm 2^\circ\text{C}$ ambient.
	$\pm 5\%$	$\pm(3.0\%+0.005\Omega)$	
Low Temperature Storage	$\pm 1\%$	$\pm(1.0\%+0.005\Omega)$	4.23.4 Lower limit temperature , for 2H.
	$\pm 5\%$	$\pm(3.0\%+0.005\Omega)$	
High Temperature Exposure	$\pm 1\%$	$\pm(1.0\%+0.005\Omega)$	4.23.2 Upper limit temperature , for 16H.
	$\pm 5\%$	$\pm(3.0\%+0.005\Omega)$	
Leaching	No visible damage		J-STD-002 Test D Samples completely immersed for 30 sec in solder bath at 260°C

12. Packing of Surface Mount Resistors

12.1 Dimension of Paper Taping : (Unit: mm)

Type	A	B	C	$\Phi D_{-0}^{+0.1}$	E	F	G	W	T
WR08	± 0.2	± 0.2	± 0.05	± 0.1	± 0.1	± 0.05	± 0.1	± 0.2	± 0.1
WR12	1.65	2.40	2.0	1.5	1.75	3.5	4.0	8.0	0.81
WR12	2.00	3.60	2.0	1.5	1.75	3.5	4.0	8.0	0.81

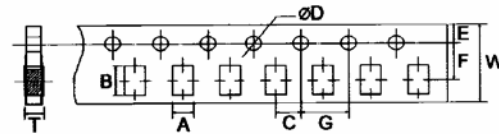

12.2 Dimension of plastic taping: (Unit: mm)

Type	A	B	C	$\Phi D_{-0}^{+0.1}$	$\Phi D1_{-0}^{+0.25}$	E	F	G	W	T
WR20	± 0.2	± 0.2	± 0.05	± 0.1	± 0.1	± 0.1	± 0.05	± 0.1	± 0.2	± 0.1
WR20	2.9	5.6	2.0	1.5	1.5	1.75	5.5	4.0	12	1.0
WR18	3.5	4.8	2.0	1.5	1.5	1.75	5.5	4.0	12	1.0
WR25	3.5	6.7	2.0	1.5	1.5	1.75	5.5	4.0	12	1.0

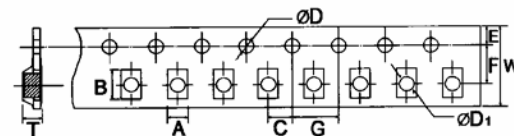

12.3 Dimension of Reel : (Unit: mm)

Type	Taping	Qty/Reel	A ± 0.5	B ± 0.5	C ± 0.5	D ± 1	M ± 2	W ± 1
WR08	Paper	5,000pcsl	2.0	13.0	21.0	60.0	178	10
WR12	Paper	5,000pcs	2.0	13.0	21.0	60.0	178	10
WR20	Embossed	4,000pcs	2.0	13.0	21.0	60.0	178	13.8
WR18	Embossed	4,000pcs	2.0	13.0	21.0	60.0	178	13.8
WR25	Embossed	4,000pcs	2.0	13.0	21.0	60.0	178	13.8

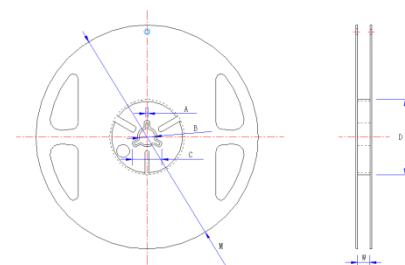

13. Note

13.1. UNI-ROYAL recommend products store in warehouse with temperature between 15 to 35°C under humidity between 25 to 75%RH.

Even under storage conditions recommended above, solder ability of products will be degraded stored over 1 year old.

13.2. Cartons must be placed in correct direction which indicated on carton, otherwise the reel or wire will be deformed.

13.3. Storage conditions as below are inappropriate:

- Stored in high electrostatic environment
- Stored in direct sunshine, rain, snow or condensation.
- Exposed to sea wind or corrosive gases, such as Cl_2 , H_2S , NH_3 , SO_2 , NO_2 , etc.



14. Record

Version	Description	Page	Date	Amended by	Checked by
1	First version	1~7	Mar.20, 2018	Haiyan Chen	Nana Chen
2	Modify characteristic	5~6	May.02, 2018	Haiyan Chen	Nana Chen
3	1.Modify the resistance range of WR12 2. Modify characteristic	3 5~6	Feb.13, 2019	Haiyan Chen	Yuhua Xu
4	Modify resistance range and temperature coefficient	3 5	Apr.24, 2019	Haiyan Chen	Yuhua Xu

© Uniroyal Electronics Global Co., Ltd. All rights reserved. Specification herein will be changed at any time without prior notice

X-ON Electronics

Largest Supplier of Electrical and Electronic Components

Click to view similar products for [Thick Film Resistors](#) category:

Click to view products by [Uniroyal](#) manufacturer:

Other Similar products are found below :

[MCR03EZPFX3162](#) [MCR004YZPJ332](#) [201007J022KT4E](#) [201007F1653T4E](#) [201007F6652T4E](#) [0603WAF137KT5E](#) [RTT204702FTE](#)
[RTT203000FTE](#) [RTT2056R0FTE](#) [CR2010F470KE04Z](#) [RTT018451FTH](#) [RTT021802DTH](#) [0402WGF510LTCE](#) [0201WMJ0200TEE](#)
[TR0603B26K7P0550Z](#) [0201WMF5102TEE](#) [1210W2J047KT5E](#) [YLR12-2-4F-W](#) [HOT\(0.25x1.3\)-3.2-0R-I](#) [HOT\(0.4x1.5\)-5.2-0R-I](#)
[HoT\(0.45x1.5\)-8.2-0R-I](#) [0201WMF1103TEE](#) [0201WMF7152TEE](#) [1210W2J0124T5E](#) [201007J010LT4E](#) [201007J0360T4E](#) [201007J0430T4E](#)
[0805W8F931KT5E](#) [1206W4F5231T5E](#) [1210W2J0620T5E](#) [201007J0822T4E](#) [0201WMF1005TCE](#) [0201WMF1212TCE](#) [0201WMF1373TCE](#)
[0201WMF1400TCE](#) [0201WMF2000TEE](#) [0201WMF2001TCE](#) [0201WMF226JTCE](#) [0201WMF2672TCE](#) [0201WMF2803TCE](#)
[0201WMF357JTCE](#) [0201WMF3743TCE](#) [0201WMF430JTCE](#) [0201WMF4990TCE](#) [0201WMF5104TCE](#) [0201WMF510JTEE](#)
[0201WMF5110TCE](#) [0201WMF6652TEE](#) [0201WMF6812TCE](#) [0201WMF8200TCE](#)